



LOYTEC Products

Product Catalog 2024



Dear valued customer,

LOYTEC keeps striving for innovations in the field of building automation and building management. The focus is on maximizing energy efficiency, comfort, flexibility, and transparency regarding energy consumption. Synergies that arise from the integration of different systems create potentials for savings that should be ideally leveraged. LOYTEC meets these challenges and transforms the resulting requirements into best possible solutions. The results are innovative, consistent, and dedicated products made in Austria that are sold globally.

LOYTEC relies solely on open communication protocols emphasizing communication via Ethernet/IP and WLAN/IP and is further focused on the international standards ISO 16484-5 (BACnet), ISO/IEC 14908-1 (LON), ISO/IEC 14543 (KNX), and OPC. Of course, also EnOcean (radio), M-Bus (meter), Modbus, SMI (sun blinds), and MP-Bus are supported.

LOYTEC's groundbreaking JavaScript-based IoT integration is now an integral part of the programmable LOYTEC controllers, automation servers, gateways, and L-VIS touch panels. The IoT feature allows the connection of devices to a cloud service for uploading data or to access information from the internet like weather forecast services. Typical applications include the integration of third-party devices such as EV charger (OCPP), video projectors, A/V systems, Smart TV or even Alexa and friends.

The L-DALI product line of LOYTEC demonstrates innovation. With full commitment to the new DALI 2.0 standard, new L-DALI multi-sensors, button modules and relay modules were created.

LOYTEC shows continuity in the maintenance of the current L-INX automation server device generation. Our top class flagship is the LINX-153, which provides six communication interfaces at once. LINX-215 represents the up-to-date middle class of automation servers, which keeps up with the top class function-wise. Both classes of devices provide all protocols of the LOYTEC portfolio and feature Dual Ethernet and local operation via LCD and jog-dial. Naturally, all network security functions are also implemented. "Packed with power" is the name of the game.

The product family of LROC-400 Room Controllers is a showcase of LOYTEC's capabilities in innovative technology. Full integration of all systems in a room is self-evident. For this purpose LROC-400 simultaneously provides all protocols of the LOYTEC product portfolio and also features sufficient in- and outputs to extensively control up to 8 room segments.

L-ROC is configured and programmed in L-STUDIO which offers methods and functions that enable highly efficient work. The high performant LROC-400 hardware in combination with L-STUDIO is a performance show made by LOYTEC that is not only on a high technical level, but also opens many doors for commercial use.

The LOYTEC building management System LWEB-900 faces continuous development. The new multi-site support allows to optimally manage and control several sites hierarchically. With the support of the ONVIF standard, web cams are now easy to integrate and become an integral part of the operations management. Through the use of TSL secured web services for connecting the management system to LOYTEC devices within a building, the server necessary for the system can also be hosted in a secured data center. Of course, LWEB-900 can also be operated as a BACnet Operator Workstation that allows to integrate devices of third parties via BACnet/IP.

Immerse yourself into the world of LOYTEC and be inspired by our product solutions. Convince yourself of our innovativeness and enjoy the offered technological benefits to experience tomorrow's building automation already today.

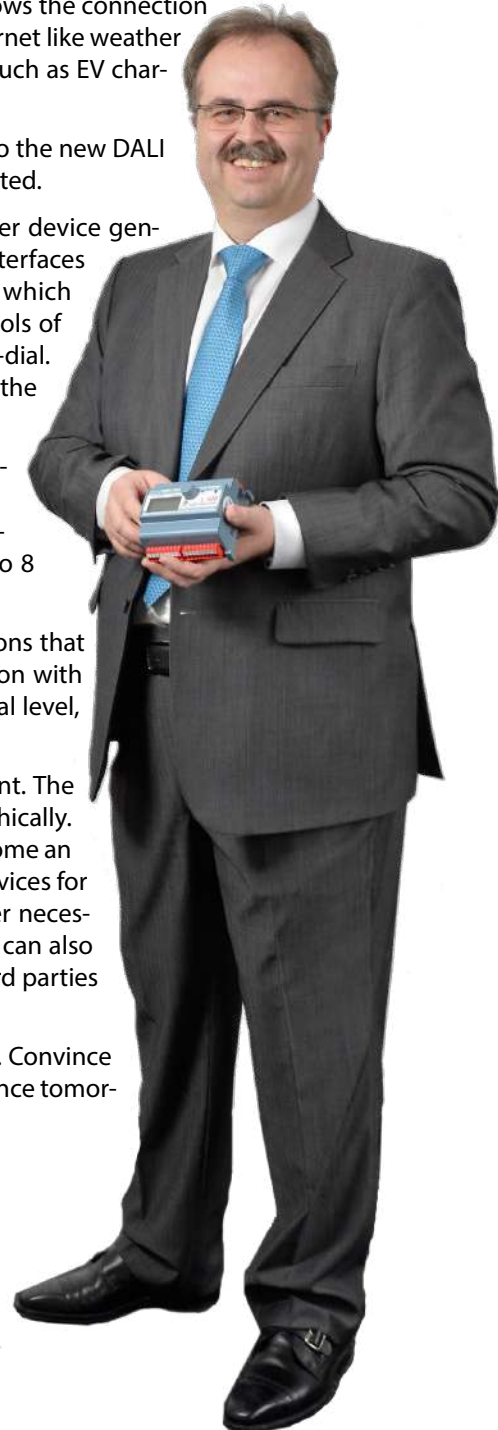

Hans-Jörg Schweinzer, CEO
LOYTEC electronics GmbH

Overview	6
LOYTEC Product Overview	6
Functions	7
AST™ Functions	8
Communication	10
Gateway	16
L-IOB I/O	17
Programming Functions	18
Device Management	19
Visualization / Operate and Monitor	20
L-WEB Building Management & L-STUDIO	23
Integrated Building Management System	24
LWEB-900	24
LWEB-803	31
LWEB-802	33
Engineering Tool	35
L-STUDIO 3	35
L-ROC Room Automation	37
L-ROC Overview	38
LROC-102	39
LROC-400, LROC-401, LROC-402	45
L-INX Automation Servers	53
L-INX Overview	54
LINX-153, LINX-154	55
LINX-215	60
L-IOB I/O Controllers & Modules	63
L-IOB I/O Controllers	64
LIOB-585	66
L-IOB I/O Controller	69
LIOB-586/587/588/589	69
LIOB-590	73
L-IOB Room Controller	75
LIOB-591	75
L-IOB I/O Controller	78
LIOB-592	78
LIOB-593	81
LIOB-594	84
LIOB-595	87
LIOB-596	90
Relay Interface	93
LOYREL-816	93
TRIAC Interface	94
L-TRIAC16	94
Voltage / Current Converter	95
LOYCNV-VA8	95
Voltage Converter	96
LOYCNV-PT1008	96

Content

L-IOB I/O Modules	98
LIOB-Connect I/O Module	100
LIOB-100/101/102/103/110/112 V2	100
LIOB-FT I/O Module	102
LIOB-150/151/152/153/154 V2	102
LIOB-IP852 I/O Module	104
LIOB-450/451/452/453/454 V2	104
LIOB-BIP I/O Module	106
LIOB-550/551/552/553/554 V2	106
LIOB-BIP I/O Module	108
LIOB-560	108
LIOB-BIP I/O Module	110
LIOB-562	110
General Input and Output Specification of LOYTEC devices	112
Gateways	115
L-GATE, L-INX, L-DALI	116
L-GATE Gateway	117
LGATE-952	117
LGATE-902	120
LINX-102, LINX-103	123
LINX-202, LINX-203	126
Graphical Operator Panels LPAD-7, L-VIS & L-STAT	129
LPAD-7 Programmable Touch Panel	131
LPAD-7	131
L-VIS Overview	136
L-VIS Touch Panel	137
LVIS-3ME7-Gx/3ME12-A1/3ME15-A1/3ME15-Gx	137
L-STAT Room Operator Panel	141
LSTAT-800, LSTAT-801, LSTAT-802	141
L-STAT Remote EnOcean Antenna	147
LSTAT-810-G3-L0, LSTAT-820-G3-L0, LSTAT-830-G3-L0	147
L-DALI Lighting Control	149
L-DALI Overview	150
CEA-709/DALI Controller	151
LDALI-3E101-U, LDALI-3E102-U, LDALI-3E104-U	151
BACnet/DALI Controller	156
LDALI-ME201-U, LDALI-ME202-U, LDALI-ME204-U	156
Programmable DALI Controller	161
LDALI-PLC2/LDALI-PLC4	161
L-DALI Power Supply	166
LDALI-PWR1-U	166
LDALI-PWR2-U, LDALI-PWR4-U	167
Infrared Remote Control	168
L-RC1	168
L-DALI Multi-Sensor	169
LDALI-MS2-BT / LDALI-MS3-BT / LDALI-MS4-BT	169
L-DALI Phase-Cut Dimmer Module	172
LDALI-PD1	172

L-DALI PWM module	174
LDALI-PWM4-x	174
L-DALI Pushbutton Coupler	176
LDALI-BM2	176
L-DALI Relay Module	177
LDALI-RM5, LDALI-RM6	177
LDALI-RM8	179
L-DALI Sunblind Module	181
LOY-DALI-SBM1	181
Routers, NIC	183
CEA-709/IP-852 Router	184
LIP-1ECTC, LIP-3ECTC, LIP-33ECTC, LIP-3333ECTC	184
BACnet/IP Router	186
LIP-ME201C, LIP-ME202C, LIP-ME204C	186
NIC Network Interface	189
NIC709-IP3E100C, NIC709-IP1E100C, NIC709-USB100, NIC852-SW, NIC852	189
LPA – CEA-709 Protocol Analyzer	191
LPA-SET-USB, LPA-USB, LPA-IP, LPA-SW, LPA-IP-SW	191
Interfaces	193
M-Bus Level Converter	194
L-MBUS20, L-MBUS80	194
MP-Bus Interface	195
LMPBUS-804	195
KNX TP1 Interface	196
LKNX-300	196
L-ENO EnOcean Interface	197
LENO-800, LENO-801, LENO-802	197
L-WLAN Wireless LAN Interface	198
LWLAN-800	198
LTE Interface	199
LTE-800	199
L-SMI Standard Motor Interface	200
LSMI-800, LSMI-804	200
RS-232 Interface	202
LRS232-802	202
Accessories	203
L-POW Power Supply	204
LPOW-2415A, LPOW-2415B, LPOW-2460B	204
System Distribution Box	206
LBOX-600, LBOX-ROC1, LBOX-ROC2	206
L-Term Network Terminator	207
LT-03, LT-13, LT-33	207
LT-04, LT-B4	208
L-IOB Adapter	209
LIOB-A2, LIOB-A4, LIOB-A5	209
Actuators	210
L-ACT101-MP, L-ACT102-MP	210

Content

Managed Industrial Ethernet Switch	211
LOYDVS-110W02-3SFP	211
Unmanaged Fast Ethernet Switch	212
LOYDVS-008I00	212
I/O Extension Module	213
LOYDVP16SM11N	213
Modbus Remote I/O Communication Module	214
LOYRTU-485	214
LOYBT Temperature Sensor	215
LOYBT-TEMP1	215
Indoor air quality sensor	216
LOYUNO-L	216
Device Dimensions, Certificates	217
Dimensions of the devices in mm and [inch]	218
Certificates	259
Trainings	265
Brochures	266
LOYTEC Competence Partner	268

LOYTEC Product Overview

LWEB-900 Building Management System

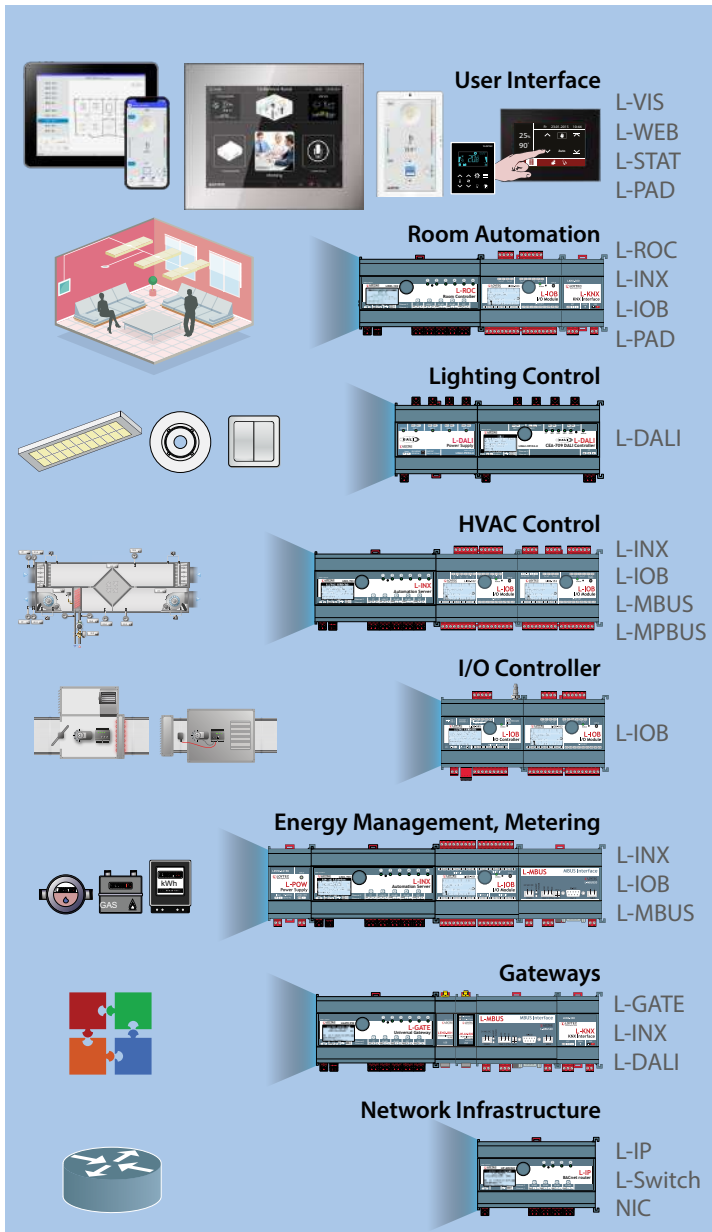
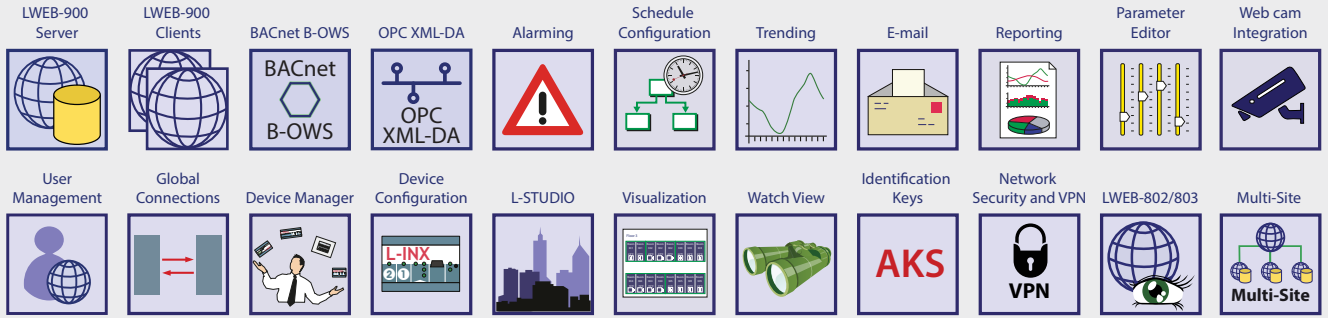

	LON	BACnet	KNX	EnOcean	Bluetooth	DALI	SMI	Modbus	M-Bus	MP-Bus	OPC	Programmable	IoT
User Interface	✓	✓			✓			✓			✓	✓	✓
Room Automation	✓	✓	✓	✓	✓	✓	✓	✓	✓	✓	✓	✓	✓
Lighting Control	✓	✓		✓	✓	✓	✓	✓			✓	✓	✓
HVAC Control	✓	✓	✓	✓		✓		✓	✓	✓	✓	✓	✓
I/O Controller	✓	✓		✓		✓		✓		✓	✓	✓	✓
Energy Management, Metering	✓	✓	✓	✓				✓	✓	✓	✓	✓	✓
Gateways	✓	✓	✓	✓		✓	✓	✓	✓	✓	✓		✓
Network Infrastructure	✓	✓									✓		

Functions

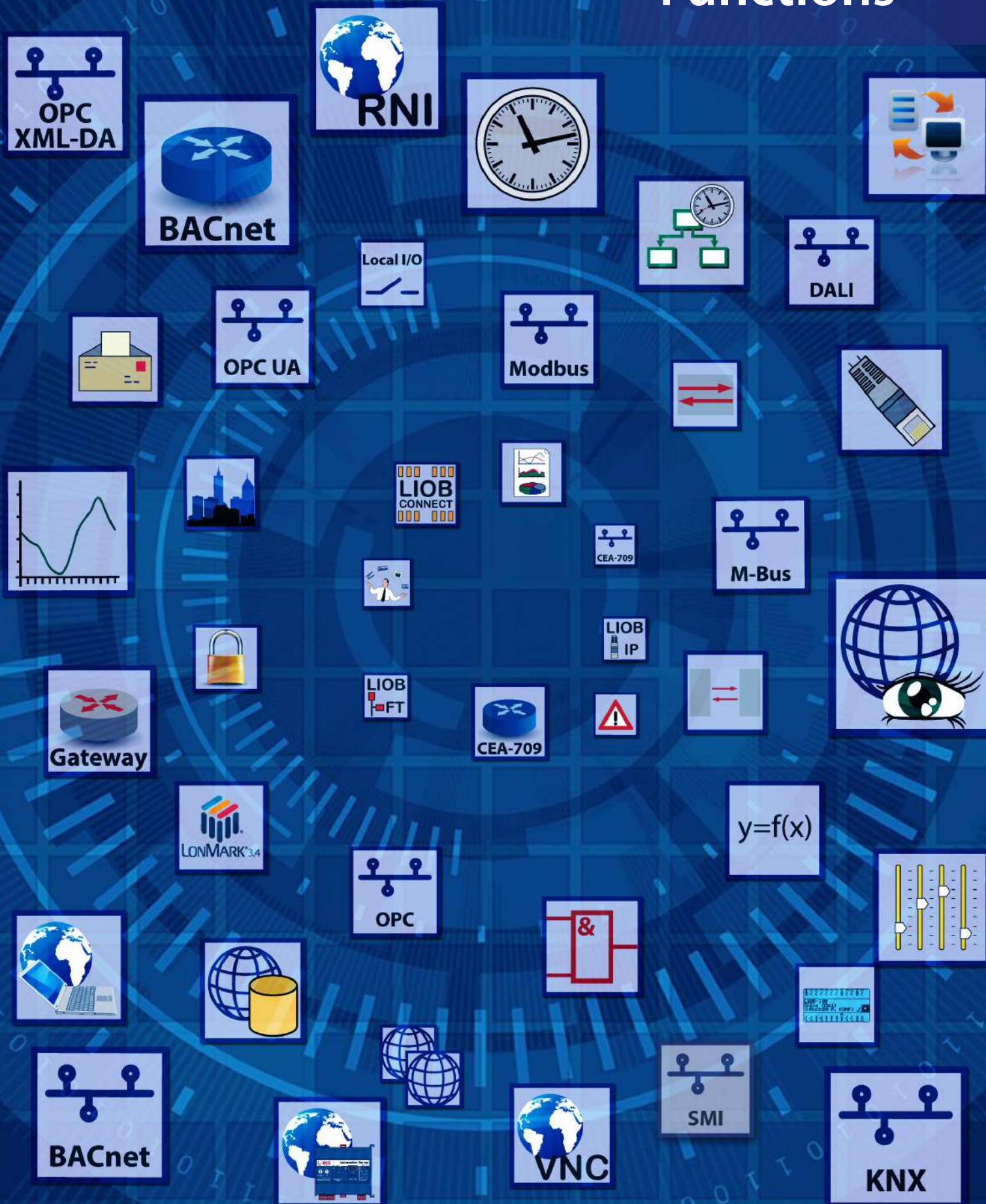

Functions

Datasheet #89088604

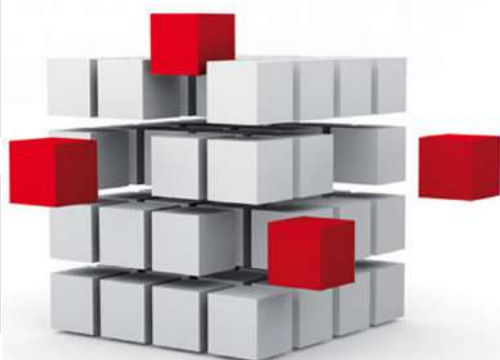

LOYTEC offers a wide range of products for various applications in building automation. Those application-centric products often combine an entire set of different functions on one single device (L-INX Automation Servers, IP-capable L-IOB I/O Modules and Controllers, L-ROC Room Controllers, L-GATE Gateways, L-VIS Touch Panels). This enables a given product to be used for different tasks. For example, the L-GATE as a typical gateway also has the ability to host a graphical user interface to dynamically visualize a site or record historic data in trend logs. L-INX Automation Servers are primarily programmable controllers but can also be used as gateways depending on the available protocols.

We have high quality standards in research, development, and production of our products. In order to offer the same high standards to our customers, the programmable controllers may only be purchased by trained staff of companies that are enrolled in the LOYTEC Competence Partner Program.

For all functions, LOYTEC ensures common workflows for configuration and operation. The workflow for configuration of certain functions is the same, regardless which device

is used. This applies for integration in different communication network technologies, creating schedules, alarm conditions, trend logs, and even for the design of graphical projects. For an efficient workflow the user can – depending on the network technology – create single data points or entire device templates via a network scan or file import. The use of a single configuration tool for a range of product models such as the L-INX Automation Servers, L-IOB I/O Modules, L-IOB I/O Controllers, and L-GATE Gateways, reduces the learning curve notably when working with LOYTEC products.

The combination of different functions on a single device and the common workflows for configuration and operation offer a maximum of flexibility when selecting LOYTEC products for various application requirements. On the following pages we give an overview on the offered functions. For more detailed information on the presented functions please refer to the respective product manuals, which are available for download on our web site. The functions are represented by symbols, which are referred to by the respective product descriptions later in the catalog.

AST™ Functions

The acronym AST™ stands for the combination of alarming (alarm management), scheduling, and trending (historic data recording) functions, which are available as automation functions on LOYTEC devices (L-INX Automation Servers, IP-capable L-IOB I/O Controllers, L-ROC Room Controllers, L-GATE Gateways, L-VIS Touch Panels). The AST™ functions can therefore be distributed into the field and are available exactly where they are needed in a building automation system. AST™ functions can be seamlessly integrated with the L-WEB building management software. Also graphical user interfaces like LWEB-802/803, the building management system LWEB-900 and the L-VIS Touch Panels provide access to the distributed AST™ functions.

Alarming (Alarm Management)



On a LOYTEC device it is possible to define alarm conditions for each data point. This can be done independently of the underlying communication technology (CEA-709, BACnet, DALI, M-Bus, Modbus, KNX, etc.) or the underlying, physical data point of a L-IOB I/O Module.

Alarms generated by these alarm conditions are reported to a generic alarm server, which is also independent of the network technology. The alarm server collects alarm records and is the interface for remote access to those local alarms. Alarm records contain information on the alarm source data point, the alarm value, an alarm message, alarm type (off-normal, limit, fault), alarm priority, and alarm state (alarm active, acknowledged, inactive). The alarm message of the record can be user-defined and extended by variable placeholders.

LOYTEC devices with a BACnet interface support BACnet alarms with intrinsic reporting. BACnet alarm servers are mapped to BACnet notification class (NC) objects. Alarm conditions can be defined for analog input, output, and value objects (AI, AO, AV), for binary input, output, and value objects (BI, BO, BV) and for multi-state input, output, and value objects (MSI, MSO, MSV). More than this, alarm records from generic alarm servers can be reported to BACnet alarm servers and can be exposed to notification class objects. This allows the reporting of alarm conditions from other communication technologies to BACnet. Using client mappings, LOYTEC devices can also access remote BACnet notification class objects, for instance to receive alarms from third-party devices.

LOYTEC devices for LonMark Systems (CEA-709) support the transmission of alarms via the LonMark node object's nvoAlarm (SNVT_alarm) and nvoAlarm_2 (SNVT_alarm_2). This allows other devices that support the LonMark alarm notifier profile to receive alarms sent by LOYTEC devices. The acknowledgement of alarms in the LonMark alarm server is defined in the LonMark specification and works with the RQ_CLEAR_ALARM mechanism. Alarms from generic alarm servers can be reported to the LonMark alarm server (mapped to the LonMark node object). This way alarm conditions of data points from other network technologies can be reported to a LonMark System.

Alarms of the different alarm servers can be displayed in LWEB-900, LWEB-802/803, L-VIS Touch Panels or in the device's integrated web interface using the built-in web server.

The alarming feature also includes the recording of alarm transitions in an alarm log on the LOYTEC device. The alarm log works as a ring buffer and its size can be configured. The alarm log can be viewed on the web interface of the LOYTEC device and be exported to a CSV file. The alarm log can also be transmitted as a CSV file e-mail attachment or be downloaded from the device via FTP access.

Scheduling



Scheduling refers to changing the value of data points on a timely basis using a time schedule. The schedule contains a weekly schedule, exception days (e.g. holidays), and date periods (e.g. vacation time). The scheduling feature works locally on LOYTEC devices and can be enabled depending on an enable data point.

All LOYTEC devices supporting the scheduling function feature a built-in battery-buffered Real Time Clock (RTC). Schedules can change the state of a binary data point or the value of an analog data point. This occurs independently of the underlying communication technology (CEA-709, BACnet, DALI, M-Bus, Modbus, KNX, etc.) or the underlying, physical data point of a L-IOB I/O Module.

Generic schedulers – like generic trends and alarms – can be created, that are neither CEA-709 nor BACnet objects. They are beneficial for creating technology-independent applications. Generic schedulers can write to any technology as well as data point favorites and are the ideal solution if configured via LWEB-900 only.

LOYTEC devices with a BACnet interface use the standardized BACnet schedule and calendar object to map the schedule. A separate BACnet schedule object is created for each schedule. BACnet calendar objects are used for defining exception days. The BACnet schedule object allows scheduling of a single value at a time (multistate, analog, or binary). More than one scheduled value or different data types at a time are not possible. Using the client mapping function, it is possible to access remote BACnet scheduler objects. This allows reading and modifying schedules of third-party devices.

LOYTEC devices for LonMark Systems (CEA-709) support CEA-709 schedulers and CEA-709 calendars via standard LonMark objects. For CEA-709 schedules, more than one data point can be configured, possibly of different data type, for which a set of different values can be scheduled at a time.

Schedules are executed autonomously on LOYTEC devices. The schedules and scheduled values can be viewed and configured in LWEB-900, LWEB-802/803, L-VIS Touch Panels, or on the device's web interface using the built-in web server. The distributed schedules on LOYTEC devices can be managed by the LWEB-900 Building Management System. LWEB-900 allows grouping schedules, building a hierarchical structure, and configuring schedules efficiently.

Trending (Historic Data Logging)



Generic trend logs are technology-independent and allow the recording of historic data values over time. The recording of data point values occurs at fixed intervals, on a defined change-of-value, or is triggered by a trigger data point. Recording intervals can be aligned to the wall-time. For example, different trend logs with 15 minutes intervals can record synchronously aligned to the top of the hour. For each data point, a change-of-value condition can be defined on the LOYTEC device. Trends operate independently of the underlying communication technology (CEA-709, BACnet, DALI, M-Bus, Modbus, KNX, etc.) or the underlying, physical data point of a L-IOB I/O Module. Trend logs can record local and remote data points of other, distributed devices. The capacity of a trend log and the storage mode (linear or ring buffer) can be configured. Devices that support SD cards or have a USB port also allow the storage of trend log data on external memory. The time of backing up trend logs can be triggered by the user on the LCD display or by defined, automatic trigger conditions.

LOYTEC devices with a BACnet interface can also use BACnet trend log objects for historic data recording. These objects can be accessed over the BACnet network and expose trend data to other BACnet devices and operator workstations (OWS). Each BACnet trend log object can record data for a single data point only. The recorded data point is limited to the BACnet technology, either to a local BACnet object or to a remote BACnet object (configured by a client mapping).

LOYTEC devices for LonMark Systems (CEA-709) use generic trend logs. There exists no LonMark functionality that allows transparent LonMark access to trend log data.

Trend log data of the different trend log objects can be displayed by LWEB-900, LWEB-802/803 and L-VIS. Trend data can be viewed either in a table view or in a trend graph. In addition, the LWEB-900 server allows long-term storage of the historic trend data. For doing so, the recorded data is periodically read out from the device and stored in a database. If no permanent IP connection should exist between the L-WEB server and the respective LOYTEC devices, the devices can be configured to send trend data automatically as an e-mail attachment to the L-WEB server. Trend data can also be exported as a CSV file (via FTP access), or stored to SD card or USB memory, if the device supports it.

For certain applications, historic values of a given base data point, both recent and far into the past, can be of interest. This can be accomplished with historic filters. They allow processing historic values of the base data point according to a filter function. One or more such functions can be defined per base data point. The result of the historic filter is written to "historicFilter" property relations. For each historic filter function, a time period can be defined at which the base value is sampled, e.g., every first of the month at midnight, and how many samples ago. Historic filters can be created for any analog, binary, or multi-state data point. It is not necessary to create a trend log.

Functions

Communication

IoT



The Internet of Things has brought forward an off-spring of devices with Web-based interfaces, such as Multimedia projectors, A/V systems, Smart-TVs, or smart light bulbs. LOYTEC's groundbreaking JavaScript-based IoT integration allows to integrate them all. In short: If you can control it via app, you can integrate it into the building automation system or touch panel interface.

Typical applications are meeting rooms or auditoriums with scene control of lighting and shading, integration of third-party devices, and operation of multi-media equipment by the touch of a single button. Similar products from the consumer sector like a Sonos® audio system, Philips Hue lights or Alexa and friends can be connected to the LOYTEC building control system. Some LOYTEC devices require the L-IOT1 software license.

The IoT function (Node.js) allows connecting the system to almost any cloud service, either for uploading historical data to analytics services, delivering alarm messages to alarm processing services or operating parts of the control system over a cloud service (e.g., scheduling based on Web calendars or booking systems). Processing Internet information such as weather data in forecast-based control is also possible. Finally, the JavaScript kernel also allows implementing serial protocols to non-standard equipment in primary plant control.

Benefits:

- Easy integration of multi-media equipment into the building control system
- Connect consumer products like Sonos®, Philips Hue, Alexa and friends
- Uploading data to cloud services for further processing
- Scheduling based on Web applications (e.g., Google Calendar)
- Implementing custom serial protocols

E-mail Notification



The integrated e-mail client allows for the transmission of messages based on a timely basis or triggered by events. Message texts can be multi-line and consist of static text and variable placeholders, which are evaluated at the time of transmission and insert values into the text. Furthermore, alarm logs and trend logs can be automatically transmitted as e-mail attachments in CSV file format.

The number of transmitted e-mails can be limited. Using a trigger data point, the e-mail transmission can be invoked on a timely basis or event-based. In case an e-mail could not be delivered, retransmissions are tried every 30 minutes up to 24 times.

SMS Notification



Together with the LTE-800 interface the transmission of SMS directly from the device becomes possible. SMS can contain configurable text and variable placeholders that resolve to data point content at the time of transmission. SMS can be sent on a timely basis or triggered by events such as alarms. This makes it easy to add an SMS alarm notifier to the device. The transmission of SMS can be limited to burst and long-term transmission rates.

Ethernet (Ethernet Switch)



Ethernet summarizes a variety of networking technologies, software (protocols) and hardware (cable, hubs, interface cards, etc.) for wired, local area networks (LANs). Originally published in 1983 as the IEEE 802.3 standard, Ethernet has evolved to today's most used LAN technology. As a packet-switched network, Ethernet belongs to the layers 1 and 2 of the ISO/OSI layer model and defines addressing and media access. Ethernet is a common basis for networking protocols such as TCP/IP and UDP/IP and is able to multiplex several application protocols at the same time (e.g. HTTP, FTP, IP-852, BACnet/IP, KNXnet/IP).

LOYTEC devices with an Ethernet interface use 100Base-T (Fast Ethernet) at 100 Mbit/s and an RJ45 jack.

LOYTEC devices featuring two Ethernet ports can either be configured to use the internal switch to interconnect the two ports or every port is configured to work in a separate IP network.

When the Ethernet ports are configured for two separate IP networks, one port can be connected for instance to a WAN (Wide Area Network) with enabled network security (HTTPS) while the second port can be configured to be connected to an insecure network (LAN) where the standard building automation protocols like BACnet/IP, LON/IP, or Modbus TCP are present. These devices also feature firewall functionality of course to isolate particular protocols or services between the ports.

Using the internal switch, a daisy chained line topology of up to 20 devices can be built, which reduces costs for network installation. The IP switch also allows the setup of a redundant Ethernet installation (ring topology), which increases reliability. The redundant Ethernet topology is enabled by the Rapid Spanning Tree Protocol (RSTP), which is supported by most managed switches.

Network Security and VPN



Integral part of the LOYTEC hardware is a configurable firewall, which can be enabled and configured over the built-in web server, over OPC XML-DA, or OPC UA. The built-in web server is accessed via the secure HTTPS protocol. A pre-installed certificate allows a quick setup and can later be replaced by a locally generated certificate or by a certificate issued by a certification authority. Data communication is encrypted by TLS encryption methods. The use of secure certificates prevents man-in-the-middle attacks. Furthermore, the OPC UA server provides a secure alternative to OPC XML-DA. It uses the installed server certificate and authorizes OPC clients by certificates.

LOYTEC devices can also be operated as part of a virtual private network (VPN) based on the OpenVPN technology. In a VPN setup, the device connects to a VPN server with an authenticated VPN certificate. The VPN provides a secured network channel that can carry any of the IP-based protocols. In combination with a VPN server on a public address, VPN devices can be accessed without having a public address. This provides a secure alternative to NAT forwarding and makes secure access to remote sites very simple. In combination with LWEB-900, setting up a VPN on the device is as easy as entering the LWEB-900 VPN project PIN code. LWEB-900 fully automatically generates the VPN certificates and enrolls the device in its own VPN.

BACnet



BACnet (Building Automation and Control networks) is a standardized communication protocol for building automation (ISO 16484: Building automation and control systems – Part 5: Data communication protocol). It was developed at the end of the 1980s by the American Society of Heating, Refrigerating and Air-Conditioning Engineers (ASHRAE). Communication in the network is modeled on BACnet objects, which are exposed as server objects by a BACnet device. Other BACnet devices connect as clients to those BACnet server objects. The network integration is accomplished by vendor-specific configuration tools.

LOYTEC devices with a BACnet interface expose data via BACnet server objects (binary, analog, multi-state) and communicate through client mappings. Change-of-value (COV) events can trigger the transmission of values. The AST™ functions are available for BACnet scheduler, calendar, trend log, and notification class objects. Devices are connected to the BACnet network over BACnet MS/TP (twisted pair based on RS-485), BACnet/IP or BACnet/SC. BACnet objects are created in the LOYTEC Configurator tool using EDE import, online network scan, or manual creation.

As a default, BACnet objects use the ASCII character encoding on the device. This applies to the properties object name, object description, active/inactive text, state text, etc. Most third-party tools are compatible with this setting. To support international character sets, LOYTEC devices can be switched to use the encodings ISO 8895-1 (good for most Western Europe) or UCS-2 (good for Unicode character sets used in Japan).

All LOYTEC products with the BACnet/IP interface can act as BACnet time masters. It is possible to use the BACnet services TimeSynchronization and UTCTimeSynchronization in order to send out time synchronization events. This happens after a power-on reset of the device, when the system time is changed, or periodically. The system time on IP-based LOYTEC devices can be synchronized via NTP (Network Time Protocol), which allows the LOYTEC device – as a BACnet time master – to synchronize all registered BACnet devices in the network to the NTP time.

LOYTEC BACnet routers and BACnet devices with an integrated router can also function as a BACnet MS/TP slave proxy. A slave proxy answers BACnet Who-Is broadcast requests sent to slave devices on the MS/TP bus on behalf of them with appropriate I-Am packets. This covers the shortcoming of BACnet slave devices, which by definition cannot initiate communication by themselves. Using this feature, it is possible to find MS/TP slave devices in a BACnet network scan, which would not be possible without the slave proxy. LOYTEC BACnet routers, BACnet devices with an integrated router and L-GATE Gateways also have a built-in BACnet broadcast management device (BBMD) for managing BACnet/IP Internetworks that span across IP routers. BACnet models without the router function can register as a foreign device (FD) with other BBMDs.

All models with BACnet routing function can route between BACnet/IP, BACnet/SC and BACnet MS/TP.

The BACnet/SC node on LOYTEC devices provides a secure path for BACnet communication to a BACnet/SC hub. If configured with separate Ethernet ports, BACnet/IP can be operated on the LAN port which is isolated from BACnet/SC on the WAN port. Along with HTTPS this provides an extra layer of protection. Routing between BACnet/IP (LAN) and BACnet/SC (WAN) is possible.

BACnet devices with the BACnet MS/TP interface provide an additional remote MS/TP protocol analyzer. BACnet MS/TP packets are captured and can either be transmitted online to a Wireshark analyzer (sniffer program for analyzing network protocols available free of charge) or stored offline as a capture file on the device. This file can be downloaded over the web interface and opened later in Wireshark.

Other BACnet details such as the BACnet standardized device profile, the supported BIBBs (BACnet Interoperability Building Blocks) and the object properties are specified in the respective PICS (Protocol Implementation Conformance Statement) document. Apart from this, most LOYTEC devices are BTL-certified products that support the BACnet Building Controller (B-BC) profile (see also the related product descriptions).

Functions

BACnet Operator Workstation (B-OWS)



A BACnet Operator Workstation is designed to provide an operator with all the information and editing ability needed for managing a system on a daily basis. In addition to viewing and editing selected BACnet object, an Operator Workstation can display trends, schedules, and other specialized objects. It can also display reports and graphics. A BACnet Operator Workstation will notify the operator that an alarm has occurred, lets the operator acknowledge the alarm, provides a summary of alarms, and allows to adjust the alarm thresholds of analog objects.

CEA-709



By the end of the 1990s, LON (Local Operating Network) was standardized by the Consumer Electronics Association (CEA) under the title "Control Network Protocol" as CEA-709. Today, the CEA-709 protocol is a recognized international communication standard, namely ISO/IEC 14908. LOYTEC is highly experienced in the CEA-709 technology. LOYTEC developed its own technology to make devices talk on CEA-709 networks. LOYTEC technology includes chip sets and also the fully featured ORION Protocol stack which executes the CEA-709 protocol on powerful 32-bit micro controllers. All LOYTEC devices supporting CEA-709 connectivity make use of this powerful technology. Communication Objects (Network Variables) and functional profiles, standardized by LonMark International (www.LonMark.org), describe the communication interface of a LonMark device. Configuration properties (CPs) allow downloading and modification of device parameters. Network integration is accomplished by a network management tool, which is independent of the hardware manufacturer (e.g. NL220 or LonMaker®) and is used for device installation and creation of bindings between network variables, which are stored in a database. This allows for a clear separation between the application and the communication relations in the network. Configuration tools specific to LonMark nodes integrate as plug-ins into the network management tool and allow for fast and simple device configuration.

LOYTEC devices can be used in LonMark Systems with standard network variable types (SNVT) or user-defined network variable types (UNVT). The NVs can be created as static or dynamic network variables. Additionally, network variables of other LonMark nodes can be brought in via "external NVs", which are polled in a cyclical manner and written explicitly, without allocating and binding static or dynamic NVs on the LOYTEC device. LOYTEC devices also offer direct access to configuration properties of other LonMark nodes (using LonMark file transfer or read memory access methods). Both standard configuration property types (SCPTs) and user-defined configuration property types (UCPTs) are supported. Network variables are created in the Configurator tool (plug-in) by importing from a XIF file, scanning an LNS database, scanning a network online, or by manual creation. The AST™ functions alarming (alarm management) and scheduling are supported by using the respective LonMark profiles. Historic trend data can be logged by generic trend logs, which are technology-independent. Connectivity to the LonMark System is provided via IP-852 (100Base-T Ethernet) or TP/FT-10 channel with twisted pair or power line link. A sub-group of the LOYTEC devices is also LonMark certified (see product details).

DALI



DALI (Digital Addressable Lighting Interface) is a protocol for lighting control. It is standardized in Annex E of IEC 60929 and in the IEC 62386 standard. DALI is used as a lighting control sub-system for dimming and switching ballasts with a DALI interface. The ballasts can be controlled and queried independently via DALI short addresses. Also DALI groups can be freely assigned for controlling lighting scenes. The bi-directional communication allows DALI ballasts to report operational parameters and errors. Although DALI buttons and DALI multi-sensors are not covered by the DALI standard, they are interoperable depending on the manufacturer. The DALI standard specifies the testing of emergency lighting systems with a DALI interface. In a DALI system, the DALI master controls and queries the DALI devices in a master/slave manner. The multi-master capability also allows multiple DALI masters on the channel.

LOYTEC devices with a DALI interface can be integrated in a DALI network as DALI masters with a constant light controller (CLC) function. The configuration is done via the built-in web interface or for some models via the Configurator tool. AST™ functions for alarming (alarm management), scheduling, and trending (historical data recording) are also supported. As a DALI master, the devices can be installed autonomously. For the integration in building automation systems, the LOYTEC DALI master is equipped either with a BACnet interface or an interface to LonMark Systems.

DALI-2



The newer DALI-2 standard also covers switches, multi-sensors, bus power supplies, and control systems in addition to luminaires or ECGs. DALI-2 devices must be certified by the Digital Illumination Interface Alliance (DiiA) to be entitled to carry the DALI-2 logo. The DALI-2 certification promises significantly improved interoperability and additional functionality compared to older DALI systems on the market (version 1). LOYTEC recommends to use preferably DALI-2 certified devices. DALI and DALI-2 devices can be used simultaneously within one DALI channel.

EnOcean



EnOcean is a radio protocol for wireless products in building automation and is defined in the international standard ISO/IEC 14543-3-10. Switches, like sensors with EnOcean technology just need little energy for sending short radio signals. The energy is mainly produced from piezoelectricity during switching (energy harvesting), the energy of solar panels, or Peltier elements. This energy is sufficient for a batteryless, hence maintenance free operation of the sender. The wireless protocol is geared to transfer information energy efficiently yet highly reliable. Frequency bands with regional differences are used. Europe: 868.3 MHz, US/Canada: 902 MHz (also 315 MHz), and Japan: 928 MHz.

For the integration of EnOcean radio switches and sensors into LOYTEC devices with EnOcean support, an EnOcean interface of the LOYTEC product family L-ENO is necessary. The L-ENO interface is simply connected via a USB cable. Also the energy for the EnOcean interface is supplied via USB likewise automatic detection.

KNX



KNX is a communication protocol for building automation, which has been standardized internationally as ISO/IEC 14543-3 "Home Electronic Systems". KNX is used in the field of home automation and commercial building automation as well. In a KNX network, sensors and actuators are assigned to a set of communication objects. A communication object represents a value of a given type, for instance a temperature, a switch state, or a set point. The communication objects communicate via group addresses. Sensors transmit a message containing the current value to all actuators, which are member of the same group. In order to make devices of different manufacturers interoperable, the communication objects use a pre-defined set of standardized data point types (DPTs). Network integration in a KNX system is accomplished by a vendor-independent installation tool based on a database (ETS – Engineering Tool Software).

LOYTEC devices are integrated into the KNX system by exporting the database of communication objects from the Engineering Tool Software (ETS4/ETS5). ETS projects are imported by the LOYTEC Configurator tool. After the import of the KNX project, an overview of all available KNX data points is displayed. The desired data points for use can be chosen from this list. Later changes to the ETS project can be tracked and synchronized the same way. Once KNX data points have been integrated, they can be used for AST™ functions. The alarming (alarm management) is based on generic alarm servers. Scheduling of KNX data points is done using generic schedulers. Historic trend data of KNX data points can be logged by generic trend logs. The device communicates with the KNX system on KNX TP1 (twisted pair using an external KNX coupler) and on KNXnet/IP (Ethernet).

M-Bus



The M-Bus (Meter-Bus) is an established European standard (EN 13757-2, EN 13757-3) for remote meter reading. The M-Bus is a serial bus and employs a master/slave architecture. The M-Bus master can request data from several slaves (meters) on the network. The data transfer from master to slave is a voltage-modulated signal. The transfer from slave to master is a current-modulated signal. M-Bus devices can be bus-powered. The maximum number of nodes, which can be powered on the bus, depends on the M-Bus transceiver.

LOYTEC devices with M-Bus support are M-Bus masters and require an external transceiver for the integration of M-Bus meters. M-Bus data points can be created from an online network scan or offline by using M-Bus device templates, which have been previously created. The assignment of primary addresses to the M-Bus devices can be done in the Configurator tool. AST™ functions for alarming (alarm management), scheduling, and trending (historic data recording) also apply to M-Bus data points. Especially the historic data logging and cyclic polling of values is optimized for M-Bus meters.

Functions

Modbus (TCP, RTU)



Modbus is an open protocol and a de facto standard in the industry, which is based on a master/slave architecture. It was originally designed at the end of the 1970s for exchanging data between PLCs. Today, Modbus is still a widely used interface for integrating field devices into a system. Modbus devices communicate over a serial interface or over TCP/IP. Modbus TCP specifies communication over TCP/IP and is part of the IEC 61158 standard. Modbus devices use registers for data exchange, which are characterized by register type, address, and length. In addition, data type and byte order need to be specified in order to interpret Modbus data. The configuration is done by vendor-specific tools.

LOYTEC devices featuring a Modbus interface provide either Modbus TCP (Ethernet TCP/IP) or Modbus RTU (Remote Terminal Unit, based on RS-485) connectivity. Certain devices provide Modbus TCP and Modbus RTU at the same time. A Modbus interface can be operated either as a master or as a slave. The supported register types are: Read Discrete Inputs (2), Read Coils (1), Write Coils (5), Read Input Registers (4), Read Holding Registers (3), Write Holding Registers (6). For third-party integration, the vendor's datasheet needs to be consulted in order to manually create a configuration. The Modbus technology does not offer a method for scanning this information online, as it is known from other technologies. For Modbus devices that are online, the manual configuration can however be tested via an online test function. By looking at the extracted values, the respective data points can then be configured accordingly. Modbus device templates can be created, which allows the re-use of Modbus configurations and reduces errors in configuration. AST™ functions for alarming (alarm management), scheduling, and trending (historic data recording) also apply to Modbus data points.

More details on the communication behavior in a Modbus network can be found in the respective product manuals, which are available for download.

MP-Bus



The MP-Bus controls HVAC actuators for dampers, regulator valves or VAV air volume controls. It is a master/slave bus developed by Belimo®. There are no restrictions with respect to network topology. Permissible topologies include star, ring, tree and mixed configurations. The MP-Bus (multi point bus) consists of three conductors 24 V (AC or DC), GND and the MP data line.

SMI



The Standard Motor Interface (SMI) is a bus protocol used to control SMI sunblind motors for shading. On closer examination, the SMI is a digital interface with the benefit to parallelize the connection of roller shutters and sun protection drives. Furthermore, the automation controller gets feedback from the drives and the possibility of flexible parameterization. This allows telegrams to be exchanged over the consistent interface, from the controller to the drive and vice versa. SMI drives from different manufacturers are compatible with each other. For drives that operate on mains voltage, the drive and controller are connected by a 5-core cable which both supplies power and transmits data. Distances of even up to 350 m between the controller and drive are possible. Up to 16 drives per SMI channel can be connected. In this way, the hardware expense is reduced significantly in comparison with today's conventional technology, and the drive status can be queried by the sun protection controller.

The roller shutters and sun protection installations with SMI-drives can also be set up for operation without using a controller. The SMI drive has a setup mode. This mode can be activated using simple push buttons. The standard interface is also available for low-voltage drives. This means that interior sun protection installations can also be controlled intelligently and accurately. Low-voltage drives can be recognized by the SMI LoVo symbol.

OPC XML-DA



OPC is a de facto standard for interoperable communication in the automation industry, which is also often used for data exchange between management level and automation level in building automation. OPC is a set of different specifications and versions, which can be implemented independently of each other.

LOYTEC devices that support OPC have a built-in OPC server following the OPC XML-DA specification. When integrating the different communication technologies (CEA-709, BACnet, DALI, M-Bus, Modbus, KNX, etc.), OPC tags are automatically created without additional engineering effort and exposed via a web services. The OPC server provides data access via web services according to XML-DA, which are available over the same TCP port as the built-in web server. The OPC server exposes simple data points and complex AST™ functions as OPC tags for alarming (alarm management), scheduling, and trending (historic data recording). Since the OPC XML-DA standard does not specify corresponding tags for these functions, the OPC XML-DA server uses groups of OPC tags for exposing AST™ functions. Because web services are built for being routed across the Internet, the built-in OPC XML-DA server uses basic authentication for protection against unauthorized write access. Authentication requires the operator user and the respective password.

The L-WEB System uses OPC XML-DA communication (web services) for data exchange with LOYTEC devices. This allows for a hassle-free communication in the Intranet or Internet across firewalls and NAT routers. Also third-party applications such as SCADA systems can communicate as OPC XML-DA clients over the Intranet or Internet and access the built-in OPC server in a simple and secure way. The embedded OPC servers do not require extra PC hardware and can be distributed in the IP network.

OPC UA



The OPC server on LOYTEC devices, which support security, also features the OPC UA binary protocol, that exposes the same OPC tags as the OPC XML-DA server.

CEA-709 Router Function



The CEA-709 router function allows the transparent connection of two LonMark channels in a LonMark System. One of the channels can be a LonMark IP-852 (Ethernet/IP) channel. LOYTEC devices featuring IP-852 routing have a built-in IP-852 configuration server to configure and manage all IP-852 members on the channel.

BACnet Router Function



The BACnet router function allows the transparent connection of one BACnet/IP channel and one BACnet MS/TP channel. In addition, the router function implements a BACnet Broadcast Management Device (BBMD) and features Foreign Device support. For MS/TP slave devices it acts as a slave proxy.

Remote Access



LOYTEC devices offer remote access functions, which differ depending on the device model. All device settings can be modified, data point values can be queried, and configuration parameters can be modified. Apart from this, backup and restore of the device configuration is available. The same applies to parameters. Access to AST™ functions for alarming (alarm management), scheduling, and trending (historic data recording) is also supported, including reading out alarm logs and trend logs from the device via file transfer. The devices offer various analysis functions and statistical data for troubleshooting the used communication protocols. Programmable LOYTEC devices also provide online test functions for developing application programs.

Remote Network Interface (RNI)



The Remote Network Interface (RNI) function is available, if the LOYTEC device is configured to operate on the TP/FT-10 channel. In this mode, the LOYTEC device appears as a LOYTEC network interface and thus enables remote access to the TP/FT-10 channel over an Ethernet/IP connection. The network interface can be used together with LNS-based tools such as NL220 or LonMaker®, or as a native LOYTEC network interface. Furthermore, the RNI offers the “remote LPA” (LOYTEC Protocol Analyzer) feature for remote troubleshooting.

Wireless Local Area Network (WLAN)



WLAN refers to a local wireless radio network compliant to the common Standard IEEE 802.11. It extends all protocols of the wired Ethernet of corresponding LOYTEC devices to a wireless communication.

For network integration into a WLAN, the corresponding LOYTEC devices need to be connected with an L-WLAN interface via USB. The USB bus supplies the L-WLAN device with energy and enables an automatic detection. It is also possible to connect the LOYTEC device with an existing WLAN Access Point or create a WLAN Access Point.

Functions

LTE



The LTE function refers to supporting mobile communication standards for LTE, UMTS/HSPA+ and GSM/GPRS/EDGE. It is approved for:

- Carrier Certification: Deutsche Telekom/Verizon/AT&T/Sprint/U.S. Cellular/Telus/T-Mobile/Rogers*
- Regulatory Certification: SRRC/NAL/CCC/GCF/CE/FCC/PTCRB/IC/Anatel/IFETEL/KC/NCC/JATE/TELEC/RCM/NBTC/ICASA/IMDA
- Others: WHQL

The corresponding LOYTEC devices require the LTE-800 Interface connected to a USB port, which provides for an easy and simple solution to connect remote sites together via a VPN network and expose defined on-site services. The LTE interface can also be used to send SMS directly. Typical LTE applications include remote management, energy monitoring, site visualization, SMS alarm notification.

* Under development

Bluetooth



Bluetooth is a wireless communication technology in the UHF-range from 2.402-2.480 GHz. The IEEE standardized Bluetooth in IEEE 802.15.1, but no longer maintains the standard. Instead, the Bluetooth SIG oversees development, specification, qualification program and protects the trademarks. An important boost came with the introduction of Bluetooth Low Energy (BLE) as a subset of the Bluetooth v4.0 core specification. The entirely new protocol stack for rapid build-up of simple links is aimed at very low power coin-cell applications such as advertising beacons for indoor navigation and asset tracking.

LOYTEC multisensors and LOYTEC controllers with Bluetooth interface use BLE for asset tracking. In addition, LOYTEC multisensors are able to advertise either standard beacons with configurable identifier like iBeacon or EddyStone-UID which allows them to be perfectly integrated in indoor navigation systems. The L-WEB beacon enables secure room operation using the LWEB-App, as it restricts access to LWEB-900 functions to the close vicinity of the L-WEB beacon.

Bluetooth Mesh



In 2017 the Bluetooth SIG introduced Bluetooth Mesh on top of the Bluetooth v4.2 specification. In difference to classical Bluetooth and BLE, the new technology allows many-to-many communication by using advertising channels only. It is based on a forwarding mechanism (relay-function) and a publish/subscribe method for data exchange. In difference to BLE Bluetooth Mesh is not limited by the direct connection range. In 2023 a reworked version (called "Mesh 1.1") has been released by the Bluetooth SIG adding Mesh Protocol improvements like Directed Forwarding and Remote Provisioning as well as completely new specifications for Mesh Device Firmware Updates and Mesh Network Lighting Control Profiles.

The LOYBT product line is based on Bluetooth SIG qualified mesh and represents a wireless ecosystem for field devices.

Gateway

Gateway Function



The gateway functions allow data exchange between all available communication technologies. This is accomplished by using "connections" which connect data points of different technologies with each other. Both "1-to-n" and "m-to-1" connections are supported. Connections can contain simple or complex calculations. Different engineering units of connected data points are automatically converted. Connections can easily be created using templates. They are distinguished into local and global connections. Connections can be created manually or automatically using the Smart Auto-Connect™ feature of the Configurator tool. Especially the automated creation of connections reduces engineering effort and helps preventing configuration errors.

The Smart Auto-Connect™ feature works on a selection of source data points and creates target data points and the respective connections. In principle, Smart Auto-Connect™ can work with all available communication technologies as sources. However, only select technologies can be used as targets. Depending on the availability on the device model, data points can be created for the following technologies: CEA-709 (static NVs), BACnet (server objects), Modbus (slave registers) and user registers. A remarkable feature in this context is the automatic mapping of network variables to BACnet objects according to CEN/TS 15231:2005.

Local Connection



A “local connection” is used for connecting data points of different networking technologies, which are integrated on a single LOYTEC device.

Global Connection



“Global connections” provide similar functions as local connections, but can span across an IP network between two or more LOYTEC devices. A global connection creates a data cloud with a system-wide name. Data points which are added to a global connection can send values into the cloud or receive values from the cloud. This is entirely independent from the installation location or the original communication technology.

L-IOB I/O

L-IOB I/O Modules extend the L-INX Automation Servers, IP-capable L-IOB I/O Controllers, and L-ROC Room Controllers by adding physical inputs and outputs. Models with different I/O configurations and communication interfaces are available. L-IOB I/O Modules with LIOB-Connect can be directly connected in a daisy-chain. Those L-INX Automation Servers and L-ROC Room Controllers that support this feature, automatically detect which I/O modules are connected and map the corresponding data points. All L-INX and L-ROC models provide an additional way for connecting and integrating L-IOB I/O Modules via LIOB-FT (twisted pair) and L-IOB IP (Ethernet). L-IOB IP I/O Controllers are limited to the use of one additional L-IOB IP I/O Module.

LIOB-Connect



The LIOB-Connect port of a L-INX or L-ROC device allows connecting LIOB-10x Modules and provides a power and communication path without additional cabling. Regardless of the L-IOB type, up to 24 L-IOB I/O Modules are supported. This makes up to 24 LIOB-10x devices possible in a daisy chain. The first four LIOB-10x can be connected directly. Starting with the fifth LIOB-10x, the LIOB-Connect chain needs to be divided into two (or more) segments using LIOB-A4 and LIOB-A5 adapters.

Parameterization of the I/O modules is done by the Configurator software or over the web interface of the L-INX or L-ROC device. All parameter data is stored on the L-INX Automation Server or the L-ROC Room Controller and can be downloaded to the L-IOB Modules again if needed. When replacing a L-IOB Module, it is detected and integrated again automatically.

LIOB-FT



The LIOB-FT port allows operation of remote LIOB-15x Modules. These are connected by twisted pair cabling of up to 500 m length in free topology or more than 500 m in bus topology. The maximum number of supported LIOB-15x Modules depends on the L-INX Automation Server model, the L-IOB IP I/O Controller model, or the L-ROC Room Controller model.

Parameterization of the I/O Modules is done by the Configurator software or over the web interface of the L-INX, L-IOB IP or L-ROC device. All parameter data is stored on the L-INX Automation Server, the L-IOB IP I/O Controller, or the L-ROC Room Controller and can be downloaded to the L-IOB Modules again when needed. When replacing a L-IOB Module, it is detected and integrated again automatically.

LIOB-IP



The LIOB-IP port allows operation of remote LIOB-45x and LIOB-55x Modules. These are connected over Ethernet/IP (100Base-T). The maximum number of supported Modules depends on the L-INX Automation Server model, the L-IOB IP I/O Controller model, or the L-ROC Room Controller model. Communication across NAT routers is not supported.

Parameterization of the I/O Modules is done by the Configurator software or over the web interface of the L-INX, L-IOB IP, or L-ROC device. All parameter data is stored on the L-INX Automation Server, the L-IOB IP I/O Controller, or the L-ROC Room Controller and can be downloaded to the L-IOB Modules again if needed. When replacing a L-IOB Module, it is detected and integrated again automatically.

Local I/Os



All L-IOB I/O Controllers are equipped with local I/Os. The usage of local I/Os is completely transparent to the application. For the device’s logic program, it does not matter if the I/Os are local or remote. Parameterization of the Local I/Os is done by the Configurator software or over the web interface of the L-IOB I/O Controllers.

Functions

Programming Functions

IEC 61499 – L-STUDIO



The application project is created with the graphical programming system L-STUDIO (IEC 61499 standard), which allows programming using function blocks (FBs). In L-STUDIO, the programming environment comprises the entire project, where each controller in the IP network is treated as a computing resource with data points. L-STUDIO deploys the application to the networked controllers and creates the connections between them automatically. Event-oriented execution of the program allows for fast reaction times. As a novel approach to automation we name this "Cloud Control". An arbitrary set of functions can be mapped to a cloud of controllers. The strictly object oriented programming method allows for efficient reuse of previously implemented functions. A variety of debugging and watch functions allows for building-wide troubleshooting during run-time.

IEC 61131 – L-STUDIO



L-STUDIO has established itself as an integration platform for the L-ROC system for individual room control installations. With the new version L-STUDIO 3.0, LOYTEC is now taking the next step and extending the programming function by a development environment in accordance with the industry standard IEC 61131.

Mathematical Functions

$$y=f(x)$$

Math objects with user-defined formulas can execute mathematical functions on data points. A math object uses a number of data points as input variables (v_1, v_2, \dots, v_n) and calculates a result according to the formula. The result is written as an output to a number of data points. The calculation is executed each time one of the input data points changes its value. A result is calculated only if all inputs have a valid value.

Device Management

Backup / Restore



Depending on the device model, there exist several possibilities to backup and restore a device configuration. In principle, all LOYTEC devices with a built-in web server offer the backup and restore function on the web interface. Also the Configurator tools provide this function for their respective device models. When using the L-WEB System, backups of device configuration can be created on a timely basis (e.g. once a day) and restored easily when needed. Devices with SD card support and USB port allow a device backup onto external storage. In this case, the backup and restore function is operated locally on the LCD display. In all cases, the LOYTEC device is restored with all data points, dynamic NVs and bindings, BACnet server objects and client mappings, etc. The device appears again as commissioned and online and is fully functional in the network. In case an LNS-based tool is used, the LNS device needs to be replaced, which can be done at a later time.

Device Manager



LWEB-900 gives a clear overview of the status of all devices and provides detailed information for each device (e.g. device type, name, IP address, firmware version, configuration file, program file, etc.). A firmware update can be performed for individual devices or groups of devices. A backup feature ensures a regular backup of all relevant device configurations. If a defective device needs to be replaced, the configuration can be easily restored. Depending on the device hardware, the restore operation can be initiated either from the LCD UI of the device or from the LWEB-900 Client.

Device Configuration



LWEB-900 manages and configures all LOYTEC devices based on a central database. The required device configuration software can be opened directly in LWEB-900 and the configuration files are stored in the data base.

AKS – Identification Keys



Each data point is uniquely identified by its name and path. With LWEB-900, you can define your own identification key schema and assign identification keys (IK) to each data point. The IK schema can be exported and imported into other LWEB-900 projects.

SNMP



The built-in SNMP server (Simple Network Management Protocol) provides network management information of a device that can be used by customary IT tools. Via a configurable SNMP agent, status information and statistics with standard MIBs (Management Information Bases), system registers, and all OPC-exposed data points can be read and monitored, and also alarms can be sent.

Functions

Visualization / Operate and Monitor

Local Manual Operation



The LOYTEC device is equipped with a graphical LCD display (128x64) and a jog dial, which can be used for monitoring, testing, and configuration. The backlight is automatically turned off after 30 minutes of jog dial inactivity. Access to the display can be protected by a PIN code. The display can show the current device configuration and allows its modification. All basic settings (IP address, BACnet ID, etc.) can be made on the LCD display.

Apart from configuration, L-INX Automation Servers and L-GATE Gateways with a graphical LCD display allow operating trend data backup to external storage (SD card or USB stick) and backup/restore of the entire device configuration. Also the state of the integrated data points can be displayed and modified. Remote access to the LCD display over an Ethernet/IP connection is made possible by the VNC protocol.

In L-IOB I/O Modules and Controllers, the graphical LCD display allows – apart from modifying the configuration – access to physical I/O data points and parameters. The data point state is displayed as a value and engineering unit, as a status text, or showing dynamic symbols. Inputs and outputs can be switched to manual mode on the display and thus be decoupled from the physical input or the output value from the logic application.

VNC



The VNC (Virtual Network Computing) service offers password-protected remote access to the LOYTEC device. VNC employs a client-server model. The VNC server is a built-in component of the LOYTEC device. A great variety of free or commercial VNC clients is available on the market for different platforms. Which functions and views are exposed over VNC depends on the device.

Web Server for Device Configuration



The web interface on LOYTEC devices with a built-in web server provides an alternative to the Configurator tool for the maintenance personnel. It can be used to configure device and communication settings. It also provides extensive statistical information on the used communication protocols for analysis and troubleshooting. Backup and restore can also be operated on the web interface.

LOYTEC devices with an Ethernet/IP interface display data point values and states on the web interface coming from different communication networks or registers. The display contains a data point list, a tree view, and a breadcrumb navigation for fast access to subdirectories. The data point list shows the data point name, direction, type, data point state, the current value, and a description. All values are updated live. Data points can also be modified on the web interface.

On LOYTEC devices with L-WEB support, all available graphical user interfaces are listed on the web interface and can be started with a mouse click. LOYTEC devices with AST™ functions (Alarming, Scheduling, and Trending) offer access to those functions over the web interface.

An alarm summary page displays all currently active alarms of alarm data points, which can also be acknowledged, if configured so. The web interface also provides access to a historical alarm log, which lists alarms and acknowledgements. If an inactive, acknowledged alarm disappears from the alarm summary page, the last transition is stored in the alarm log. The content of the historic alarm log can be exported to a CSV file on the web interface.

The web interface provides a scheduler page, which allows modification of schedules and calendar entries for exception days during runtime. For existing local schedulers, the web interface supports the re-configuration of the scheduled data points. The changes become effective immediately and do not require a reboot of the device. For adding or removing data points to or from a scheduler, no reboot is necessary either.

The trend log configuration page on the web interface allows the reconfiguration of existing trend logs during run-time. This also includes the assignment of new data points. The changes become effective immediately and do not require a reboot of the device. The trended data can be exported into a CSV file over the web interface.

LWEB-900



The LWEB-900 Building Management System offers a BACnet Operator Workstation capability to integrate BACnet devices via BACnet/IP. In addition most LOYTEC devices can use the OPC XML-DA web service to get connected to LWEB-900. LWEB-900 is a highly flexible and scalable solution which accompanies you from installation and configuration of LOYTEC devices (L-INX Automation Servers, L-IOB I/O Modules and Controllers with IP connectivity, L-ROC Room Controllers, L-GATE Gateways, L-VIS Touch Panels, L-DALI Controllers), all the way to daily operation of the facilities.

Graphical View



Graphical views are schematics that help to visualize and operate areas of a building. Each graphical view can consist of a large number of dynamic display elements which reflect the current status of the facilities. LWEB-900 provides the graphical view within the LWEB-900 User Interface of the software and additionally offers distributed LWEB-900 clients the same functionality of visualization through web services.

LWEB-802/803 Visualization



Most LOYTEC devices can manage and store graphical projects (L-WEB projects). These projects can be created without knowledge of any web-based language within the L-VIS/L-WEB configuration tool. Customized graphical pages with dynamic content can be shown either with LWEB-803 on Windows PCs or with LWEB-802 in a standard browser.

Reporting



LWEB-900 can create reports based on trend logs. Reports can be used, for example, to document the energy consumption in a building. The generation of a report can be triggered in one of the following ways:

Periodically: Reports can be generated daily, weekly, monthly, or yearly.

Event: The change of a data point value can trigger a report.

Manually: A report can be triggered manually by the user.

Reports can be generated in PDF, Excel, or Word format. They can be automatically distributed via e-mail.

User Management



LWEB-900 provides a separate work environment for each user. A user has to log on to the system and is presented with a perspective tailored to his individual requirements. A perspective defines which windows are open and how they are arranged. In this way, a user can define separate perspectives which are optimized for different tasks and quickly switch between them.

LWEB-900 uses access control lists to define which operations a user can perform on a certain object (e.g. folder, data point, graphical view, parameter view, trend chart). To speed up the access right configuration, access control lists can be inherited from parent to child objects.

Parameter View



The LWEB-900 parameter view allows configuring operational parameters, which are distributed over multiple devices, efficiently. For example, parameters for room temperature control, light control, or sunblind control can be organized in different parameter views. Each parameter view is a matrix where each cell represents a parameter. Parameters can be organized freely in the matrix depending on space layout and function. In this way, it is possible to e.g. adjust the running periods of sunblinds across many rooms with a few mouse clicks and write the new values reliably into the corresponding automation devices.

Functions

Watch View



The LWEB-900 watch view allows observing data point values in real time. Depending on the data point types, the values can also be changed and easily edited within the watch view. You are able to see what is actually going on in the network.

Integration of Web Cams



LWEB-900 can integrate web cams supporting the ONVIF standard. The local subnet scanning feature detects cameras automatically and reduces configuration effort significantly. The live image of a camera can be added to graphical views. LWEB-900 automatically detects the capabilities of a camera and maps events (e.g. motion detection, people counter information) and commands (e.g. PTZ control) to data points. LWEB-900 does not record videos itself but can command a camera to start recording if an alarm occurs.

Multi-Site



This feature allows accessing multiple LWEB-900 Servers located at different sites with a single LWEB-900 Client. It is possible to create a common graphical view showing data from the different servers. Devices, alarms, and users can be managed across the sites. To enable this feature the LWEB-900-MS license needs to be installed on each LWEB-900 Server.

L-STAT



The L-STAT is a room operator panel with a modern, minimalistic look that fits any interior design. It is directly connected to a LOYTEC controller with a Modbus interface such as L-ROC.

L-WEB Building Management & L-STUDIO



LWEB-900



Datasheet #89016123

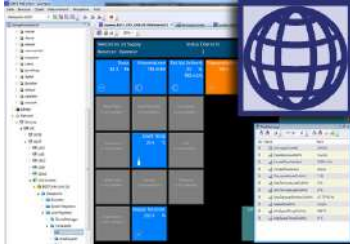

The integrated building management software LWEB-900 provides a user interface to manage and operate a LOYTEC building management system. LWEB-900 is a highly flexible and scalable solution which accompanies you from installation and configuration of LOYTEC devices (L-INX Automation Servers, L-IOB I/O Modules and Controllers with IP connectivity, L-ROC Room Controllers, L-GATE Gateways, L-PAD / L-VIS Touch Panels, L-DALI Controllers), all the way to daily operation of the facilities. Thus, a common user interface for the building automation system is available at all phases of the project.

LWEB-900 uses a client-server model consisting of the LWEB-900 Server and one or multiple LWEB-900 Clients. The LWEB-900 Server manages and stores system and operating parameters, historic data, access rights, and device configurations in an SQL data base. It exchanges real time data with distributed autonomous LOYTEC devices via web services independently of the underlying field bus technology (CEA-709, BACnet, DALI, M-Bus, Modbus, KNX, etc.).

The LWEB-900 Client is the user interface of the building management system. The client can be installed on the same PC as the server or on a remote PC. The use of web services to communicate between clients and server ensures that remote access is easily possible across firewalls and NAT routers. In this way, Intranet and Internet can be used to build distributed building automation systems. In addition, differences between the various field bus technologies are compensated and the user is presented with a consolidated view of the separate communication systems.

To check the status of the buildings technical equipment, there is no need to install the LWEB-900 Client. If you have an IP connection to the LWEB-900 Server, you can use a standard web browser to operate and monitor the building automation system. It makes no difference, whether a smart phone, tablet, or PC is used.

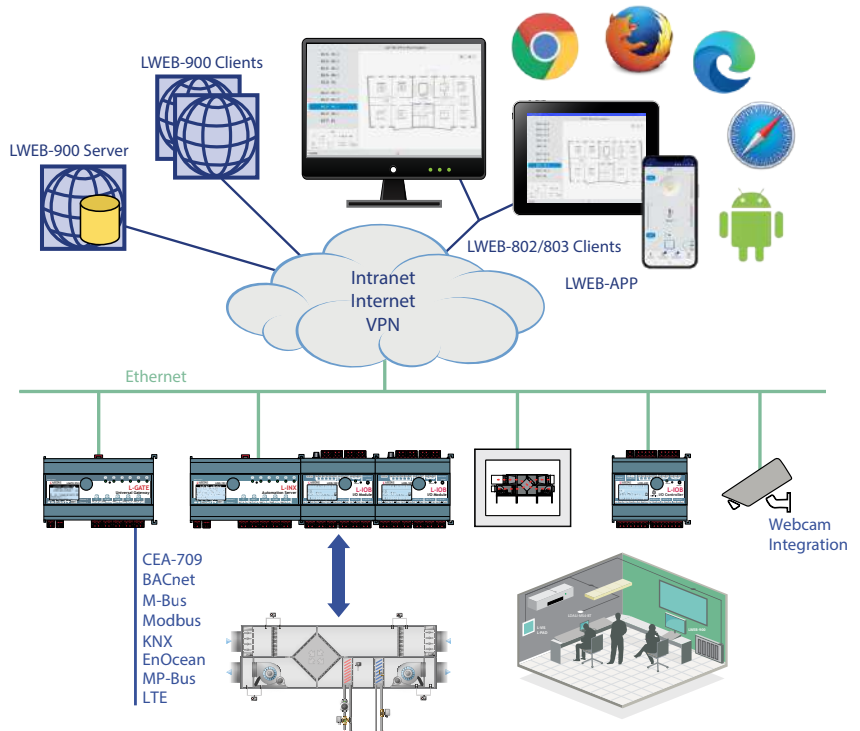
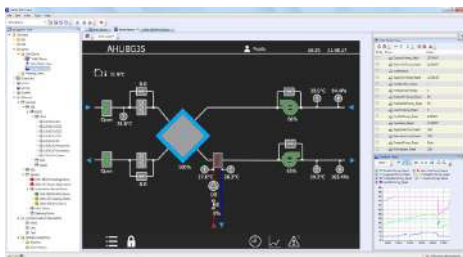



Visualize and Operate

The LWEB-900 Client adapts to the needs of the user. A large number of different views is available to represent data from the building in an intuitive way. For example, graphical views can be arranged in a perspective together with an alarm view, navigation view, and data point watch view.

To operate and monitor the building technical equipment a standard web browser can be used. In this way it is possible to quickly check the status of the building automation system while travelling. It makes no difference, whether a smart phone, tablet, or PC is used. Compared to the LWEB-900 Client, the functionality of the web application is limited to the daily operation of the building and does not include the functionality to install and configure the system.

Graphical View

In LWEB-900, all areas of a building can be visualized and operated using graphical views. Each graphical view can consist of a large number of dynamic display elements which reflect the current status of the facilities in real-time. These display elements also include complex elements like alarms, trend logs, and schedules. The configuration software to design the graphical representation of the installation is built directly into LWEB-900. Basic functions and attractive pages can be created in no time without any know-how in HTML, Java, etc. Dynamic information is shown in the form of numeric values, text, changing icons, bar graphs, trend logs, alarm and event lists, or schedule controls. Pixel graphics in all common file formats (GIF, JPG, BMP, TIFF, PNG, MNG, ICO), vector graphics (SVG) as well as alpha blending are supported.



Alarming

With LWEB-900, alarms from different sources can be visualized and managed in a uniform manner. It makes no difference whether an alarm is generated by a L-INX Automation Server to report that a V-belt is torn, by a DALI light controller to report that the emergency light test fails, or by an L-GATE device to report an alarm from a 3rd party system. In LWEB-900, these alarms are presented in a common way which enables the user to maintain an overview. The user can acknowledge or disable alarms. When an alarm occurs, one or multiple receivers can be notified via e-mail or SMS. If the alarm is not acknowledged within a configurable amount of time, an alternative action can be triggered.

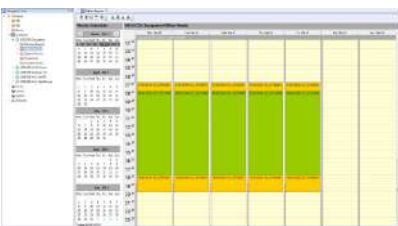

Scheduling

Schedules can either be executed in LOYTEC devices or directly in the LWEB-900 Server. To optimize the system, the scheduler should be at the same location as the corresponding control logic. For example, an occupancy scheduler should be executed by the L-INX automation controller which primarily uses this information, whereas a scheduler determining which people are notified about alarms should be executed in the LWEB-900 Server. LWEB-900 offers the unique possibility of organizing schedules executed on different devices in a hierarchical way and configuring them efficiently. The user interface is designed for non-technical users and is similar to calendar functions of common office applications. Schedulers are organized in a tree structure. Entries on the highest hierarchical level have an impact on all schedulers. Entries on a lower hierarchical level affect only the schedulers below that level. Local changes on the device are identified and can either be accepted or rejected. After the schedule hierarchy has been defined, LWEB-900 calculates the resulting configurations and if the scheduler is executed decentralized in a LOYTEC device, it downloads them to the corresponding device.

LWEB-900



Trending

LOYTEC devices can record the values of data points over time. However, the memory available on a device is limited. LWEB-900 overcomes this restriction by reading out the trend data from the devices periodically and storing everything in the database. A user can also create ad-hoc trend logs directly in LWEB-900. This is the fastest way to create a trend log. One simply selects a data point and activates trending using the context menu. LWEB-900 periodically polls the data point value from the device and stores the value in the database. If the LWEB-900 Server cannot access the LOYTEC device directly via IP, an alternative communication method is available: the device can automatically e-mail trend data to the server. Trend logs can be viewed either as tables or as charts. Especially for trend charts, a large number of customization options are available. In addition, LWEB-900 allows exporting trend data as CSV files.

Event Log

All events are logged by LWEB-900 in the database. Events include alarms, alarm acknowledgements, log-in and log-out of users, change of operational parameter, change of device configuration, system messages, etc. The event log view offers a large variety of filters to efficiently analyze all activities in LWEB-900.

Parameter View

The parameter view allows configuring operational parameters, which are distributed over multiple devices, efficiently. For example, parameters for room temperature control, light control, or sunblind control can be organized in different parameter views. Each parameter view is a matrix where each cell represents a parameter. Parameters can be organized freely in the matrix depending on space layout and function. In this way, it is possible to e.g. adjust the running periods of sunblinds across many rooms with a few mouse clicks and write the new values reliably into the corresponding automation devices. The parameter view also allows to display real-time values.

Global Connections

With LWEB-900 it is easy to connect data points of different LOYTEC devices via Ethernet/IP. For this purpose, a global connection can simply be created and drag and drop can be used to add input and output data points. It makes no difference whether the data points represent physical I/Os of L-IOB devices or data from field bus systems (CEA-709, BACnet, DALI, M-Bus, Modbus, KNX, etc.). LWEB-900 configures all devices which are part of the global connection accordingly. After the connection has been configured, the devices exchange data directly over the IP Network (without LWEB-900).

Device Manager

LWEB-900 gives a clear overview of the status of all devices and provides detailed information for each device (e.g. device type, name, IP address, firmware version, configuration file, etc.). A firmware update can be performed for individual devices or groups of devices. A backup feature ensures a regular backup of all relevant device configurations. If a defective device needs to be replaced, the configuration can be easily restored. Depending on the device hardware, the restore operation can be initiated either from the LCD UI of the device or from the LWEB-900 Client.

Device Configuration

LWEB-900 manages and configures all LOYTEC devices based on a central database. The required device configuration software can be opened directly in LWEB-900 and the configuration files are stored in the data base.

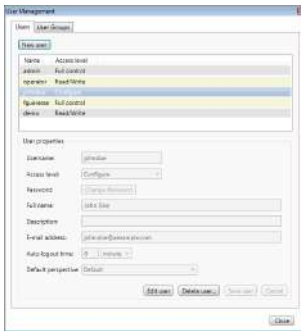

User Management

LWEB-900 provides a separate work environment for each user. A user has to log on to the system and is presented with a perspective tailored to his individual requirements. A perspective defines which windows are open and how they are arranged. In this way, a user can define separate perspectives which are optimized for different tasks and quickly switch between them.

LWEB-900 uses access control lists to define which operations a user can perform on a certain object (e.g. folder, data point, graphical view, parameter view, trend chart). To speed up the access right configuration, access control lists can be inherited from parent to child objects.

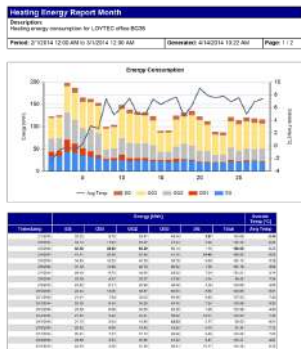

Reporting

LWEB-900 can create reports based on trend logs. Reports can be used, for example, to document the energy consumption in a building. The generation of a report can be triggered in one of the following ways:

- Periodically: Reports can be generated daily, weekly, monthly, or yearly.
- Event: The change of a data point value can trigger a report.
- Manually: A report can be triggered manually by the user.

Reports can be generated in PDF, Excel, or Word format. They can be automatically distributed via e-mail.

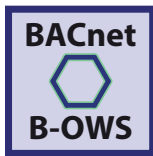

BACnet Operator Workstation B-OWS

A BACnet Operator Workstation is designed to provide an operator with all the information and editing ability needed for managing a system on a daily basis. In addition to viewing and editing selected BACnet object, an Operator Workstation can display trends, schedules, and other specialized objects. It can also display reports and graphics. A BACnet Operator Workstation will notify the operator that an alarm has occurred, lets the operator acknowledge the alarm, provides a summary of alarms, and allows to adjust the alarm thresholds of analog objects.



Watch View

The watch view allows observing data point values in real time. Depending on the data point types, the values can also be changed and easily edited within the watch view. You are able to see what is actually going on in the network.



AKS – Identification Keys

Each data point is uniquely identified by its name and path. With LWEB-900, you can define your own identification key schema and assign identification keys (IK) to each data point. The IK schema can be exported and imported into other LWEB-900 projects.



Integration of Web Cams

LWEB-900 can integrate web cams supporting the ONVIF standard. The local subnet scanning feature detects cameras automatically and reduces configuration effort significantly. The live image of a camera can be added to graphical views. LWEB-900 automatically detects the capabilities of a camera and maps events (e.g. motion detection, people counter information) and commands (e.g. PTZ control) to data points. LWEB-900 does not record videos itself but can command a camera to start recording if an alarm occurs.



Multi-Site

This feature allows accessing multiple LWEB-900 Servers located at different sites with a single LWEB-900 Client. It is possible to create a common graphical view showing data from the different servers. Devices, alarms, and users can be managed across the sites. To enable this feature the LWEB-900-MS license needs to be installed on each LWEB-900 Server.

Integrated Building Management System

LWEB-900

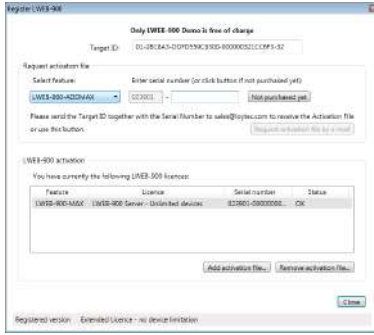

Licensing

The licensing is based on the number of devices connected to an LWEB-900 Server. The base license includes 10 LOYTEC device licenses. To extend the number of devices, add-on licenses for 10 devices are available. An add-on license for an unlimited number of devices is available as well. For customers who know right from the beginning that they need a license for an unlimited number of devices, such license is offered as well. The maximum number of devices that can be integrated on an LWEB-900 Server depends on the PC and the database resources provided. LOYTEC L-IP Router and L-IOB Modules connected to L-INX Automation Servers do not consume a device license. A LWEB-900 demo license with 30 days runtime is provided, including 10 device licenses.

The license also restricts the maximum number of concurrent LWEB-900 Clients and LWEB-802/803 Clients (access for end user via web browser or Windows application) and LWEB-APP Clients (access for end user via LOYTEC Android app or LOYTEC iOS/iPadOS app). The standard license includes 5 LWEB-900 Clients and 20 LWEB-802/LWEB-803/LWEB-APP Clients.

The VPN feature requires two licenses: The VPN base license enables the VPN function. Each active LWEB-900 project for which VPN is enabled requires a separate VPN base license license. The VPN maintenance license is required to add devices to the VPN using the VPN web services. The VPN maintenance license is valid for all projects on the server but is limited to the duration of one year. The VPN will continue to operate after the VPN maintenance license has expired.

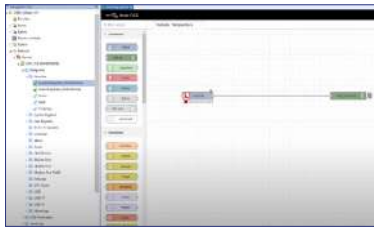

Scripting

The functionality of the LWEB-900 Server can be extended with custom Node.js scripts. This feature allows connecting the system to almost any cloud service, either for uploading historical data to analytics services, delivering alarm messages to alarm processing services or operating parts of the control system over a cloud service (e.g., scheduling based on Web calendars or booking systems). Processing Internet information such as weather data in forecast-based control is also possible. Finally, the JavaScript kernel also allows implementing serial protocols to non-standard equipment in primary plant control.

LWEB-900 also integrates the Node-RED™ run-time. Node-RED™ is a flow-based development tool for visual programming.



VPN

LWEB-900 provides very quick and easy configuration of a virtual private network (VPN) consisting of LOYTEC devices, LWEB-900 clients and any other devices supporting the OpenVPN protocol. Each LOYTEC device establishes a VPN tunnel

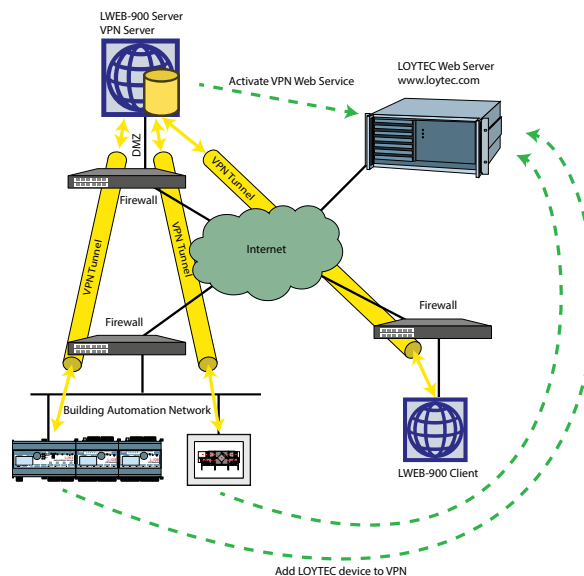

to the VPN server configured by LWEB-900. PCs running the LWEB-900 client or mobile devices can join to the VPN to have direct access to LOYTEC devices. It is possible to create multiple projects in one LWEB-900 Server. For each project, the VPN function can be enabled separately creating distinct VPN instances.

Conclusion

Together with LOYTEC devices, LWEB-900 is a seamless and comprehensive solution for building automation. Instead of separate tools and project files for different devices, LWEB-900 provides a common user interface for configuring and operating the complete system. The consistent use of web services for data communication allows controlling LWEB-900 from remote, no matter whether there are firewalls and NAT routers or not. In this way, end users and service technicians can monitor, operate, and configure the buildings’ technical equipment from remote using standard IP technology.

Features

- Displays customized graphical pages with dynamic content
- Multi-browser support (web access)
- Alarming from different sources, and time- and event-based forwarding via e-mail to several recipients
- Hierarchical organization of calendar and scheduler parameters across multiple devices and within the LWEB-900 Server
- Presentation of trend data in the form of charts or tables
- Structured representation and efficient adaptation of system and operating parameters (Parameter View)
- Fast and system-wide access to real time data
- Supports Global Connections
- SQL data base server
- Manages multiple users and access rights via ACL
- Reporting module to generate reports from trend logs using templates
- Configuration software for LOYTEC hardware can be directly started within the LWEB-900 user interface
- Automatic, periodic device backup and easy recovery of the device configuration for a device replacement
- Checks if firmware updates are available (Internet connection required) and displays devices with outdated firmware
- Download of the latest firmware for a defined group of devices
- Uses web services for communication (OPC XML-DA, SOAP/XML)
- Easy communication across firewalls and NAT routers on the Intranet and Internet
- Import/Export of trend logs and identification keys schema
- BACnet Operator Workstation (B-OWS)
- Watch View allows observing data points in real time
- Integration of Web cams
- Multi-site support
- VPN support
- Scripting

Specifications

Compatible with	L-INX Automation Server, L-ROC Room Controller, L-GATE Gateway, L-DALI Controller, L-VIS / L-PAD Touch Panels, L-IOB I/O Controller, L-IP Router
Operating system	Windows 10, Windows 11, Windows Server 2012, Windows Server 2016, Windows Server 2019, Windows Server 2022
Hardware requirements	LWEB-900 server: PC with at least 2 GHz, 32- or 64-bit processor, 4 GB RAM, 50 GB free hard disk space, Ethernet connection LWEB-900 client: PC with at least 2 GHz, 32- or 64-bit processor, 2 GB RAM, 1 GB free hard disk space, Ethernet connection, screen resolution 1280x720

Resource Limits

Recommended limit for SQLite	10 GBytes, 1 record =100 bytes -> 100.000.000 records
Max. number of devices	1000
Max. number of multi-sites	50

Integrated Building Management System

LWEB-900

Order number	Product description
LWEB-900	Building Management Software for 10 devices (L-IP Router and L-IOB I/O Modules connected as extension to the L-INX Automation Servers, L-ROC Room Controllers and L-IOB I/O Controllers do not consume a device license), licenses for 5 LWEB-900 Clients and 20 LWEB-80x Clients are included
LWEB-900-ADD-10	Add-on license for 10 additional devices
LWEB-900-ADD-MAX	Add-on license for max. 1000 devices
LWEB-900-MAX	Building Management Software for an unlimited number of devices, licenses for 5 LWEB-900 Clients and 20 LWEB-80x Clients are included
LWEB-900-CL-5	Add-on license for additional 5 LWEB-900 Clients
LWEB-900-80x-50	Add-on license for additional 50 LWEB-80x Clients
LWEB-900-80x-100	Add-on license for additional 100 LWEB-80x Clients
LWEB-900-80x-MAX	Add-on license for an unlimited number of LWEB-80x Clients
LWEB-900-MS	Add-on license to enable multi-site support
LWEB-900-VPN-BASE	Add-on license to enable VPN support in LWEB-900 for one project, includes LWEB-900-VPN-MNT for 1 year
LWEB-900-VPN-MNT	Add-on license to add/remove VPN clients in LWEB-900 for all projects. Valid for 1 year

Datasheet #89025523

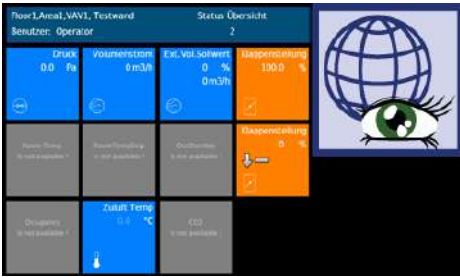

LWEB-803 is a graphical user interface to visualize dynamic pages showing plant details or a virtual room operator panel on a Microsoft Windows PC.

Dynamic Graphical Pages

The graphical pages consist of multiple dynamic graphical controls that show the current plant status in real time. It is also possible to access decentralized schedules, alarm servers, and trends. The graphical projects are designed with the L-VIS/L-WEB configuration tool free of charge. Without any know-how in HTML or Java, user specific graphical pages can be created. Dynamic information is shown through value or text controls, changing symbols, bar charts, trend views, alarm and event lists, and schedule controls. The L-VIS/L-WEB configuration tool allows for using most of the pixel graphic formats (GIF, JPG, BMP, TIF, PNG) or vector graphics (SVG). The graphical projects may be stored on a LOYTEC device connected to the building network, on a file server, or on a 3rd party web server.

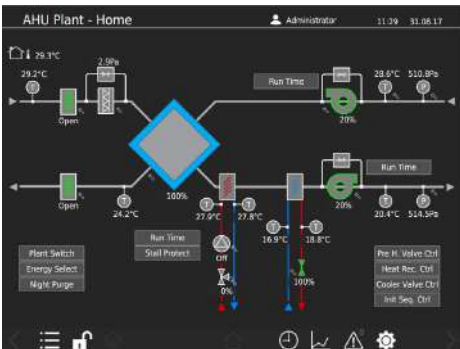

Data Point Communication through Web Services

LWEB-803 talks to LOYTEC devices using web services. Utilizing web services allows for smooth communication across firewalls and NAT routers. This way, the Intranet or Internet can be used to build up a distributed building automation system.

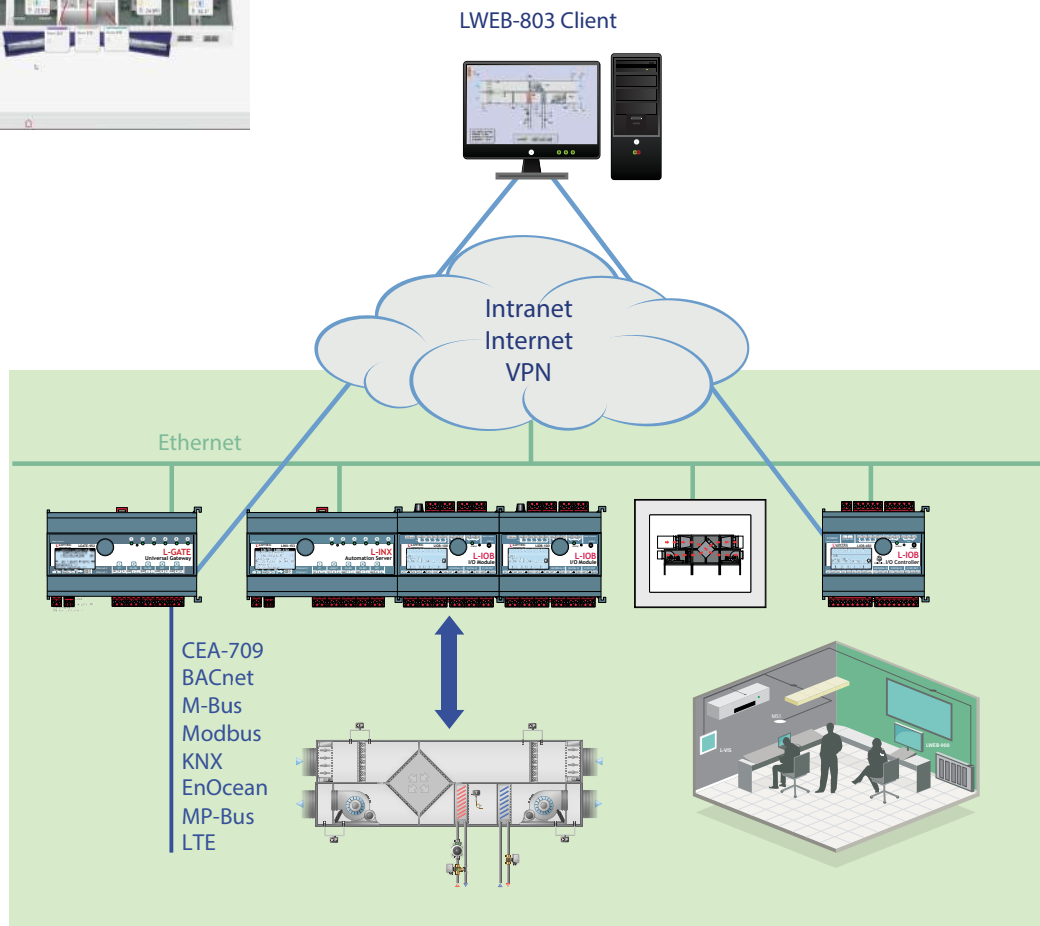
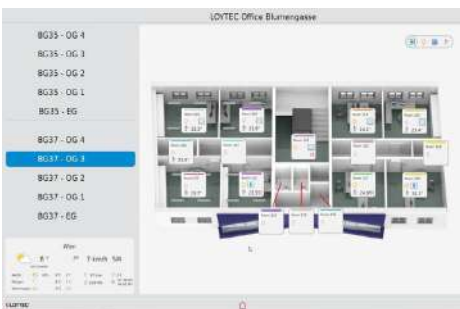

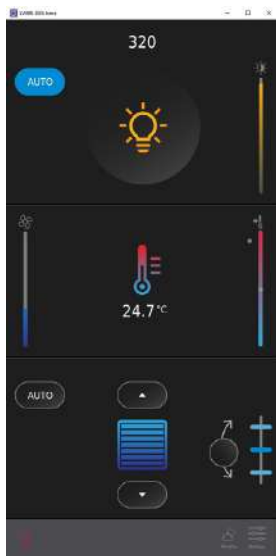

Fast Navigation

When executing the graphical project, LWEB-803 loads the complete content and stores it on a PC. When changes in the graphical project are made, reloading the project simply updates the version on the PC. During normal operation, the data communication between LWEB-803 and the LOYTEC devices is limited to data point updates. The result is a fast navigation between the pages even when the connection is slow.

Virtual Room Operator Panel on PC

LWEB-803 can be used as a state of the art alternative to physically mounted room operator panels. LWEB-803 pages can be viewed in “Design Mode” which allows showing the graphical pages without frames and with a transparent background. LWEB-803 virtual room operator panels can be stored on the LOYTEC devices and operated within the MS Windows PC environment. There is practically no limit for the designer regarding the size, colors, and utilization of graphical elements. Even high availability of the system can be achieved by storing the virtual operator panels distributed on devices in the network.

Protected Kiosk Mode

In “Kiosk Mode”, users can exclusively operate the LWEB-803 application on the PC. When in Kiosk Mode, the user has no access to the PC’s desktop or any other software running on the PC.

Show Data Points from Multiple Devices in One Page

LWEB-803 can show data points located on multiple distributed devices in one page. This functionality is particularly important when utilized in energy monitoring applications where meter values are provided by distributed LOYTEC devices. When projects are distributed across multiple devices, LWEB-803 allows to create links between the projects for a continuous operation.

Display Diversity

LOYTEC devices can host multiple LWEB-803 projects. Each of these projects can have any resolution to display them perfectly on a PC monitor. Multiple Windows PCs can access LOYTEC devices at the same time. Widgets or dashboards can be created and placed on the PC desktop. Virtual room units can be designed appealingly in terms of style and usability to give access to room functions.

Features

- Displays customized graphic pages with dynamic content
- User-specific page layout, optionally frameless with transparent background
- Support of vector fonts
- Allows access to automation functions such as Alarming, Scheduling, and Trending (AST™)
- Presentation of trend data in the form of charts or tables
- Display of alarms in alarm lists
- Allows links between distributed LWEB-803 projects for a continuous operation
- Design of graphical projects with the L-VIS Configuration software
- Automatic updates (Internet connection required)
- Uses web services (OPC XML-DA, SOAP/XML) for communication
- Easy communication across firewalls and NAT routers

Specifications

Compatible with	L-INX Automation Server, L-ROC Room Controller, L-GATE Universal Gateway, L-VIS Touch Panel, L-IOB I/O Controller, L-DALI Controller
Operating system	Windows 10, Windows 11, Windows Server 2016, Windows Server 2019, Windows Server 2022
Configuration tools	L-INX Configurator and L-VIS/L-WEB Configurator

Order number	Product description
LWEB-803	Graphical user interface, visualization on Windows PC, free download

Datasheet #89025722

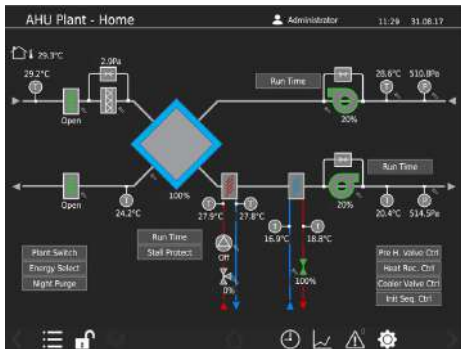

LWEB-802 is a platform independent graphical user interface to visualize dynamic pages showing plant details or a virtual room operator panel in a standard web browser. By utilizing HTML5 and Java Script, the pages can be shown in a standard web browser without the need to install any additional software or browser plug-ins. LWEB-802 is tested to work with PCs (MS and MAC), smart phones, and tablets running Android OS or iOS. No apps are required or need to be maintained. The page creation process and also the feature set is the same as for LWEB-803.

Dynamic Graphical Pages

The graphical pages consist of multiple dynamic graphical controls that show the current plant status in real time. It is also possible to access decentral schedules, alarm servers, and trends. The graphical projects are designed with the L-VIS/L-WEB configuration tool free of charge. Without any know-how in HTML or Java, user specific graphical pages can be created. Dynamic information is shown through value or text controls, changing symbols, bar charts, trend views, alarm and event lists, and schedule controls. The L-VIS/L-WEB configuration tool allows for using most of the pixel graphic formats (GIF, JPG, BMP, TIF, PNG) or vector graphics (SVG). The graphical projects may be stored on a LOYTEC device connected to the building network, on a file server, or on a 3rd party web server.

Data Point Communication through Web Services

LWEB-802 talks to LOYTEC devices using web services. Utilizing web services allows for smooth communication across firewalls and NAT routers. This way, the Intranet or Internet can be used to build up a distributed building automation system.

Fast Navigation

When opening the project, the complete content is loaded into the web browser. Navigating through the pages is done without loading any more content. The communication between LWEB-802 and LOYTEC devices is reduced to just data point updates. The result is extremely fast navigation between graphical pages even when the connection is slow.

Room Operation through Web Browser

Specifically for room automation applications, LWEB-802 can be used as a state of the art alternative to room operator panels. Virtual room operator panels can be stored on the LOYTEC devices and operated within a standard web browser. There is practically no limit for the designer regarding the size, colors, and utilization of graphical elements. A high availability of the system can be achieved by storing the virtual operator panels distributed on devices in the network.

Show Data Points from Multiple Devices in One Page

LWEB-802 can show data points located on multiple distributed devices in one page. This functionality is particularly important when utilized in energy monitoring applications, where meter values are provided by distributed LOYTEC devices.

Graphical User Interface

LWEB-802

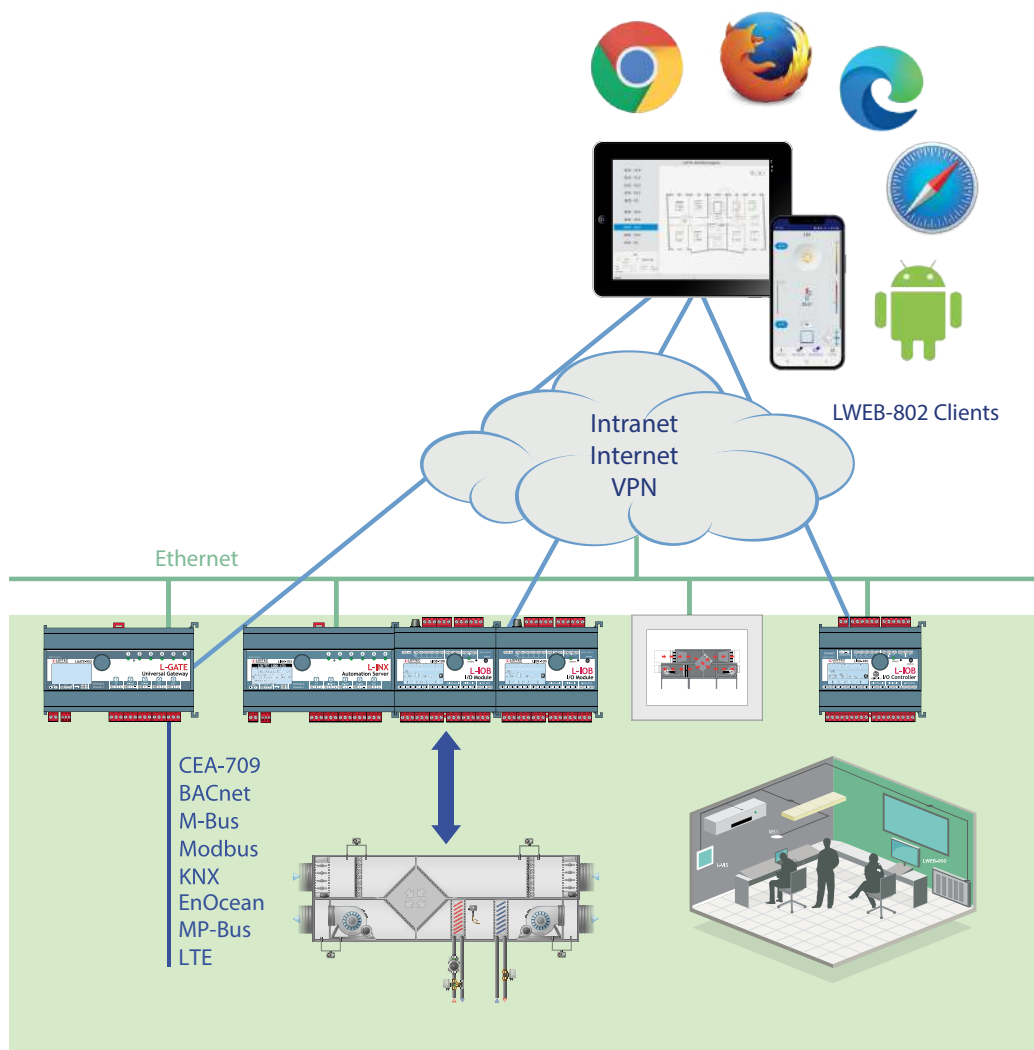

Features

- Displays customized graphic pages in the web browser
- Multi-browser support
- Allows access to automation functions such as Alarming, Scheduling, and Trending (AST™)
- Presentation of trend data in the form of charts or tables
- Support of vector fonts
- Display of alarms in alarm lists
- Allows links between distributed LWEB-802 projects for a continuous operation
- Design of graphical projects with the L-VIS Configuration software
- Automatic updates (Internet connection required)
- Uses web services (OPC XML-DA, SOAP/XML) for communication
- Easy communication across firewalls and NAT routers

Specifications

Compatible with	L-INX Automation Server, L-ROC Room Controller, L-GATE Universal Gateway, L-VIS Touch Panel, L-IOB I/O Controller, L-DALI Controller
Web browser	Google Chrome, Firefox, Android Browser, iOS Browser, Edge
Configuration tools	L-INX Configurator and L-VIS/L-WEB Configurator

Order number Product description

LWEB-802	Graphical user interface via web browser, compatible to Android and iOS, free download
----------	--

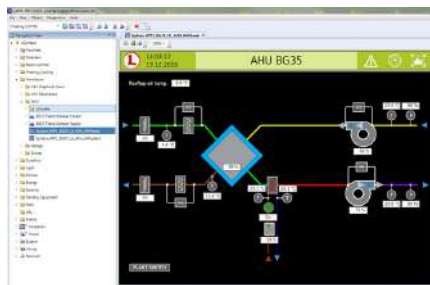
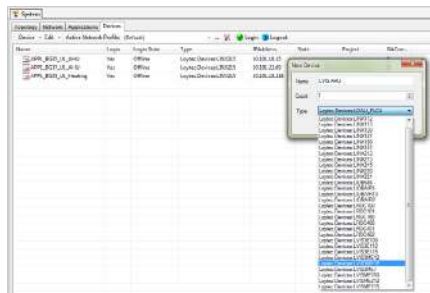
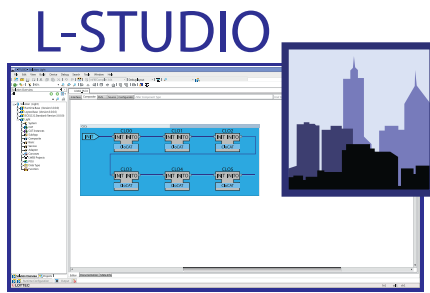

L-STUDIO 3

L-STUDIO is the ultimate development and integration platform for programmable LOYTEC controllers, such as the L-INX automation servers, L-ROC room control system or programmable visualization solutions such as the LPAD-7. It combines the major building automation disciplines -programming, communication, and visualization - into a single tool. Together with the LWEB-900 building management system, it covers all phases of building automation, from prototyping to programming, configuration, and maintenance.

Achieving the highest levels of energy-efficiency and room comfort is only possible by forging all conventional controls into a single integrated building automation application. L-STUDIO helps to develop these applications in a timely and cost-effective manner. Template-based prototyping, reusable libraries and integrated testing tools support the project engineer's efforts.

Programming

L-STUDIO speaks your language, ranging from the industry-proven PLC language IEC 61131 and its event-based successor IEC 61499 up to modern IoT applications using Node.js and Node-RED.

Using the cycle-based IEC 61131 language, classic applications such as boiler plants, air handling units or heating/cooling circuits can be easily automated. The LOYTEC building automation library already contains many sample applications that can be used as starting point for your application.

Room control applications can be implemented using the LOYTEC L-ROC room automation library. It provides an integrated solution for HVAC, lighting, and sunblinds solution as well as many other functions required in the modern living space. The room automation library uses the IEC 61499 event-based language to create low-latency and fully networked applications that eliminate the need for classical network integration.

Communication

In L-STUDIO logic blocks, called CATs, can contain technology objects, such as BACnet objects or OPC tags as templates. Data points are then automatically created when a CAT is instantiated on a device. This makes the creating of network interfaces of different technologies almost automatic. A CAT can also contain technology level objects, such as alarms, schedules or trends which are also automatically instantiated and linked to the logic program. The L-STUDIO CATs support all LINX automation server technologies: BACnet, OPC XML/DA, Bluetooth, DALI, EnOcean, SMI, CEA-709, KNX, Modbus, M-Bus and will support future technologies yet to come.

State-of-the-art buildings require Internet of Things services, such as public transport information, office booking systems or building information systems. These can be integrated using Node.JS or Node-RED. Their integration allows classical PLC programming to be combined with latest web technologies.

Visualization

L-STUDIO CATs can also contain graphical symbols. These visualize the data points of the CAT and represent the logic object in a graphical way, such as a pump diagram, a room overview, or an entire plant display.

These symbols can be combined into graphical projects that can be used on L-VIS or L-PAD devices. The graphical projects can also be used on a PC with LWEB-802/803 or on mobile devices using the LWEB-APP. All visualizations are fully editable by the user and support all features of the L-VIS technology.

Management

L-STUDIO projects can be imported into LWEB-900. All devices and graphical views are imported automatically. The parameter views of LWEB-900 allow to configure

and optimize the devices that have been created by L-STUDIO. The graphical views can be used in LWEB-900 together with the access control functions to provide the building maintainers and end-users with a secure and consistent interface to the building.

L-STUDIO provides documentation and versioning features to keep track of the project. All library blocks can be documented in HTML-style. Libraries can also be versioned, distributed in binary form or managed in a source versioning tool to track and document changes.

Supported programmable controllers

Controller	Programmable with L-STUDIO (IEC 61499)	Programmable with L-STUDIO (IEC 61131-3)
LINX-153, LINX-154	■	■
LINX-215	■	■
LROC-400, LROC-401, LROC-402, LROC-102	■	-
LIOB-585, LIOB-586, LIOB-587, LIOB-588, LIOB-589	■	■
LIOB-590, LIOB-591, LIOB-592, LIOB-593, LIOB-594, LIOB-595, LIOB-596	■	■
LDALI-PLC2, LDALI-PLC4	■	■
LPAD7-31G2, LPAD7-31G3, LPAD7-41G2, LPAD7-41G3	■	■

Supported configurable devices

Device
LDALI-3E101-U, LDALI-3E102-U, LDALI-3E104-U
LDALI-ME201-U, LDALI-ME202-U, LDALI-ME204-U
LGATE-902, LGATE-952
LINX-102, LINX-103, LINX-202, LINX-203
LPAD7-30G2, LPAD7-30G3
LVIS-3ME7-G1, LVIS-3ME7-G2
LVIS-3ME12-A1, LVIS-3ME15-A1
LVIS-3ME15-G1, LVIS-3ME15-G2, LVIS-3ME15-G3

L-ROC Room Automation



L-ROC Room Controller

L-ROC Overview

The L-ROC Room Controller is the core of the revolutionary IP based room automation system that allows for changing room layouts within seconds. L-ROC smoothly integrates in native BACnet/IP Networks and LonMark Systems at the controller level.

The L-STUDIO software allows for the creation and adjustment of flexible room applications incorporating HVAC, lighting, sunblinds and security functions into totally integrated automation systems with very little effort.

An integral part of the L-ROC solution is a web-based room operation from PCs or mobile devices (iOS and Android) via LWEB-803 dashboards (virtual room unit on PC desktop), or LWEB-802 HTML5 pages with the automatic generation of graphic projects for local room operation on L-VIS Touch Panels.

The L-ROC Room Controller family of products integrates DALI-2, KNX, LON, BACnet, MS/TP, Modbus, SMI, M-Bus, MP-Bus, and EnOcean subsystems at controller level. These integration capabilities are the foundation for outstanding scalability and flexibility.

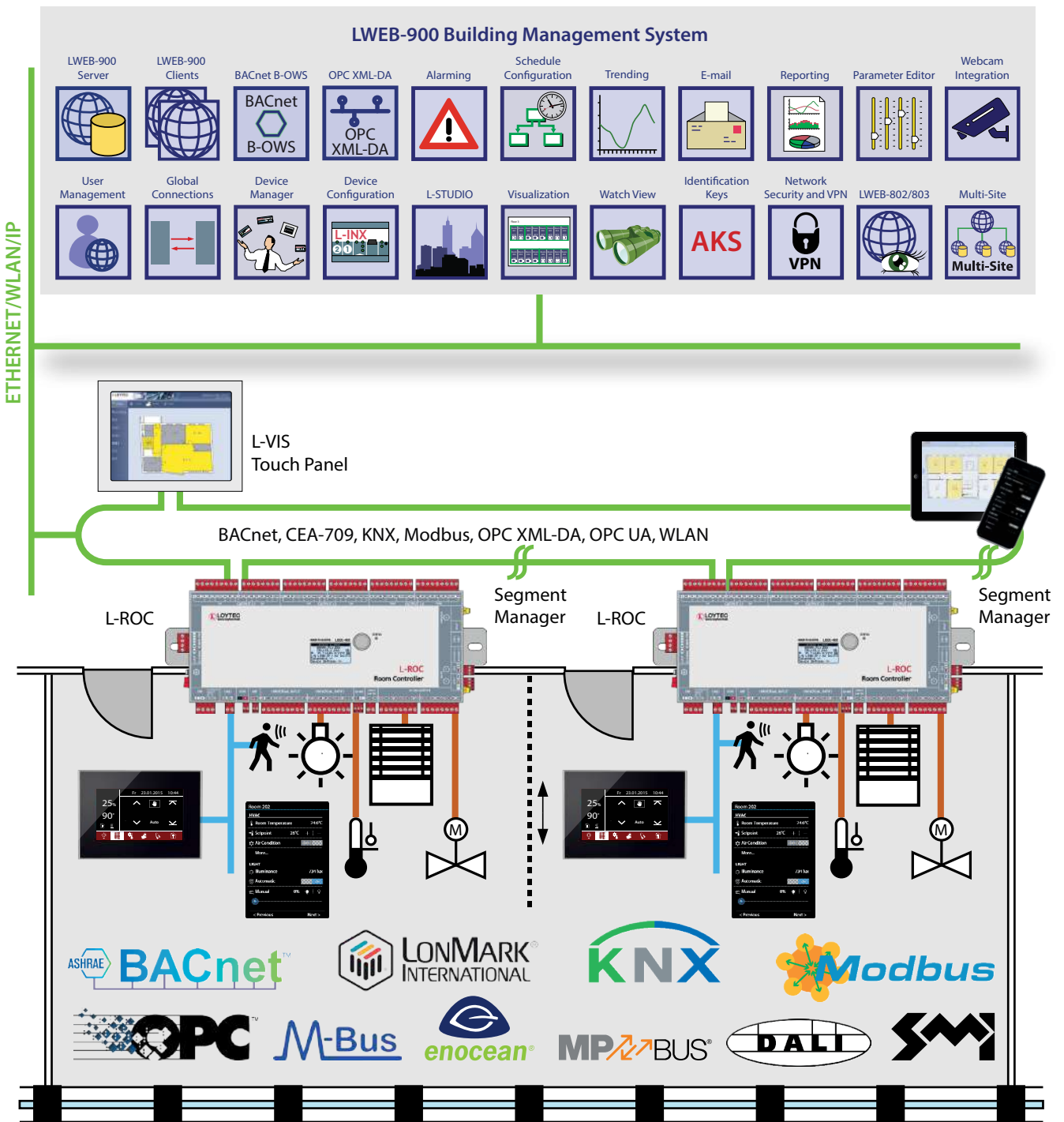

- ✓ BACnet
- ✓ CEA-709
- ✓ KNX
- ✓ Modbus
- ✓ M-Bus
- ✓ OPC



Datasheet #89026123



The L-ROC Room Controller LROC-102 provides the basis for a revolutionary room automation system based on IP, which seamlessly integrates with native BACnet/IP networks and LonMark Systems at the controller level. Together with the L-STUDIO software, flexible room solutions can be created with little effort and changed on demand. Integral parts of the L-ROC System are a web-based room operation via an LWEB-802/803 dashboard and the automatic generation of graphics for the L-VIS Touch Panel for local operation. For CEA-709 room control units, CEA-709 multi-sensors and other CEA-709 devices can be connected via the LonMark TP/FT-10 channel on the L-ROC Controller. Local inputs and outputs are provided via L-IOB I/O Modules. KNX S-mode devices can be connected through KNX TP1 by using the optional LKNX-300 module.

Flexible Room Concept for Room Automation

A room segment is the base unit of configuration in the L-ROC System. The L-ROC Library provides a set of functions for every window axis including:

- Lighting control with constant light controller
- Sunblind control with angle adjustment and year shade progression
- Temperature control for heating, cooling, and ventilation
- Occupancy detection
- Window monitoring

Each L-ROC Room Controller can handle up to 16 room segments. Based on the various room segment types, larger buildings can be modeled in a hierarchical manner. Areas are built with an area manager by combining multiple room controllers. A floor manager manages multiple areas in one floor. Depending on the architecture, the building can be split up into areas and floors as needed.

Area/Floor Managers are responsible for handling functions needed for corridor, staircase, and bathroom lighting, or even ventilation. Floor managers facilitate the data communication between the floors and handle floor relevant functions.

Rooms can now be created arbitrarily in any size by moving, installing, or removing partition walls. The resulting logical connections between the L-ROC Room Controllers will be built automatically. All graphical user interfaces and network connections are automatically generated and adapted respectively.

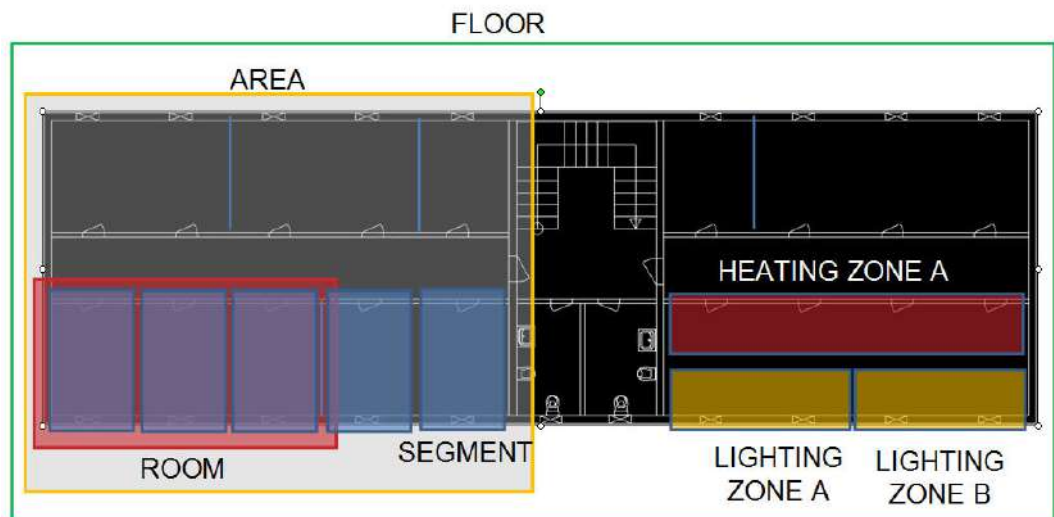
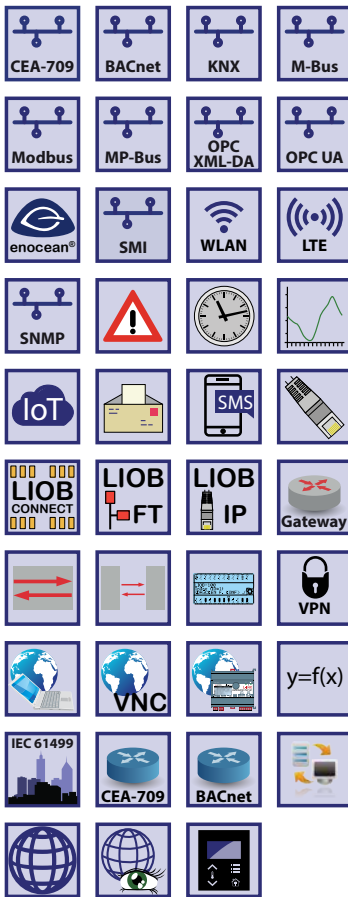

Functions
 L-WEB, L-STUDIO
 L-ROC
 L-INX
 L-IOB
 Gateways
 L-PAD-7, L-VIS, L-STAT
 L-DALI
 Routers, NIC
 Interfaces
 Accessories

LROC-102



AST™ for every Room Segment

L-ROC provides a set of functions for Alarming, Scheduling, and Trending (AST™) for every room segment. Each room segment can be operated entirely independently. The AST™ functions are fully available to higher-level systems through BACnet/IP and web services (L-WEB System). Distributed schedulers can be efficiently managed and changed with LWEB-900.

Room Communication through redundant or separated IP Network

L-ROC Room Controllers are interconnected via a 100Base-T Ethernet network. Each L-ROC device is equipped with two Ethernet ports. It can either be configured to use the internal switch to interconnect the two ports or every port is configured to work in a separate IP network.

When the Ethernet ports are configured for two separate IP networks, one port can be connected for instance to a WAN (Wide Area Network) with enabled network security (HTTPS) while the second port can be configured to be connected to an insecure network (LAN) where the standard building automation protocols like BACnet/IP, LON/IP, or Modbus TCP are present. These devices also feature firewall functionality of course to isolate particular protocols or services between the ports. The built-in VPN function provides for simple VPN setup and secure access to remote sites. The LTE-800 interface enables wireless access to remote sites through a mobile carrier.

Using the internal switch, a daisy chained line topology of up to 20 devices can be built, which reduces costs for network installation. The IP switch also allows the setup of a redundant Ethernet installation (ring topology), which increases reliability. The redundant Ethernet topology is enabled by the Rapid Spanning Tree Protocol (RSTP), which is supported by most managed switches.

Integrated L-WEB Room Operation

L-ROC controllers provide graphical user interfaces for room operation directly via an IP connection to the user, without the need for an additional web server. Graphic projects are distributed among the L-ROC Room Controllers and can be accessed by LWEB-802/803 from any PC workstation, smart phone, or tablet PC running Android or iOS.

Integration of the L-STAT Room Operator Panel

Per L-ROC Room Controller up to 16 L-STAT room control devices can be integrated into building automation via Modbus RTU (RS-485) interface. In addition to the attractive, modern design and intuitive operation, L-STAT provides a range of other features to individually increase the room comfort.

Internal sensors measure temperature, humidity, condensation, occupancy, and also the CO₂ value of the air. There is also the possibility to control room functions via an IR remote control. Standard pushbuttons and external temperature sensors can be integrated through additional inputs.

Connection to Higher-Level Systems

Higher-level systems can seamlessly integrate L-ROC Room Controllers via BACnet/IP, BACnet/SC, LonMark IP-852, or web services (OPC).

All these protocols are simultaneously available. It is possible to integrate the L-ROC Room Controller in a BACnet Operator Workstation and at the same time L-ROC will communicate with other CEA-709 devices on the IP-852 channel. Moreover, a higher-level SCADA or ERP System (Facility Management) gets information directly from the L-ROC Room Controller by using web services based on OPC.

Full LWEB-900 Support

The L-WEB System uses web services to communicate with the L-ROC System. All device and operating parameters of every single L-ROC Room Controller are

automatically synchronized with the LWEB-900 SQL database by the LWEB-900 client or the LWEB-900 Master Device Manager. The parameters are available to all L-WEB client applications.

I/O Integration via Plug and Play

The L-ROC Room Controllers can automatically integrate physical I/Os by using L-IOB I/O Modules. Up to 24 L-IOB I/O Modules can be connected through LIOB-Connect, LIOB-FT, or LIOB-IP. All I/Os can be used by the L-ROC application and are also available via the web interface of L-ROC. All configurations of the L-IOB Modules are stored on the L-ROC and loaded on demand into the L-IOB I/O Modules. Exchanging I/O modules is done without any configuration effort requiring only a few quick configuration steps.



L-STUDIO

L-STUDIO is the world's first IEC 61499 based room automation system. Any room function can be realized with L-STUDIO in a distributed system of L-ROC devices. We call this new approach in automation "Cloud Control". In a cloud of L-ROC devices, all automation functions are mapped automatically to physical hardware. The object-oriented design method allows the efficient reuse of previously implemented functions. In the graphical development environment of L-STUDIO, areas are created from room segment with just a few mouse clicks. The areas are interconnected to floors and multiple floors form a building. The entire building application is automatically distributed to the L-ROC Controllers installed in the building.

New functions can be added to the room segment objects after initial configuration. These new functions can be applied individually or to all room segment objects very easily. Comprehensive debugging and watch functions allow for complete building troubleshooting. An extensive library of functions is provided for heating, ventilation, cooling, lighting, sunblind control, and security. With the integrated L-VIS/L-WEB Configurator, graphical pages for L-VIS Touch Panels and L-WEB applications can be customized.



Year Shade Progression

Especially in dense city areas, buildings can cast shadows on each other. In case a façade element is shaded by another building, sunblinds can be deactivated for better daylight harvesting. The high-performance L-ROC controllers allow to calculate a 3D model in dxf-Format of the building and its close-by neighbors. The model can be constructed using common 3D CAD software or can be derived from a Building Information Model. In case the scenery changes due to new constructions, only the new buildings have to be inserted in the model. The calculation can be done for each window individually or per shadowing zone.



IoT Integration

The IoT function (Node.js) allows connecting the system to almost any cloud service, either for uploading historical data to analytics services, telemetry using MQTT, delivering alarm messages to alarm processing services or operating parts of the control system over a cloud service (e.g., scheduling based on Web calendars or booking systems). Processing Internet information such as weather data in forecast-based control is also possible. Finally, the JavaScript kernel also allows implementing serial protocols to non-standard equipment in primary plant control.

L-ROC Room Controller

LROC-102

Features

- Flexible built-in management for room segments
- Room controller for up to 16 room segments
- Networking via redundant or separated IP network
- Programmable with L-STUDIO (IEC 61499)
- Extension with physical inputs and outputs using L-IOB I/O Modules (LIOB-10x/11x, LIOB-15x, and LIOB-45x/55x)
- 128x64 graphic display with backlight
- Local display of device and data point information
- Manual operation using the jog dial or VNC Client
- Integrated AST™ functions (Alarming, Scheduling, and Trending) for each room segment
- Node.js support for easy IoT integration (e.g. Google calendar, MQTT, Alexa & friends, multimedia equipment,...)
- Event-driven e-mail notification
- Math objects to execute mathematical operations on data points
- Stores customized graphical pages
- Visualization of customized graphical pages through LWEB-900 (Building Management), LWEB-803 (Monitoring and Control), or LWEB-802 (Web Browser)
- Support of the L-STAT Room Operator Panel
- Built-in OPC XML-DA and OPC UA server
- Dual Ethernet/IP interface
- Access to network statistics
- Compliant with ANSI/ASHRAE 135-2012 and ISO 16484-5:2012 standard
- Supports BACnet/IP, BACnet/SC or BACnet MS/TP
- BACnet Client Function (Write Property, Read Property, COV Subscription)
- BACnet Client Configuration with configuration tool (scan and EDE import)
- BACnet/IP compliant with B-BC (BACnet Building Controller) functionality
- Compliant with CEA-709, CEA-852, and ISO/IEC 14908 Standard (LonMark System)
- Connection of any CEA-709 device via TP/FT-10 channel
- CEA-709 integration via LonMark IP-852 (Ethernet/IP) channel
- Support of dynamically created or static NVs
- Support of user-defined NVs (UNVTs) and Configuration Properties (SCPTs, UCPTs)
- Integrated BACnet/IP to BACnet/SC and BACnet MS/TP Router including BBMD as well as Slave-Proxy functionality
- Integrated IP-852 to TP/FT-10 Router
- Connection to KNXnet/IP directly, KNX TP1 via LKNX-300 Interface
- M-Bus Master according to EN 13757-3, connection via optional M-Bus Converter (L-MBUS20 or L-MBUS80)
- Gateway functions including Smart Auto-Connect™
- Modbus TCP and Modbus RTU/ASCII (Master or Slave)
- Integrated web server for device configuration and monitoring data points
- Configurable via Ethernet/IP
- Connection to EnOcean wireless devices via LENO-80x Interface
- Supports WLAN through LWLAN-800 Interface
- Supports MP-Bus through LMPBUS-804 Interface
- Supports SMI (Standard Motor Interface) through LSMI-80x
- Supports LTE through LTE-800 Interface
- Supports RS-232 through LRS232-802 Interface
- Stores user-defined project documentation

General Specifications

Dimensions (mm)	159 x 100 x 75 (L x W x H), DIM053
Installation	DIN rail mounting following DIN 43880, top hat rail EN 50022
Purpose of control	Operating control
Construction of control	Independently mounted control
Feature of automatic action	Type 1
Operating conditions	0 °C to 50 °C, 10 – 90 % RH, noncondensing, degree of protection: IP40, IP20 (terminals), pollution degree 2
Power supply	24 VDC/ VAC SELV ±10 %, typ. 2.5 W
Rated Impulse Voltage	330 V

Specifications

Type	LROC-102
Interfaces	2 x Ethernet (100Base-T): Web services (OPC XML-DA, OPC UA), LonMark IP-852*, BACnet/IP**, BACnet/SC**, LIOB-IP, KNXnet/IP, Modbus TCP (Master or Slave), HTTP, FTP, SSH, HTTPS, Firewall, SNMP 1 x LIOB-Connect 2 x USB-A: WLAN (needs LWLAN-800), EnOcean (needs LENO-80x), MP-Bus (needs LMPBUS-804), SMI (needs LSMI-804), LTE (needs LTE-800), RS-232 (needs LRS232-802) 1 x TP/FT-10* (LonMark System) 1 x LIOB-FT 2 x RS-485 (ANSI TIA/EIA-485): BACnet MS/TP** or Modbus RTU/ASCII (Master or Slave) 2 x EXT: M-Bus, Master EN 13757-3 (needs L-MBUS20 or L-MBUS80) or KNX TP1 (needs LKNX-300) or SMI (needs LSMI-800)
	* Router between LonMark IP-852 and TP/FT-10 ** Router between BACnet/IP, BACnet/SC and BACnet MS/TP
L-IOB I/O Modules	Up to 24 L-IOB I/O Modules in any combination of type LIOB-10x/11x, LIOB-15x, and LIOB-45x/55x
BACnet/IP Router	1
LonMark CEA-709 Router	1
Program cycle time	Event-triggered
Programming, tools	L-STUDIO (IEC 61499 based)

Resource limits

Total number of data points	30 000	LonMark Schedulers	100
OPC data points	10 000	LonMark Alarm Servers	1
BACnet objects	4 000 (analog, binary, multi-state)	E-mail templates	100
BACnet client mappings	5 000	Math objects	100
BACnet calendar objects	25	Alarm logs	10
BACnet scheduler objects	100 (64 data points per object)	M-Bus data points	1 000
BACnet notification classes	32	Modbus data points	4 000
Trend logs (BACnet or generic)	512 (13 000 000 entries, ≈ 200 MB)	KNX TP1 data points	1 000
Total trended data points	2 000	KNXnet/IP data points	1 000
CEA-709 network variables (NVs)	2 000	Connections (Local / Global)	2 000 / 250
CEA-709 Alias NVs	2 000	Number of L-WEB clients	32 (simultaneously)
CEA-709 External NVs (polling)	1 000	L-IOB I/O Modules	24
CEA-709 address table entries	1 000 (non-ECS mode: 15)	Number of EnOcean devices	100
LonMark Calendars	1 (25 calendar patterns)	EnOcean data points	1 000
SMI devices (per channel)	16	MP-Bus devices (per channel)	8 (16 MPL)

Order number Product description

LROC-102	Room Controller for room segment, aisle, floor, building, or campus management
LROC-SEG8	License to add 8 segments to L-ROC Controller
L-STUDIO	Development and integration platform for programmable LOYTEC controllers
L-LIB-LROC	L-ROC Room Automation Library
LIOB-A2	L-IOB Adapter 2 to split the LIOB-Connect bus using 4-wire cables
LIOB-A4	L-IOB Adapter 4 to split the LIOB-Connect bus using RJ45 network cables
LIOB-A5	L-IOB Adapter 5 to terminate the LIOB-Connect bus

LROC-102

Order number	Product description
LIOB-100	LIOB-Connect I/O Module: 8 UI, 2 DI, 2 AO, 9 DO (5 x Relay 6 A, 4 x Triac 0.5 A)
LIOB-101	LIOB-Connect I/O Module: 8 UI, 16 DI
LIOB-102	LIOB-Connect I/O Module: 6 UI, 6 AO, 8 DO (8 x Relay 6 A)
LIOB-103	LIOB-Connect I/O Module: 6 UI, 6 AO, 5 DO (5 x Relay 16 A)
LIOB-110	LIOB-Connect I/O Module: 20 Universal I/O (IO)
LIOB-112	LIOB-Connect I/O Module: 40 Universal I/O (12 optionally with 4-20 mA Current Output)
LIOB-150	LIOB-FT I/O Module: 8 UI, 2 DI, 2 AO, 8 DO (4 x Relay 6 A, 4 x Triac 0.5 A)
LIOB-151	LIOB-FT I/O Module: 8 UI, 12 DI
LIOB-152	LIOB-FT I/O Module: 6 UI, 6 AO, 8 DO (8 x Relay 6 A)
LIOB-153	LIOB-FT I/O Module: 6 UI, 6 AO, 5 DO (4 x Relay 16 A, 1 x Relay 6 A)
LIOB-154	LIOB-FT I/O Module: 7 UI, 4 AO, 7 DO (5 x Relay 6 A, 2 x Triac 0.5 A), 1 Pressure Sensor
LIOB-450	LIOB-IP852 I/O Module: 8 UI, 2 DI, 2 AO, 8 DO (4 x Relay 6 A, 4 x Triac 0.5 A)
LIOB-451	LIOB-IP852 I/O Module: 8 UI, 12 DI
LIOB-452	LIOB-IP852 I/O Module: 6 UI, 6 AO, 8 DO (8 x Relay 6 A)
LIOB-453	LIOB-IP852 I/O Module: 6 UI, 6 AO, 5 DO (4 x Relay 16 A, 1 x Relay 6 A)
LIOB-454	LIOB-IP852 I/O Module: 7 UI, 4 AO, 7 DO (5 x Relay 6 A, 2 x Triac 0.5 A), 1 Pressure Sensor
LIOB-550	LIOB-BIP I/O Module: 8 UI, 2 DI, 2 AO, 8 DO (4 x Relay 6 A, 4 x Triac 0.5 A)
LIOB-551	LIOB-BIP I/O Module: 8 UI, 12 DI
LIOB-552	LIOB-BIP I/O Module: 6 UI, 6 AO, 8 DO (8 x Relay 6 A)
LIOB-553	LIOB-BIP I/O Module: 6 UI, 6 AO, 5 DO (4 x Relay 16 A, 1 x Relay 6 A)
LIOB-554	LIOB-BIP I/O Module: 7 UI, 4 AO, 7 DO (5 x Relay 6 A, 2 x Triac 0.5 A), 1 Pressure Sensor
LPOW-2415A	LIOB-Connect power supply unit, 24 VDC, 15 W
LPOW-2415B	Power supply unit with power connector 24 VDC, 15 W
L-MBUS20	M-Bus Level Converter, Interface for up to 20 M-Bus devices
L-MBUS80	M-Bus Level Converter, Interface for up to 80 M-Bus devices
LKNX-300	KNX interface to connect KNX TP1 devices
LENO-800	EnOcean Interface 868 MHz Europe
LENO-801	EnOcean Interface 902 MHz USA/Canada
LENO-802	EnOcean Interface 928 MHz Japan
LWLAN-800	Wireless LAN Interface IEEE 802.11bgn
LMPBUS-804	MP-Bus interface for 16 devices per channel, up to 4 channels
LSMI-800	Standard Motor Interface for 16 motors via EXT port
LSMI-804	Standard Motor Interface for 64 motors, 4 SMI channels via USB
LTE-800	LTE Interface
LRS232-802	USB to 2 x RS-232 Interface
LSTAT-800-G3-Lx	Room Operator Panel, black front, white enclosure, Modbus, temperature, rel. humidity, ext. switch/NTC, IR receiver, Buttons (Lx)
LSTAT-801-G3-Lx	Room Operator Panel, front black, white enclosure, Modbus, temperature, rel. humidity, ext. switch/NTC, occupancy, IR receiver, Buttons (Lx)
LSTAT-802-G3-Lx	Room Operator Panel, front black, white enclosure, Modbus, temperature, rel. humidity, ext. switch/NTC, occupancy, IR receiver, CO2, Buttons (Lx)
LSTAT-800-G3-L20x	Room Operator Panel, white front, white enclosure, Modbus, temperature, rel. humidity, ext. switch/NTC, IR receiver, Buttons (Lx)
LSTAT-801-G3-L20x	Room Operator Panel, white front, white enclosure, Modbus, temperature, rel. humidity, ext. switch/NTC, occupancy, IR receiver, Buttons (Lx)
LSTAT-802-G3-L20x	Room Operator Panel, white front, white enclosure, Modbus, temperature, rel. humidity, ext. switch/NTC, occupancy, IR receiver, CO2, Buttons (Lx)
LSTAT-80x-CUSTOM	One-time customization cost for L-STAT custom design, including 2 working samples

- ✓ BACnet
- ✓ CEA-709
- ✓ KNX

- ✓ Modbus
- ✓ M-Bus
- ✓ OPC



LROC-400, LROC-401, LROC-402

Datasheet #89036424



The L-ROC Room Controller provides the basis for a revolutionary room automation system based on IP, which seamlessly integrates with native BACnet/IP networks and LonMark Systems at the controller level. Together with the L-STUDIO software, flexible room solutions can be created and adapted to changing requirements during the project with little effort. Integral parts of the L-ROC system are a web-based room operation via an LWEB-802/803 dashboard and the automatic generation of graphics for the L-VIS Touch Panel for local operation.

Our room controllers provide all common interfaces and a large number of physical I/Os for room automation projects. KNX devices are integrated via the built-in KNX TP1 or the KNXnet/IP interface. DALI lamps and DALI sensors are connected to the DALI interface with an integrated DALI power supply. Up to 16 SMI sunblind motors connect to the SMI interface. Belimo valves connect to the MP-Bus interface. BACnet MS/TP devices connect to the RS-485 interface, which can also be configured as a Modbus RTU/ASCII interface to connect Modbus devices like energy meters or ekey finger scanner for access control. L-STAT room operator panels connect to the dedicated L-STAT interface. The EXT interface can connect 16 more SMI sunblind motors through the LSMI-800 interface or M-Bus meters through the L-MBUS20 interface. EnOcean devices connect to the EnOcean interface through an external antenna. Dual Ethernet ports allow daisy chaining of L-ROC controllers in a ring topology and provide BACnet/IP, LON/IP, Modbus/IP, KNXnet/IP and OPC communication. Optionally the L-ROC can communicate via wireless LAN through the LWLAN-800 wireless adapter connected to the USB port. 24 relay outputs, 8 TRIAC outputs, 8 analog outputs, 10 universal inputs and 2 digital inputs connect various physical inputs and outputs. Our room automation library provides pre built function modules for all lighting, heating, cooling, ventilation, sunblinds and access control via finger scanners. Built-in TSL encryption ensures secure operation of the room automation system.

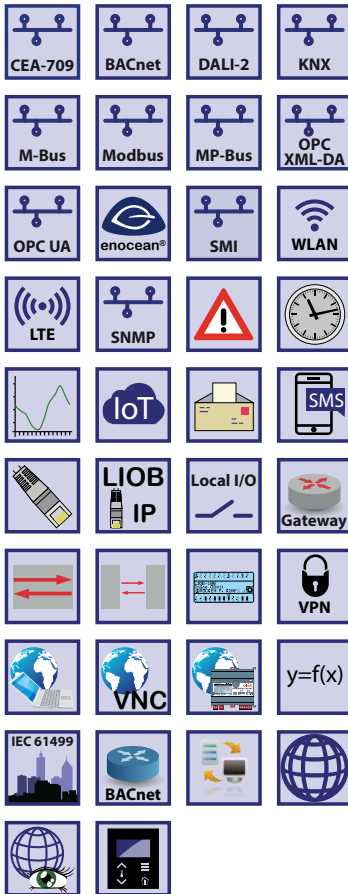

Flexible Room Concept for Room Automation

A room segment is the smallest individually controllable entity in the L-ROC System. The L-ROC Library provides a set of functions for every room segment including:

- Lighting control with constant light controller
- Sunblind control with angle adjustment and year shade progression
- Temperature control for heating, cooling, and ventilation
- Occupancy detection
- Window monitoring and window contact

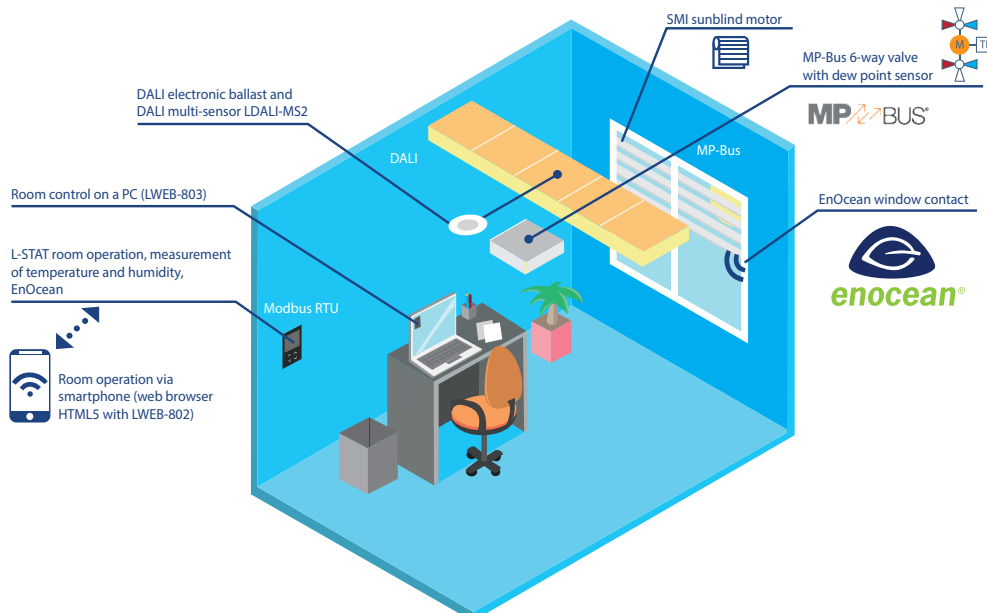

L-ROC Room Controller

LROC-400, LROC-401, LROC-402

Depending on the model an L-ROC Room Controller can control between 8 and 16 room segments. Based on the various room segment types, larger buildings can be modeled in a hierarchical manner. Areas are built with an area manager by combining multiple room controllers. A floor manager manages multiple areas in one floor. Depending on the architecture, the building can be split up into areas and floors as needed.

Area/Floor Managers are responsible for handling functions needed for corridor, staircase, and bathroom lighting, or even ventilation. Floor managers facilitate the data communication between the floors and handle floor relevant functions e.g. processing meter data.

Rooms can be created in any size by moving, installing, or removing partition walls. The resulting logical connections between the L-ROC Room Controllers will be built automatically. All graphical user interfaces and network connections are automatically generated and adapted respectively.

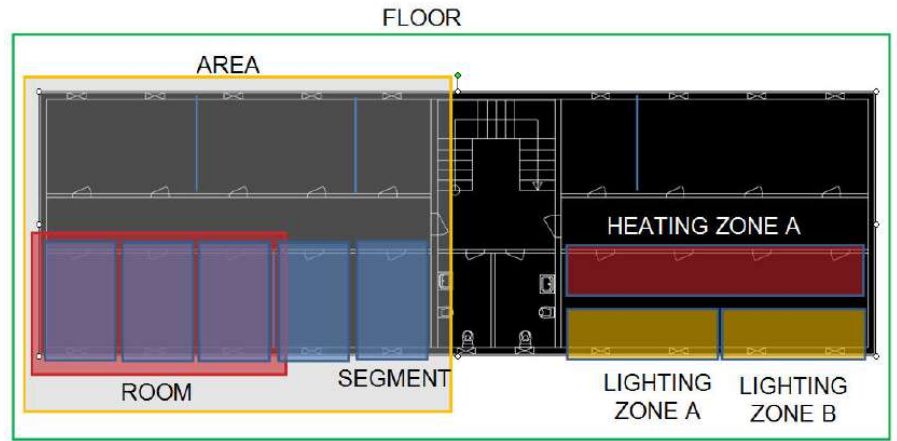

AST™ for every Room Segment

L-ROC provides a set of functions for Alarming, Scheduling, and Trending (AST™) for every room segment. Each room segment can be operated entirely independently. The AST™ functions are fully available to higher-level systems through BACnet/IP and web services (L-WEB System). Distributed schedulers can be efficiently managed and changed with LWEB-900.

Room Communication through redundant or separated IP Network

L-ROC Room Controllers are interconnected via a 100Base-T Ethernet network. Each L-ROC device is equipped with two Ethernet ports. It can either be configured to use the internal switch to interconnect the two ports or every port is configured to work in a separate IP network.

When the Ethernet ports are configured for two separate IP networks, one port can be connected for instance to a WAN (Wide Area Network) with enabled network security (HTTPS) while the second port can be configured to be connected to an insecure network (LAN) where the standard building automation protocols like BACnet/IP, LON/IP, or Modbus TCP are present. These devices also feature fire-wall functionality of course to isolate particular protocols or services between the ports. The built-in VPN function provides for simple VPN setup and secure access to remote sites. The LTE-800 interface enables wireless access to remote sites through a mobile carrier.

Using the internal switch, a daisy chained line topology of up to 20 devices can be built, which reduces costs for network installation. The IP switch also allows the setup of a redundant Ethernet installation (ring topology), which increases reliability. The redundant Ethernet topology is enabled by the Rapid Spanning Tree Protocol (RSTP), which is supported by most managed switches.



Integrated L-WEB Room Operation

L-ROC controllers provide graphical user interfaces for room operation directly via an IP connection to the user, without the need for an additional web server. Graphic projects are distributed among the L-ROC Room Controllers and can be accessed by LWEB-802/803 from any PC workstation, smart phone, or tablet PC running Android or iOS.



Integration of the L-STAT Room Operator Panel

Depending on the model, 8 to 16 L-STAT room operator panels can be integrated via the L-STAT interface per L-ROC Room Controller. In addition to the attractive, modern design and intuitive operation, L-STAT provides a range of features to individually increase the room comfort.

Internal sensors measure temperature, humidity, dew point, occupancy, and the CO₂ content of the air. There is also the possibility to control room functions via an IR remote control. Standard pushbuttons and external temperature sensors can be integrated through additional inputs.

Connection to Higher-Level Systems

Higher-level systems can seamlessly integrate L-ROC Room Controllers via BACnet/IP, LonMark IP-852, or web services (OPC).

All these protocols are simultaneously available. It is possible to integrate the L-ROC Room Controller in a BACnet Operator Workstation and at the same time L-ROC will communicate with other CEA-709 devices on the IP-852 channel. Moreover, a higher-level SCADA or ERP System (Facility Management) gets information directly from the L-ROC Room Controller by using web services based on OPC XML-DA or OPC UA.

Full LWEB-900 Support

The L-WEB System uses web services to communicate with the L-ROC System. All device and operating parameters of every single L-ROC Room Controller are automatically synchronized with the LWEB-900 SQL database. Controllers can be replaced from the database with a backup without user interaction.

I/O Integration via Plug and Play

The L-ROC Room Controllers can automatically integrate additional physical I/Os by using L-IOB I/O Modules. Up to 2 L-IOB I/O Modules can be connected through LIOB-IP. All I/Os can be used by the L-ROC application and are also available via the web interface of L-ROC. All configurations of the L-IOB Modules are stored on the L-ROC and loaded on demand into the L-IOB I/O Modules. Exchanging I/O modules is done without any configuration effort requiring only a few quick configuration steps.

L-STUDIO

L-STUDIO is the world's first IEC 61499 based room automation system. Any room function can be realized with L-STUDIO in a distributed system of L-ROC devices. We call this new approach in automation "Cloud Control". In a cloud of L-ROC devices, all automation functions are mapped automatically to physical hardware. The object-oriented design method allows the efficient reuse of previously implemented functions. In the graphical development environment of L-STUDIO, areas are created from room segment with just a few mouse clicks. The areas are interconnected to floors and multiple floors form a building. The entire building application is automatically distributed to the L-ROC Controllers installed in the building.

New functions can be added to the room segment objects after initial configuration. These new functions can be applied individually or to all room segment objects very easily. Comprehensive debugging and watch functions allow for complete building troubleshooting. An extensive library of functions is provided for heating, ventilation, cooling, lighting, sunblind control, and security. With the



integrated L-VIS/L-WEB Configurator, graphical pages for L-VIS Touch Panels and L-WEB applications can be customized.



Year Shade Progression

Especially in dense city areas, buildings can cast shadows on each other. In case a façade element is shaded by another building, sunblinds can be deactivated for better daylight harvesting. The high-performance L-ROC controllers allow to calculate a 3D model in dxf-Format of the building and its close-by neighbors. The model can be constructed using common 3D CAD software or can be derived from a Building Information Model. In case the scenery changes due to new constructions, only the new buildings have to be inserted in the model. The calculation can be done for each window individually or per shadowing zone.



IoT Integration

The IoT function (Node.js) allows connecting the system to almost any cloud service, either for uploading historical data to analytics services, telemetry using MQTT, delivering alarm messages to alarm processing services or operating parts of the control system over a cloud service (e.g., scheduling based on Web calendars or booking systems). Processing Internet information such as weather data in forecast-based control is also possible. Finally, the JavaScript kernel also allows implementing serial protocols to non-standard equipment in primary plant control.

Features

- Flexible built-in management for room segments
- Room controller for up to 8 or 16 room segments
- Networking via redundant IP network
- Programmable with L-STUDIO (IEC 61499)
- Extension with physical inputs and outputs using L-IOB I/O Modules (LIOB-45x or LIOB-55x)
- 128x64 graphic display with backlight for device configuration and maintenance
- Local display of device and data point information
- Manual operation using the jog dial or VNC Client
- Integrated AST™ functions (Alarming, Scheduling, and Trending) for each room segment
- Node.js support for easy IoT integration (e.g. Google calendar, MQTT, Alexa & friends, multimedia equipment,...)
- Event-driven e-mail notification
- Math objects to execute mathematical operations on data points
- Stores customized graphical pages
- Visualization of customized graphical pages through LWEB-900 (Building Management), LWEB-803 (Monitoring and Control), or LWEB-802 (Web Browser)
- Support of the L-STAT Room Operator Panel
- Built-in OPC XML-DA and OPC UA server
- Access to network statistics via SNMP
- Compliant with ANSI/ASHRAE 135-2012 and ISO 16484-5:2012 standard
- Supports BACnet/IP, BACnet/SC or BACnet MS/TP
- BACnet Client Function (Write Property, Read Property, COV Subscription)
- BACnet Client Configuration with configuration tool (scan and EDE import)
- B-BC (BACnet Building Controller) functionality, BTL certified
- Integrated BACnet/IP to BACnet/SC and BACnet MS/TP Router including BBMD as well as Slave-Proxy functionality
- Compliant with CEA-709, CEA-852, and ISO/IEC 14908 Standard (LonMark System)
- CEA-709 integration via LonMark IP-852 (Ethernet/IP) channel
- Support of dynamically created or static NVs
- Support of user-defined NVs (UNVTs) and Configuration Properties (SCPTs, UCPTs)
- Connection to KNXnet/IP and KNX TP1
- M-Bus Master according to EN 13757-3, connection via optional M-Bus Converter (L-MBUS20 or L-MBUS80)
- Gateway functions including Smart Auto-Connect™
- Modbus TCP and Modbus RTU/ASCII (Master or Slave)
- Integrated web server for device configuration and monitoring data points
- DALI integration of up to 64 DALI lamps (depending on the model)
- Integrated DALI power supply, 16 V DC, 230 mA guaranteed supply current, 250 mA max. supply current
- Test and assignment of DALI devices via the web interface
- Replacement of DALI devices without additional software tools via the graphic display and jog dial
- Supports up to 16 DALI sensors
- Supports up to 64 DALI pushbuttons
- Supports the control of standard loads in the power grid via LDALI-RM5/RM6/RM8 Relay Modules
- Supports DALI-2 devices (drivers and input devices)
- DALI-2 certified, compliant with IEC 62386-101 and IEC 62386-103 (only LROC-400, LROC-401)

LROC-400, LROC-401, LROC-402

- Support DALI color control (DT8 tunable white & full color control)
- Supports lamp burn-in mode
- Supports periodic testing of DALI emergency lights
- Integrated DALI Protocol Analyzer
- Connection to EnOcean wireless devices (built-in EnOcean interface with external antenna for Europe, 868 MHz) or via LENO-80x (LROC-402 only)
- Supports WLAN through LWLAN-800 Interface
- Integration of actuators via MP-Bus (expandable via LMPBUS-804)
- Supports SMI (Standard Motor Interface):
LROC-400, LROC-401: built-in (expandable via LSMI-80x)
LROC-402: needs LSMI-804
- Supports LTE through LTE-800 Interface
- Supports RS-232 through LRS232-802 Interface
- Stores user-defined project documentation
- Configurable Bluetooth beacons and services: indoor navigation, asset tracking (requires LIC-ASSET license) and access to LWEB-900 room control solution (only LROC-400, LROC-401)

General Specifications

Dimensions (mm)	340 x 144 x 70 (L x W x H), DIM047
Installation	mountable directly via two oblong holes (ø 7 mm, distance 315 mm) or system distribution box LBOX-ROCx, DIM048
Power supply	24 VDC ±10 % or 85 – 240 VAC, 50 – 60 Hz (do not connect 24 VDC if SMI or DALI are used)
Operating conditions	0 °C to 40 °C, 10 – 90 % RH, noncondensing, degree of protection: IP40, IP20 (terminals)

Specifications

Type	LROC-400	LROC-401	LROC-402
Power consumption	max 15 W	max 15 W	max 15 W
Interfaces	2 x Ethernet (100Base-T): Web services (OPC XML-DA, OPC UA), LonMark IP-852, BACnet/IP*, BACnet/SC*, LIOB-IP, KNXnet/IP, Modbus TCP (Master or Slave), HTTP, FTP, SSH, HTTPS, Firewall, VNC, SNMP 1 x L-STAT (Room Operator Panel) 1 x MP-Bus (actuator) 1 x KNX TP1 2 x USB-A: WLAN (needs LWLAN-800), MP-Bus (needs LMPBUS-804), SMI (needs LSMI-804), LTE (needs LTE-800) RS-232 (needs LRS232-802)	2 x USB-A: WLAN (needs LWLAN-800), MP-Bus (needs LMPBUS-804), SMI (needs LSMI-804), LTE (needs LTE-800) RS-232 (needs LRS232-802)	2 x USB-A: WLAN (needs LWLAN-800), MP-Bus (needs LMPBUS-804), EnOcean (needs LENO-80x), SMI (needs LSMI-804), LTE (needs LTE-800) RS-232 (needs LRS232-802)
	1 x RS-485 (ANSI TIA/EIA-485): BACnet MS/TP* or Modbus RTU/ASCII (Master or Slave) 1 x DALI with integrated DALI bus power supply 16 VDC, 230 mA guaranteed supply current,** 250 mA max. supply current 1 x SMI (Standard Motor Interface Master) 1 x EnOcean (Europe 868 MHz) with external antenna 1 x EXT: M-Bus, Master EN 13757-3 (needs LMBUS-20 or LMBUS-80) or SMI (needs LSMI-800)	1 x RS-485 (ANSI TIA/EIA-485): BACnet MS/TP* or Modbus RTU/ASCII (Master or Slave) 1 x DALI with integrated DALI bus power supply 16 VDC, 230 mA guaranteed supply current,** 250 mA max. supply current 1 x SMI (Standard Motor Interface Master) 1 x EnOcean (Europe 868 MHz) with external antenna 1 x EXT: M-Bus, Master EN 13757-3 (needs LMBUS-20 or LMBUS-80) or SMI (needs LSMI-800)	–

* Router between BACnet/IP and BACnet MS/TP

***With high DALI traffic (e.g. during DALI-scan) increased current consumption may occur depending on the devices connected. Therefore, according to IEC62386-101 it is recommended to take an additional current of at least 20% for dynamic processes into account in system design.

LROC-400, LROC-401, LROC-402

Specifications			
Type	LROC-400	LROC-401	LROC-402
Universal Input (UI)	10	0	10
Digital Input (DI)	2	0	2
Analog Output (AO)	8	0	8
Digital Output (DO)	32 (24 x Relay, 8 x Triac)	0	32 (24 x Relay, 8 x Triac)
Digital Output specification	Relay: 10 A Triac: 0.5 A @ 24–240 VAC	-	Relay: 10 A Triac: 0.5 A @ 24–240 VAC
Please refer to the “General Input and Output Specification of LOYTEC devices” at the end of the L-IOB section for more details.			
Frequency	868.3 MHz	868.3 MHz	-
RF Output Power	3 dBm	3 dBm	-
L-IOB I/O extension	2 L-IOB I/O Modules of Type LIOB-45x or LIOB-55x		
BACnet/IP Router	1		
Program cycle time	Event-triggered		
Programming, Tools	L-STUDIO (IEC 61499 based)		
Max. number of Rooms/Segments	8	16	8
SMI devices (via built-in interface)	1 x 16	1 x 16	-
SMI devices via LSMI-800	1 x 16	1 x 16	1 x 16
SMI devices via LSMI-804	4 x 16	4 x 16	4 x 16
SMI devices (maximum)	96	96	64
EnOcean devices (via built-in interface)	32	64	-
EnOcean devices via LENO-80x	-	-	32
EnOcean devices (maximum)	64	64	64
EnOcean devices commissioning limit	32	64	32
L-STAT Room Operator Panels	8	16	8
DALI devices	64	64	-
DALI groups	16	16	-
DALI sensors	16	16	-
DALI pushbuttons (LDALI-BM2)	64 pushbutton coupler	64 pushbutton coupler	-
MP-Bus devices (via built-in interface)	1 x 8 (16 MPL)	1 x 8 (16 MPL)	1 x 8 (16 MPL)
MP-Bus devices via LMPBUS-804	4 x 8 (16 MPL)	4 x 8 (16 MPL)	4 x 8 (16 MPL)
MP-Bus devices (maximum)	80	80	80

Resource limits			
Total number of data points	30 000	LonMark Alarm Servers	1
OPC data points	10 000	E-mail templates	100
BACnet objects	4 000 (analog, binary, multi-state)	Math objects	100
BACnet client mappings	5 000	Alarm logs	10
BACnet calendar objects	25	M-Bus data points	1 000
BACnet scheduler objects	100 (64 data points per object)	Modbus data points	2 000
BACnet notification classes	32	KNX TP1 data points	1 000
Trend logs (BACnet or generic)	512 (13 000 000 entries, ≈ 200 MB)	KNXnet/IP data points	1 000
Total trended data points	2 000	Connections (Local / Global)	2 000 / 250
CEA-709 network variables (NVs)	2 000	Number of L-WEB clients	32 (simultaneously)
CEA-709 Alias NVs	2 000	L-IOB I/O Modules (via LIOB-IP)	2
CEA-709 External NVs (polling)	1 000	EnOcean data points	10 per EnOcean device
CEA-709 address table entries	1 000 (non-ECS mode: 15)	SMI devices (per channel)	16
LonMark Calendars	1 (25 calendar patterns)	MP-Bus devices (per channel)	8 (16 MPL)
LonMark Scheduler	100		

LROC-400, LROC-401, LROC-402

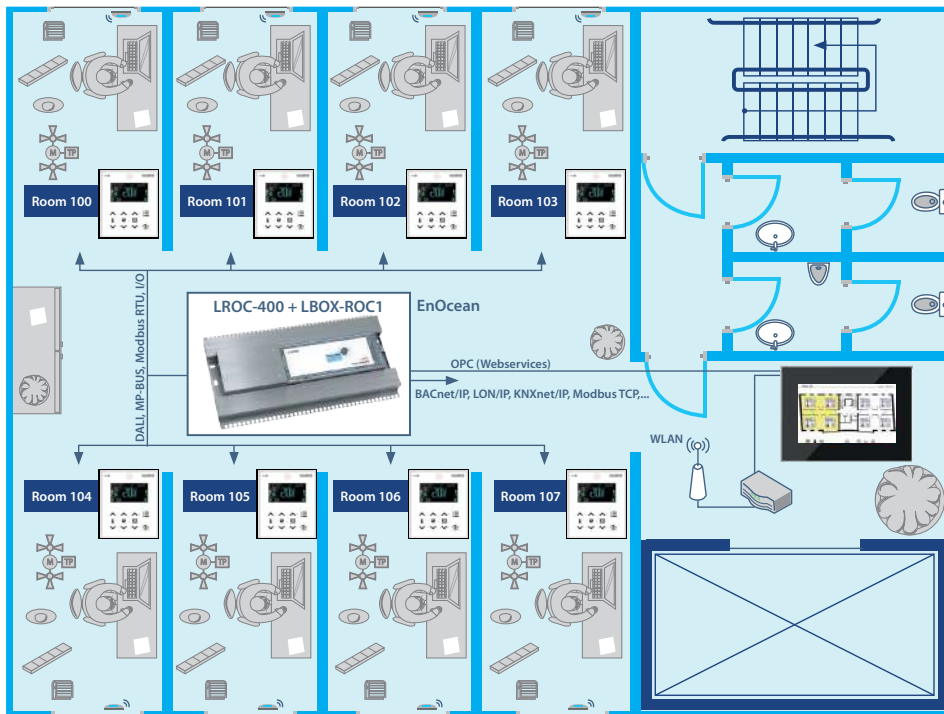

Application example: Creating a new floor plan by simply changing room numbers (here: 8 single offices)

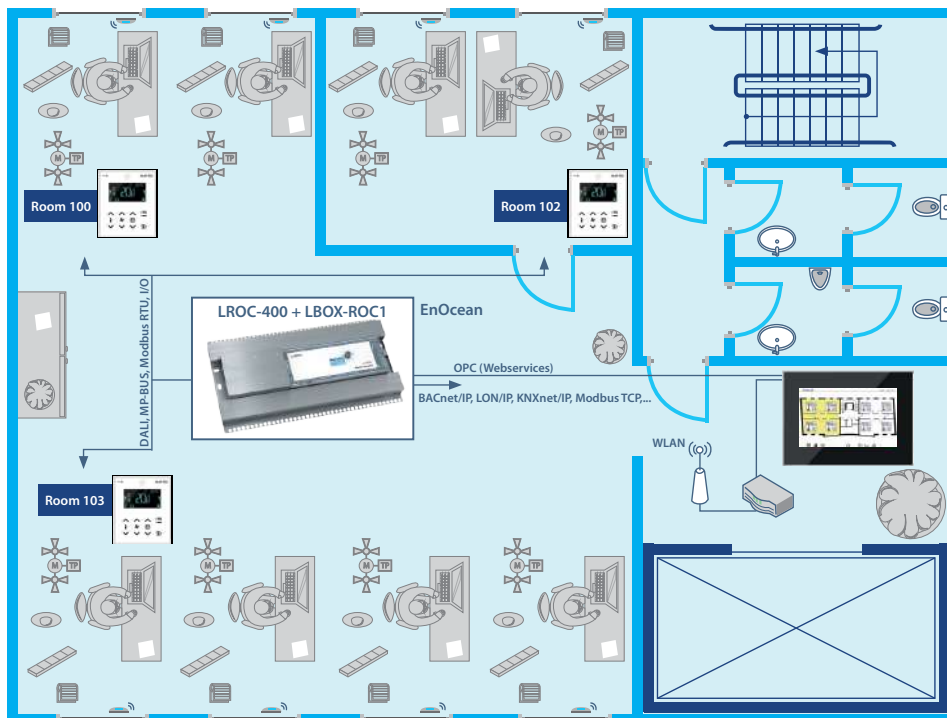

Application example for 8 segments (1 open plan office, 1 single office)

Order number	Product description
LROC-400	Room Controller for room segment, aisle, floor, building, or campus management
LROC-401	Room Controller for room segment, aisle, floor, building, or campus management
LROC-402	Room Controller for room segment, aisle, floor, building, or campus management
LBOX-ROC1	System Distribution Box for LROC-40x Room Controller, 519 x 280 x 71 (L x W x H in mm)
LBOX-ROC2	System Distribution Box for LROC-40x Room Controller, 60 W 24 VDC power supply

LROC-400, LROC-401, LROC-402

Order number	Product description
LROC-SEG8	License to add 8 segments to L-ROC Controller
LIC-ASSET	Add-on Software License to activate asset tracking (for LDALI-ME20x-U, LDALI-3E10x-U, LDALI-PLCx, LROC-400, LROC-401, LIOB-AIR20, LIOB-591)
L-STUDIO	Development and integration platform for programmable LOYTEC controllers
L-LIB-LROC	L-ROC Room Automation Library
LSTAT-800-G3-Lx	Room Operator Panel, black front, white enclosure, Modbus, temperature, rel. humidity, ext. switch/NTC, IR receiver, Buttons (Lx)
LSTAT-801-G3-Lx	Room Operator Panel, front black, white enclosure, Modbus, temperature, rel. humidity, ext. switch/NTC, occupancy, IR receiver, Buttons (Lx)
LSTAT-802-G3-Lx	Room Operator Panel, front black, white enclosure, Modbus, temperature, rel. humidity, ext. switch/NTC, occupancy, IR receiver, CO2, Buttons (Lx)
LSTAT-800-G3-L20x	Room Operator Panel, white front, white enclosure, Modbus, temperature, rel. humidity, ext. switch/NTC, IR receiver, Buttons (Lx)
LSTAT-801-G3-L20x	Room Operator Panel, white front, white enclosure, Modbus, temperature, rel. humidity, ext. switch/NTC, occupancy, IR receiver, Buttons (Lx)
LSTAT-802-G3-L20x	Room Operator Panel, white front, white enclosure, Modbus, temperature, rel. humidity, ext. switch/NTC, occupancy, IR receiver, CO2, Buttons (Lx)
LSTAT-810-G3-L0	Remote EnOcean Antenna, Europe, white
LSTAT-820-G3-L0	Remote EnOcean Antenna, USA/CA, white
LSTAT-830-G3-L0	Remote EnOcean Antenna, Japan, white
LSTAT-80x-CUSTOM	One-time customization cost for L-STAT custom design, including 2 working samples
LDALI-MS2-BT	DALI multi-sensor (presence detection, illuminance sensor, IR receiver, temperature sensor, humidity sensor, 3 digital inputs, Bluetooth), up to 12 m mounting height
LDALI-MS3-BT	DALI multi-sensor (presence detection, illuminance sensor, IR receiver, temperature sensor, humidity sensor, 3 digital inputs, Bluetooth), up to 12 m mounting height
LDALI-MS4-BT	DALI multi-sensor (presence detection, illuminance sensor, IR receiver, temperature sensor, humidity sensor, 3 digital inputs, Bluetooth, flat lense), up to 5 m mounting height
LDALI-BM2	Quadruple DALI pushbutton coupler
LDALI-RM5	DALI Relay Module 10 A, Analog Interface 1 – 10 V
LDALI-RM6	DALI Relay Module 10 A, Analog Interface 1 – 10 V, "spud-mount"
LDALI-RM8	DALI Relay Module, 8-channel
LDALI-PD1	DALI Phase-Cut Dimmer Module
LDALI-PWM4	PWM module, DALI, 4 x 3 A LED outputs, 24 V DC ext.
LDALI-PWM4-TC	PWM module tunable white, DALI, 4 x 3 A LED outputs, 24 V DC ext.
LDALI-PWM4-RGBW	PWM module RGBW, DALI, 4 x 3 A LED outputs, 24 V DC ext.
L-TEMP2	External temperature sensor (NTC10K) for use with L-IOB Universal Inputs
L-MBUS20	M-Bus Level Converter, Interface for up to 20 M-Bus devices
L-MBUS80	M-Bus Level Converter, Interface for up to 80 M-Bus devices
LENO-800	EnOcean Interface 868 MHz Europe
LENO-801	EnOcean Interface 902 MHz USA/Canada
LENO-802	EnOcean Interface 928 MHz Japan
LWLAN-800	Wireless LAN Interface IEEE 802.11 bgn
LMPBUS-804	MP-Bus interface for 16 devices per channel, up to 4 channels
LSMI-800	Standard Motor Interface for 16 motors via EXT port
LSMI-804	Standard Motor Interface for 64 motors, 4 SMI channels via USB
LTE-800	LTE Interface
LRS232-802	USB to 2 x RS-232 Interface



L-INX Automation Servers

L-INX Automation Server

L-INX Overview

L-INX Automation Servers are automation stations with a high degree of integration and flexibility. They provide solutions for the following fields of activities:

- Multi-protocol applications with data points of different technologies: CEA-709 (LonMark systems), BACnet, KNX, Modbus, M-Bus, MP-Bus, EnOcean, SMI
- Direct integration of physical in- and outputs as data points
- Visualization of data points on PCs or mobile devices with LOYTEC L-WEB software or in OPC SCADA software bundles
- Automation of single rooms up to primary plants using IEC 61131 programs
- Used in environments with increased network security requirements
- Basic automation functions: Alarming, Scheduling, historical Trending
- Event- or time-driven e-mail notifications for alarms or historical data
- Universal gateway for the connection of data points of supported network technologies

Configuration

For basic configuration, the L-INX offers a web interface and local operations via an LCD display using the built-in jog dial. The advanced configuration is carried out with the L-INX Configurator Software. Data points are created manually, through importing of device templates, data point lists or reading data from connected devices. In LonMark systems, data points can be extracted from the LNS database and necessary bindings can be managed.

Automation Server

Data points are alarmed, scheduled, and recorded in the automation server. Alarms can be acknowledged and recorded in a local alarm log. Through schedulers and calendars, data points can be allocated with values at certain points in time. The internal clock can be synchronized via NTP or the LonMark Real-Time Keeper. Historical data point values can be recorded periodically, after a value change, or can be triggered. Mathematical objects allow easy calculations and the built-in e-mail client sends notifications e.g. triggered by alarms. Recorded data can be attached to the e-mail as CSV file.

Programmable logic

Beyond automation functions, there are L-INX models featuring a programmable logic controller (PLC) on a data point basis. It is developed with L-STUDIO according to IEC 61131-3 and is able to implement practically any logic via function block diagram or structured text. The data points of the L-INX serve as input, output or flag variables. As data points are generic, the program logic can be developed once and later be adapted to different systems. The PLC can also access terminals that are directly connected to the L-INX via L-IOB I/O modules. LOYTEC offers a library for building automation and HVAC that provides ready-made solutions for typical applications. For details please check the L-STUDIO section (page 31-32).

Network Security

Nowadays, network security in building automation experiences increased attention. To facilitate system improvements for the integrator, the L-INX features a Secure Mode. Once activated, the L-INX activates an integrated firewall that blocks all unsecure accesses. To ensure authenticity of the data, individual certificates from a certification authority can be requested. The server certificate particularly provides an added value for mobile devices. Thereby, they can verify that they are connected with an authorized L-INX. For OPC based SCADA and visualization packets, the L-INX offers the implementation of Secure Channel with OPC UA that allows encryption and authentication for clients through certificates.

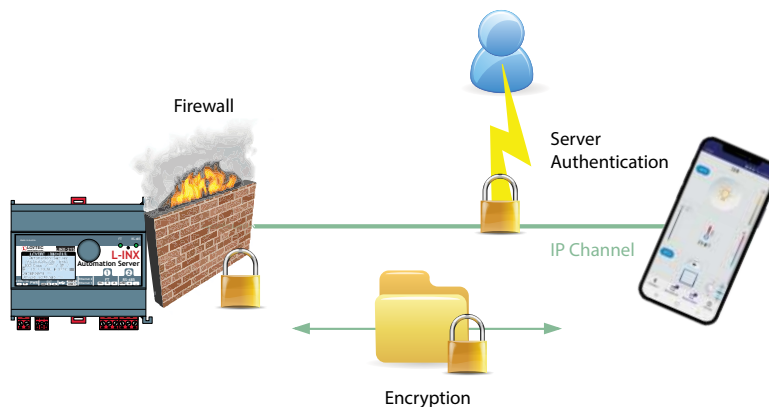

- ✓ BACnet
- ✓ CEA-709
- ✓ KNX
- ✓ Modbus
- ✓ M-Bus
- ✓ OPC
- ✓ MP-Bus



L-INX Automation Server

LINX-153, LINX-154

Datasheet #89047923

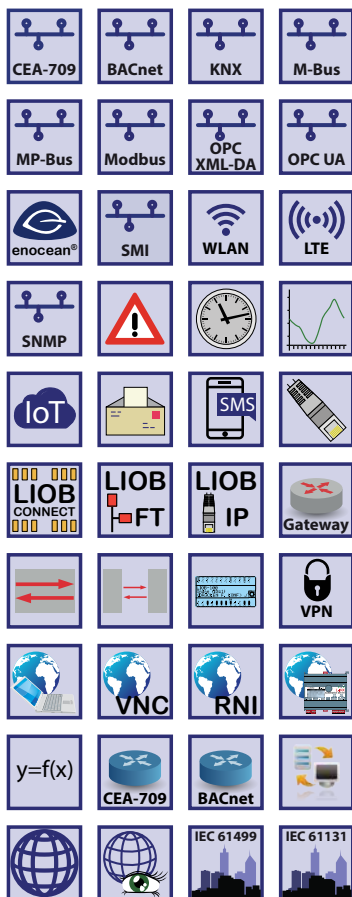
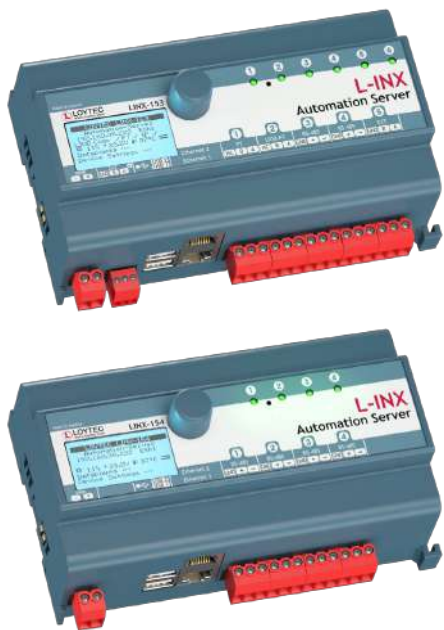

The L-INX Automation Servers LINX-153 and LINX-154 are powerful, programmable automation stations, which can be programmed by L-STUDIO. The L-INX Automation Servers can host user specific graphical pages and can integrate physical I/Os through L-IOB I/O Modules via LIOB-Connect, LIOB-FT, or LIOB-IP. The LINX-154 can only be extended by LIOB-IP. Local operation and override is provided by the built-in jog dial and the backlit display (128x64 pixels). Device and data point information is shown on the display via symbols and in text format.

The powerful Automation Servers provide connectivity functions to concurrently integrate CEA-709 (LonMark Systems), BACnet, KNX, Modbus, and M-Bus subsystems. LonMark Systems can be integrated via IP-852 (Ethernet/IP) or TP/FT-10. BACnet integration is supported through BACnet/IP (Ethernet/IP) or BACnet MS/TP (RS-485). LINX-153 Automation Servers feature an integrated Remote Network Interface (RNI) to access the TP/FT-10 channel on the device via Ethernet/IP. LINX-153 and LINX-154 Automation Servers feature a BACnet/SC router, BACnet/IP router including BBMD as well as Slave-Proxy functionality, providing the complete feature set of the corresponding L-IP devices.

The LINX-153 and LINX-154 implement the BACnet Building Controller (B-BC) profile and are BTL certified. In addition, the LINX-15x provide connectivity to KNXnet/IP (only LINX-153) and Modbus TCP via Ethernet/IP and to Modbus RTU/ASCII via RS-485. M-Bus and KNX TP1 (only for LINX-153) device integration needs optional interface modules.

The gateway functionality allows data communication between all communication technologies available on the device. Different technology data points are mapped through Local Connections on the device. The mapping of different technology data points on distributed devices is supported by Global Connections. L-INX Automation Servers also support Smart Auto-Connect™ – the automatic generation of connections to substantially reduce engineering efforts and cost. All technology data points are automatically created as OPC XML-DA and OPC UA data points.

Each L-INX Automation Server is equipped with two Ethernet ports. It can either be configured to use the internal switch to interconnect the two ports or every port is configured to work in a separate IP network.

When the Ethernet ports are configured for two separate IP networks, one port can be connected for instance to a WAN (Wide Area Network) with enabled network security (HTTPS) while the second port can be configured to be connected to an insecure network (LAN) where the standard building automation protocols like BACnet/IP, LON/IP, or Modbus TCP are present. These devices also feature fire-wall functionality of course to isolate particular protocols or services between the ports. The built-in VPN function provides for simple VPN setup and secure access to remote sites. The LTE-800 interface enables wireless access to remote sites through a mobile carrier.

Using the internal switch, a daisy chained line topology of up to 20 devices can be built, which reduces costs for network installation. The IP switch also allows the setup of a redundant Ethernet installation (ring topology), which increases reliability. The redundant Ethernet topology is enabled by the Rapid Spanning Tree Protocol (RSTP), which is supported by most managed switches.

The L-INX devices provide fully featured AST™ functionality (Alarming, Scheduling, and Trending) and can be integrated perfectly into the L-WEB System.

IoT Integration

The IoT function (Node.js) allows connecting the system to almost any cloud service, either for uploading historical data to analytics services, telemetry using MQTT, delivering alarm messages to alarm processing services or operating parts of the control system over a cloud service (e.g., scheduling based on Web calendars or booking systems). Processing Internet information such as weather data in forecast-based control is also possible. Finally, the JavaScript kernel also allows implementing serial protocols to non-standard equipment in primary plant control.

- Functions
- L-WEB, L-STUDIO
- L-ROC
- L-INX
- L-IOB
- Gateways
- L-VIS, L-STAT
- L-DALI
- Routers, NIC
- Interfaces
- Accessories

Features

- Programmable with L-STUDIO IEC 61131-3 and IEC 61499
- Room controller for up to 8 room segments
- Physical inputs and outputs with L-IOB I/O Modules (LIOB-10x/11x, LIOB-15x, and LIOB-45x/55x for LINX-153) (LIOB-45x/55x for LINX-154)
- 128x64 graphic display with backlight
- Local and remote access to information about device status and data points
- Manual operation using the jog dial or VNC client
- Alarming, Scheduling, and Trending (AST™)
- Node.js support for easy IoT integration (e.g. Google calendar, MQTT, Alexa & friends, multimedia equipment,...)
- Event-driven e-mail notification
- Math objects to execute mathematical operations on data points
- Stores customized graphical pages
- Visualization of customized graphical pages through LWEB-900 (Building Management), LWEB-803 (Monitoring and Control), or LWEB-802 (Web Browser)
- Built-in OPC XML-DA and OPC UA server
- Dual Ethernet/IP interface
- Access to network statistics
- Compliant with ANSI/ASHRAE 135-2012 and ISO 16484-5:2012 standard
- Supports BACnet MS/TP, BACnet/IP and BACnet/SC
- BACnet Client Function (Write Property, Read Property, COV Subscription)
- BACnet Client Configuration with configuration tool (scan and EDE import)
- B-BC (BACnet Building Controller) functionality, BTL certified
- Compliant with CEA-709, CEA-852, and ISO/IEC 14908 Standard (LonMark System)
- Supports TP/FT-10 (only LINX-153)
- Support of dynamically created or static NVs
- Support of user-defined NVs (UNVTs) and Configuration Properties (SCPTs, UCPTs)
- Remote Network Interface (RNI) with 2 MNI devices (only LINX-153)
- Integrated BACnet/IP to BACnet/SC and BACnet MS/TP Router including BBMD as well as Slave-Proxy functionality
- Integrated IP-852 to TP/FT-10 Router (only LINX-153)
- KNXnet/IP, connection to KNX TP1 through LKNX-300 Interface (only LINX-153)
- M-Bus Master according to EN 13757-3, connection via optional M-Bus Converter (only LINX-153) (L-MBUS20 or L-MBUS80)
- Gateway functions including Smart Auto-Connect™
- Modbus TCP and Modbus RTU/ASCII (Master or Slave)
- Integrated web server for device configuration and monitoring data points
- Configurable via TP/FT-10 (only LINX-153) or Ethernet/IP
- Connection to EnOcean wireless devices via LENO-80x Interface (only LINX-153)
- Supports SMI (Standard Motor Interface) through LSMI-800 or LSMI-804 (only LINX-153)
- Supports MP-Bus through LMPBUS-804 Interface (only LINX-153)
- Supports WLAN through LWLAN-800 Interface
- Supports LTE through LTE-800 Interface
- Supports RS-232 through LRS232-802 Interface (only LINX-153)
- Stores user-defined project documentation

Specifications LINX-153

Dimensions (mm)	159 x 100 x 75 (L x W x H), DIM053	
Installation	DIN rail mounting following DIN 43880, top hat rail EN 50022	
Purpose of control	Operating control	
Construction of control	Independently mounted control	
Feature of automatic action	Type 1	
Operating conditions	0 °C to 50 °C, 10–90 % RH, noncondensing, degree of protection: IP40, IP20 (terminals), pollution degree 2	
Power supply	24 VDC/ VAC SELV ±10 % via L-POW, or with an external power supply, typ. 2.5 W	
Rated Impulse Voltage	330 V	
Interfaces (LINX-153)	2 x Ethernet (100Base-T): OPC XML-DA, OPC UA, LonMark IP-852, BACnet/IP, BACnet/SC LIOB-IP, KNXnet/IP, Modbus TCP (Master or Slave), HTTP, FTP, SSH, HTTPS, Firewall, VNC, SNMP 1 x LIOB-Connect 1 x TP/FT-10 (LonMark System) 1 x LIOB-FT	2 x RS-485 (ANSI TIA/EIA-485): BACnet MS/TP or Modbus RTU/ASCII (Master or Slave) 2 x EXT: M-Bus, Master EN 13757-3 (needs L-MBUS20 or L-MBUS80) or KNX TP1 (needs LKNX-300) or SMI (needs LSMI-800) 2 x USB-A: WLAN (needs LWLAN-800), EnOcean (needs LENO-80x), SMI (needs LSMI-804), MP-Bus (needs LMPBUS-804) LTE (needs LTE-800) RS-232 (needs LRS232-802)
L-IOB I/O Modules	Up to 24 L-IOB I/O Modules in any combination of type LIOB-10x/11x, LIOB-15x, and LIOB-45x/55x	
Remote Network Interface	1 RNI with 2 MNI devices	
BACnet/IP Router	1	
CEA-709 Router	1	
Program cycle time	Down to 10 ms	
Max. number of Rooms/Segments	8	

Specifications LINX-154

Dimensions (mm)	159 x 100 x 75 (L x W x H), DIM054	
Installation	DIN rail mounting following DIN 43880, top hat rail EN 50022	
Purpose of control	Operating control	
Construction of control	Independently mounted control	
Feature of automatic action	Type 1	
Operating conditions	0 °C to 50 °C, 10–90 % RH, noncondensing, degree of protection: IP40, IP20 (terminals), pollution degree 2	
Power supply	24 VDC/ VAC SELV ±10 % via L-POW, or with an external power supply, typ. 2.5 W	
Rated Impulse Voltage	330 V	
Interfaces (LINX-154)	2 x Ethernet (100Base-T): OPC XML-DA, OPC UA, LonMark IP-852, BACnet/IP, BACnet/SC LIOB-IP, Modbus TCP (Master or Slave), HTTP, FTP, SSH, HTTPS, Firewall, VNC, SNMP	4 x RS-485 (ANSI TIA/EIA-485): BACnet MS/TP or Modbus RTU/ASCII (Master or Slave) 2 x USB-A: WLAN (needs LWLAN-800) LTE (needs LTE-800)
L-IOB I/O Modules	Up to 24 L-IOB I/O Modules in any combination of type LIOB-45x/55x	
BACnet/IP Router	1	
Program cycle time	Down to 10 ms	
Max. number of Rooms/Segments	8	

L-INX Automation Server

LINX-153, LINX-154

Runtime licenses

Type	LINX-153	LINX-154
Programming, Tools	L-STUDIO (IEC 61131-3 and IEC 61499 based), L-INX Configurator	
License	L-STUDIO: included	L-STUDIO: included

Resource limits LINX-153

Total number of data points	30 000	LonMark Schedulers	100
OPC data points	10 000	LonMark Alarm Servers	1
BACnet objects	2 000 (analog, binary, multi-state)	E-mail templates	100
BACnet client mappings	5 000	Math objects	100
BACnet calendar objects	25	Alarm logs	10
BACnet scheduler objects	100 (64 data points per object)	M-Bus data points	1 000
BACnet notification classes	32	Modbus data points	2 000
Trend logs (BACnet or generic)	512 (13 000 000 entries, ≈ 200 MB)	MP-Bus devices (per channel)	16
Total trended data points	2 000	KNX TP1 data points	1 000
CEA-709 network variables (NVs)	2 000	KNXnet/IP data points	1 000
CEA-709 Alias NVs	2 000	Connections (Local / Global)	2 000 / 250
CEA-709 External NVs (polling)	2 000	Number of L-WEB clients	32 (simultaneously)
CEA-709 address table entries	1 000 (non-ECS mode: 15)	L-IOB I/O Modules	24
LonMark Calendars	1 (25 calendar patterns)	Number of EnOcean devices	100
SMI devices (per channel)	16	EnOcean data points	1 000

Resource limits LINX-154

Total number of data points	30 000	CEA-709 address table entries	1 000 (non-ECS mode: 15)
OPC data points	10 000	LonMark Calendars	1 (25 calendar patterns)
BACnet objects	2 000 (analog, binary, multi-state)	LonMark Schedulers	100
BACnet client mappings	5 000	LonMark Alarm Servers	1
BACnet calendar objects	25	E-mail templates	100
BACnet scheduler objects	100 (64 data points per object)	Math objects	100
BACnet notification classes	32	Alarm logs	10
Trend logs (BACnet or generic)	512 (13 000 000 entries, ≈ 200 MB)	Modbus data points	5 000
Total trended data points	2 000	Connections (Local / Global)	2 000 / 250
CEA-709 network variables (NVs)	2 000	Number of L-WEB clients	32 (simultaneously)
CEA-709 Alias NVs	2 000	L-IOB I/O Modules	24
CEA-709 External NVs (polling)	2 000		



Order number	Product description
LINX-153	BACnet & CEA-709 Automation Server with LIOB-Connect and 61131-3 programming in L-STUDIO
LINX-154	BACnet Automation Server with 4 RS-485 channels
L-STUDIO	Development and integration platform for programmable LOYTEC controllers
LIOB-A2	L-IOB Adapter 2 to split the LIOB-Connect bus using 4-wire cables
LIOB-A4	L-IOB Adapter 4 to split the LIOB-Connect bus using RJ45 network cables
LIOB-A5	L-IOB Adapter 5 to terminate the LIOB-Connect bus
LIOB-100	LIOB-Connect I/O Module: 8 UI, 2 DI, 2 AO, 9 DO (5 x Relay 6 A, 4 x Triac 0.5 A)
LIOB-101	LIOB-Connect I/O Module: 8 UI, 16 DI
LIOB-102	LIOB-Connect I/O Module: 6 UI, 6 AO, 8 DO (8 x Relay 6 A)
LIOB-103	LIOB-Connect I/O Module: 6 UI, 6 AO, 5 DO (5 x Relay 16 A)
LIOB-110	LIOB-Connect I/O Module: 20 Universal I/O (IO)
LIOB-112	LIOB-Connect I/O Module: 40 Universal I/O (12 optionally with 4-20 mA Current Output)
LIOB-150	LIOB-FT I/O Module: 8 UI, 2 DI, 2 AO, 8 DO (4 x Relay 6 A, 4 x Triac 0.5 A)
LIOB-151	LIOB-FT I/O Module: 8 UI, 12 DI
LIOB-152	LIOB-FT I/O Module: 6 UI, 6 AO, 8 DO (8 x Relay 6 A)
LIOB-153	LIOB-FT I/O Module: 6 UI, 6 AO, 5 DO (4 x Relay 16 A, 1 x Relay 6 A)
LIOB-154	LIOB-FT I/O Module: 7 UI, 4 AO, 7 DO (5 x Relay 6 A, 2 x Triac 0.5 A), 1 Pressure Sensor
LIOB-450	LIOB-IP852 I/O Module: 8 UI, 2 DI, 2 AO, 8 DO (4 x Relay 6 A, 4 x Triac 0.5 A)
LIOB-451	LIOB-IP852 I/O Module: 8 UI, 12 DI
LIOB-452	LIOB-IP852 I/O Module: 6 UI, 6 AO, 8 DO (8 x Relay 6 A)
LIOB-453	LIOB-IP852 I/O Module: 6 UI, 6 AO, 5 DO (4 x Relay 16 A, 1 x Relay 6 A)
LIOB-454	LIOB-IP852 I/O Module: 7 UI, 4 AO, 7 DO (5 x Relay 6 A, 2 x Triac 0.5 A), 1 Pressure Sensor
LIOB-550	LIOB-BIP I/O Module: 8 UI, 2 DI, 2 AO, 8 DO (4 x Relay 6 A, 4 x Triac 0.5 A)
LIOB-551	LIOB-BIP I/O Module: 8 UI, 12 DI
LIOB-552	LIOB-BIP I/O Module: 6 UI, 6 AO, 8 DO (8 x Relay 6 A)
LIOB-553	LIOB-BIP I/O Module: 6 UI, 6 AO, 5 DO (4 x Relay 16 A, 1 x Relay 6 A)
LIOB-554	LIOB-BIP I/O Module: 7 UI, 4 AO, 7 DO (5 x Relay 6 A, 2 x Triac 0.5 A), 1 Pressure Sensor
LPOW-2415A	LIOB-Connect power supply unit, 24 VDC, 15 W
LPOW-2415B	Power supply unit with power connector 24 VDC, 15 W
L-MBUS20	M-Bus Level Converter, Interface for up to 20 M-Bus devices
L-MBUS80	M-Bus Level Converter, Interface for up to 80 M-Bus devices
LKNX-300	KNX interface to connect KNX TP1 devices
LENO-800	EnOcean Interface 868 MHz Europe
LENO-801	EnOcean Interface 902 MHz USA/Canada
LENO-802	EnOcean Interface 928 MHz Japan
LWLAN-800	Wireless LAN Interface IEEE 802.11bgn
LMPBUS-804	MP-Bus interface for 16 devices per channel, up to 4 channels
LSMI-800	Standard Motor Interface for 16 motors via EXT port
LSMI-804	Standard Motor Interface for 64 motors, 4 SMI channels via USB
LTE-800	LTE Interface
LRS232-802	USB to 2 x RS-232 Interface

L-INX Automation Server

LINX-215

Datasheet #89047423



- ✓ BACnet
- ✓ Modbus
- ✓ CEA-709
- ✓ M-Bus
- ✓ KNX
- ✓ OPC

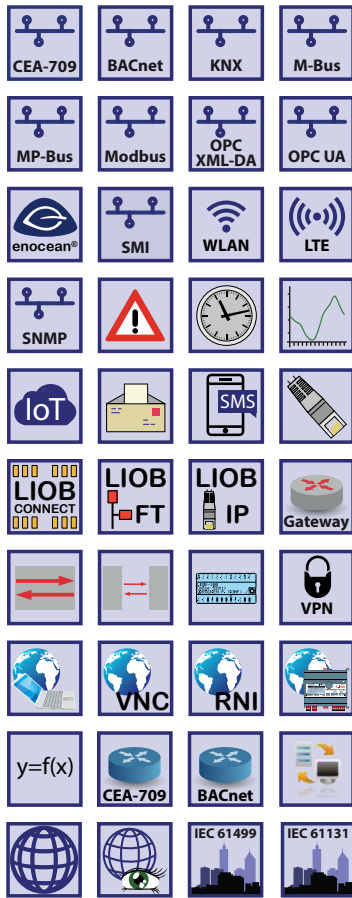

The L-INX Automation Servers LINX-215 are programmable automation stations with integrated graphical visualization for central automation tasks in BACnet networks, which can be programmed by L-STUDIO. They can integrate physical I/Os through L-IOB I/O Modules via LIOB-Connect, LIOB-FT, or LIOB-IP. Local operation and override is provided by the built-in jog dial and the backlit display (128x64 pixels). Device and data point information is shown on the display via symbols and in text format.

LonMark Systems can be integrated via IP-852 (Ethernet/IP) or TP/FT-10. In addition, the Automation Servers provides connectivity to concurrently integrate KNX, Modbus, and M-Bus and connect as a gateway data points of different technological origin. The Automaton Servers feature an integrated IP-852 router providing the complete feature set of corresponding L-IP devices.

BACnet can be integrated via BACnet/IP, BACnet/SC or BACnet MS/TP. In addition, the Automation Servers provide connectivity to concurrently integrate KNX, Modbus, and M-Bus and connect as a gateway data points of different technological origin. Optionally, mathematical objects can be applied within a connection to calculate the data point output values depending on the formula used. The Automation Servers feature a BACnet/SC router, BACnet/IP router including BBMD as well as Slave-Proxy functionality. LINX-215 is BTL certified as B-BC (BACnet Building Controller).

The gateway functionality allows data communication between all communication technologies available on the device. Different technology data points are mapped through Local Connections on the device. The mapping of different technology data points on distributed devices is supported by Global Connections. L-INX Automation Servers also support Smart Auto-Connect™ – the automatic generation of connections to substantially reduce engineering efforts and cost. All technology data points are automatically created as OPC XML-DA and OPC UA data points.

Each L-INX Automation Server is equipped with two Ethernet ports. It can either be configured to use the internal switch to interconnect the two ports or every port is configured to work in a separate IP network.

When the Ethernet ports are configured for two separate IP networks, one port can be connected for instance to a WAN (Wide Area Network) with enabled network security (HTTPS) while the second port can be configured to be connected to an insecure network (LAN) where the standard building automation protocols like BACnet/IP, LON/IP, or Modbus TCP are present. These devices also feature fire-wall functionality of course to isolate particular protocols or services between the ports. The built-in VPN function provides for simple VPN setup and secure access to remote sites. The LTE-800 interface enables wireless access to remote sites through a mobile carrier.

Using the internal switch, a daisy chained line topology of up to 20 devices can be built, which reduces costs for network installation. The IP switch also allows the setup of a redundant Ethernet installation (ring topology), which increases reliability. The redundant Ethernet topology is enabled by the Rapid Spanning Tree Protocol (RSTP), which is supported by most managed switches.

The L-INX devices provide fully featured AST™ functionality (Alarming, Scheduling, and Trending) and can be integrated perfectly into the L-WEB System.

IoT Integration

The IoT function (Node.js) allows connecting the system to almost any cloud service, either for uploading historical data to analytics services, telemetry using MQTT, delivering alarm messages to alarm processing services or operating parts of the control system over a cloud service (e.g., scheduling based on Web calendars or booking systems). Processing Internet information such as weather data in forecast-based control is also possible. Finally, the JavaScript kernel also allows implementing serial protocols to non-standard equipment in primary plant control.

Features

- Programmable with L-STUDIO IEC 61131-3 and IEC 61499
- Room controller for up to 8 room segments
- Extension with physical inputs and outputs using L-IOB I/O Modules (LIOB-10x/11x, LIOB-15x, LIOB-45x and LIOB-55x)
- 128x64 graphic display with backlight
- Local and remote access to information about device status and data points
- Manual operation using the jog dial or VNC client
- Alarming, Scheduling, and Trending (AST™)
- Node.js support for easy IoT integration (e.g. Google calendar, MQTT, Alexa & friends, multimedia equipment,...)
- Event-driven e-mail notification
- Math objects to execute mathematical operations on data points
- Stores customized graphical pages
- Visualization of customized graphical pages through LWEB-900 (Building Management), LWEB-803 (Monitoring and Control), or LWEB-802 (Web Browser)
- Built-in OPC XML-DA and OPC UA server
- Dual Ethernet/IP interface
- Access to network statistics
- Compliant with ANSI/ASHRAE 135-2012 and ISO 16484-5:2012 standard
- Supports BACnet MS/TP, BACnet/IP and BACnet/SC
- BACnet Client Function (Write Property, Read Property, COV Subscription)
- BACnet Client Configuration with configuration tool (scan and EDE import)
- B-BC (BACnet Building Controller) functionality, BTL certified
- Integrated BACnet/IP to BACnet/SC and BACnet MS/TP Router including BBMD as well as Slave-Proxy functionality
- Compliant with CEA-709, CEA-852, and ISO/IEC 14908 Standard (LonMark System)
- Support TP/FT-10 or IP-852 (Ethernet/IP)
- Support of dynamically created or static NVs
- Support of user-defined NVs (UNVTs) and Configuration Properties (SCPTs, UCPTs)
- Remote Network Interface (RNI) with 2 MNI devices
- Integrated IP-852 to TP/FT-10 Router
- KNXnet/IP, connection to KNX TP1 through LKNX-300 Interface
- M-Bus Master according to EN 13757-3, connection via optional M-Bus Converter (L-MBUS20 or L-MBUS80)
- Modbus TCP and Modbus RTU/ASCII (Master or Slave)
- Gateway functions including Smart Auto-Connect™
- Integrated web server for device configuration and monitoring data points
- Configurable via Ethernet/IP or TP/FT-10
- Connection to EnOcean wireless devices via LENO-80x Interface
- Supports SMI (Standard Motor Interface) through LSMI-800
- Supports WLAN through LWLAN-800 Interface
- Supports MP-Bus through LMPBUS-804 Interface
- Supports LTE through LTE-800 Interface
- Supports RS-232 through LRS232-802 Interface
- Stores user-defined project documentation

Specifications

Dimensions (mm)	107 x 100 x 75 (L x W x H), DIM045	
Installation	DIN rail mounting following DIN 43880, top hat rail EN 50022	
Power supply	24 VDC / 24 V AC ±10 %, typ. 2.5 W	
Operating conditions	0 °C to 50 °C, 10–90 % RH, noncondensing, degree of protection: IP40, IP20 (terminals)	
Interfaces	2 x Ethernet (100Base-T): OPC XML-DA, OPC UA, LonMark IP-852, BACnet/IP, BACnet/SC LIOB-IP, KNXnet/IP, Modbus TCP (Master or Slave), HTTP, FTP, SSH, HTTPS, Firewall, VNC, SNMP 1 x LIOB-Connect 1 x RS-485 (ANSI TIA/EIA-485): BACnet MS/TP or Modbus RTU/ASCII (Master or Slave) 1 x FT	1 x EXT: M-Bus, Master EN 13757-3 (needs L-MBUS20 or L-MBUS80) or KNX TP1 (needs LKNX-300) or SMI (needs LSMI-800) 2 x USB-A: WLAN (needs LWLAN-800), EnOcean (needs LENO-80x), SMI (needs LSMI-804), LTE (needs LTE-800), MP-Bus (needs LMPBUS-804) RS-232 (needs LRS232-802)
L-IOB I/O Modules	Up to 8 L-IOB I/O Modules in any combination of type LIOB-10x/11x, LIOB-15x, LIOB-45x and LIOB-55x	
BACnet/IP Router	1	
CEA-709 Router	1	
Remote Network Interface	1 RNI with 2 MNI devices	
Program cycle time	Down to 10 ms	
Max. number of Rooms/Segments	8	

Runtime licenses

Type	LINX-215
Programming, Tools	L-STUDIO (IEC 61131-3 and IEC 61499 based), L-INX Configurator
License	L-STUDIO: included

LINX-215

Resource limits			
Total number of data points	10 000	Address table entries	1 000 (non-ECS mode: 15)
OPC data points	5 000	LonMark Calendars	1 (25 calendar patterns)
BACnet objects	750 (analog, binary, multi-state)	LonMark Schedulers	100
BACnet client mappings	750	LonMark Alarm Servers	1
BACnet calendar objects	25	Total trended data points	256
BACnet scheduler objects	100 (64 data points per object)	E-mail templates	100
BACnet notification classes	32	Math objects	100
Trend logs (BACnet or generic)	256 (13 000 000 entries, ≈ 200 MB)	Alarm logs	10
Network variables (NVs)	1 000	M-Bus data points	1 000
Alias NVs	1 000	Modbus data points	2 000
External NVs (polling)	1 000	MP-Bus devices (per channel)	16
KNXnet/IP com-objects	250	KNX TP1 com-objects	250
Connections (Local / Global)	1 000 / 250	L-IOB I/O Modules	8
Number of L-WEB clients	32 (simultaneously)	Number of EnOcean devices	25
SMI devices (per channel)	16	EnOcean data points	250
Order number	Product description		
LINX-215	BACnet Automation Server, B-BC, L-STUDIO programmable, built-in BACnet/IP and BACnet/SC to MS/TP Router, CEA-709 Automation Server, built-in IP-852 Router		
L-STUDIO	Development and integration platform for programmable LOYTEC controllers		
LIOB-100	LIOB-Connect I/O Module: 8 UI, 2 DI, 2 AO, 9 DO (5 x Relay 6 A, 4 x Triac 0.5 A)		
LIOB-101	LIOB-Connect I/O Module: 8 UI, 16 DI		
LIOB-102	LIOB-Connect I/O Module: 6 UI, 6 AO, 8 DO (8 x Relay 6 A)		
LIOB-103	LIOB-Connect I/O Module: 6 UI, 6 AO, 5 DO (5 x Relay 16 A)		
LIOB-110	LIOB-Connect I/O Module: 20 Universal I/O (IO)		
LIOB-112	LIOB-Connect I/O Module: 40 Universal I/O (12 optionally with 4-20 mA Current Output)		
LIOB-150	LIOB-FT I/O Module: 8 UI, 2 DI, 2 AO, 8 DO (4 x Relay 6 A, 4 x Triac 0.5 A)		
LIOB-151	LIOB-FT I/O Module: 8 UI, 12 DI		
LIOB-152	LIOB-FT I/O Module: 6 UI, 6 AO, 8 DO (8 x Relay 6 A)		
LIOB-153	LIOB-FT I/O Module: 6 UI, 6 AO, 5 DO (4 x Relay 16 A, 1 x Relay 6 A)		
LIOB-154	LIOB-FT I/O Module: 7 UI, 4 AO, 7 DO (5 x Relay 6 A, 2 x Triac 0.5 A), 1 Pressure Sensor		
LIOB-550	LIOB-BIP I/O Module: 8 UI, 2 DI, 2 AO, 8 DO (4 x Relay 6 A, 4 x Triac 0.5 A)		
LIOB-551	LIOB-BIP I/O Module: 8 UI, 12 DI		
LIOB-552	LIOB-BIP I/O Module: 6 UI, 6 AO, 8 DO (8 x Relay 6 A)		
LIOB-553	LIOB-BIP I/O Module: 6 UI, 6 AO, 5 DO (4 x Relay 16 A, 1 x Relay 6 A)		
LIOB-554	LIOB-BIP I/O Module: 7 UI, 4 AO, 7 DO (5 x Relay 6 A, 2 x Triac 0.5 A), 1 Pressure Sensor		
LPOW-2415A	LIOB-Connect power supply unit, 24 VDC, 15 W		
LPOW-2415B	Power supply unit with power connector 24 VDC, 15 W		
L-MBUS20	M-Bus Level Converter, Interface for up to 20 M-Bus devices		
L-MBUS80	M-Bus Level Converter, Interface for up to 80 M-Bus devices		
LKNX-300	KNX interface to connect KNX TP1 devices		
LENO-800	EnOcean Interface 868 MHz Europe		
LENO-801	EnOcean Interface 902 MHz USA/Canada		
LENO-802	EnOcean Interface 928 MHz Japan		
LWLAN-800	Wireless LAN Interface IEEE 802.11bgn		
LMPBUS-804	MP-Bus interface for 16 devices per channel, up to 4 channels		
LSMI-800	Standard Motor Interface for 16 motors via EXT port		
LSMI-804	Standard Motor Interface for 64 motors, 4 SMI channels via USB		
LTE-800	LTE Interface		
LRS232-802	USB to 2 x RS-232 Interface		

L-IOB I/O Controllers & Modules



L-IOB I/O Controllers

The L-IOB I/O Controller family of products consists of programmable controllers featuring various I/O configurations. Based on the new powerful LOYTEC's A64 (64-bit architecture) quad-core CPU platform, the L-IOB I/O Controllers provide first class performance for a wide area of applications.

Programmable

The built-in PLC functionality makes the L-IOB I/O Controllers a good fit for various control applications in building automation. Like the L-INX Automation Servers, the L-IOB I/O Controllers can be programmed with L-STUDIO in IEC 61131-3 or IEC 61499. The same application libraries and application programs can be used on L-INX or L-IOB Controller devices. For details please check the L-STUDIO section (page 32).

LonMark Models

LIOB-585/586/588/589 and LIOB-59x communicate in the LonMark system via network variables over TP/FT-10 or Ethernet/IP-852. They come with a freely configurable network variable interface and offer up to 256 address table entries.

BACnet/IP Models

The LIOB-58x/59x I/O Controllers adhere to the BACnet Building Controller Profile (B-BC) and communicate over Ethernet/IP in the BACnet/IP network. The I/O data points can either be exposed through BACnet server objects or actively fetched from a BACnet server via BACnet client maps on the L-IOB I/O Controllers.

L-IOB I/O Controllers

L-IOB I/O Controllers – IEC 61131-3 / IEC 61499 programmable

BACnet/IP and LonMark IP-852

LIOB-585

6 UI
2 AO
5 DO
PRESS

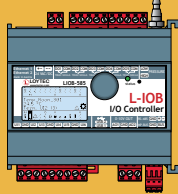

LIOB-586

6 UI
4 DI
6 DO

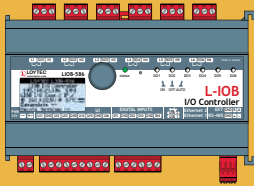

LIOB-587

6 UI
4 DI
6 DO

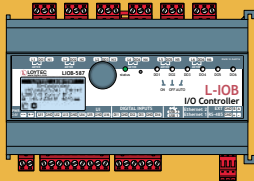

LIOB-588

10 UI
6 AO
8 DO

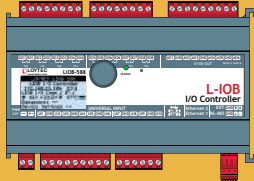

LIOB-589

10 UI
6 DI
6 AO
4 DO

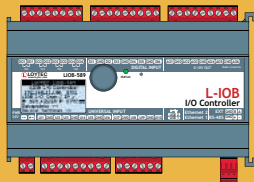

BACnet/IP and LonMark IP-852

LIOB-590

20 IO



LIOB-592

40 IO

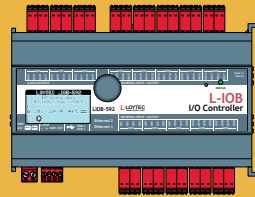

LIOB-593

16 IO
7 DO

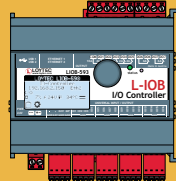

LIOB-594

8 IO
7 DO



LIOB-595

8 IO
4 DO
PRESS

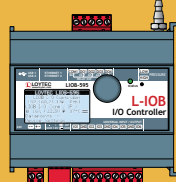

LIOB-596

8 IO
4 DO

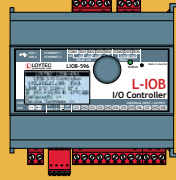

BACnet/IP and DALI

LIOB-591 Room Controller

8 IO (U,I,R)
12 IO (U)

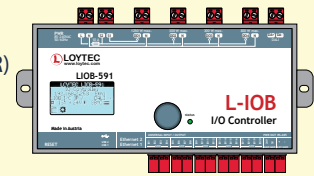

U: 0-10V input or 0-10V output
I: 4-20 mA input
R: resistance measurement

L-IOB I/O Controller

LIOB-585

Datasheet #89056924



- ✓ BACnet
- ✓ Modbus
- ✓ CEA-709
- ✓ MP-Bus
- KNX
- ✓ OPC



LIOB-585 I/O Controllers are IP-enabled, compact, programmable automation stations for LonMark Systems and BACnet/IP and BACnet/SC networks with physical inputs and outputs and integrated graphical visualization.

Communication

The LIOB-585 I/O Controller is equipped with two Ethernet ports including a built-in Ethernet switch. This allows for building a daisy chained line topology of up to 20 devices, which reduces costs for network installation. Dual Ethernet port devices also allow the setup of a redundant Ethernet installation (ring topology), which increases reliability. The redundant Ethernet topology is enabled by the Rapid Spanning Tree Protocol (RSTP), which is supported by most managed switches.

Technology data points are automatically exposed as OPC tags for higher level OPC client applications or L-WEB system via the integrated OPC server providing TSL encrypted web services (OPC XML-DA) or UA Secure Conversation (OPC UA). The L-IOB I/O Controllers further allow data exchange over global connections (network-wide data exchange), offer AST™ functions (Alarming, Scheduling, and Trending), store custom graphic pages for visualization in LWEB-802/803, and can be seamlessly integrated in the LWEB-900 Building Management System. LIOB-585 I/O Controllers implement the BACnet Building Controller (B-BC) profile and are BTL certified.

IoT Integration

The IoT function (Node.js) allows connecting the system to almost any cloud service, either for uploading historical data to analytics services, telemetry using MQTT, delivering alarm messages to alarm processing services or operating parts of the control system over a cloud service (e.g., scheduling based on Web calendars or booking systems). Processing Internet information such as weather data in forecast-based control is also possible. Finally, the JavaScript kernel also allows implementing serial protocols to non-standard equipment in primary plant control.

Local Operation and Override

All L-IOB I/O Controllers are equipped with an LCD display (128x64) with backlight and jog dial for manual local operation and override. Device and data point information is displayed in text form and via graphical symbols.

Unitary and Terminal Controller

The LIOB-585 is designed to efficiently implement unitary and terminal applications in a compact form factor. The integrated differential pressure sensor, its local I/O, and the built-in MP-Bus port provide connectivity for all unitary and terminal equipment. In addition, the RS-485 port allows connection of L-STAT room operator panels for temperature and air quality measurement and user interaction.

Features

- Automation station with physical inputs and outputs
- Math objects to execute mathematical operations on data points
- Programmable with L-STUDIO IEC 61131-3 and IEC 61499
- Stores customized graphical pages
- Room controller for up to 2 room segments
- Visualization of customized graphical pages through LWEB-900 (Building Management), LWEB-803 (Monitoring and Control), or LWEB-802 (Web Browser)
- 128x64 graphic display with backlight
- Support of the L-STAT Room Operator Panel
- Local and remote access to information about device status and data points
- Built-in OPC XML-DA and OPC UA server
- Manual operation using the jog dial or VNC client
- Dual Ethernet/IP interface
- Alarming, Scheduling, and Trending (AST™)
- Access to network statistics
- Node.js support¹ for easy IoT integration (e.g. Google calendar, MQTT, Alexa & friends, multimedia equipment,...)
- Compliant with ANSI/ASHRAE 135-2012 and ISO 16484-5:2012 standard
- Event-driven e-mail notification

¹requires L-IOT1 software license

- Supports BACnet MS/TP, BACnet/IP and BACnet/SC
- BACnet Client Function (Write Property, Read Property, COV Subscription)
- BACnet Client Configuration with configuration tool (scan and EDE import)
- B-BC (BACnet Building Controller) functionality, BTL certified
- Compliant with CEA-709, CEA-852, and ISO/IEC 14908 Standard (LonMark System)
- Supports IP-852 (Ethernet/ IP)
- Support of dynamically created or static NVs
- Support of user-defined NVs (UNVTs) and Configuration Properties (SCPTs, UCPTs)
- Integrated BACnet/IP to BACnet/SC and BACnet MS/ TP Router including BBMD as well as Slave-Proxy functionality
- Gateway functions including Smart Auto-Connect™
- Integrated web server for device configuration and monitoring data points
- Connection to EnOcean wireless devices via LENO-80x Interface
- Supports WLAN through LWLAN-800 Interface
- Supports LTE through LTE-800 Interface
- Stores user-defined project documentation
- Integration of damper actuator via MP-Bus
- Differential pressure sensor

General Specifications

Dimensions (mm)	107 x 100 x 75 (L x W x H), DIM057	
Installation	DIN rail mounting following DIN 43880, top hat rail EN 50022	
Purpose of control	Operating control	
Construction of control	Independently mounted control	
Feature of automatic action	Type 1	
Operating conditions	0 °C to 50 °C, 10–90 % RH, noncondensing, degree of protection: IP40, IP20 (terminals), pollution degree 2	
Power supply	24 V DC/ VAC SELV ±10 % via LPOW-2415B, or with an external power supply	
Rated Impulse Voltage	2500 V	
Program cycle time	Down to 10 ms	
Interface	2 x Ethernet (100Base-T): Web services (OPC XML-DA, OPC UA), LonMark IP-852, BACnet/IP*, BACnet/SC*, Modbus TCP (Master or Slave), HTTP, FTP, SSH, HTTPS, Firewall, VNC, SNMP 2 x USB-A: WLAN (needs LWLAN-800), EnOcean (needs LENO-80x), LTE (needs LTE-800)	1 x RS-485 (ANSI TIA/EIA-485): BACnet MS/TP* or Modbus RTU/ASCII (Master or Slave) or L-STAT Room Operator Panels 1 x MP-Bus
	* Router between BACnet/IP, BACnet/SC and BACnet MS/TP	
Max. number of Rooms/Segments	2	

Specifications

Type	LIOB-585
Power consumption	4.5 W
Universal Input (UI)	6
Digital Input (DI)	-
Analog Output (AO)	2
Digital Output (DO)	5 (5 x Triac 0.5 A)
Digital Output specification	Please refer to the " General Input and Output Specification of LOYTEC devices " at the end of the L-IOB section for more details.
Differential Pressure Sensor	±500 Pa (14 Bit)

LIOB-585

Resource limits			
Total number of data points	10 000	LonMark Calendars	1 (25 calendar patterns)
OPC data points	5 000	LonMark Schedulers	10
BACnet objects	500 (analog, binary, multi-state)	LonMark Alarm Servers	1
BACnet client mappings	500	E-mail templates	50
BACnet calendar objects	25	Math objects	50
BACnet scheduler objects	10 (64 data points per object)	Alarm logs	10
BACnet notification classes	32	Modbus data points	300
Trend logs (BACnet or generic)	256 (13 000 000 entries, ≈ 200 MB)	Connections (Local / Global)	500 / 100
Total trended data points	256	Number of L-WEB clients	32 (simultaneously)
CEA-709 network variables (NVs)	500	L-STAT Room Operator Panels	8
CEA-709 Alias NVs	500	EnOcean devices	10
CEA-709 External NVs (polling)	500	EnOcean data points	100
CEA-709 address table entries	256 (non-ECS mode: 15)	MP-Bus devices (per channel)	8 (16 MPL)
Runtime licenses			
Type	LIOB-585		
Programming, Tools	L-STUDIO software (IEC 61131-3 or IEC 61499), L-INX Configurator		
License	L-STUDIO: included		
Order number	Product description		
LIOB-585	L-IOB I/O Controller: 6 UI, 2 AO, 5 DO (5 x Triac 0.5 A), 1 Pressure Sensor		
L-STUDIO	Development and integration platform for programmable LOYTEC controllers		
L-ACT101-MP	Actuator 5/8", 5 Nm, 45in-lb, MP-Bus cable		
L-ACT102-MP	Actuator 3/4", 5 Nm, 45in-lb, MP-Bus cable		
L-ACT-FRAME1	Mounting frame		
LPOW-2415B	Power supply unit with power connector 24 VDC, 15 W		
L-IOT1	Add-on Software License to enable IoT functionality on LIOB-585/586/587/588/589/59x, LIOB-AIR, and LINX-102/103/202/203		
L-TEMP2	External temperature sensor (NTC10K) for use with L-IOB Universal Inputs		
LENO-800	EnOcean Interface 868 MHz Europe		
LENO-801	EnOcean Interface 902 MHz USA/Canada		
LENO-802	EnOcean Interface 928 MHz Japan		
LWLAN-800	Wireless LAN Interface IEEE 802.11bgn		
LTE-800	LTE Interface		
LSTAT-800-G3-Lx	Room Operator Panel, black front, white enclosure, Modbus, temperature, rel. humidity, ext. switch/NTC, IR receiver, Buttons (Lx)		
LSTAT-801-G3-Lx	Room Operator Panel, front black, white enclosure, Modbus, temperature, rel. humidity, ext. switch/NTC, occupancy, IR receiver, Buttons (Lx)		
LSTAT-802-G3-Lx	Room Operator Panel, front black, white enclosure, Modbus, temperature, rel. humidity, ext. switch/NTC, occupancy, IR receiver, CO2, Buttons (Lx)		
LSTAT-800-G3-L20x	Room Operator Panel, white front, white enclosure, Modbus, temperature, rel. humidity, ext. switch/NTC, IR receiver, Buttons (Lx)		
LSTAT-801-G3-L20x	Room Operator Panel, white front, white enclosure, Modbus, temperature, rel. humidity, ext. switch/NTC, occupancy, IR receiver, Buttons (Lx)		
LSTAT-802-G3-L20x	Room Operator Panel, white front, white enclosure, Modbus, temperature, rel. humidity, ext. switch/NTC, occupancy, IR receiver, CO2, Buttons (Lx)		
LSTAT-80x-CUSTOM	One-time customization cost for L-STAT custom design, including 2 working samples		

- ✓ BACnet
- ✓ CEA-709
- KNX

- ✓ Modbus
- ✓ M-Bus
- ✓ OPC



Datasheet #89046124



LIOB-586/587/588/589 I/O Controllers are IP-enabled, compact, programmable BACnet Building Controller (B-BC) with physical inputs and outputs and integrated graphical visualization.

Communication

The LIOB-586/587/588/589 I/O Controllers are equipped with two Ethernet ports including a built-in Ethernet switch. This allows for building a daisy chained line topology of up to 20 devices, which reduces costs for network installation. Dual Ethernet port devices also allow the setup of a redundant Ethernet installation (ring topology), which increases reliability. The redundant Ethernet topology is enabled by the Rapid Spanning Tree Protocol (RSTP), which is supported by most managed switches.

Technology data points are automatically exposed as OPC tags for higher level OPC client applications or L-WEB system via the integrated OPC server providing TSL encrypted web services (OPC XML-DA) or UA Secure Conversation (OPC UA). The L-IOB I/O Controllers further allow data exchange over global connections (network-wide data exchange), offer AST™ functions (Alarming, Scheduling, and Trending), store custom graphic pages for visualization in LWEB-802/803, and can be seamlessly integrated in the LWEB-900 Building Management System. LIOB-586/587/588/589 I/O Controllers implement the BACnet Building Controller (B-BC) profile and are BTL certified.

IoT Integration

The IoT function (Node.js) allows connecting the system to almost any cloud service, either for uploading historical data to analytics services, telemetry using MQTT, delivering alarm messages to alarm processing services or operating parts of the control system over a cloud service (e.g., scheduling based on Web calendars or booking systems). Processing Internet information such as weather data in forecast-based control is also possible. Finally, the JavaScript kernel also allows implementing serial protocols to non-standard equipment in primary plant control.

Local Operation and Override

All L-IOB I/O Controllers are equipped with an LCD display (128x64) with backlight and jog dial for manual local operation and override. Device and data point information is displayed in text form and via graphical symbols. On the LIOB-586/ LIOB-587 front panel the six relay outputs can be overridden via 3-way switches.

Power measurement

External meters can be integrated via M-Bus or Modbus. The LIOB-586/587/588/589 I/O Controllers perfectly meet energy management and energy reporting applications. The LIOB-587 includes built-in power measurement.

Features

- Automation station with physical inputs and outputs
- Programmable with L-STUDIO IEC 61131-3 and IEC 61499
- Room controller for up to 2 room segments
- Extension with physical inputs and outputs using one L-IOB I/O Module (LIOB-10x/11x or LIOB-45x/55x)
- 128x64 graphic display with backlight
- Local and remote access to information about device status and data points
- Manual operation using the jog dial or VNC client
- Manual override of each output through switches (only LIOB-586, LIOB-587)
- Alarming, Scheduling, and Trending (AST™)
- Node.js support¹ for easy IoT integration (e.g. Google calendar, MQTT, Alexa & friends, multimedia equipment,...)
- Event-driven e-mail notification
- Math objects to execute mathematical operations on data points
- Stores customized graphic pages
- Visualization of customized graphic pages through LWEB-900 (Building Management), LWEB-803 (Monitoring and Control), or LWEB-802 (Web Browser)
- Support of the L-STAT Room Operator Panel
- Built-in OPC XML-DA and OPC UA server
- Dual Ethernet/IP interface

¹ requires L-IOT1 software license

L-IOB I/O Controller

LIOB-586/587/588/589

- Access to network statistics
- Compliant with ANSI/ASHRAE 135-2012 and ISO 16484-5:2012 standard
- Supports BACnet MS/TP, BACnet/IP and BACnet/SC
- BACnet Client Function (Write Property, Read Property, COV Subscription)
- BACnet Client Configuration with configuration tool (scan and EDE import)
- B-BC (BACnet Building Controller) functionality, BTL certified
- Compliant with CEA-709, CEA-852, and ISO/IEC 14908 Standard (LonMark System)
- Supports IP-852 (Ethernet/IP)
- Support of dynamically created or static NVs
- Support of user-defined NVs (UNVTs) and Configuration Properties (SCPTs, UCPTs)
- Integrated BACnet/IP to BACnet/SC and BACnet MS/TP Router including BBMD as well as Slave-Proxy functionality
- M-Bus Master according to EN 13757-3, connection via optional M-Bus Converter (L-MBUS20 or L-MBUS80)
- Gateway functions including Smart Auto-Connect™
- Modbus TCP and Modbus RTU (Master or Slave)
- Integrated web server for device configuration and monitoring data points
- Connection to EnOcean wireless devices via LENO-80x Interface
- Supports WLAN through LWLAN-800 Interface
- Supports MP-Bus through LMPBUS-804 Interface
- Supports LTE through LTE-800 Interface
- Supports RS-232 through LRS232-802 Interface
- Stores user-defined project documentation
- Support VPN

General Specifications

Type	LIOB-586	LIOB-587	LIOB-588	LIOB-589
Dimensions (mm)	159 x 100 x 75 (L x W x H), DIM005		159 x 100 x 75 (L x W x H), DIM006	159 x 100 x 75 (L x W x H), DIM007
Installation	DIN rail mounting following DIN 43880, top hat rail EN 50022			
Purpose of control	Operating control			
Construction of control	Independently mounted control			
Feature of automatic action	Type 1			
Operating conditions	0 °C to 50 °C, 10 – 90 % RH, noncondensing, degree of protection: IP40, IP20 (terminals), pollution degree 2			
Power supply	24 VDC / VAC SELV ±10 % via L-POW, or with an external power supply			
Rated Impulse Voltage	2500 V			
Program cycle time	Down to 10 ms, and event-triggered			
L-IOB I/O Module	1 L-IOB I/O Module of type LIOB-10x/11x or LIOB-45x/55x			
Interface	2 x Ethernet (100Base-T): Web services (OPC XML-DA, OPC UA), LonMark IP-852, BACnet/IP*, BACnet/SC*, LIOB-IP, Modbus TCP (Master or Slave), HTTP, FTP, SSH, HTTPS, Firewall, VNC, SNMP, VPN 1 x LIOB-Connect 2 x USB-A: WLAN (needs LWLAN-800), EnOcean (needs LENO-80x), MP-Bus (needs LMPBUS-804), LTE (needs LTE-800) 1 x EXT: M-Bus, Master EN 13757-3 (needs L-MBUS20 or L-MBUS80) 1 x RS-485 (ANSI TIA/ EIA-485): BACnet MS/ TP*, or Modbus RTU (Master or Slave), or L-STAT Room Operator Panels * Router between BACnet/IP, BACnet/SC and BACnet MS/TP			
Max. number of Rooms/Segments	2	2	2	2

Specifications L-IOB I/O Controller (LIOB-58x)

Type	LIOB-586	LIOB-587	LIOB-588	LIOB-589
Power consumption	5.4 W (Relays on)	5.4 W (Relays on)	5.9 W (Relays on)	4.5 W (Relays on)
Universal Input (UI)	6	6	10	10
Digital Input (DI)	4	4	-	6
Analog Output (AO)	-	-	6	6
Digital Output (DO)	6 (6 x Relay 10 A Type2)	6 (6 x Relay 10 A Type2)	8 (8 x Relay 6 A)	4 (4 x Relay 6 A)
Digital Output specification	Please refer to the " General Input and Output Specification of LOYTEC devices " for more details.			

Runtime licenses				
Type	LIOB-586	LIOB-587	LIOB-588	LIOB-589
Programming, Tools	L-STUDIO (IEC 61131-3 and IEC 61499 based), L-INX Configurator			
License	L-STUDIO: included	L-STUDIO: included	L-STUDIO: included	L-STUDIO: included
Resource limits				
Total number of data points	10 000	LonMark Schedulers	10	
OPC data points	1 000	LonMark Alarm Servers	1	
BACnet objects	500 (analog, binary, multi-state)	E-mail templates	50	
BACnet client mappings	500	Math objects	50	
BACnet calendar objects	25	Alarm logs	10	
BACnet scheduler objects	10 (64 data points per object)	M-Bus data points	300	
BACnet notification classes	32	Modbus data points	300	
Trend logs (BACnet or generic)	256 (13 000 000 entries, ≈ 200 MB)	Connections (Local / Global)	500 / 100	
Total trended data points	256	Number of L-WEB clients	32 (simultaneously)	
CEA-709 network variables (NVs)	500	L-IOB I/O Modules	1	
CEA-709 Alias NVs	500	L-STAT Room Operator Panels	8	
CEA-709 External NVs (polling)	500	EnOcean devices	10	
CEA-709 address table entries	256 (non-ECS mode: 15)	EnOcean data points	100	
LonMark Calendars	1 (25 calendar patterns)	MP-Bus devices (per channel)	8 (16 MPL)	
Order number	Product description			
LIOB-586	L-IOB I/O Controller: 6 UI, 4 DI, 6 DO (6 x Relay 10 A Type2)			
LIOB-587	L-IOB I/O Controller: 6 UI, 4 DI, 6 DO (6 x Relay 10 A Type2) with power measurement			
LIOB-588	L-IOB I/O Controller: 10 UI, 6 AO, 8 DO (8 x Relay 6 A)			
LIOB-589	L-IOB I/O Controller: 10 UI, 6 AO, 6 DI, 4 DO (4 x Relay 6 A)			
LIOB-100	LIOB-Connect I/O Module: 8 UI, 2 DI, 2 AO, 9 DO (5 x Relay 6 A, 4 x Triac 0.5 A)			
LIOB-101	LIOB-Connect I/O Module: 8 UI, 16 DI			
LIOB-102	LIOB-Connect I/O Module: 6 UI, 6 AO, 8 DO (8 x Relay 6 A)			
LIOB-103	LIOB-Connect I/O Module: 6 UI, 6 AO, 5 DO (5 x Relay 16 A)			
LIOB-110	LIOB-Connect I/O Module: 20 Universal I/O (IO)			
LIOB-112	LIOB-Connect I/O Module: 40 Universal I/O (12 optionally with 4-20 mA Current Output)			
LIOB-450	LIOB-IP852 I/O Module: 8 UI, 2 DI, 2 AO, 8 DO (4 x Relay 6 A, 4 x Triac 0.5 A)			
LIOB-451	LIOB-IP852 I/O Module: 8 UI, 12 DI			
LIOB-452	LIOB-IP852 I/O Module: 6 UI, 6 AO, 8 DO (8 x Relay 6 A)			
LIOB-453	LIOB-IP852 I/O Module: 6 UI, 6 AO, 5 DO (4 x Relay 16 A, 1 x Relay 6 A)			
LIOB-454	LIOB-IP852 I/O Module: 7 UI, 4 AO, 7 DO (5 x Relay 6 A, 2 x Triac 0.5 A), 1 Pressure Sensor			
LIOB-550	LIOB-BIP I/O Module: 8 UI, 2 DI, 2 AO, 8 DO (4 x Relay 6 A, 4 x Triac 0.5 A)			
LIOB-551	LIOB-BIP I/O Module: 8 UI, 12 DI			
LIOB-552	LIOB-BIP I/O Module: 6 UI, 6 AO, 8 DO (8 x Relay 6 A)			
LIOB-553	LIOB-BIP I/O Module: 6 UI, 6 AO, 5 DO (4 x Relay 16 A, 1 x Relay 6 A)			
LIOB-554	LIOB-BIP I/O Module: 7 UI, 4 AO, 7 DO (5 x Relay 6 A, 2 x Triac 0.5 A), 1 Pressure Sensor			
L-STUDIO	Development and integration platform for programmable LOYTEC controllers			
L-IOT1	Add-on Software License to enable IoT functionality on LIOB-585/586/587/588/589/59x, LIOB-AIR, and LINX-102/103/202/203			
LPOW-2415A	LIOB-Connect power supply unit, 24 VDC, 15 W			
LPOW-2415B	Power supply unit with power connector 24 VDC, 15 W			
L-TEMP2	External temperature sensor (NTC10K) for use with L-IOB Universal Inputs			
LENO-800	EnOcean Interface 868 MHz Europe			
LENO-801	EnOcean Interface 902 MHz USA/Canada			
LENO-802	EnOcean Interface 928 MHz Japan			
LWLAN-800	Wireless LAN Interface IEEE 802.11bgn			
LTE-800	LTE Interface			
LRS232-802	USB to 2 x RS-232 Interface			

L-IOB I/O Controller

LIOB-586/587/588/589

Order number	Product description
LMPBUS-804	MP-Bus interface for 16 devices per channel, up to 4 channels
L-MBUS20	M-Bus Level Converter, Interface for up to 20 M-Bus devices
L-MBUS80	M-Bus Level Converter, Interface for up to 80 M-Bus devices
LSTAT-800-G3-Lx	Room Operator Panel, black front, white enclosure, Modbus, temperature, rel. humidity, ext. switch/NTC, IR receiver, Buttons (Lx)
LSTAT-801-G3-Lx	Room Operator Panel, front black, white enclosure, Modbus, temperature, rel. humidity, ext. switch/NTC, occupancy, IR receiver, Buttons (Lx)
LSTAT-802-G3-Lx	Room Operator Panel, front black, white enclosure, Modbus, temperature, rel. humidity, ext. switch/NTC, occupancy, IR receiver, CO2, Buttons (Lx)
LSTAT-800-G3-L20x	Room Operator Panel, white front, white enclosure, Modbus, temperature, rel. humidity, ext. switch/NTC, IR receiver, Buttons (Lx)
LSTAT-801-G3-L20x	Room Operator Panel, white front, white enclosure, Modbus, temperature, rel. humidity, ext. switch/NTC, occupancy, IR receiver, Buttons (Lx)
LSTAT-802-G3-L20x	Room Operator Panel, white front, white enclosure, Modbus, temperature, rel. humidity, ext. switch/NTC, occupancy, IR receiver, CO2, Buttons (Lx)
LSTAT-80x-CUSTOM	One-time customization cost for L-STAT custom design, including 2 working samples

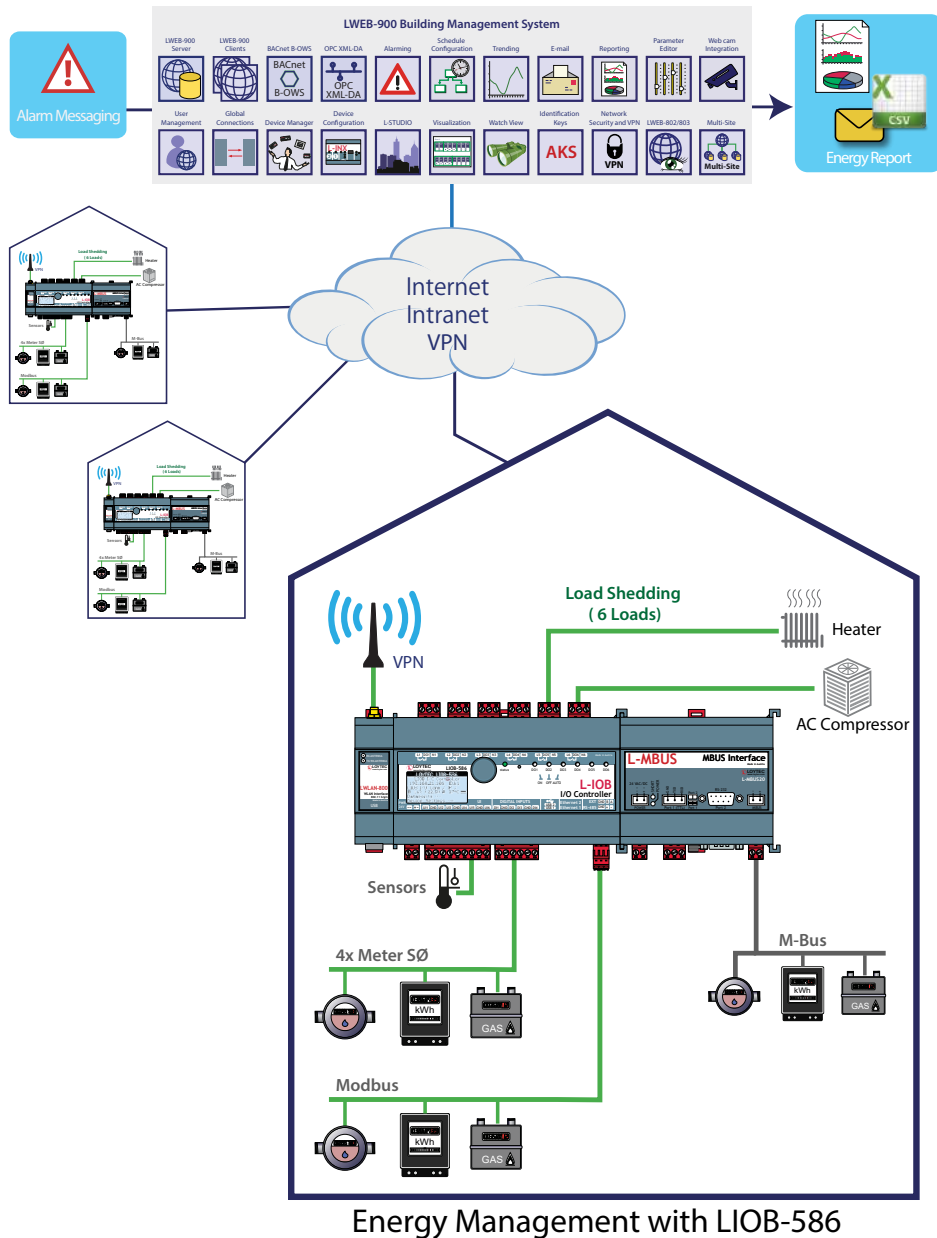



LIOB-590 I/O Controllers are IP-enabled, compact, programmable automation stations for LonMark Systems, BACnet/IP and BACnet/SC networks with bidirectional I/Os configurable as either input or output and integrated graphical visualization.

Communication

The LIOB-590 I/O Controller is equipped with two Ethernet ports including a built-in Ethernet switch. This allows for building a daisy chained line topology of up to 20 devices, which reduces costs for network installation. Dual Ethernet port devices also allow the setup of a redundant Ethernet installation (ring topology), which increases reliability. The redundant Ethernet topology is enabled by the Rapid Spanning Tree Protocol (RSTP), which is supported by most managed switches.

Technology data points are automatically exposed as OPC tags for higher level OPC client applications or L-WEB system via the integrated OPC server providing TSL encrypted web services (OPC XML-DA) or UA Secure Conversation (OPC UA). The L-IOB I/O Controllers further allow data exchange over global connections (network-wide data exchange), offer AST™ functions (Alarming, Scheduling, and Trending), store custom graphic pages for visualization in LWEB-802/803, and can be seamlessly integrated in the LWEB-900 Building Management System. LIOB-590 I/O Controllers implement the BACnet Building Controller (B-BC) profile and are BTL certified.

IoT Integration

The IoT function (Node.js) allows connecting the system to almost any cloud service, either for uploading historical data to analytics services, telemetry using MQTT, delivering alarm messages to alarm processing services or operating parts of the control system over a cloud service (e.g., scheduling based on Web calendars or booking systems). Processing Internet information such as weather data in forecast-based control is also possible. Finally, the JavaScript kernel also allows implementing serial protocols to non-standard equipment in primary plant control.

Local Operation and Override

All L-IOB I/O Controllers are equipped with an LCD display (128x64) with backlight and jog dial for manual local operation and override. Device and data point information is displayed in text form and via graphical symbols.

Features

- Automation station with bidirectional I/Os configurable as either input or output
- Programmable with L-STUDIO (IEC 61131-3 or IEC 61499)
- Room controller for up to 2 room segments
- Node.js support¹ for easy IoT integration (e.g. Google calendar, MQTT, Alexa & friends, multimedia equipment,...)
- Dual Ethernet/IP interface
- Manual operation using the jog dial or VNC client
- 128x64 graphic display with backlight
- Local and remote access to information about device status and data points
- Visualization of customized graphical pages through LWEB-900 (Building Management), LWEB-803 (Monitoring and Control), or LWEB-802 (Web Browser)
- Integrated web server for device configuration and monitoring data points
- Gateway functions including Smart Auto-Connect™
- Access to network statistics
- Compliant with CEA-709, CEA-852, and ISO/IEC 14908 Standard (LonMark System)
- Compliant with ANSI/ASHRAE 135-2012 and ISO 16484-5:2012 standard
- Supports BACnet/ IP, BACnet/SC
- B-BC (BACnet Building Controller) functionality, BTL certified
- BACnet Client Function (Write Property, Read Property, COV Subscription)
- BACnet Client Configuration with configuration tool (scan and EDE import)
- Supports IP-852 (Ethernet/ IP)

¹ requires L-IOT1 software license

L-IOB I/O Controller

LIOB-590

- Support of dynamically created or static NVs
- Support of user-defined NVs (UNVTs) and Configuration Properties (SCPTs, UCPTs)
- Alarming, Scheduling, and Trending (AST™)
- Event-driven e-mail notification
- Math objects to execute mathematical operations on data points
- 20 x Universal I/O (IO)
- Built-in OPC XML-DA and OPC UA server
- Stores customized graphical pages
- Stores user-defined project documentation

General Specifications

Dimensions (mm)	107 x 100 x 75 (L x W x H), DIM063
Installation	DIN rail mounting following DIN 43880, top hat rail EN 50022
Operating conditions	0 °C to 50 °C, 10 – 90 % RH, noncondensing, degree of protection: IP40, IP20 (terminals)
Power supply	24 VDC / 24 VAC ±10 % via L-POW, or with an external power supply
Program cycle time	Down to 10 ms
Interface	2 x Ethernet (100Base-T): Web services (OPC XML-DA, OPC UA), LonMark IP-852, BACnet/ IP, BACnet/SC Modbus TCP (Master or Slave), HTTP, FTP, SSH, HTTPS, Firewall, VNC, SNMP
Max. number of Rooms/Segments	2

Resource limits

Total number of data points	10 000	CEA-709 External NVs (polling)	500
OPC data points	5 000	CEA-709 address table entries	256 (non-ECS mode: 15)
BACnet objects	500 (analog, binary, multi-state)	LonMark Calendars	1 (25 calendar patterns)
BACnet client mappings	500	LonMark Schedulers	10
BACnet calendar objects	25	LonMark Alarm Servers	1
BACnet scheduler objects	10 (64 data points per object)	E-mail templates	50
BACnet notification classes	32	Math objects	50
Trend logs (BACnet or generic)	256 (13 000 000 entries, ≈ 200 MB)	Alarm logs	10
Total trended data points	256	Modbus data points	300
CEA-709 network variables (NVs)	500	Connections (Local / Global)	500 / 100
CEA-709 Alias NVs	500	Number of L-WEB clients	32 (simultaneously)

Runtime licenses

Programming, Tools	L-STUDIO software (IEC 61131-3 or IEC 61499), L-INX Configurator
License	L-STUDIO: included

Specifications

Power consumption	4.5 W ²
Universal I/O (IO)	20
I/O Specification	Please refer to the " General Input and Output Specification of LOYTEC devices " at the end of the L-IOB section for more details.

Order number	Product description
LIOB-590	L-IOB I/O Controller: 20 Universal I/O (IO)
L-STUDIO	Development and integration platform for programmable LOYTEC controllers
L-IOT1	Add-on Software License to enable IoT functionality on LIOB-585/586/587/588/589/59x, LIOB-AIR, and LINX-102/103/202/203
LPOW-2415A	LIOB-Connect power supply unit, 24 VDC, 15 W
LPOW-2415B	Power supply unit with power connector 24 VDC, 15 W
L-TEMP2	External temperature sensor (NTC10K) for use with L-IOB Universal Inputs

² Add external load: Sum of max. current drawn from all outputs x 24V

- ✓ BACnet
- ✓ DALI
- ✓ OPC

- ✓ Modbus



Datasheet #89072124

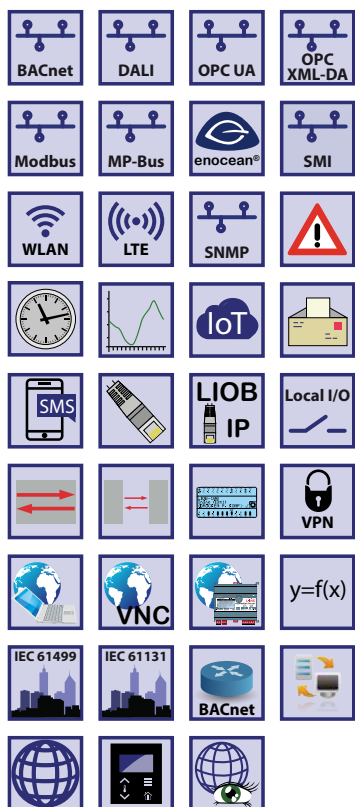

The LIOB-591 fan coil controller provides the basis for a revolutionary room automation system based on IP, which seamlessly integrates with native BACnet/IP networks at the controller level. Together with the L-STUDIO software, room control solutions can be created with little effort. Integral parts of the room control system are a web-based room operation via an LWEB-802/803 dashboard and the automatic generation of graphics for the L-PAD / L-VIS Touch Panel for local operation. LIOB-591 Controllers implement the BACnet Building Controller (B-BC) profile and are BTL certified.

Our room controllers provide all common interfaces and a large number of physical I/Os for room automation projects. DALI lamps and DALI sensors are connected to the DALI interface with an integrated DALI power supply. Up to 16 SMI sunblind motors connect to an external SMI interface. Belimo valves connect to the external MP-Bus interface. BACnet MS/TP devices connect to the RS-485 interface, which can also be configured as a Modbus RTU interface to connect Modbus devices like energy meters or ekey finger scanners for access control or to connect the L-STAT room operator panel. EnOcean devices connect to the external EnOcean interface. Dual Ethernet ports allow daisy chaining of LIOB-591 controllers in a ring topology and provide BACnet/IP, Modbus/IP and OPC communication.

Optionally the LIOB-591 can communicate via wireless LAN through the LWLAN-800 wireless adapter connected to the USB port. 20 universal I/Os, one 1250 W and three 300 W TRIAC outputs connect various physical input and output devices. Our room automation library provides pre-built function modules for all lighting, heating, cooling, ventilation, sunblinds and access control via finger scanners. Built-in TSL encryption ensures secure operation of the room automation system.

All typical room functions are supported:

- Lighting control with constant light controller
- Sunblind control with angle adjustment and year shade progression
- Temperature control for heating, cooling, and ventilation
- Occupancy detection
- Window monitoring and window contact

Features

- Room controller for 1 room segment
- Networking via redundant IP network
- Programmable with L-STUDIO (IEC 61131-3 or IEC 61499)
- Extension with physical inputs and outputs using L-IOB I/O Modules (LIOB-45x or LIOB-55x)
- 128x64 graphic display with backlight for device configuration and maintenance
- Local display of device and data point information
- Manual operation using the jog dial or VNC Client
- Integrated AST™ functions (Alarming, Scheduling, and Trending) for each room segment
- Node.js support¹ for easy IoT integration (e.g. Google calendar, MQTT, Alexa & friends, multimedia equipment,...)
- Event-driven e-mail notification
- Math objects to execute mathematical operations on data points
- Stores customized graphic pages
- Visualization of customized graphic pages through LWEB-900 (Building Management), LWEB-803 (Monitoring and Control), or LWEB-802 (Web Browser)
- Support of the L-STAT Room Operator Panel
- Built-in OPC XML-DA and OPC UA server
- Access to network statistics via SNMP
- Compliant with ANSI/ASHRAE 135-2012 and ISO 16484-5:2012 standard
- Supports BACnet/IP, BACnet/SC and BACnet MS/TP
- BACnet Client Function (Write Property, Read Property, COV Subscription)
- BACnet Client Configuration with configuration tool (scan and EDE import)
- B-BC (BACnet Building Controller) functionality, BTL certified
- Integrated BACnet/IP to BACnet/SC and BACnet MS/TP Router including BBMD as well as Slave-Proxy functionality
- Modbus TCP and Modbus RTU/ASCII (Master or Slave)
- Integrated web server for device configuration and monitoring data points

¹ requires L-IOT1 software license

L-IOB Room Controller

LIOB-591

- DALI integration of up to 64 DALI lamps
- Integrated DALI power supply, 16 VDC, 116 mA max. current
- Integrated 1250 W heater control
- Integrated dual fan motor control
- 8 x Universal I/O (U, I, R), 12 x Universal I/O (U) ²
- Integrated heating/cooling valve control
- Supports VPN
- Configurable Bluetooth beacons and services: indoor navigation, asset tracking (requires LIC-ASSET license) and access to LWEB-900 room control solution

General Specifications

Dimensions (mm)	199 x 87 x 62 (L x W x H), DIM065
Installation	mountable directly via two oblong holes (ø 4.5 mm, distance 187 mm)
Power supply	85 – 240 V AC, 50 – 60 Hz
Operating conditions	0 °C to 45 °C, 10 – 90 % RH, noncondensing, degree of protection: IP30, IP20 (terminals)

Specifications

Type	LIOB-591
Power consumption	max. 15 W ³
Interfaces	<p>2 x Ethernet (100Base-T): Web services (OPC XML-DA, OPC UA), BACnet/IP*, BACnet/SC*, LIOB-IP, Modbus TCP (Master or Slave), HTTP, FTP, SSH, HTTPS, Firewall, VNC, SNMP, VPN</p> <p>2 x USB-A: WLAN (needs LWLAN-800), EnOcean (needs LENO-80x), MP-Bus (needs LMPBUS-804), SMI (needs LSMI-804), LTE (needs LTE-800)</p> <p>1 x RS-485 (ANSI TIA/EIA-485): BACnet MS/TP* or Modbus RTU/ASCII (Master or Slave) or L-STAT (Room operator panel)</p> <p>1 x DALI with integrated DALI bus power supply 16 VDC, 116 mA max. supply current ⁴</p> <p><i>* Router between BACnet/IP, BACnet/SC and BACnet MS/TP</i></p>
Universal I/O (IO)	8 x Universal I/O (U, I, R), 12 x Universal I/O (U) ²
Digital Output (DO)	1 x TRIAC 1250 W, 230 V AC (connector for overtemperature safety device) 3 x TRIAC 300 W, 230 V AC
Input and Output specification	Please refer to the "General Input and Output Specification of LOYTEC devices" at the end of the L-IOB section for more details.
L-IOB I/O extension	1 L-IOB I/O Modules of Type LIOB-45x or LIOB-55x
BACnet/IP Router	1
Program cycle time	Event-triggered, 10 ms
Max. number of Rooms/Segments	1
SMI devices via LSMI-804	16
SMI devices (maximum)	16
EnOcean devices via LENO-80x	10
EnOcean devices (maximum)	10
EnOcean devices commissioning limit	10
L-STAT Room Operator Panels	1
DALI devices	64
DALI groups	16
DALI sensors	16
DALI pushbuttons (LDALI-BM2)	64 pushbutton coupler
MP-Bus devices via LMPBUS-804	8 (16 MPL)
MP-Bus devices (maximum)	16

² U: 0-10V input or 0-10V output, I: 4-20 mA input, R: resistance measurement

³ Add external load: Sum of max. current drawn from all outputs x 24V + power drawn from USB and L-STAT connectors

⁴ With high DALI traffic (e.g. during DALI-scan) increased current consumption may occur depending on the devices connected. Therefore, according to IEC62386-101 it is recommended to take an additional current of at least 20% for dynamic processes into account in system design.

Runtime licenses			
Programming, Tools	L-STUDIO software (IEC 61131-3 or IEC 61499), L-INX Configurator		
License	L-STUDIO: included		
Resource limits			
Total number of data points	10 000	Math objects	50
OPC data points	5 000	Alarm logs	10
BACnet objects	500 (analog, binary, multi-state)	Modbus data points	300
BACnet client mappings	500	Connections (Local / Global)	2 000 / 250
BACnet calendar objects	25	Number of L-WEB clients	32 (simultaneously)
BACnet scheduler objects	100 (64 data points per object)	L-IOB I/O Modules (via LIOB-IP)	1
BACnet notification classes	32	EnOcean data points	10 per EnOcean device
Trend logs (BACnet or generic)	256 (13 000 000 entries, ≈ 200 MB)	SMI devices	16
Total trended data points	256	MP-Bus devices	8 (16 MPL)
E-mail templates	50		
Order number	Product description		
LIOB-591	L-IOB Room Controller, 8 x Universal I/O (U, I, R), 12 x Universal I/O (U), 1 x TRIAC 1250 W, 3 x TRIAC 300 W		
L-STUDIO	Development and integration platform for programmable LOYTEC controllers		
L-IOT1	Add-on Software License to enable IoT functionality on LIOB-585/586/587/588/589/59x, LIOB-AIR, and LINX-102/103/202/203		
LIC-ASSET	Add-on Software License to activate asset tracking (for LDALI-ME20x-U, LDALI-3E10x-U, LDALI-PLCx, LROC-400, LROC-401, LIOB-AIR20, LIOB-591)		
LENO-800	EnOcean Interface 868 MHz Europe		
LENO-801	EnOcean Interface 902 MHz USA/Canada		
LENO-802	EnOcean Interface 928 MHz Japan		
LWLAN-800	Wireless LAN Interface IEEE 802.11 bgn		
LTE-800	LTE Interface		
LRS232-802	USB to 2 x RS-232 Interface		
LMPBUS-804	MP-Bus interface for 16 devices per channel, up to 4 channels		
LSMI-804	Standard Motor Interface for 64 motors, 4 SMI channels via USB		
LSTAT-800-G3-Lx	Room Operator Panel, black front, white enclosure, Modbus, temperature, rel. humidity, ext. switch/NTC, IR receiver, Buttons (Lx)		
LSTAT-801-G3-Lx	Room Operator Panel, front black, white enclosure, Modbus, temperature, rel. humidity, ext. switch/NTC, occupancy, IR receiver, Buttons (Lx)		
LSTAT-802-G3-Lx	Room Operator Panel, front black, white enclosure, Modbus, temperature, rel. humidity, ext. switch/NTC, occupancy, IR receiver, CO2, Buttons (Lx)		
LSTAT-800-G3-L20x	Room Operator Panel, white front, white enclosure, Modbus, temperature, rel. humidity, ext. switch/NTC, IR receiver, Buttons (Lx)		
LSTAT-801-G3-L20x	Room Operator Panel, white front, white enclosure, Modbus, temperature, rel. humidity, ext. switch/NTC, occupancy, IR receiver, Buttons (Lx)		
LSTAT-802-G3-L20x	Room Operator Panel, white front, white enclosure, Modbus, temperature, rel. humidity, ext. switch/NTC, occupancy, IR receiver, CO2, Buttons (Lx)		
LSTAT-80x-CUSTOM	One-time customization cost for L-STAT custom design, including 2 working samples		
LDALI-MS2-BT	DALI multi-sensor (presence detection, illuminance sensor, IR receiver, temperature sensor, humidity sensor, 3 digital inputs, Bluetooth), up to 12 m mounting height		
LDALI-MS3-BT	DALI multi-sensor (presence detection, illuminance sensor, IR receiver, temperature sensor, humidity sensor, 3 digital inputs, Bluetooth), up to 12 m mounting height		
LDALI-MS4-BT	DALI multi-sensor (presence detection, illuminance sensor, IR receiver, temperature sensor, humidity sensor, 3 digital inputs, Bluetooth, flat lense), up to 5 m mounting height		
LDALI-BM2	Quadruple DALI pushbutton coupler		
LDALI-RM5	DALI Relay Module 10 A, Analog Interface 1 – 10 V		
LDALI-RM6	DALI Relay Module 10 A, Analog Interface 1 – 10 V, “spud-mount”		
LDALI-RM8	DALI Relay Module, 8-channel		
L-TEMP2	External temperature sensor (NTC10K) for use with L-IOB Universal Inputs		

L-IOB I/O Controller

LIOB-592

Datasheet #89084924



- ✓ BACnet
- ✓ Modbus
- ✓ CEA-709
- M-Bus
- KNX
- ✓ OPC



LIOB-592 I/O Controllers are IP-enabled, compact, programmable BACnet Building Controller (B-BC) with physical inputs and outputs and integrated graphical visualization.

BACnet/IP over Ethernet

The LIOB-592 I/O Controllers are equipped with two Ethernet ports including a built-in Ethernet switch. This allows for building a daisy chained line topology of up to 20 devices, which reduces costs for network installation. Dual Ethernet port devices also allow the setup of a redundant Ethernet installation (ring topology), which increases reliability. The redundant Ethernet topology is enabled by the Rapid Spanning Tree Protocol (RSTP), which is supported by most managed switches.

Technology data points are automatically exposed as OPC tags for higher level OPC client applications or L-WEB system via the integrated OPC server providing TSL encrypted web services (OPC XML-DA) or UA Secure Conversation (OPC UA). The L-IOB I/O Controllers further allow data exchange over global connections (network-wide data exchange), offer AST™ functions (Alarming, Scheduling, and Trending), store custom graphic pages for visualization in LWEB-802/803, and can be seamlessly integrated in the LWEB-900 Building Management System. LIOB-592 I/O Controllers implement the BACnet Building Controller (B-BC) profile and are BTL certified.

IoT Integration

The IoT function (Node.js) allows connecting the system to almost any cloud service, either for uploading historical data to analytics services, telemetry using MQTT, delivering alarm messages to alarm processing services or operating parts of the control system over a cloud service (e.g., scheduling based on Web calendars or booking systems). Processing Internet information such as weather data in forecast-based control is also possible. Finally, the JavaScript kernel also allows implementing serial protocols to non-standard equipment in primary plant control.

Local Operation and Override

All L-IOB I/O Controllers are equipped with an LCD display (128x64) with backlight and jog dial for manual local operation and override. Device and data point information is displayed in text form and via graphical symbols.

Features

- Automation station with bidirectional I/Os configurable as either input or output
- Programmable with L-STUDIO (IEC 61131-3 or IEC 61499)
- Room controller for up to 2 room segments
- Node.js support¹ for easy IoT integration (e.g. Google calendar, MQTT, Alexa & friends, multimedia equipment,...)
- Dual Ethernet/IP interface
- Manual operation using the jog dial or VNC client
- 128x64 graphic display with backlight
- Local and remote access to information about device status and data points
- Stores customized graphic pages
- Visualization of customized graphic pages through LWEB-900 (Building Management), LWEB-803 (Monitoring and Control), or LWEB-802 (Web Browser)
- Integrated web server for device configuration and monitoring data points
- Gateway functions including Smart Auto-Connect™
- Access to network statistics
- Compliant with CEA-709, CEA-852, and ISO/IEC 14908 Standard (LonMark System)
- Compliant with ANSI/ASHRAE 135-2012 and ISO 16484-5:2012 standard
- Supports BACnet MS/TP, BACnet/IP or BACnet/SC
- B-BC (BACnet Building Controller) functionality, BTL certified
- BACnet Client Function (Write Property, Read Property, COV Subscription)

¹ requires L-IOT1 software license

- BACnet Client Configuration with configuration tool (scan and EDE import)
- Supports IP-852 (Ethernet/ IP)
- Support of dynamically created or static NVs
- Support of user-defined NVs (UNVTs) and Configuration Properties (SCPTs, UCPTs)
- Integrated BACnet/IP to BACnet/SC and BACnet MS/TP Router including BBMD as well as Slave-Proxy functionality
- Alarming, Scheduling, and Trending (AST™)
- Event-driven e-mail and SMS (requires LTE-800) notification
- Math objects to execute mathematical operations on data points
- 40 x Universal I/O (IO) ³
- Built-in OPC XML-DA and OPC UA server
- Connection to EnOcean wireless devices via LENO-80x Interface
- Supports SMI (Standard Motor Interface) through LSMI-804
- Supports WLAN through LWLAN-800 Interface
- Supports MP-Bus through LMPBUS-804
- Supports LTE through LTE-800 Interface
- Supports RS-232 through LRS232-802 Interface
- Support of the L-STAT Room Operator Panel
- Stores user-defined project documentation
- Supports VPN

General Specifications

Type	LIOB-592
Dimensions (mm)	159 x 100 x 75 (L x W x H), DIM074
Installation	DIN rail mounting following DIN 43880, top hat rail EN 50022
Operating conditions	0 °C to 50 °C, 10 – 90 % RH, noncondensing, degree of protection: IP40, IP20 (terminals)
Power supply	24 VDC / 24 VAC ±10 %
Program cycle time	Down to 10 ms
Interface	<p>2 x Ethernet (100Base-T): Web services (OPC XML-DA, OPC UA), LonMark IP-852, BACnet/ IP*, BACnet/SC* Modbus TCP (Master or Slave), HTTP, FTP, SSH, HTTPS, Firewall, VNC, SNMP, VPN</p> <p>2 x USB-A: WLAN (needs LWLAN-800), EnOcean (needs LENO-80x), MP-Bus (needs LMPBUS-804), SMI (needs LSMI-804), LTE (needs LTE-800)</p> <p>1 x L-STAT (Room Operator panels) or Modbus RTU (Master or Slave) or BACnet MS/TP*</p> <p><i>* Router between BACnet/IP and BACnet MS/TP</i></p>
Max. number of Rooms/Segments	2

Specifications

Type	LIOB-592
Power consumption	4.5 W ²
Universal I/O (IO)	40 ³
I/O Specification	Please refer to the " General Input and Output Specification of LOYTEC devices " at the end of the L-IOB section for more details.

Runtime licenses

Programming, Tools	L-STUDIO software (IEC 61131-3 or IEC 61499), L-INX Configurator
License	L-STUDIO: included

² Add external load: Sum of max. current drawn from all outputs x 24V + power drawn from USB and L-STAT connectors

³ O29-O40 are internally connected to IO29-IO40 and provide 4-20 mA outputs in parallel to the 0-10 V outputs on IO29-IO40.

LIOB-592

Resource limits			
Total number of data points	10 000	LonMark Schedulers	10
OPC data points	5 000	LonMark Alarm Servers	1
BACnet objects	500 (analog, binary, multi-state)	E-mail templates	50
BACnet client mappings	500	Math objects	50
BACnet calendar objects	25	Alarm logs	10
BACnet scheduler objects	10 (64 data points per object)	Modbus data points	300
BACnet notification classes	32	Connections (Local / Global)	500 / 100
Trend logs (BACnet or generic)	256 (13 000 000 entries, ≈ 200 MB)	Number of L-WEB clients	32 (simultaneously)
Total trended data points	500	MP-Bus devices	8 (16 MPL)
CEA-709 network variables (NVs)	500	EnOcean devices (maximum)	10
CEA-709 Alias NVs	500	EnOcean data points	10 per EnOcean device
CEA-709 External NVs (polling)	500	L-STAT Network Thermostats	8
CEA-709 address table entries	256 (non-ECS mode: 15)	SMI devices	16
LonMark Calendars	1 (25 calendar patterns)		

Order number	Product description
LIOB-592	L-IOB I/O Controller: 40 Universal I/O (12 optionally with 4-20 mA Current Output)
L-STUDIO	Development and integration platform for programmable LOYTEC controllers
L-IOT1	Add-on Software License to enable IoT functionality on LIOB-585/586/587/588/589/59x, LIOB-AIR, and LINX-102/103/202/203
LENO-800	EnOcean Interface 868 MHz Europe
LENO-801	EnOcean Interface 902 MHz USA/Canada
LENO-802	EnOcean Interface 928 MHz Japan
LWLAN-800	Wireless LAN Interface IEEE 802.11 bgn
LTE-800	LTE Interface
LRS232-802	USB to 2 x RS-232 Interface
LMPBUS-804	MP-Bus interface for 16 devices per channel, up to 4 channels
LSMI-804	Standard Motor Interface for 64 motors, 4 SMI channels via USB
LSTAT-800-G3-Lx	Room Operator Panel, black front, white enclosure, Modbus, temperature, rel. humidity, ext. switch/NTC, IR receiver, Buttons (Lx)
LSTAT-801-G3-Lx	Room Operator Panel, front black, white enclosure, Modbus, temperature, rel. humidity, ext. switch/NTC, occupancy, IR receiver, Buttons (Lx)
LSTAT-802-G3-Lx	Room Operator Panel, front black, white enclosure, Modbus, temperature, rel. humidity, ext. switch/NTC, occupancy, IR receiver, CO2, Buttons (Lx)
LSTAT-800-G3-L20x	Room Operator Panel, white front, white enclosure, Modbus, temperature, rel. humidity, ext. switch/NTC, IR receiver, Buttons (Lx)
LSTAT-801-G3-L20x	Room Operator Panel, white front, white enclosure, Modbus, temperature, rel. humidity, ext. switch/NTC, occupancy, IR receiver, Buttons (Lx)
LSTAT-802-G3-L20x	Room Operator Panel, white front, white enclosure, Modbus, temperature, rel. humidity, ext. switch/NTC, occupancy, IR receiver, CO2, Buttons (Lx)
LSTAT-80x-CUSTOM	One-time customization cost for L-STAT custom design, including 2 working samples
LPOW-2415A	LIOB-Connect power supply unit, 24 VDC, 15 W
LPOW-2415B	Power supply unit with power connector 24 VDC, 15 W
L-TEMP2	External temperature sensor (NTC10K) for use with L-IOB Universal Inputs

- ✓ BACnet
- ✓ CEA-709
- KNX
- ✓ Modbus
- ✓ MP-Bus
- ✓ OPC



Datasheet #89079324



LIOB-593 I/O Controllers are IP-enabled, compact, programmable BACnet Building Controller (B-BC) with physical inputs and outputs and integrated graphical visualization.

Communication

LIOB-593 I/O Controllers are equipped with two Ethernet ports including a built-in Ethernet switch. This allows for building a daisy chained line topology of up to 20 devices, which reduces costs for network installation. Dual Ethernet port devices also allow the setup of a redundant Ethernet installation (ring topology), which increases reliability. The redundant Ethernet topology is enabled by the Rapid Spanning Tree Protocol (RSTP), which is supported by most managed switches.

Technology data points are automatically exposed as OPC tags for higher level OPC client applications or L-WEB system via the integrated OPC server providing TSL encrypted web services (OPC XML-DA) or UA Secure Conversation (OPC UA). The L-IOB I/O Controllers further allow data exchange over global connections (network-wide data exchange), offer AST™ functions (Alarming, Scheduling, and Trending), store custom graphic pages for visualization in LWEB-802/803, and can be seamlessly integrated in the LWEB-900 Building Management System. The L-IOB I/O Controllers implement the BACnet Building Controller (B-BC) profile and are BTL certified.

IoT Integration

The IoT function (Node.js) allows connecting the system to almost any cloud service, either for uploading historical data to analytics services, telemetry using MQTT, delivering alarm messages to alarm processing services or operating parts of the control system over a cloud service (e.g., scheduling based on Web calendars or booking systems). Processing Internet information such as weather data in forecast-based control is also possible. Finally, the JavaScript kernel also allows implementing serial protocols to non-standard equipment in primary plant control.

Local Operation and Override

All L-IOB I/O Controllers are equipped with an LCD display (128x64) with backlight and jog dial for manual local operation and override. Device and data point information is displayed in text form and via graphical symbols.

Features

- Automation station with physical inputs and outputs
- Programmable with L-STUDIO IEC 61131-3 and IEC 61499
- Room controller for up to 2 room segments
- 128x64 graphic display with backlight
- Local and remote access to information about device status and data points
- Manual operation using the jog dial or VNC client
- Node.js support¹ for easy IoT integration (e.g. Google calendar, MQTT, Alexa & friends, multimedia equipment,...)
- Event-driven e-mail and SMS (requires LTE-800) notification
- Math objects to execute mathematical operations on data points
- Stores customized graphic pages
- Visualization of customized graphic pages through LWEB-900 (Building Management), LWEB-803 (Monitoring and Control), or LWEB-802 (Web Browser)
- Support of the L-STAT Room Operator Panel
- Built-in OPC XML-DA and OPC UA server
- Dual Ethernet/IP interface
- Access to network statistics
- Compliant with ANSI/ASHRAE 135-2012 and ISO 16484-5:2012 standard

¹ requires L-IOT1 software license

L-IOB I/O Controller

LIOB-593

- Supports BACnet MS/TP, BACnet/IP or BACnet/SC
- BACnet Client Function (Write Property, Read Property, COV Subscription)
- BACnet Client Configuration with configuration tool (scan and EDE import)
- B-BC (BACnet Building Controller) functionality, BTL certified
- Compliant with CEA-709, CEA-852, and ISO/IEC 14908 Standard (LonMark System)
- Supports IP-852 (Ethernet/ IP)
- Support of dynamically created or static NVs
- Support of user-defined NVs (UNVTs) and Configuration Properties (SCPTs, UCPTs)
- Integrated BACnet/IP to BACnet/SC and BACnet MS/TP Router including BBMD as well as Slave-Proxy functionality
- Alarming, Scheduling, and Trending (AST™)
- Gateway functions including Smart Auto-Connect™
- Integrated web server for device configuration and monitoring data points
- Stores user-defined project documentation
- Connection to EnOcean wireless devices via LENO-80x Interface
- Supports WLAN through LWLAN-800 Interface
- Supports LTE through LTE-800 Interface
- Integration of damper actuator via MP-Bus
- 8 x Universal I/O (U, I, R), 8 x Universal I/O (U) ³
- Support VPN

General Specifications

Type	LIOB-593
Dimensions (mm)	107 x 100 x 75 (L x W x H), DIM075
Installation	DIN rail mounting following DIN 43880, top hat rail EN 50022
Purpose of control	Operating control
Construction of control	Independently mounted control
Feature of automatic action	Type 1
Operating conditions	0 °C to 50 °C, 10–90 % RH, noncondensing, degree of protection: IP40, IP20 (terminals), pollution degree 2
Power supply	24 VDC/ V AC SELV ±10 % via LPOW-2415B, or with an external power supply
Rated Impulse Voltage	2500 V
Program cycle time	Down to 10 ms
Interface	2 x Ethernet (100Base-T): Web services (OPC XML-DA, OPC UA), LonMark IP-852, BACnet/IP*, BACnet/SC* Modbus TCP (Master or Slave), HTTP, FTP, SSH, HTTPS, Firewall, VNC, SNMP, VPN 2 x USB-A: WLAN (needs LWLAN-800), EnOcean (needs LENO-80x), LTE (needs LTE-800) 1 x RS-485 (ANSI TIA/EIA-485): BACnet MS/TP* or Modbus RTU (Master or Slave) or L-STAT (Room Operator Panels) 1 x MP-Bus * Router between BACnet/IP, BACnet/SC and BACnet MS/TP

Max. number of Rooms/Segments	2
-------------------------------	---

Specifications

Type	LIOB-593
Power consumption	4.5 W ²
Universal I/O (IO)	8 x Universal I/O (U, I, R), 8 x Universal I/O (U) ³
Digital Output (DO)	7 (5x Relay 2A, 2x Relay 6A)
Digital Output specification	Please refer to the " General Input and Output Specification of LOYTEC devices " for more details.

² Add external load: Sum of max. current drawn from all outputs x 24V + power drawn from USB connectors

³ U: 0-10V input or 0-10V output, I: 4-20 mA input, R: resistance measurement

Resource limits			
Total number of data points	10 000	LonMark Calendars	1 (25 calendar patterns)
OPC data points	5 000	LonMark Schedulers	10
BACnet objects	1000 (analog, binary, multi-state)	LonMark Alarm Servers	1
BACnet client mappings	200	E-mail templates	50
BACnet calendar objects	25	Math objects	50
BACnet scheduler objects	10 (64 data points per object)	Alarm logs	10
BACnet notification classes	32	Modbus data points	500
Trend logs (BACnet or generic)	256 (13 000 000 entries, ≈ 200 MB)	Connections (Local / Global)	500 / 100
Total trended data points	256	Number of L-WEB clients	32 (simultaneously)
CEA-709 network variables (NVs)	1000	L-STAT Room Operator Panels	8
CEA-709 Alias NVs	1000	EnOcean devices	10
CEA-709 External NVs (polling)	500	EnOcean data points	100
CEA-709 address table entries	256 (non-ECS mode: 15)	MP-Bus devices (per channel)	8 (16 MPL)

Runtime licenses	
Type	LIOB-593
Programming, Tools	L-STUDIO software (IEC 61131-3 or IEC 61499), L-INX Configurator
License	L-STUDIO: included

Order number	Product description
LIOB-593	L-IOB I/O Controller: 8 x Universal I/O (U, I, R), 8 x Universal I/O (U), 7 DO (5 x Relay 2A, 2 x Relay 6A)
L-STUDIO	Development and integration platform for programmable LOYTEC controllers
L-IOT1	Add-on Software License to enable IoT functionality on LIOB-585/586/587/588/589/59x, LIOB-AIR, and LINX-102/103/202/203
L-ACT101-MP	Actuator 5/8", 5 Nm, 45in-lb, MP-Bus cable
L-ACT102-MP	Actuator 3/4", 5 Nm, 45in-lb, MP-Bus cable
LPOW-2415B	Power supply unit with power connector 24 VDC, 15 W
L-TEMP2	External temperature sensor (NTC10K) for use with L-IOB Universal Inputs
LENO-800	EnOcean Interface 868 MHz Europe
LENO-801	EnOcean Interface 902 MHz USA/Canada
LENO-802	EnOcean Interface 928 MHz Japan
LWLAN-800	Wireless LAN Interface IEEE 802.11bgn
LTE-800	LTE Interface
LSTAT-800-G3-Lx	Room Operator Panel, black front, white enclosure, Modbus, temperature, rel. humidity, ext. switch/NTC, IR receiver, Buttons (Lx)
LSTAT-801-G3-Lx	Room Operator Panel, front black, white enclosure, Modbus, temperature, rel. humidity, ext. switch/NTC, occupancy, IR receiver, Buttons (Lx)
LSTAT-802-G3-Lx	Room Operator Panel, front black, white enclosure, Modbus, temperature, rel. humidity, ext. switch/NTC, occupancy, IR receiver, CO2, Buttons (Lx)
LSTAT-800-G3-L20x	Room Operator Panel, white front, white enclosure, Modbus, temperature, rel. humidity, ext. switch/NTC, IR receiver, Buttons (Lx)
LSTAT-801-G3-L20x	Room Operator Panel, white front, white enclosure, Modbus, temperature, rel. humidity, ext. switch/NTC, occupancy, IR receiver, Buttons (Lx)
LSTAT-802-G3-L20x	Room Operator Panel, white front, white enclosure, Modbus, temperature, rel. humidity, ext. switch/NTC, occupancy, IR receiver, CO2, Buttons (Lx)
LSTAT-80x-CUSTOM	One-time customization cost for L-STAT custom design, including 2 working samples



- ✓ BACnet
- ✓ CEA-709
- KNX

- ✓ Modbus
- ✓ MP-Bus
- ✓ OPC



LIOB-594 I/O Controllers are IP-enabled, compact, programmable BACnet Building Controller (B-BC) with physical inputs and outputs and integrated graphical visualization.

Communication

LIOB-594 I/O Controllers are equipped with two Ethernet ports including a built-in Ethernet switch. This allows for building a daisy chained line topology of up to 20 devices, which reduces costs for network installation. Dual Ethernet port devices also allow the setup of a redundant Ethernet installation (ring topology), which increases reliability. The redundant Ethernet topology is enabled by the Rapid Spanning Tree Protocol (RSTP), which is supported by most managed switches.

Technology data points are automatically exposed as OPC tags for higher level OPC client applications or L-WEB system via the integrated OPC server providing TSL encrypted web services (OPC XML-DA) or UA Secure Conversation (OPC UA). The L-IOB I/O Controllers further allow data exchange over global connections (network-wide data exchange), offer AST™ functions (Alarming, Scheduling, and Trending), store custom graphic pages for visualization in LWEB-802/803, and can be seamlessly integrated in the LWEB-900 Building Management System. The L-IOB I/O Controllers implement the BACnet Building Controller (B-BC) profile and are BTL certified.

IoT Integration

The IoT function (Node.js) allows connecting the system to almost any cloud service, either for uploading historical data to analytics services, telemetry using MQTT, delivering alarm messages to alarm processing services or operating parts of the control system over a cloud service (e.g., scheduling based on Web calendars or booking systems). Processing Internet information such as weather data in forecast-based control is also possible. Finally, the JavaScript kernel also allows implementing serial protocols to non-standard equipment in primary plant control.

Local Operation and Override

All L-IOB I/O Controllers are equipped with an LCD display (128x64) with backlight and jog dial for manual local operation and override. Device and data point information is displayed in text form and via graphical symbols.

Features

- Automation station with physical inputs and outputs
- Programmable with L-STUDIO IEC 61131-3 and IEC 61499
- Room controller for up to 2 room segments
- 128x64 graphic display with backlight
- Local and remote access to information about device status and data points
- Manual operation using the jog dial or VNC client
- Alarming, Scheduling, and Trending (AST™)
- Node.js support¹ for easy IoT integration (e.g. Google calendar, MQTT, Alexa & friends, multimedia equipment,...)
- Event-driven e-mail and SMS (requires LTE-800) notification
- Math objects to execute mathematical operations on data points
- Stores customized graphic pages
- Visualization of customized graphic pages through LWEB-900 (Building Management), LWEB-803 (Monitoring and Control), or LWEB-802 (Web Browser)
- Support of the L-STAT Room Operator Panel
- Built-in OPC XML-DA and OPC UA server
- Dual Ethernet/IP interface
- Access to network statistics
- Compliant with ANSI/ASHRAE 135-2012 and ISO 16484-5:2012 standard

¹ requires L-IOT1 software license

- Supports BACnet MS/TP, BACnet/IP or BACnet/SC
- BACnet Client Function (Write Property, Read Property, COV Subscription)
- BACnet Client Configuration with configuration tool (scan and EDE import)
- B-BC (BACnet Building Controller) functionality, BTL certified
- Compliant with CEA-709, CEA-852, and ISO/IEC 14908 Standard (LonMark System)
- Supports IP-852 (Ethernet/ IP)
- Support of dynamically created or static NVs
- Support of user-defined NVs (UNVTs) and Configuration Properties (SCPTs, UCPTs)
- Integrated BACnet/IP to BACnet/SC and BACnet MS/TP Router including BBMD as well as Slave-Proxy functionality
- Gateway functions including Smart Auto-Connect™
- Integrated web server for device configuration and monitoring data points
- Stores user-defined project documentation
- Connection to EnOcean wireless devices via LENO-80x Interface
- Supports WLAN through LWLAN-800 Interface
- Supports LTE through LTE-800 Interface
- Integration of damper actuator via MP-Bus
- 8 x Universal I/O (U, I, R) ³
- Support VPN

General Specifications

Type	LIOB-594
Dimensions (mm)	107 x 100 x 75 (L x W x H), DIM076
Installation	DIN rail mounting following DIN 43880, top hat rail EN 50022
Purpose of control	Operating control
Construction of control	Independently mounted control
Feature of automatic action	Type 1
Operating conditions	0 °C to 50 °C, 10–90 % RH, noncondensing, degree of protection: IP40, IP20 (terminals), pollution degree 2
Power supply	24 VDC/ VAC SELV ±10 % via LPOW-2415B, or with an external power supply
Rated Impulse Voltage	2500 V
Program cycle time	Down to 10 ms
Interface	2 x Ethernet (100Base-T): Web services (OPC XML-DA, OPC UA), LonMark IP-852, BACnet/IP*, BACnet/SC* Modbus TCP (Master or Slave), HTTP, FTP, SSH, HTTPS, Firewall, VNC, SNMP, VPN 2 x USB-A: WLAN (needs LWLAN-800), EnOcean (needs LENO-80x), LTE (needs LTE-800) 1 x RS-485 (ANSI TIA/EIA-485): BACnet MS/TP* or Modbus RTU (Master or Slave) or L-STAT (Room Operator Panels) 1 x MP-Bus * Router between BACnet/IP, BACnet/SC and BACnet MS/TP

Max. number of Rooms/Segments	2
-------------------------------	---

Specifications

Type	LIOB-594
Power consumption	4.5 W ²
Universal I/O (IO)	8 x Universal I/O (U, I, R) ³
Digital Output (DO)	7 (5x Relay 2A, 2x Relay 6A)
Digital Output specification	Please refer to the " General Input and Output Specification of LOYTEC devices " for more details.

² Add external load: Sum of max. current drawn from all outputs x 24V + power drawn from USB connectors

³ U: 0-10V input or 0-10V output, I: 4-20 mA input, R: resistance measurement

LIOB-594

Resource limits			
Total number of data points	10 000	LonMark Calendars	1 (25 calendar patterns)
OPC data points	5 000	LonMark Schedulers	10
BACnet objects	500 (analog, binary, multi-state)	LonMark Alarm Servers	1
BACnet client mappings	500	E-mail templates	50
BACnet calendar objects	25	Math objects	50
BACnet scheduler objects	10 (64 data points per object)	Alarm logs	10
BACnet notification classes	32	Modbus data points	300
Trend logs (BACnet or generic)	256 (13 000 000 entries, ≈ 200 MB)	Connections (Local / Global)	500 / 100
Total trended data points	256	Number of L-WEB clients	32 (simultaneously)
CEA-709 network variables (NVs)	500	L-STAT Room Operator Panels	8
CEA-709 Alias NVs	500	EnOcean devices	10
CEA-709 External NVs (polling)	500	EnOcean data points	100
CEA-709 address table entries	256 (non-ECS mode: 15)	MP-Bus devices (per channel)	8 (16 MPL)

Runtime licenses	
Type	LIOB-594
Programming, Tools	L-STUDIO software (IEC 61131-3 or IEC 61499), L-INX Configurator
License	L-STUDIO: included

Order number	Product description
LIOB-594	L-IOB I/O Controller: 8 x Universal I/O (U, I, R), 7 DO (5 x Relay 2A, 2 x Relay 6A)
L-STUDIO	Development and integration platform for programmable LOYTEC controllers
L-ACT101-MP	Actuator 5/8", 5 Nm, 45in-lb, MP-Bus cable
L-ACT102-MP	Actuator 3/4", 5 Nm, 45in-lb, MP-Bus cable
LPOW-2415B	Power supply unit with power connector 24 VDC, 15 W
L-IOT1	Add-on Software License to enable IoT functionality on LIOB-585/586/587/588/589/59x, LIOB-AIR, and LINX-102/103/202/203
L-TEMP2	External temperature sensor (NTC10K) for use with L-IOB Universal Inputs
LENO-800	EnOcean Interface 868 MHz Europe
LENO-801	EnOcean Interface 902 MHz USA/Canada
LENO-802	EnOcean Interface 928 MHz Japan
LWLAN-800	Wireless LAN Interface IEEE 802.11bgn
LTE-800	LTE Interface
LSTAT-800-G3-Lx	Room Operator Panel, black front, white enclosure, Modbus, temperature, rel. humidity, ext. switch/NTC, IR receiver, Buttons (Lx)
LSTAT-801-G3-Lx	Room Operator Panel, front black, white enclosure, Modbus, temperature, rel. humidity, ext. switch/NTC, occupancy, IR receiver, Buttons (Lx)
LSTAT-802-G3-Lx	Room Operator Panel, front black, white enclosure, Modbus, temperature, rel. humidity, ext. switch/NTC, occupancy, IR receiver, CO2, Buttons (Lx)
LSTAT-800-G3-L20x	Room Operator Panel, white front, white enclosure, Modbus, temperature, rel. humidity, ext. switch/NTC, IR receiver, Buttons (Lx)
LSTAT-801-G3-L20x	Room Operator Panel, white front, white enclosure, Modbus, temperature, rel. humidity, ext. switch/NTC, occupancy, IR receiver, Buttons (Lx)
LSTAT-802-G3-L20x	Room Operator Panel, white front, white enclosure, Modbus, temperature, rel. humidity, ext. switch/NTC, occupancy, IR receiver, CO2, Buttons (Lx)
LSTAT-80x-CUSTOM	One-time customization cost for L-STAT custom design, including 2 working samples

- ✓ BACnet
- ✓ CEA-709
- KNX
- ✓ Modbus
- ✓ MP-Bus
- ✓ OPC



Datasheet #89080925



LIOB-595 I/O Controllers are IP-enabled, compact, programmable BACnet Building Controller (B-BC) with physical inputs and outputs and integrated graphical visualization.

Communication

LIOB-595 I/O Controllers are equipped with two Ethernet ports including a built-in Ethernet switch. This allows for building a daisy chained line topology of up to 20 devices, which reduces costs for network installation. Dual Ethernet port devices also allow the setup of a redundant Ethernet installation (ring topology), which increases reliability. The redundant Ethernet topology is enabled by the Rapid Spanning Tree Protocol (RSTP), which is supported by most managed switches.

Technology data points are automatically exposed as OPC tags for higher level OPC client applications or L-WEB system via the integrated OPC server providing TSL encrypted web services (OPC XML-DA) or UA Secure Conversation (OPC UA). The L-IOB I/O Controllers further allow data exchange over global connections (network-wide data exchange), offer AST™ functions (Alarming, Scheduling, and Trending), store custom graphic pages for visualization in LWEB-802/803, and can be seamlessly integrated in the LWEB-900 Building Management System. The L-IOB I/O Controllers implement the BACnet Building Controller (B-BC) profile and are BTL certified.

IoT Integration

The IoT function (Node.js) allows connecting the system to almost any cloud service, either for uploading historical data to analytics services, telemetry using MQTT, delivering alarm messages to alarm processing services or operating parts of the control system over a cloud service (e.g., scheduling based on Web calendars or booking systems). Processing Internet information such as weather data in forecast-based control is also possible. Finally, the JavaScript kernel also allows implementing serial protocols to non-standard equipment in primary plant control.

Local Operation and Override

All L-IOB I/O Controllers are equipped with an LCD display (128x64) with backlight and jog dial for manual local operation and override. Device and data point information is displayed in text form and via graphical symbols.

Unitary and Terminal Controller

The LIOB-595 is designed to efficiently implement unitary and terminal applications in a compact form factor. The integrated differential pressure sensor, its local I/O, and the built-in MP-Bus port provide connectivity for all unitary and terminal equipment. In addition, the RS-485 port allows connection of L-STAT room operator panels for temperature and air quality measurement and user interaction.

Features

- Automation station with physical inputs and outputs
- Programmable with L-STUDIO IEC 61131-3 and IEC 61499
- Room controller for up to 2 room segments
- 128x64 graphic display with backlight
- Local and remote access to information about device status and data points
- Manual operation using the jog dial or VNC client
- Alarming, Scheduling, and Trending (AST™)
- Node.js support¹ for easy IoT integration (e.g. Google calendar, MQTT, Alexa & friends, multimedia equipment,...)
- Event-driven e-mail and SMS (requires LTE-800) notification
- Math objects to execute mathematical operations on data points
- Stores customized graphic pages
- Visualization of customized graphic pages through LWEB-900 (Building Management), LWEB-803 (Monitoring and Control), or LWEB-802 (Web Browser)
- Support of the L-STAT Room Operator Panel
- Built-in OPC XML-DA and OPC UA server
- Dual Ethernet/IP interface
- Access to network statistics
- Compliant with ANSI/ASHRAE 135-2012 and ISO 16484-5:2012 standard

¹ requires L-IOT1 software license

L-IOB I/O Controller

LIOB-595

- Supports BACnet MS/TP, BACnet/IP or BACnet/SC
- BACnet Client Function (Write Property, Read Property, COV Subscription)
- BACnet Client Configuration with configuration tool (scan and EDE import)
- B-BC (BACnet Building Controller) functionality, BTL certified
- Compliant with CEA-709, CEA-852, and ISO/IEC 14908 Standard (LonMark System)
- Supports IP-852 (Ethernet/ IP)
- Support of dynamically created or static NVs
- Support of user-defined NVs (UNVTs) and Configuration Properties (SCPTs, UCPTs)
- Integrated BACnet/IP to BACnet/SC and BACnet MS/TP Router including BBMD as well as Slave-Proxy functionality
- Gateway functions including Smart Auto-Connect™
- Integrated web server for device configuration and monitoring data points
- Connection to EnOcean wireless devices via LENO-80x Interface
- Supports WLAN through LWLAN-800 Interface
- Supports LTE through LTE-800 Interface
- Support of the L-STAT Room Operator Panel
- Stores user-defined project documentation
- Integration of damper actuator via MP-Bus
- Differential pressure sensor
- 6 x Universal I/O (U, I, R) ³
- Support VPN

General Specifications

Type	LIOB-595
Dimensions (mm)	107 x 100 x 75 (L x W x H), DIM077
Installation	DIN rail mounting following DIN 43880, top hat rail EN 50022
Purpose of control	Operating control
Construction of control	Independently mounted control
Feature of automatic action	Type 1
Operating conditions	0 °C to 50 °C, 10–90 % RH, noncondensing, degree of protection: IP40, IP20 (terminals), pollution degree 2
Power supply	24 VDC/ V AC SELV ±10 % via LPOW-2415B, or with an external power supply
Rated Impulse Voltage	2500 V
Program cycle time	Down to 10 ms
Interface	2 x Ethernet (100Base-T): Web services (OPC XML-DA, OPC UA), LonMark IP-852, BACnet/IP*, BACnet/SC* Modbus TCP (Master or Slave), HTTP, FTP, SSH, HTTPS, Firewall, VNC, SNMP, VPN 2 x USB-A: WLAN (needs LWLAN-800), EnOcean (needs LENO-80x), LTE (needs LTE-800) 1 x RS-485 (ANSI TIA/EIA-485): BACnet MS/TP* or Modbus RTU (Master or Slave) or L-STAT (Room Operator Panels) 1 x MP-Bus * Router between BACnet/IP, BACnet/SC and BACnet MS/TP
Max. number of Rooms/Segments	2

Specifications

Type	LIOB-595
Power consumption	4.5 W ²
Universal I/O (IO)	6 x Universal I/O (U, I, R) ³
Digital Output (DO)	4 (4 x Relay 2A, 24V)
Digital Output specification	Please refer to the " General Input and Output Specification of LOYTEC devices " for more details.
Differential Pressure Sensor	±500 Pa (14 Bit)

² Add external load: Sum of max. current drawn from all outputs x 24V + power drawn from USB connectors

³ U: 0-10V input or 0-10V output, I: 4-20 mA input, R: resistance measurement

Resource limits			
Total number of data points	10 000	LonMark Calendars	1 (25 calendar patterns)
OPC data points	5 000	LonMark Schedulers	10
BACnet objects	500 (analog, binary, multi-state)	LonMark Alarm Servers	1
BACnet client mappings	500	E-mail templates	50
BACnet calendar objects	25	Math objects	50
BACnet scheduler objects	10 (64 data points per object)	Alarm logs	10
BACnet notification classes	32	Modbus data points	300
Trend logs (BACnet or generic)	256 (13 000 000 entries, ≈ 200 MB)	Connections (Local / Global)	500 / 100
Total trended data points	256	Number of L-WEB clients	32 (simultaneously)
CEA-709 network variables (NVs)	500	L-STAT Room Operator Panels	8
CEA-709 Alias NVs	500	EnOcean devices	10
CEA-709 External NVs (polling)	500	EnOcean data points	100
CEA-709 address table entries	256 (non-ECS mode: 15)	MP-Bus devices (per channel)	8 (16 MPL)

Runtime licenses	
Type	LIOB-595
Programming, Tools	L-STUDIO software (IEC 61131-3 or IEC 61499), L-INX Configurator
License	L-STUDIO: included

Order number	Product description
LIOB-595	L-IOB I/O Controller: 6 x Universal I/O (U, I, R), 4 DO (4 x Relay 2A, 24V), 1 Pressure Sensor
L-STUDIO	Development and integration platform for programmable LOYTEC controllers
L-ACT101-MP	Actuator 5/8", 5 Nm, 45in-lb, MP-Bus cable
L-ACT102-MP	Actuator 3/4", 5 Nm, 45in-lb, MP-Bus cable
LPOW-2415B	Power supply unit with power connector 24 VDC, 15 W
L-IOT1	Add-on Software License to enable IoT functionality on LIOB-585/586/587/588/589/59x, LIOB-AIR, and LINX-102/103/202/203
L-TEMP2	External temperature sensor (NTC10K) for use with L-IOB Universal Inputs
LENO-800	EnOcean Interface 868 MHz Europe
LENO-801	EnOcean Interface 902 MHz USA/Canada
LENO-802	EnOcean Interface 928 MHz Japan
LWLAN-800	Wireless LAN Interface IEEE 802.11bgn
LTE-800	LTE Interface
LSTAT-800-G3-Lx	Room Operator Panel, black front, white enclosure, Modbus, temperature, rel. humidity, ext. switch/NTC, IR receiver, Buttons (Lx)
LSTAT-801-G3-Lx	Room Operator Panel, front black, white enclosure, Modbus, temperature, rel. humidity, ext. switch/NTC, occupancy, IR receiver, Buttons (Lx)
LSTAT-802-G3-Lx	Room Operator Panel, front black, white enclosure, Modbus, temperature, rel. humidity, ext. switch/NTC, occupancy, IR receiver, CO2, Buttons (Lx)
LSTAT-800-G3-L20x	Room Operator Panel, white front, white enclosure, Modbus, temperature, rel. humidity, ext. switch/NTC, IR receiver, Buttons (Lx)
LSTAT-801-G3-L20x	Room Operator Panel, white front, white enclosure, Modbus, temperature, rel. humidity, ext. switch/NTC, occupancy, IR receiver, Buttons (Lx)
LSTAT-802-G3-L20x	Room Operator Panel, white front, white enclosure, Modbus, temperature, rel. humidity, ext. switch/NTC, occupancy, IR receiver, CO2, Buttons (Lx)
LSTAT-80x-CUSTOM	One-time customization cost for L-STAT custom design, including 2 working samples

L-IOB I/O Controller

LIOB-596

Datasheet #89081725



- ✓ BACnet
- ✓ Modbus
- ✓ CEA-709
- ✓ MP-Bus
- KNX
- ✓ OPC



LIOB-596 I/O Controllers are IP-enabled, compact, programmable BACnet Building Controller (B-BC) with physical inputs and outputs and integrated graphical visualization.

Communication

LIOB-596 I/O Controllers are equipped with two Ethernet ports including a built-in Ethernet switch. This allows for building a daisy chained line topology of up to 20 devices, which reduces costs for network installation. Dual Ethernet port devices also allow the setup of a redundant Ethernet installation (ring topology), which increases reliability. The redundant Ethernet topology is enabled by the Rapid Spanning Tree Protocol (RSTP), which is supported by most managed switches.

Technology data points are automatically exposed as OPC tags for higher level OPC client applications or L-WEB system via the integrated OPC server providing TSL encrypted web services (OPC XML-DA) or UA Secure Conversation (OPC UA). The L-IOB I/O Controllers further allow data exchange over global connections (network-wide data exchange), offer AST™ functions (Alarming, Scheduling, and Trending), store custom graphic pages for visualization in LWEB-802/803, and can be seamlessly integrated in the LWEB-900 Building Management System. The L-IOB I/O Controllers implement the BACnet Building Controller (B-BC) profile and are BTL certified.

IoT Integration

The IoT function (Node.js) allows connecting the system to almost any cloud service, either for uploading historical data to analytics services, telemetry using MQTT, delivering alarm messages to alarm processing services or operating parts of the control system over a cloud service (e.g., scheduling based on Web calendars or booking systems). Processing Internet information such as weather data in forecast-based control is also possible. Finally, the JavaScript kernel also allows implementing serial protocols to non-standard equipment in primary plant control.

Local Operation and Override

All L-IOB I/O Controllers are equipped with an LCD display (128x64) with backlight and jog dial for manual local operation and override. Device and data point information is displayed in text form and via graphical symbols.

Features

- Automation station with physical inputs and outputs
- Math objects to execute mathematical operations on data points
- Programmable with L-STUDIO IEC 61131-3 and IEC 61499
- Stores customized graphic pages
- Room controller for up to 2 room segments
- Visualization of customized graphic pages through LWEB-900 (Building Management), LWEB-803 (Monitoring and Control), or LWEB-802 (Web Browser)
- 128x64 graphic display with backlight
- Support of the L-STAT Room Operator Panel
- Local and remote access to information about device status and data points
- Built-in OPC XML-DA and OPC UA server
- Manual operation using the jog dial or VNC client
- Dual Ethernet/IP interface
- Alarming, Scheduling, and Trending (AST™)
- Access to network statistics
- Node.js support¹ for easy IoT integration (e.g. Google calendar, MQTT, Alexa & friends, multimedia equipment,...)
- Compliant with ANSI/ASHRAE 135-2012 and ISO 16484-5:2012 standard
- Event-driven e-mail and SMS (requires LTE-800) notification

¹ requires L-IOT1 software license

- Supports BACnet MS/TP, BACnet/IP or BACnet/SC
- BACnet Client Function (Write Property, Read Property, COV Subscription)
- BACnet Client Configuration with configuration tool (scan and EDE import)
- B-BC (BACnet Building Controller) functionality, BTL certified
- Compliant with CEA-709, CEA-852, and ISO/IEC 14908 Standard (LonMark System)
- Supports IP-852 (Ethernet/ IP)
- Support of dynamically created or static NVs
- Support of user-defined NVs (UNVTs) and Configuration Properties (SCPTs, UCPTs)
- Integrated BACnet/IP to BACnet/SC and BACnet MS/TP Router including BBMD as well as Slave-Proxy functionality
- Gateway functions including Smart Auto-Connect™
- Integrated web server for device configuration and monitoring data points
- Connection to EnOcean wireless devices via LENO-80x Interface
- Supports WLAN through LWLAN-800 Interface
- Supports LTE through LTE-800 Interface
- Support of the L-STAT Room Operator Panel
- Stores user-defined project documentation
- Integration of damper actuator via MP-Bus
- 8 x Universal I/O (U, I, R) ³
- Support VPN

General Specifications

Type	LIOB-596
Dimensions (mm)	107 x 100 x 75 (L x W x H), DIM078
Installation	DIN rail mounting following DIN 43880, top hat rail EN 50022
Purpose of control	Operating control
Construction of control	Independently mounted control
Feature of automatic action	Type 1
Operating conditions	0 °C to 50 °C, 10–90 % RH, noncondensing, degree of protection: IP40, IP20 (terminals), pollution degree 2
Power supply	24 VDC/ VAC SELV ±10 % via LPOW-2415B, or with an external power supply
Rated Impulse Voltage	2500 V
Program cycle time	Down to 10 ms
Interface	2 x Ethernet (100Base-T): Web services (OPC XML-DA, OPC UA), LonMark IP-852, BACnet/IP*, BACnet/SC* Modbus TCP (Master or Slave), HTTP, FTP, SSH, HTTPS, Firewall, VNC, SNMP, VPN 2 x USB-A: WLAN (needs LWLAN-800), EnOcean (needs LENO-80x), LTE (needs LTE-800) 1 x RS-485 (ANSI TIA/EIA-485): BACnet MS/TP* or Modbus RTU (Master or Slave) or L-STAT (Room Operator Panels) 1 x MP-Bus * Router between BACnet/IP, BACnet/SC and BACnet MS/TP
Max. number of Rooms/Segments	2

Specifications

Type	LIOB-596
Power consumption	4.5 W ²
Universal I/O (IO)	8 x Universal I/O (U, I, R) ³
Digital Output (DO)	6 (4 x Relay 2A, 24V; 2 x TRIAC 0.5A)
Digital Output specification	Please refer to the " General Input and Output Specification of LOYTEC devices " for more details.

² Add external load: Sum of max. current drawn from all outputs x 24V + power drawn from USB connectors

³ U: 0-10V input or 0-10V output, I: 4-20 mA input, R: resistance measurement

LIOB-596

Resource limits			
Total number of data points	10 000	LonMark Calendars	1 (25 calendar patterns)
OPC data points	5 000	LonMark Schedulers	10
BACnet objects	500 (analog, binary, multi-state)	LonMark Alarm Servers	1
BACnet client mappings	500	E-mail templates	50
BACnet calendar objects	25	Math objects	50
BACnet scheduler objects	10 (64 data points per object)	Alarm logs	10
BACnet notification classes	32	Modbus data points	300
Trend logs (BACnet or generic)	256 (13 000 000 entries, ≈ 200 MB)	Connections (Local / Global)	500 / 100
Total trended data points	256	Number of L-WEB clients	32 (simultaneously)
CEA-709 network variables (NVs)	500	L-STAT Room Operator Panels	8
CEA-709 Alias NVs	500	EnOcean devices	10
CEA-709 External NVs (polling)	500	EnOcean data points	100
CEA-709 address table entries	256 (non-ECS mode: 15)	MP-Bus devices (per channel)	8 (16 MPL)

Runtime licenses	
Type	LIOB-596
Programming, Tools	L-STUDIO software (IEC 61131-3 or IEC 61499), L-INX Configurator
License	L-STUDIO: included

Order number	Product description
LIOB-596	L-IOB I/O Controller: 8 x Universal I/O (U, I, R), 6 DO (4 x Relay 2A, 24V; 2 x TRIAC 0.5A)
L-STUDIO	Development and integration platform for programmable LOYTEC controllers
L-ACT101-MP	Actuator 5/8", 5 Nm, 45in-lb, MP-Bus cable
L-ACT102-MP	Actuator 3/4", 5 Nm, 45in-lb, MP-Bus cable
LPOW-2415B	Power supply unit with power connector 24 VDC, 15 W
L-IOT1	Add-on Software License to enable IoT functionality on LIOB-585/586/587/588/589/59x, LIOB-AIR, and LINX-102/103/202/203
L-TEMP2	External temperature sensor (NTC10K) for use with L-IOB Universal Inputs
LENO-800	EnOcean Interface 868 MHz Europe
LENO-801	EnOcean Interface 902 MHz USA/Canada
LENO-802	EnOcean Interface 928 MHz Japan
LWLAN-800	Wireless LAN Interface IEEE 802.11bgn
LTE-800	LTE Interface
LSTAT-800-G3-Lx	Room Operator Panel, black front, white enclosure, Modbus, temperature, rel. humidity, ext. switch/NTC, IR receiver, Buttons (Lx)
LSTAT-801-G3-Lx	Room Operator Panel, front black, white enclosure, Modbus, temperature, rel. humidity, ext. switch/NTC, occupancy, IR receiver, Buttons (Lx)
LSTAT-802-G3-Lx	Room Operator Panel, front black, white enclosure, Modbus, temperature, rel. humidity, ext. switch/NTC, occupancy, IR receiver, CO2, Buttons (Lx)
LSTAT-800-G3-L20x	Room Operator Panel, white front, white enclosure, Modbus, temperature, rel. humidity, ext. switch/NTC, IR receiver, Buttons (Lx)
LSTAT-801-G3-L20x	Room Operator Panel, white front, white enclosure, Modbus, temperature, rel. humidity, ext. switch/NTC, occupancy, IR receiver, Buttons (Lx)
LSTAT-802-G3-L20x	Room Operator Panel, white front, white enclosure, Modbus, temperature, rel. humidity, ext. switch/NTC, occupancy, IR receiver, CO2, Buttons (Lx)
LSTAT-80x-CUSTOM	One-time customization cost for L-STAT custom design, including 2 working samples

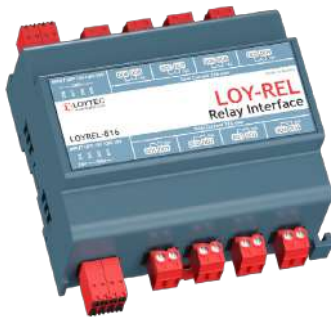

The LOYREL-816 is a relay interface containing eight 16 A relays that are controlled by eight 0/10 V outputs on a L-IOB, LROC-400 or LROC-402.

Features

- Relay Interface for L-IOB, LROC-400 or LROC-402
- Controls up to eight 16 A relays using 0/10 V inputs
- Up to 64 A total current.

Specifications

Dimensions (mm)	107 x 100 x 60 (L x W x H), DIM079
Installation	DIN rail mounting following DIN 43880, top hat rail EN 50022
Power supply	24 V DC
Power consumption	up to 3.2 W
Operating conditions	0 °C to 50 °C, 10–90 % RH, noncondensing, degree of protection: IP40, IP20 (terminals)
Interfaces	8 x Digital Output (16 A Relays) 8 x Digital Input (0/10 V), input 0 V: Relay off, Input 10 V: Relay on
For use with	L-IOB, LROC-400 or LROC-402

Wiring example:

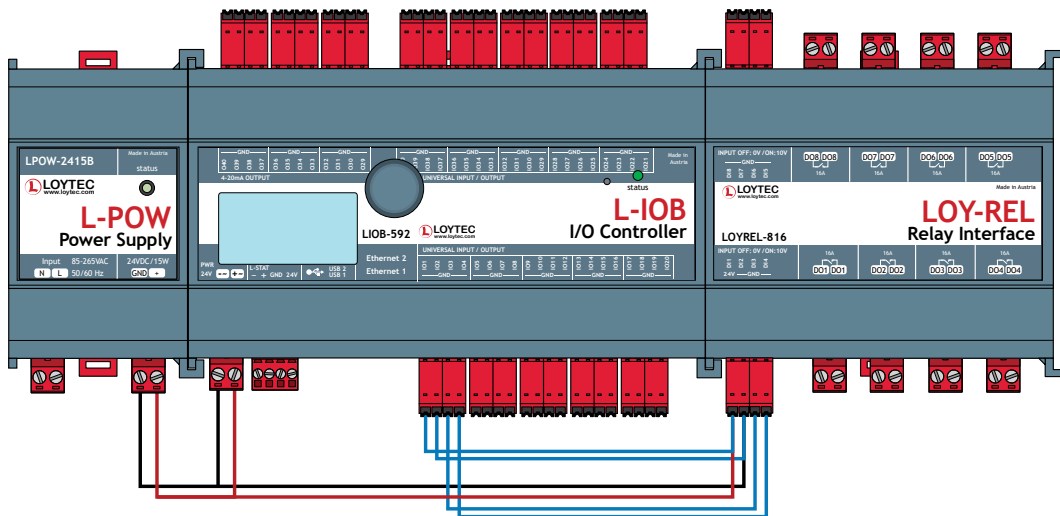

Order number	Product description
LOYREL-816	Relay interface, 8 x Digital Output 16 A Relays, 8 x Digital Input 0/10 V

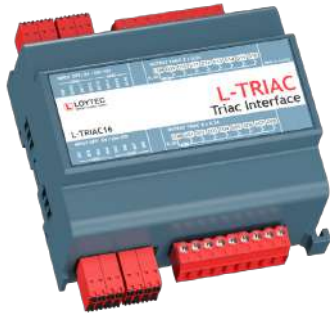

The L-TRIAC16 is a TRIAC interface containing 16 0.5 A TRIACS that are controlled by 16 0/10 V outputs on a L-IOB, LROC-400 or LROC-402.

Features

- TRIAC interface for L-IOB, LROC-400 or LROC-402
- Controls up to 16 0.5 A TRIACS using 0/10 V inputs
- Up to 8 A total current

Specifications

Dimensions (mm)	107 x 100 x 60 (L x W x H), DIM080
Installation	DIN rail mounting following DIN 43880, top hat rail EN 50022
Operating conditions	0 °C to 50 °C, 10 – 90 % RH, noncondensing, degree of protection: IP40, IP20 (terminals)
Interfaces	16 x Digital Output (0.5 A TRIAC), 24 V AC - 240 V AC 16 x Digital Input (0/10 V), Input 0 V: TRIAC off, Input 10 V: TRIAC on
For use with	L-IOB, LROC-400 or LROC-402

Wiring example:

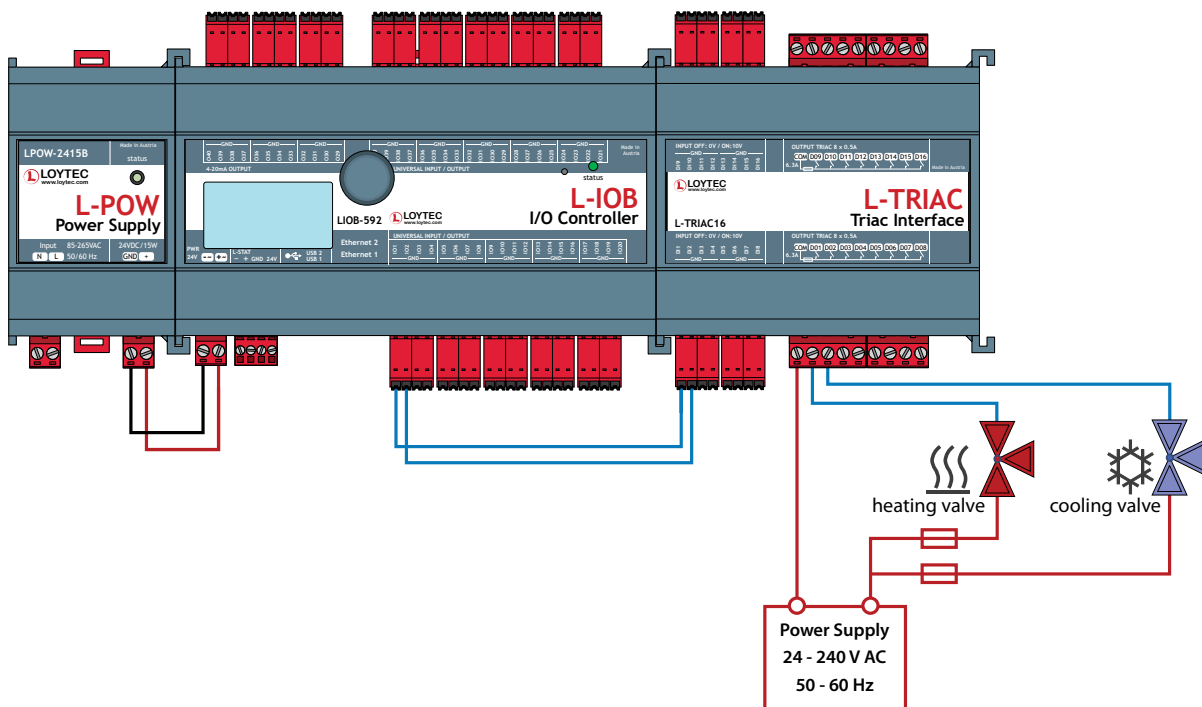

Order number	Product description
L-TRIAC16	TRIAC Interface, 16 x Digital Output 0.5 A TRIAC, 16 x Digital Input (0/10 V)



The LOYCNV-VA8 is a voltage to current converter interface containing eight 4-20 mA current outputs that are controlled by eight 0-10 V outputs of a L-IOB, LROC-400 or LROC-402.

Features

- Voltage/Current interface for L-IOB, LROC-400 or LROC-402
- Controls up to eight 4-20 mA outputs using 0-10 V input signals

Specifications

Dimensions (mm)	55 x 100 x 60 (L x W x H), DIM081
Installation	DIN rail mounting following DIN 43880, top hat rail EN 50022
Power supply	24 V DC $\pm 10\%$
Power consumption	max. 4 W (0.5 W per channel)
Operating conditions	0 °C to 50 °C, 10 – 90 % RH, noncondensing, degree of protection: IP40, IP20 (terminals)
Interfaces	8 x Analog Input (0-10 V) 8 x Analog Output (4-20 mA), burden resistance 250-500 Ohm
For use with	L-IOB, LROC-400 or LROC-402

Wiring example:

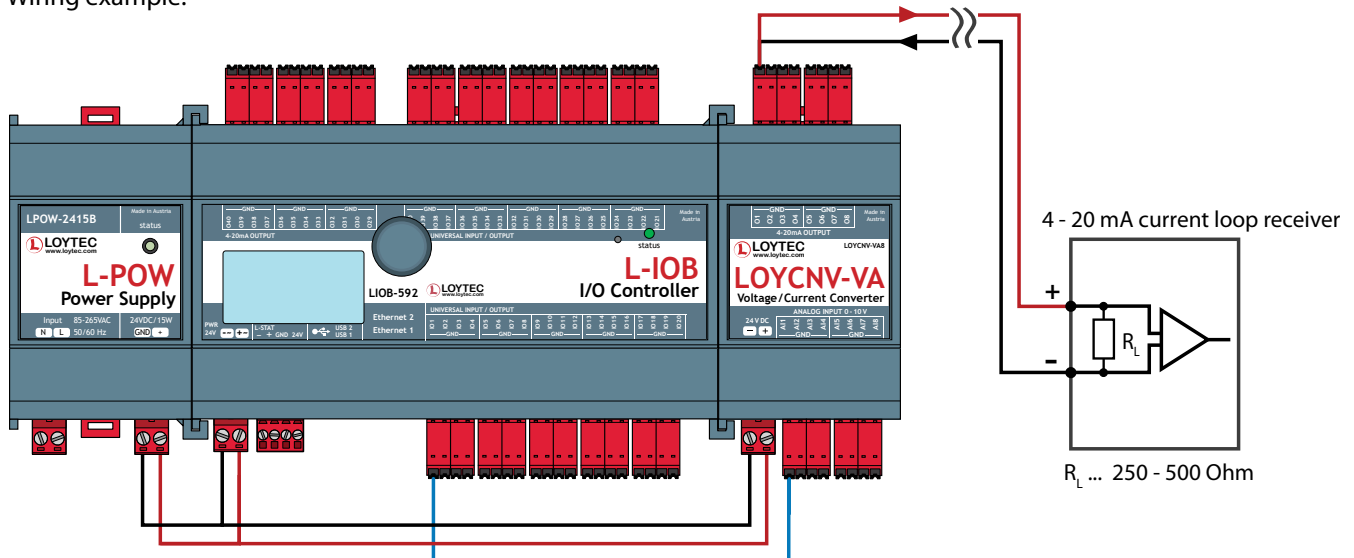

Order number	Product description
LOYCNV-VA8	Voltage / Current Converter, 8 channels, 0-10 V input to 4-20 mA output converter

Voltage Converter

LOYCNV-PT1008

Datasheet #89090301

BACnet
CEA-709
KNX

Modbus
M-Bus
OPC



The LOYCNV-PT1008 is a PT1000 to 0-10V interface containing eight channels for resistance to voltage conversion on devices with IOs or UIs (e.g. L-IOB, LROC-40x, ...)

Features

- PT1000 interface for L-IOB, LROC-40x, ...
- Converts up to eight PT1000 sensors in 2-wire connection (common GND)

Specifications

Dimensions (mm)	55 x 100 x 60 (L x W x H), DIM086
Installation	DIN rail mounting following DIN 43880, top hat rail EN 50022
Power supply	24 V DC \pm 10 %
Power consumption	approx. 0.7 W
Operating conditions	0 °C to 50 °C, 10 – 90 % RH, noncondensing, degree of protection: IP40, IP20 (terminals)
Input	8x PT1000 (2-wire connection)
Output	8x 0 – 10 V
Conversion range	-60 – 100 °C
For use with	L-IOB, LROC-40x, ...

In conjunction with bidirectional L-IOB IO terminals

Typ. accuracy	\pm 0.2 K
Max. error	\pm (0.8 K + max. 0.4% of range)
Resolution	0.04 K
Temperature coefficient	10 ppm/K of range

Order number	Product description
LOYCNV-PT1008	8x PT1000 to 0-10 V converter

L-IOB I/O Modules

The L-IOB I/O Module family of products consists of intelligent input/output devices featuring various I/O configurations. Based on LOYTEC's 32-bit L-CORE platform, the L-IOB I/O Modules provide first class performance for a wide area of applications.

Plug and play installation

The L-IOB I/O Modules can be used as I/O extensions for L-INX Automation Servers, L-ROC Room Controllers, L-IOB I/O Controllers. The connection is done via gold-plated contacts on the side (LIOB-Connect), twisted pair (LIOB-FT), or Ethernet/IP (LIOB-IP852 or LIOB-BIP), depending on the L-IOB model.

LonMark Models

The LIOB-15x I/O Modules and LIOB-45x I/O Modules are LonMark certified I/O nodes which communicate in the LonMark system via network variables over TP/FT-10 or Ethernet/IP-852 respectively.

BACnet/IP Models

The LIOB-55x I/O Modules adhere to the BACnet Building Controller Profile (B-BC) and communicate over Ethernet/IP in the BACnet/IP network. The I/O data points can either be exposed through BACnet server objects or actively fetched from a BACnet server via BACnet client maps on the L-IOB I/O Modules.

L-IOB I/O Modules

L-IOB I/O Module

LIOB-Connect

LIOB-100

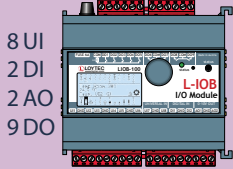

LIOB-101

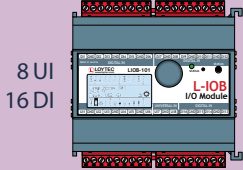

LIOB-102

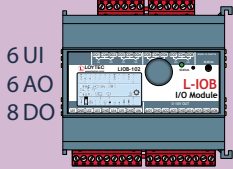

LIOB-103

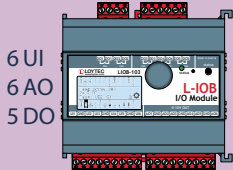

LIOB-110

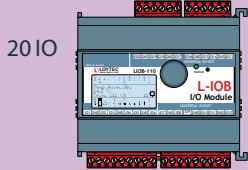

LIOB-112

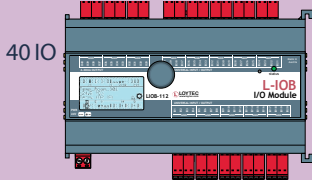

LIOB-A2/A4/A5

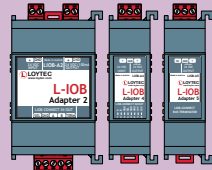

LonMark TP/FT-10

LIOB-150



LIOB-151

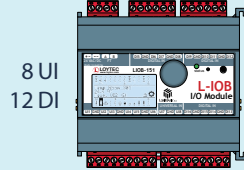

LIOB-152



LIOB-153

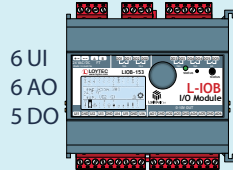

LIOB-154



LonMark IP-852

LIOB-450



LIOB-451

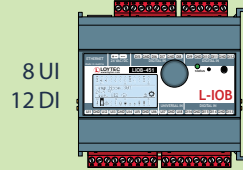

LIOB-452



LIOB-453



LIOB-454

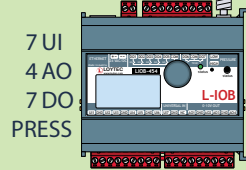

BACnet/IP

LIOB-550



LIOB-551

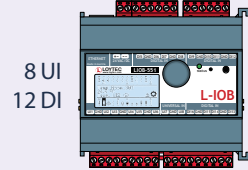

LIOB-552



LIOB-553



LIOB-554

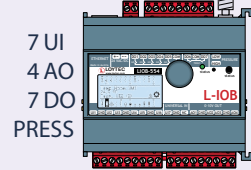

LIOB-560

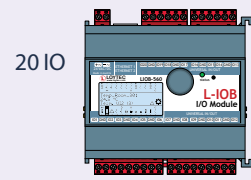

LIOB-562

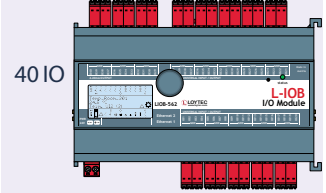

Functions

L-WEB, L-STUDIO

L-ROC

L-INOX

L-IOB

Gateways

LPAD-7,
L-VIS, L-STAT

L-DALI

Routers, NIC

Interfaces

Accessories

LIOB-100/101/102/103/110/112 V2

Datasheet #89018322



LIOB-10x/11x I/O Modules extend L-INX Automation Servers, L-ROC Room Controllers, and LIOB-586/587/588/589 I/O Controllers with physical inputs, outputs or bidirectional I/Os. Several models with different I/O configurations are available.

LIOB-Connect

The LIOB-10x/11x Modules have gold-plated connectors (LIOB-Connect) to string multiple devices together and connect them to the L-INX, L-ROC or LIOB-586/587/588/589. These controllers automatically recognize the LIOB-10x/11x I/O Modules and provide the resulting data points.

Local Operation and Override

All L-IOB I/O Modules are equipped with an LCD display (128x64) with backlight and jog dial for manual local operation. Device and data point information is displayed in text form and via graphical symbols.

Features

- I/O module with physical inputs, outputs or bidirectional I/Os configurable as either input or output
- Connected to L-INX Automation Server, L-ROC Room Controller, or LIOB-586/587/588/589 via LIOB-Connect
- Manual operation using the jog dial
- 128x64 graphic display with backlight
- Local access to information about device status and data points in clear text and symbols
- Automatic integration into device configurations with L-INX, L-ROC, and LIOB-586/587/588/589
- Easy device replacement without any additional software

General Specifications

Type	LIOB-100	LIOB-101	LIOB-102	LIOB-103	LIOB-110	LIOB-112
Dimensions (mm)	107 x 100 x 75 (L x W x H), DIM011, DIM012, DIM013, DIM014, DIM062					159 x 100 x 75 (L x W x H), DIM073
Installation	DIN rail mounting following DIN 43880, top hat rail EN 50022					
Operating conditions	0 °C to 50 °C, 10 – 90 % RH, noncondensing, degree of protection: IP40, IP20 (terminals)					
Power supply	24 V DC / 24 V AC ±10 % via L-INX, L-ROC, LIOB-586/587/588/589, L-POW or LIOB-A2/A4 via LIOB-Connect					
Interfaces	1 x LIOB-Connect					

Specifications LIOB-Connect

Type	LIOB-100	LIOB-101	LIOB-102	LIOB-103	LIOB-110	LIOB-112
Installation	Attachable (max. 4 modules) or connected with a 4-wire cable, max. 50 m					
Power consumption	1.7 W 2.6 W (Relays on)	1.7 W	1.7 W 2.7 W (Relays on)	1.7 W 2.5 W (Relays on)	2.5 W	2.5 W + 0.5 W for each Oxx (max 6 W)
Universal Input (UI)	8	8	6	6	-	-
Digital Input (DI)	2	16	-	-	-	-
Analog Output (AO)	2	-	6	6	-	-
Digital Output (DO)	9 (5 x Relay 6 A, 4 x Triac 0.5 A)	-	8 (8 x Relay 6 A)	5 (5 x Relay 6 A)	-	-
Universal I/O (IO)	-	-	-	-	20	40*
Certificates	UL	UL	UL	UL	UL pend.	UL pend.
Digital Output specification	Please refer to the "General Input and Output Specification of LOYTEC devices" at the end of the L-IOB section for more details.					

* O29-O40 are internally connected to IO29-IO40 and provide 4-20 mA outputs in parallel to the 0-10 V outputs on IO29-IO40

Functions
L-WEB, L-STUDIO
L-ROC
L-INX
L-IOB
Gateways
LPAD-7, L-VIS, L-STAT
L-DALI
Routers, NIC
Interfaces
Accessories

LIOB-100/101/102/103/110/112 V2

Order number	Product description
LIOB-100	LIOB-Connect I/O Module: 8 UI, 2 DI, 2 AO, 9 DO (5 x Relay 6 A, 4 x Triac 0.5 A)
LIOB-101	LIOB-Connect I/O Module: 8 UI, 16 DI
LIOB-102	LIOB-Connect I/O Module: 6 UI, 6 AO, 8 DO (8 x Relay 6 A)
LIOB-103	LIOB-Connect I/O Module: 6 UI, 6 AO, 5 DO (5 x Relay 16 A)
LIOB-110	LIOB-Connect I/O Module: 20 Universal I/O (IO)
LIOB-112	LIOB-Connect I/O Module: 40 Universal I/O (12 optionally with 4-20 mA Current Output)
LIOB-A2	L-IOB Adapter 2 to split the LIOB-Connect bus using 4-wire cables
LIOB-A4	L-IOB Adapter 4 to split the LIOB-Connect bus using RJ45 network cables
LIOB-A5	L-IOB Adapter 5 to terminate the LIOB-Connect bus
LPOW-2415A	LIOB-Connect power supply unit, 24 VDC, 15 W
LPOW-2415B	Power supply unit with power connector 24 VDC, 15 W
LPOW-2460B	Power supply unit with power connector 24 VDC, 60 W
L-TEMP2	External temperature sensor (NTC10K) for use with L-IOB Universal Inputs

LIOB-FT I/O Module

LIOB-150/151/152/153/154 V2

BACnet
✓ CEA-709
KNX

Modbus
M-Bus
OPC

Datasheet #89019923



The LIOB-15x Modules are LonMark certified and communicate over TP/FT-10 in the LonMark System. They provide up to 512 address table entries (ECS mode) which eliminates all binding restrictions.

LIOB-FT mode

The LIOB-15x Modules can be switched to LIOB-FT mode using manual local operation. In LIOB-FT mode, the LIOB-15x Modules extend L-INX Automation Servers and L-ROC Room Controllers with physical inputs and outputs via plug and play.

Local Operation and Override

All L-IOB I/O Modules are equipped with an LCD display (128x64) with backlight and jog dial for manual local operation. Device and data point information is displayed in text form and via graphical symbols.

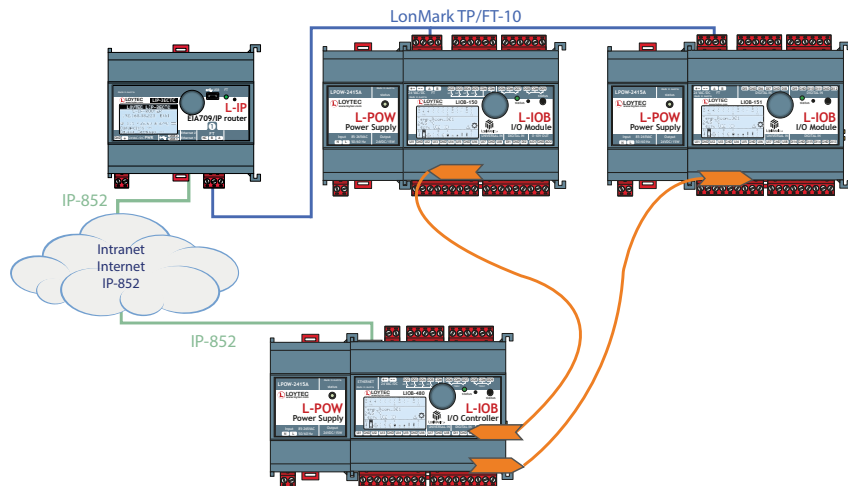

Features

- I/O module with physical inputs and outputs
- SNVT-based interface for integration on the LonMark TP/FT-10 channel
- LonMark certified
- Manual operation using the jog dial
- 128x64 graphic display with backlight
- Local access to information about device status and data points in clear text and symbols
- Compliant with CEA-709 and ISO/IEC 14908-2 standard (LonMark System)
- Connected to the L-INX Automation Server or L-ROC Room Controller via LIOB-FT
- Automatic integration into device configurations with L-INX and L-ROC
- Easy device replacement without any additional software
- LNS plug-in for device configuration in the LonMark System

LIOB-150/151/152/153/154 V2

General Specifications	
Dimensions (mm)	107 x 100 x 75 (L x W x H), DIM015, DIM016, DIM017
Installation	DIN rail mounting following DIN 43880, top hat rail EN 50022
Operating conditions	0 °C to 50 °C, 10–90 % RH, noncondensing, degree of protection: IP40, IP20 (terminals)
Power supply	24 VDC / 24 VAC ±10 % via L-INX, L-ROC, L-POW or LIOB-A2/A4 via LIOB-Connect
Interface	1 x LonMark TP/FT-10 or LIOB-FT

Specifications LIOB-FT I/O Module (LIOB-15x)					
Type	LIOB-150	LIOB-151	LIOB-152	LIOB-153	LIOB-154
Power consumption	1.7 W 2.6 W (Relays on)	1.7 W	1.7 W 2.7 W (Relays on)	1.7 W 2.5 W (Relays on)	1.7 W 2.6 W (Relays on)
Universal Input (UI)	8	8	6	6	7
Digital Input (DI)	2	12	-	-	-
Analog Output (AO)	2	-	6	6	4
Digital Output (DO)	8 (4 x Relay 6 A, 4 x Triac 0.5 A)	-	8 (8 x Relay 6 A)	5 (4 x Relay 16 A, 1 x Relay 6 A)	7 (5 x Relay 6 A, 2 x Triac 0.5 A)
Digital Output specification	Please refer to the " General Input and Output Specification of LOYTEC devices " at the end of the L-IOB section for more details.				
Differential Pressure Sensor	-	-	-	-	±500 Pa

Resource limits	
Network variables (NVs)	Fixed static NV interface
Address table entries	512 (non-ECS mode: 15)

Order number	Product description
LIOB-150	LIOB-FT I/O Module: 8 UI, 2 DI, 2 AO, 8 DO (4 x Relay 6 A, 4 x Triac 0.5 A)
LIOB-151	LIOB-FT I/O Module: 8 UI, 12 DI
LIOB-152	LIOB-FT I/O Module: 6 UI, 6 AO, 8 DO (8 x Relay 6 A)
LIOB-153	LIOB-FT I/O Module: 6 UI, 6 AO, 5 DO (4 x Relay 16 A, 1 x Relay 6 A)
LIOB-154	LIOB-FT I/O Module: 7 UI, 4 AO, 7 DO (5 x Relay 6 A, 2 x Triac 0.5 A), 1 Pressure Sensor
LPOW-2415A	LIOB-Connect power supply unit, 24 VDC, 15 W
LPOW-2415B	Power supply unit with power connector 24 VDC, 15 W
L-TEMP2	External temperature sensor (NTC10K) for use with L-IOB Universal Inputs

Datasheet #89026924

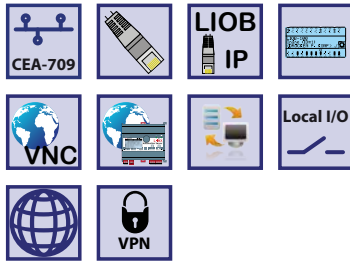

The LIOB-45x Modules are LonMark certified and communicate over Ethernet/IP-852 in the LonMark System. They provide up to 512 address table entries (ECS mode) which eliminates all binding restrictions.

LonMark IP-852 Channel over Ethernet

The LIOB-45x I/O Modules are equipped with two Ethernet ports including a built-in Ethernet switch. This allows for building a daisy chained line topology of up to 20 devices, which reduces costs for network installation. Dual Ethernet port devices also allow the setup of a redundant Ethernet installation (ring topology), which increases reliability. The redundant Ethernet topology is enabled by the Rapid Spanning Tree Protocol (RSTP), which is supported by most managed switches.

The LIOB-45x Modules are equipped with a web interface to query the device status. The local display can be accessed via VNC.

LIOB-IP Mode

The LIOB-45x Modules can be switched to LIOB-IP mode using manual local operation. In LIOB-IP mode, the LIOB-45x Modules extend L-INX Automation Servers, L-ROC Room Controllers, and L-IOB I/O Controllers with physical inputs and outputs via plug and play.

Local Operation and Override

All L-IOB I/O Modules are equipped with an LCD display (128x64) with backlight and jog dial for manual local operation. Device and data point information is displayed in text form and via graphical symbols.

L-INX I/O integration through LIOB-IP via plug and play

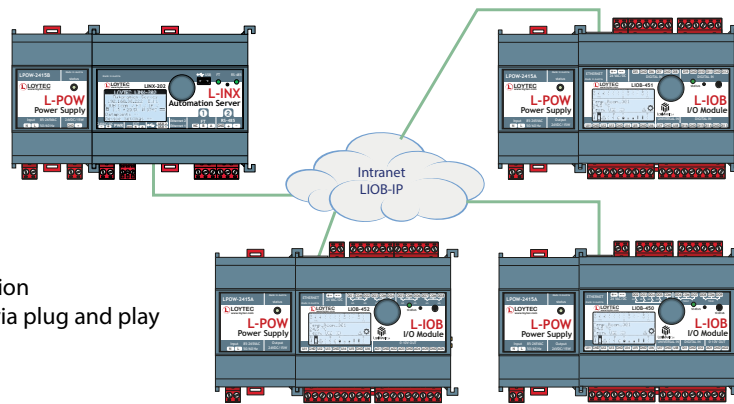

Features

- I/O module with physical inputs and outputs
- Dual Ethernet/IP interface
- SNVT-based interface for integration in the LonMark IP-852 channel
- LonMark certified
- Up to 512 address table entries (ECS mode)
- Manual operation using the jog dial or VNC client
- 128x64 graphic display with backlight
- Local access to information about device status and data points in clear text and symbols
- Connected to the L-INX Automation Server, L-ROC Room Controller, and L-IOB I/O Controller, via LIOB-IP
- Automatic integration into device configurations with L-INX, L-ROC, and L-IOB I/O Controller
- Easy device replacement without any additional software
- Integrated web server for device configuration
- LNS plug-in for device configuration in the LonMark System

LIQB-450/451/452/453/454 V2

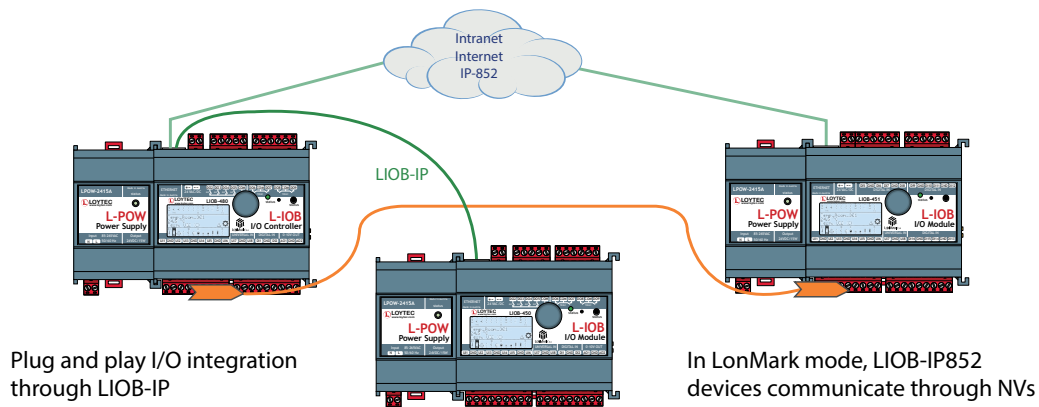

General Specifications

Dimensions (mm)	107 x 100 x 75 (L x W x H), DIM018, DIM019, DIM020, DIM021, DIM022
Installation	DIN rail mounting following DIN 43880, top hat rail EN 50022
Operating conditions	0 °C to 50 °C, 10 – 90 % RH, noncondensing, degree of protection: IP40, IP20 (terminals)
Power supply	24 VDC / 24 VAC ± 10 % via L-INX, L-ROC, L-POW or LIQB-A2/A4 via LIQB-Connect
Interface	2 x Ethernet (100Base-T): LIQB-IP, LonMark IP-852

Specifications LIQB-IP852 I/O Module (LIQB-45x)

Type	LIQB-450	LIQB-451	LIQB-452	LIQB-453	LIQB-454
Power consumption	4.5 W (Relays on)	4.5 W	4.5 W (Relays on)	4.5 W (Relays on)	4.5 W (Relays on)
Universal Input (UI)	8	8	6	6	7
Digital Input (DI)	2	12	-	-	-
Analog Output (AO)	2	-	6	6	4
Digital Output (DO)	8 (4 x Relay 6 A, 4 x Triac 0.5 A)	-	8 (8 x Relay 6 A)	5 (4 x Relay 16 A, 1 x Relay 6 A)	7 (5 x Relay 6 A, 2 x Triac 0.5 A)
Digital Output specification	Please refer to the "General Input and Output Specification of LOYTEC devices" at the end of the L-IQB section for more details.				
Differential Pressure Sensor	-	-	-	-	±500 Pa

Resource limits

Network variables (NVs)	Fixed static NV interface
Address table entries	512 (non-ECS mode: 15)

Order number	Product description
LIQB-450	LIQB-IP852 I/O Module: 8 UI, 2 DI, 2 AO, 8 DO (4 x Relay 6 A, 4 x Triac 0.5 A)
LIQB-451	LIQB-IP852 I/O Module: 8 UI, 12 DI
LIQB-452	LIQB-IP852 I/O Module: 6 UI, 6 AO, 8 DO (8 x Relay 6 A)
LIQB-453	LIQB-IP852 I/O Module: 6 UI, 6 AO, 5 DO (4 x Relay 16 A, 1 x Relay 6 A)
LIQB-454	LIQB-IP852 I/O Module: 7 UI, 4 AO, 7 DO (5 x Relay 6 A, 2 x Triac 0.5 A), 1 Pressure Sensor
LPOW-2415A	LIQB-Connect power supply unit, 24 VDC, 15 W
LPOW-2415B	Power supply unit with power connector 24 VDC, 15 W
L-TEMP2	External temperature sensor (NTC10K) for use with L-IQB Universal Inputs

LIOB-BIP I/O Module

LIOB-550/551/552/553/554 V2

Datasheet #89027124

✓ BACnet
CEA-709
KNX

Modbus
M-Bus
✓ OPC



The LIOB-55x Modules communicate over Ethernet/IP in the BACnet/IP and BACnet/SC network. They adhere to the BACnet Building Controller Profile (B-BC) and either expose their I/O data points through BACnet server objects or actively fetch them from a BACnet server via BACnet client maps.

According to the B-BC profile, the LIOB-55x Modules support BACnet alarming, scheduling, and trending. They are BTL tested and certified.

Communication

The LIOB-55x I/O Modules are equipped with two Ethernet ports including a built-in Ethernet switch. This allows for building a daisy chained line topology of up to 20 devices, which reduces costs for network installation. Dual Ethernet port devices also allow the setup of a redundant Ethernet installation (ring topology), which increases reliability. The redundant Ethernet topology is enabled by the Rapid Spanning Tree Protocol (RSTP), which is supported by most managed switches.

The LIOB-55x Modules are equipped with a web interface to query the device status and display or change each data point of the module. In addition to the BACnet object interface, the I/O data points are exposed by the integrated OPC server providing TSL encrypted web services (OPC XML-DA) or UA Secure Conversation (OPC UA). The local display can be accessed via VNC.

LIOB-IP Mode

The LIOB-55x Modules can be switched to LIOB-IP mode using manual local operation. In LIOB-IP mode, the LIOB-55x Modules extend L-INX Automation Servers, L-ROC Room Controllers, and L-IOB I/O Controllers with physical inputs and outputs via plug and play.

Local Operation and Override

All L-IOB I/O Modules are equipped with an LCD display (128x64) with backlight and jog dial for manual local operation. Device and data point information is displayed in text form and via graphical symbols.

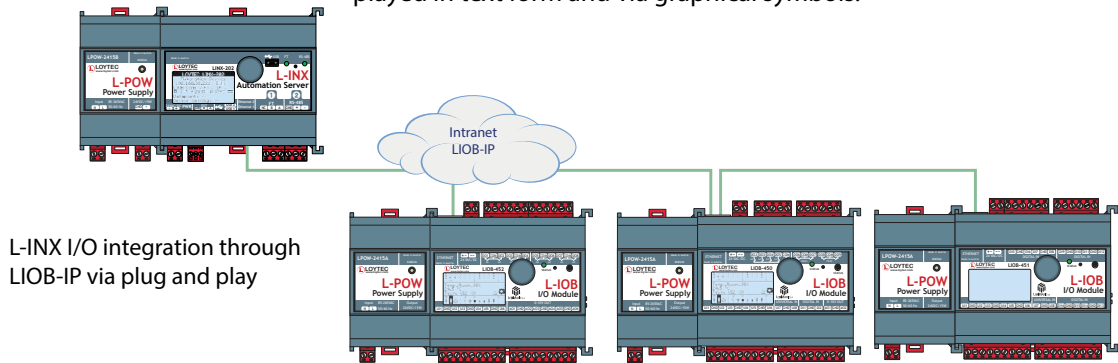

L-INX I/O integration through LIOB-IP via plug and play

Features

- I/O module with physical inputs and outputs
- Dual Ethernet/IP interface
- BACnet objects for integration in BACnet/IP, BACnet/SC channels
- BACnet Client Mappings to access to BACnet/IP, BACnet/SC objects
- Fulfills the BACnet Building Controller Profile (B-BC)
- Manual operation using the jog dial or VNC client
- 128x64 graphic display with backlight
- Local access to information about device status and data points in clear text and symbols
- Integrated web server for device configuration and monitoring data points
- Compliant with ANSI/ASHRAE 135-2012 and ISO 16484-5:2012 standard
- B-BC (BACnet Building Controller) functionality, BTL certified
- Supports BACnet Alarming, Scheduling, and Trending
- Connected to the L-INX Automation Server, L-ROC Room Controller, and L-IOB I/O Controller
- Automatic integration into device configurations with L-INX, L-ROC, and L-IOB I/O Controller
- Easy device replacement without any additional software
- Built-in OPC XML-DA and OPC UA server
- Math objects to execute mathematical operations on data points

LI0B-550/551/552/553/554 V2

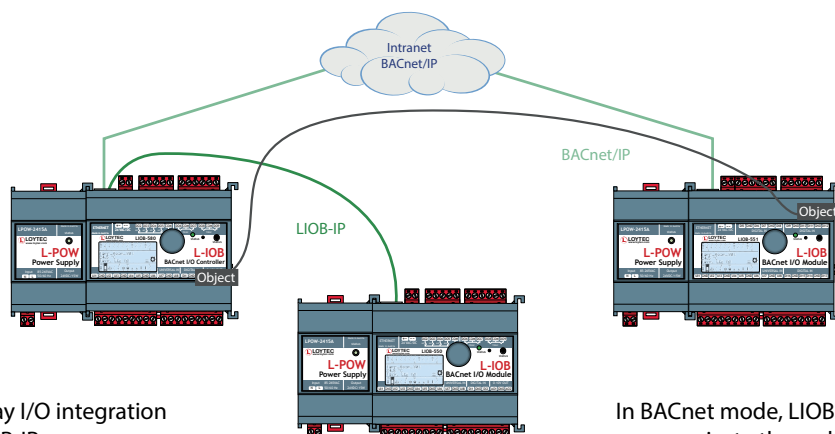

Plug and play I/O integration through LI0B-IP

In BACnet mode, LI0B-BIP devices communicate through BACnet/IP

General Specifications

Dimensions (mm)	107 x 100 x 75 (L x W x H), DIM018, DIM019, DIM020, DIM021, DIM022
Installation	DIN rail mounting following DIN 43880, top hat rail EN 50022
Operating conditions	0 °C to 50 °C, 10–90 % RH, noncondensing, degree of protection: IP40, IP20 (terminals)
Power supply	24 VDC / 24 VAC ±10 % via L-INX, L-ROC, L-POW or LI0B-A2/A4 via LI0B-Connect
Interface	2 x Ethernet (100Base-T): OPC XML-DA, OPC UA, LI0B-IP, BACnet/IP, BACnet/SC

Specifications LI0B-BIP I/O Module (LI0B-55x)

Type	LI0B-550	LI0B-551	LI0B-552	LI0B-553	LI0B-554
Power consumption	4.5 W (Relays on)	4.5 W	4.5 W (Relays on)	4.5 W (Relays on)	4.5 W (Relays on)
Universal Input (UI)	8	8	6	6	7
Digital Input (DI)	2	12	-	-	-
Analog Output (AO)	2	-	6	6	4
Digital Output (DO)	8 (4 x Relay 6 A, 4 x TRIAC 0.5 A)	-	8 (8 x Relay 6 A)	5 (4 x Relay 16 A, 1 x Relay 6 A)	7 (5 x Relay 6 A, 2 x Triac 0.5 A)
Digital Output specification	Please refer to the "General Input and Output Specification of LOYTEC devices" at the end of the L-IOB section for more details.				
Differential Pressure Sensor	-	-	-	-	±500 Pa

Resource limits

OPC data points	100	BACnet notification classes	32
BACnet objects	1 per I/O	Trend logs (BACnet or generic)	10 (130 000 entries, ≈ 2 MB)
BACnet client mappings	20	Total trended data points	10
BACnet calendar objects	10	Alarm logs	5
BACnet scheduler objects	5	Connections (Local / Global)	200 / 100
Math objects	20		

Order number Product description

LI0B-550	LI0B-BIP I/O Module: 8 UI, 2 DI, 2 AO, 8 DO (4 x Relay 6 A, 4 x Triac 0.5 A)
LI0B-551	LI0B-BIP I/O Module: 8 UI, 12 DI
LI0B-552	LI0B-BIP I/O Module: 6 UI, 6 AO, 8 DO (8 x Relay 6 A)
LI0B-553	LI0B-BIP I/O Module: 6 UI, 6 AO, 5 DO (4 x Relay 16 A, 1 x Relay 6 A)
LI0B-554	LI0B-BIP I/O Module: 7 UI, 4 AO, 7 DO (5 x Relay 6 A, 2 x Triac 0.5 A), 1 Pressure Sensor
LPOW-2415A	LI0B-Connect power supply unit, 24 VDC, 15 W
LPOW-2415B	Power supply unit with power connector 24 VDC, 15 W
L-TEMP2	External temperature sensor (NTC10K) for use with L-IOB Universal Inputs

LIOB-560

Datasheet #89092201



The LIOB-560 Modules communicate over Ethernet/IP in the BACnet/IP and BACnet/SC network. They adhere to the BACnet Building Controller Profile (B-BC) and either expose their I/O data points through BACnet server objects or actively fetch them from a BACnet server via BACnet client maps.

According to the B-BC profile, the LIOB-560 Modules support BACnet alarming, scheduling, and trending. They are BTL tested and certified.

Communication

The LIOB-560 I/O Modules are equipped with two Ethernet ports including a built-in Ethernet switch. This allows for building a daisy chained line topology of up to 20 devices, which reduces costs for network installation. Dual Ethernet port devices also allow the setup of a redundant Ethernet installation (ring topology), which increases reliability. The redundant Ethernet topology is enabled by the Rapid Spanning Tree Protocol (RSTP), which is supported by most managed switches.

The LIOB-560 Modules are equipped with a web interface to query the device status and display or change each data point of the module. In addition to the BACnet object interface, the I/O data points are exposed by the integrated OPC server providing TLS encrypted web services (OPC XML-DA) or UA Secure Conversation (OPC UA). The local display can be accessed via VNC.

LIOB-IP Mode

The LIOB-560 Modules can be switched to LIOB-IP mode using manual local operation. In LIOB-IP mode, the LIOB-560 Modules extend L-INX Automation Servers, L-ROC Room Controllers, and L-IOB I/O Controllers with physical inputs and outputs via plug and play.

Local Operation and Override

All L-IOB I/O Modules are equipped with an LCD display (128x64) with backlight and jog dial for manual local operation. Device and data point information is displayed in text form and via graphical symbols.

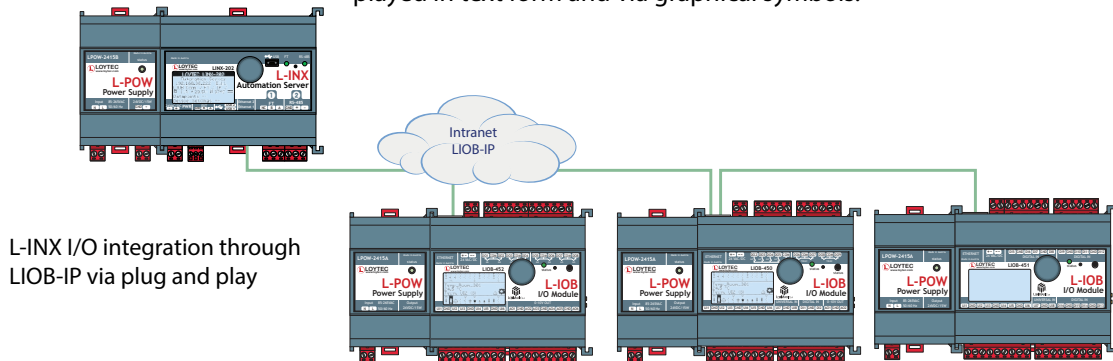

L-INX I/O integration through LIOB-IP via plug and play

Features

- I/O module with physical inputs and outputs
- Dual Ethernet/IP interface
- BACnet objects for integration in BACnet/IP, BACnet/SC channels
- BACnet Client Mappings to access to BACnet/IP, BACnet/SC objects
- Manual operation using the jog dial or VNC client
- 128x64 graphic display with backlight
- Local access to information about device status and data points in clear text and symbols
- Integrated web server for device configuration and monitoring data points
- Compliant with ANSI/ASHRAE 135-2012 and ISO 16484-5:2012 standard
- B-BC (BACnet Building Controller) functionality, BTL certified
- Supports BACnet Alarming, Scheduling, and Trending
- Connected to the L-INX Automation Server, L-ROC Room Controller, and L-IOB I/O Controller
- Automatic integration into device configurations with L-INX, L-ROC, and L-IOB I/O Controller
- Easy device replacement without any additional software
- Built-in OPC XML-DA and OPC UA server
- Math objects to execute mathematical operations on data points

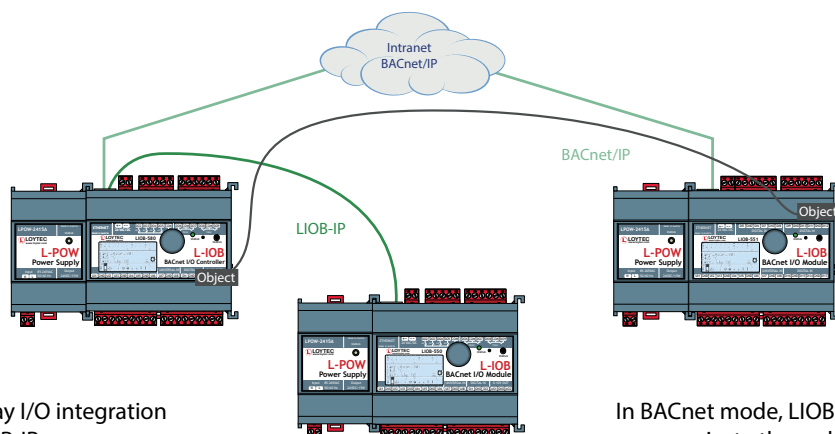

Plug and play I/O integration through LI0B-IP

In BACnet mode, LI0B-BIP devices communicate through BACnet/IP

General Specifications

Dimensions (mm)	107 x 100 x 75 (L x W x H), DIM087
Installation	DIN rail mounting following DIN 43880, top hat rail EN 50022
Operating conditions	0 °C to 50 °C, 10 – 90 % RH, noncondensing, degree of protection: IP40, IP20 (terminals)
Power supply	24 VDC / 24 VAC ±10 %
Interface	2 x Ethernet (100Base-T): OPC XML-DA, OPC UA, LI0B-IP, BACnet/IP, BACnet/SC

Specifications

Power consumption	4.5 W ¹
Universal I/O (IO)	20
I/O specification	Please refer to the “General Input and Output Specification of LOYTEC devices” at the end of the LI0B section for more details.

Resource limits

OPC data points	100	BACnet notification classes	32
BACnet objects	1 per I/O	Trend logs (BACnet or generic)	20 (260 000 entries, ≈ 4 MB)
BACnet client mappings	20	Total trended data points	20
BACnet calendar objects	10	Alarm logs	5
BACnet scheduler objects	5	Connections (Local / Global)	200 / 100
Math objects	20		

Order number Product description

LI0B-560	LI0B-BIP I/O Module: 20 Universal I/O (IO)
LPOW-2415A	LI0B-Connect power supply unit, 24 VDC, 15 W
LPOW-2415B	Power supply unit with power connector 24 VDC, 15 W
LPOW-2460B	Power supply unit with power connector 24 VDC, 60 W
L-TEMP2	External temperature sensor (NTC10K) for use with LI0B Universal Inputs

¹ Add external load: Sum of max. current drawn from all outputs x 24V

LIOB-BIP I/O Module

LIOB-562

Datasheet #89093401

✓ BACnet
CEA-709
KNX

Modbus
M-Bus
✓ OPC



The LIOB-562 Modules communicate over Ethernet/IP in the BACnet/IP and BACnet/SC network. They adhere to the BACnet Building Controller Profile (B-BC) and either expose their I/O data points through BACnet server objects or actively fetch them from a BACnet server via BACnet client maps.

According to the B-BC profile, the LIOB-562 Modules support BACnet alarming, scheduling, and trending. They are BTL tested and certified.

Communication

The LIOB-562 I/O Modules are equipped with two Ethernet ports including a built-in Ethernet switch. This allows for building a daisy chained line topology of up to 20 devices, which reduces costs for network installation. Dual Ethernet port devices also allow the setup of a redundant Ethernet installation (ring topology), which increases reliability. The redundant Ethernet topology is enabled by the Rapid Spanning Tree Protocol (RSTP), which is supported by most managed switches.

The LIOB-562 Modules are equipped with a web interface to query the device status and display or change each data point of the module. In addition to the BACnet object interface, the I/O data points are exposed by the integrated OPC server providing TLS encrypted web services (OPC XML-DA) or UA Secure Conversation (OPC UA). The local display can be accessed via VNC.

LIOB-IP Mode

The LIOB-562 Modules can be switched to LIOB-IP mode using manual local operation. In LIOB-IP mode, the LIOB-562 Modules extend L-INX Automation Servers, L-ROC Room Controllers, and L-IOB I/O Controllers with physical inputs and outputs via plug and play.

Local Operation and Override

All L-IOB I/O Modules are equipped with an LCD display (128x64) with backlight and jog dial for manual local operation. Device and data point information is displayed in text form and via graphical symbols.

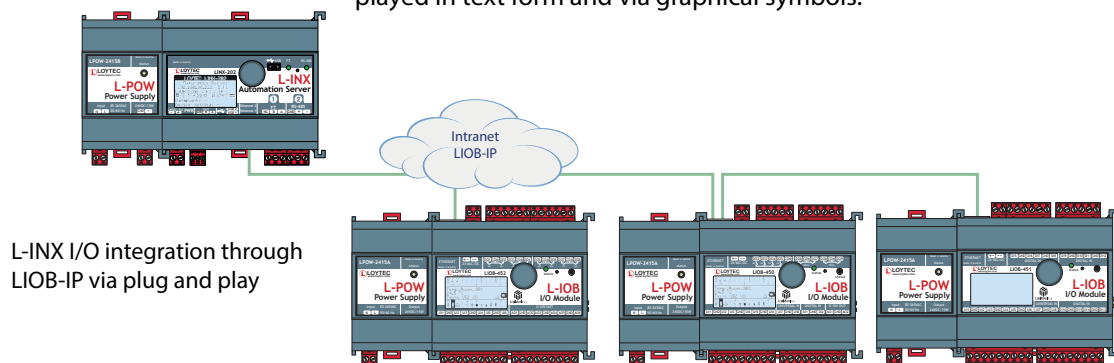

L-INX I/O integration through LIOB-IP via plug and play

Features

- I/O module with physical inputs and outputs
- Dual Ethernet/IP interface
- BACnet objects for integration in BACnet/IP, BACnet/SC channels
- BACnet Client Mappings to access to BACnet/IP, BACnet/SC objects
- Manual operation using the jog dial or VNC client
- 128x64 graphic display with backlight
- Local access to information about device status and data points in clear text and symbols
- Integrated web server for device configuration and monitoring data points
- Compliant with ANSI/ASHRAE 135-2012 and ISO 16484-5:2012 standard
- B-BC (BACnet Building Controller) functionality, BTL certified
- Supports BACnet Alarming, Scheduling, and Trending
- Connected to the L-INX Automation Server, L-ROC Room Controller, and L-IOB I/O Controller
- Automatic integration into device configurations with L-INX, L-ROC, and L-IOB I/O Controller
- Easy device replacement without any additional software
- Built-in OPC XML-DA and OPC UA server
- Math objects to execute mathematical operations on data points

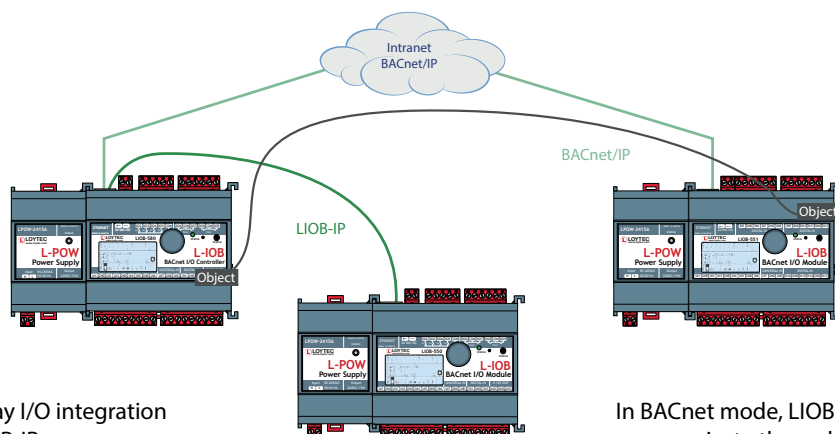

Plug and play I/O integration through LIQB-IP

In BACnet mode, LIQB-BIP devices communicate through BACnet/IP

General Specifications	
Dimensions (mm)	159 x 100 x 75 (L x W x H), DIM088
Installation	DIN rail mounting following DIN 43880, top hat rail EN 50022
Operating conditions	0 °C to 50 °C, 10 – 90 % RH, noncondensing, degree of protection: IP40, IP20 (terminals)
Power supply	24 VDC / 24 V AC ±10 %
Interfaces	2 x Ethernet (100Base-T): OPC XML-DA, OPC UA, LIQB-IP, BACnet/IP, BACnet/SC

Specifications	
Power consumption	2.5 W + 0.5 W for each Oxx (max 6 W) ¹
Universal I/O (IO)	40 ²
I/O specification	Please refer to the “General Input and Output Specification of LOYTEC devices” at the end of the L-IOB section for more details.

Resource limits			
OPC data points	200	BACnet notification classes	32
BACnet objects	1 per I/O	Trend logs (BACnet or generic)	40 (520 000 entries, ≈ 8 MB)
BACnet client mappings	20	Total trended data points	40
BACnet calendar objects	10	Alarm logs	5
BACnet scheduler objects	5	Connections (Local / Global)	200 / 100
Math objects	20		

Order number	Product description
LIQB-562	LIQB-BIP I/O Module: 40 Universal I/O, (12 optionally with 4-20 mA current output)
LPOW-2415A	LIQB-Connect power supply unit, 24 VDC, 15 W
LPOW-2415B	Power supply unit with power connector 24 VDC, 15 W
LPOW-2460B	Power supply unit with power connector 24 VDC, 60 W
L-TEMP2	External temperature sensor (NTC10K) for use with L-IOB Universal Inputs

¹ Add external load: Sum of max. current drawn from all outputs x 24V

² O29-O40 are internally connected to IO29-IO40 and provide 4-20 mA outputs in parallel to the 0-10 V outputs on IO29-IO40.

General Input and Output Specification of LOYTEC devices

Datasheet #89049123

UI – Universal Input

UIs are universal inputs for four different input types. They have an input voltage range of SELV 0 to 10 V (4-20 mA), and can withstand up to 30 V. The UIs correspond to class 1 with a relative accuracy of $\pm 1\%$ (of measured value) between 1 V and 10 V, and an absolute accuracy of ± 10 mV between 0 V and 1 V. The ADC resolution is 16 bits. Galvanically isolated sensors resp. switches must be connected. Universal inputs can be configured as:

- **Binary Input (Digital Input)**

Input impedance $> 20\text{ k}\Omega$, sampling period 10 ms.

- In voltage mode, the threshold values are $< 0.8\text{ V}$ for low level and $> 2\text{ V}$ for high level.
- In resistance mode, the threshold values are $< 1.9\text{ k}\Omega$ for low level and $> 6.7\text{ k}\Omega$ for high level.

Between the threshold values, the resulting level of the UI is not defined.

- **Voltage Metering 0-10 V**

Input Impedance $> 20\text{ k}\Omega$, sampling period $< 1\text{ s}$.

- **Current loop 4-20 mA**

Input Impedance $> 20\text{ k}\Omega$, sampling period $< 1\text{ s}$. An internal shunt of $249\ \Omega$ is available for some universal inputs. Otherwise, an external resistor of $249\ \Omega$ must be used as a shunt.

- **Resistance Measurement**

Input Impedance $10\text{ k}\Omega$, sampling period $< 1\text{ s}$. Resistors in the range of $1\text{ k}\Omega$ to $100\text{ k}\Omega$ can be measured. For popular temperature sensors (e.g. Pt1000, NTC10K, NTC1K8, Ni1000) fixed internal translation tables are provided. For all other temperature sensors, translation tables can be defined in the configuration tool and used on the device.

The average sampling period p of analog inputs depends on the number of active (non-disabled) universal inputs n that are configured in analog mode. The formula for p is:

$$p = n \cdot 125\text{ ms}$$

This means if e.g. only two UIs are configured as analog inputs, a new sample is taken every 250 ms (on average) for each of the two inputs. The UIs configured as digital inputs are unaffected (sampling period always 10 ms) by this formula.

DI – Digital Input, Counter Input (S0-Pulse)

DIs are fast binary inputs, which can also be used as counter inputs (S0). They follow the S0 specification for electric meters and have a sampling rate of 10 ms. They change state at a load of $195\ \Omega$ between the DI terminal and GND. Galvanically isolated sensors resp. switches must be connected. The input can withstand up to 30 V SELV.

AO – Analog Output

AOs are analog outputs with a signal range of SELV 0 to 10 V (up to 12 V), a resolution of 10 bits, and a maximum output current of 10 mA, short circuit proof (2 outputs at a time). The accuracy over the whole range is $\pm 100\text{ mV}$.

DO – Digital Output

The following digital outputs are available:

- Relay 2 A 24 V Output: Switching capacity 2 A, 24 V AC / 24 VDC (resistive). This output is designed to connect external interface relays.
- Relay 2 A Output: Switching capacity 2 A, 250 V AC resp. 30 VDC. Max in-rush current 2 A, max. 300 W (resistive) @ 250 VAC.
- Relay 6 A Output: Switching capacity 6 A, 250 V AC resp. 30 VDC. Max in-rush current 6 A, max. 600 W (resistive) @ 250 VAC.
- Relay 8 A Output: Switching capacity 8 A, 250 V AC resp. 30 VDC. Max in-rush current 8 A, max. 1600 W (resistive) @ 250 VAC.
- Relay 10 A Output: Switching capacity 10 A, 250 V AC. Max in-rush current 10 A, max. 1600 W (resistive) @ 250 VAC.
- Relay 10 A Type2: Same as 10 A relay, but switching DC voltage is not UL rated.

General Input and Output Specification of LOYTEC devices

- Relay 16 A Output: Switching capacity 16 A, 250 VAC resp. 30 VDC. Max in-rush current 80 A, max. 2000 W (resistive) @ 250 VAC. Note, that switching DC voltage is not UL rated.
- TRIAC Output: Switching capacity 0.5 A, 24 to 240 VAC, 50/60 Hz. External relays must not be connected.

When switching higher loads than specified an interface relay must be used. When connecting an external interface relay to a L-IOB relay, a quenching circuit like a varistor or RC element must be used.

PRESS – Pressure Sensor

These inputs represent differential pressure sensors which measure pressures from –500 to +500 Pascal at 14-Bit resolution. They are equipped with two 3/16" (4.8 mm) hose connectors.

IO – Universal Analog/Digital Input/Output

IOs are universal input/output terminals which can be configured as an input to measure resistance, voltage, or current (with or without internal shunt), or as an output to drive a 0-10 V voltage output.

The IOs have an input voltage range of 0 to 10 V, and can withstand up to 30 V. The IOs correspond to class 1 with a relative accuracy of $\pm 0.5\%$ (of measured value) between 1 V and 10 V, and an absolute accuracy of ± 5 mV between 0 V and 1 V. The A DC resolution is 12 bits. Galvanically isolated sensors resp. switches must be connected. The sampling period of IO inputs is 50 ms. This limits Pulse Count inputs to a maximum frequency of 10 Hz.

In output mode, the IOs have a signal range from 0 to 10 V, a resolution of 12 bits, and a maximum output current of 2 mA (short circuit proof). The accuracy over the whole range is ± 100 mV. If used as digital output (0 V or 10 V) the maximum output current is 20 mA.

O – 4-20 mA Current Output

O-terminals are analog current outputs with a signal range of 4-20 mA and a resolution of 12 bits.

Gateways



Gateways

L-GATE, L-INX, L-DALI



L-GATE Gateways are conceived as universal gateways to map and connect data points from different communication technologies. This mapping and connecting is summarized with the term “Connections”. The configuration tool can create such connections either manually or automatically by using Smart Auto-Connect™. Local and Global Connections are distinguished. Local Connections allow connections between data points from different communication technologies located on the very same device. A Global Connection provides similar functions as a Local Connection, but can span across an IP network between two or more LOYTEC devices. A Global Connection establishes a data cloud defining a system wide name. Data points that are members of this data cloud get their input values automatically updated or can send their output values for the other cloud members to update their data point values.

The L-INX Automation Servers support the same gateway functionalities as described for the L-GATE products. Specifically the LINX-102/103 and LINX-202/203 Automation Servers can be used as very cost effective gateway solutions. The LINX-102/103 supports connectivity to LonMark Systems, Modbus, M-Bus, MP-Bus and OPC XML-DA. The LINX-202/203 supports connectivity to BACnet, Modbus, M-Bus, MP-Bus and OPC XML-DA. In addition, the L-INX Automation Servers can integrate physical I/Os through L-IOB I/O Modules. These I/O data points can also be utilized in the gateway connections.

The L-INX Automation Servers and L-GATE Gateways are configured with the very same configuration tool. Therefore the work flows are identical. The L-INX and L-GATE product offering provides a wide spectrum of gateway solutions for our customers to benefit from the variety and flexibility when picking the most suitable model.

Also the L-DALI Lighting Controllers offer gateway functionality to integrate DALI lighting control systems into LonMark Systems or BACnet networks.

Features	LGATE-952	LGATE-902	LINX-102	LINX-103	LINX-202	LINX-203
LON IP-852 – TP/FT-10	X	X	X	X		
BACnet/IP – MS/TP	X	X			X	X
KNXnet/IP – KNX TP1	X	X	X	X	X	X
EnOcean	X	X	X	X	X	X
SMI	X	X	X	X	X	X
Modbus TCP – Modbus RTU	X	X	X	X	X	X
M-Bus	X	X	X	X	X	X
MP-Bus	X	X	X	X	X	X
OPC XML-DA, OPC UA Server	X	X	X	X	X	X
Dual Ethernet (switched or separated)	X	X	X	X	X	X
WLAN	X	X	X	X	X	X
LTE	X	X	X	X	X	X
IP-852 Router				X		
BACnet Router						X
LON Remote Network Interface	X	X	X			
Support of L-IOB I/O Modules			X	X	X	X
L-WEB Visualization	X	X	X	X	X	X

- ✓ BACnet
- ✓ CEA-709
- ✓ KNX
- ✓ Modbus
- ✓ M-Bus
- ✓ OPC

Datasheet #89023323

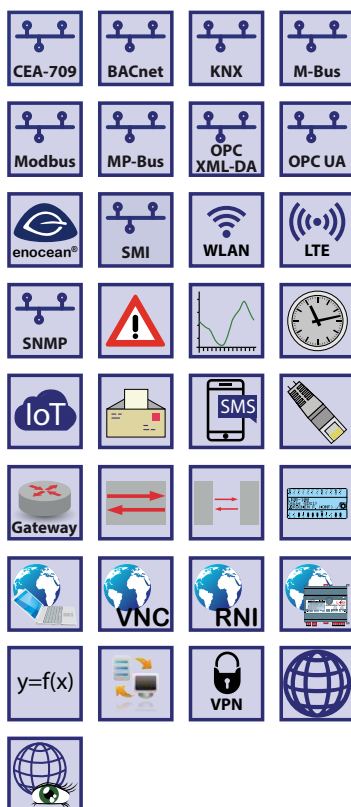

The L-GATE Gateway LGATE-952 are powerful universal gateways that can host user specific graphical pages to be used with LWEB-802/803. They can simultaneously integrate and map data points from multiple open protocols. Local operation and override is provided by the built-in jog dial and the backlit display (128x64 pixels). Device and data point information is provided by the web interface and shown on the display via symbols and in text format.

The powerful universal gateways provide connectivity functions to concurrently integrate CEA-709 (LonMark Systems), BACnet, KNX, Modbus, and M-Bus subsystems. LonMark Systems can be integrated via IP-852 (Ethernet/IP) or TP/FT-10. BACnet integration is supported through BACnet/IP (Ethernet/IP) or BACnet MS/TP (RS-485). LGATE-952 feature an integrated Remote Network Interface (RNI) to access the TP/FT-10 channel on the device via Ethernet/IP. LGATE devices implement the BACnet Building Controller (B-BC) profile, can be configured to be a BBMD and are BTL certified. In addition, the universal gateways provide connectivity to KNXnet/IP and Modbus TCP via Ethernet/IP and to Modbus RTU via RS-485. M-Bus and KNX TP1 device integration needs optional interface modules.

The gateway functionality allows data communication between all communication technologies available on the device. Different technology data points are mapped through Local Connections on the device. The mapping of different technology data points on distributed devices is supported by Global Connections. The universal gateways LGATE-952 also support Smart Auto-Connect™ – the automatic generation of connections to substantially reduce engineering efforts and cost. Optionally, mathematical objects can be applied within a connection to calculate the data point output values depending on the formula used. All technology data points are automatically created as OPC XML-DA and OPC UA data points.

Each LGATE-952 is equipped with two Ethernet ports. It can either be configured to use the internal switch to interconnect the two ports or every port is configured to work in a separate IP network.

When the Ethernet ports are configured for two separate IP networks, one port can be connected for instance to a WAN (Wide Area Network) with enabled network security (HTTPS) while the second port can be configured to be connected to an insecure network (LAN) where the standard building automation protocols like BACnet/IP, LON/IP, or Modbus TCP are present. These devices also feature firewall functionality of course to isolate particular protocols or services between the ports. The built-in VPN function provides for simple VPN setup and secure access to remote sites. The LTE-800 interface enables wireless access to remote sites through a mobile carrier.

Using the internal switch, a daisy chained line topology of up to 20 devices can be built, which reduces costs for network installation. The IP switch also allows the setup of a redundant Ethernet installation (ring topology), which increases reliability. The redundant Ethernet topology is enabled by the Rapid Spanning Tree Protocol (RSTP), which is supported by most managed switches.

The L-GATE devices provide fully featured AST™ functionality (Alarming, Scheduling, and Trending) and can be integrated perfectly into the L-WEB System.

IoT Integration

The IoT function (Node.js) allows connecting the system to almost any cloud service, either for uploading historical data to analytics services, telemetry using MQTT, delivering alarm messages to alarm processing services or operating parts of the control system over a cloud service (e.g., scheduling based on Web calendars or booking systems). Processing Internet information such as weather data in forecast-based control is also possible. Finally, the JavaScript kernel also allows implementing serial protocols to non-standard equipment in primary plant control.

L-GATE Gateway

LGATE-952

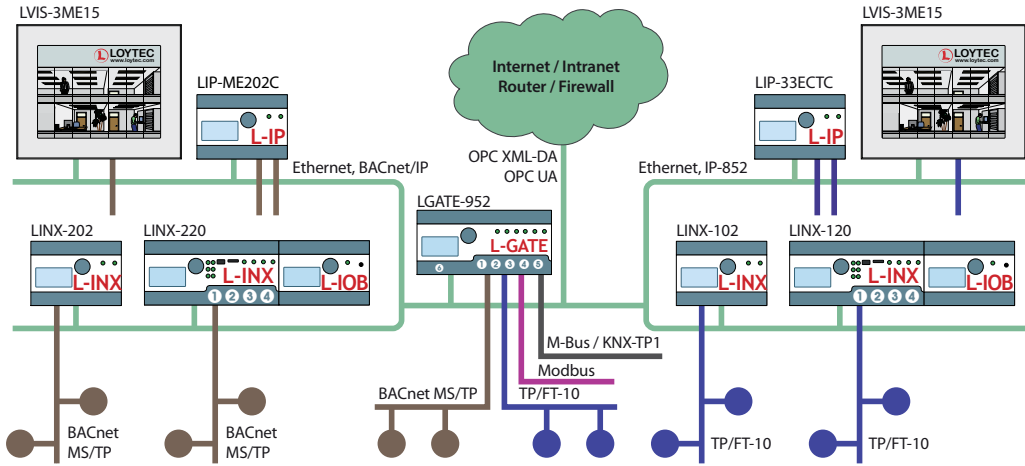

Features

- Universal gateway
- Compliant with ANSI/ASHRAE 135-2012 and ISO 16484-5:2012 standard
- B-BC (BACnet Building Controller) functionality
- Supports BBMD (BACnet Broadcast Management Device)
- Supports BACnet/IP, BACnet/SC or BACnet MS/TP
- BACnet Client Function (Write Property, Read Property, COV Subscription)
- BACnet Client Configuration with configuration tool (scan and EDE import)
- Compliant with CEA-709, CEA-852, and ISO/IEC 14908 Standard (LonMark System)
- Supports TP/FT-10 or IP-852 (Ethernet/IP)
- Support of dynamically created or static NVs
- Support of CEA-709 user-defined NVs (UNVNTs) and Configuration Properties (SCPTs, UCPTs)
- Remote Network Interface (RNI) with 2 MNI devices
- Support of KNX/IP directly, KNX TP1 via LKNX-300 Interface
- M-Bus Master according to EN 13757-3, connection via optional M-Bus Converter (L-MBUS20 or L-MBUS80)
- Modbus TCP and Modbus RTU (Master or Slave)
- Automatic creation of Local Connections (Smart Auto-Connect™)
- Math objects to execute mathematical operations on data points
- Automatic mapping of network variables to BACnet objects in accordance with CEN/TS 15231:2005
- Alarming, Scheduling, and Trending (AST™)
- Node.js support for easy IoT integration (e.g. Google calendar, Alexa & friends, multimedia equipment,...)
- Event-driven e-mail notification
- Stores customized graphical pages
- Visualization of customized graphical pages through LWEB-900 and LWEB-802/803
- Built-in OPC XML-DA and OPC UA server
- Dual Ethernet/IP interface
- Access to network statistics
- Integrated web server for device configuration and monitoring data points
- Manual operation using the jog dial or VNC client
- Local and remote access to information about device status and data points
- 128x64 graphic display with backlight
- Configurable via Ethernet/IP or TP/FT-10
- Connection to EnOcean wireless devices via LENO-80x Interface
- Supports SMI (Standard Motor Interface) through LSMI-80x
- Supports WLAN through LWLAN-800 Interface
- Supports LTE through LTE-800 Interface
- Supports MP-Bus through LMPBUS-804 Interface
- Supports RS-232 through LRS232-802 Interface
- Stores user-defined project documentation

Specifications

Type	LGATE-952
Dimensions (mm)	159 x 100 x 75 (L x W x H), DIM053
Installation	DIN rail mounting following DIN 43880, top hat rail EN 50022
Purpose of control	Operating control
Construction of control	Independently mounted control
Feature of automatic action	Type 1
Operating conditions	0 °C to 50 °C, 10 – 90 % RH, noncondensing, degree of protection: IP40, IP20 (terminals), pollution degree 2
Power supply	24 VDC/ V AC SELV ±10 %, typ. 2.5 W
Rated Impulse Voltage	330 V

Specifications

Type	LGATE-952
Interfaces	<p>2 x Ethernet (100Base-T): OPC XML-DA, OPC UA, LonMark IP-852*, BACnet/IP**, KNXnet/IP, Modbus TCP (Master or Slave), HTTP, FTP, SSH, HTTPS, Firewall, VNC, SNMP</p> <p>1 x TP/FT-10* (LonMark System)</p> <p>2 x USB-A: WLAN (needs LWLAN-800), EnOcean (needs LENO-80x), SMI (needs LSMI-804), MP-Bus (needs LMPBUS-804), LTE (needs LTE-800),</p> <p>2 x RS-485 (ANSI TIA/EIA-485): BACnet MS/TP** or Modbus RTU/ASCII (Master or Slave)</p> <p>3 x EXT: M-Bus, Master EN 13757-3 (needs L-MBUS20/80) or KNX TP1 (needs LKNX-300) or SMI (needs LSMI-800)</p> <p>* Either LonMark IP-852 or TP/FT-10 (no router) **Either BACnet/IP or 1x MS/TP on port 2 (no router)</p>

Tools	L-INX Configurator
Remote Network Interface	1 RNI with 2 MNI devices

Resource limits

Total number of data points	30 000	LonMark Schedulers	100
OPC data points	5 000	LonMark Alarm Servers	1
BACnet objects	2 000 (analog, binary, multi-state)	E-mail templates	100
BACnet client mappings	1 000	Math objects	100
BACnet calendar objects	25	Alarm logs	10
BACnet scheduler objects	100 (64 data points per object)	M-Bus data points	1 000
BACnet notification classes	32	Modbus data points	2 000
Trend logs (BACnet or generic)	512 (13 000 000 entries, ≈ 200 MB)	KNX TP1 data points	1 000
Total trended data points	2 000	KNXnet/IP data points	1 000
CEA-709 network variables (NVs)	2 000	Connections (Local / Global)	2 000 / 250
CEA-709 Alias NVs	2 000	Number of L-WEB clients	32 (simultaneously)
CEA-709 External NVs (polling)	2 000	Number of EnOcean devices	100
CEA-709 address table entries	1 000 (non-ECS mode: 15)	EnOcean data points	1 000
LonMark Calendars	1 (25 calendar patterns)	SMI devices (per channel)	16

Order number	Product description
LGATE-952	Universal Gateway
LPOW-2415A	LIOB-Connect power supply unit, 24 VDC, 15 W
LPOW-2415B	Power supply unit with power connector 24 VDC, 15 W
L-MBUS20	M-Bus Level Converter, Interface for up to 20 M-Bus devices
L-MBUS80	M-Bus Level Converter, Interface for up to 80 M-Bus devices
LKNX-300	KNX interface to connect KNX TP1 devices
LENO-800	EnOcean Interface 868 MHz Europe
LENO-801	EnOcean Interface 902 MHz USA/Canada
LENO-802	EnOcean Interface 928 MHz Japan
LWLAN-800	Wireless LAN Interface IEEE 802.11bgn
LMPBUS-804	MP-Bus interface for 16 devices per channel, up to 4 channels
LSMI-800	Standard Motor Interface for 16 motors via EXT port
LSMI-804	Standard Motor Interface for 64 motors, 4 SMI channels via USB
LTE-800	LTE Interface
LRS232-802	USB to 2 x RS-232 Interface

L-GATE Gateway

LGATE-902

Datasheet #89035823

- ✓ BACnet
- ✓ CEA-709
- ✓ KNX
- ✓ Modbus
- ✓ M-Bus
- ✓ OPC

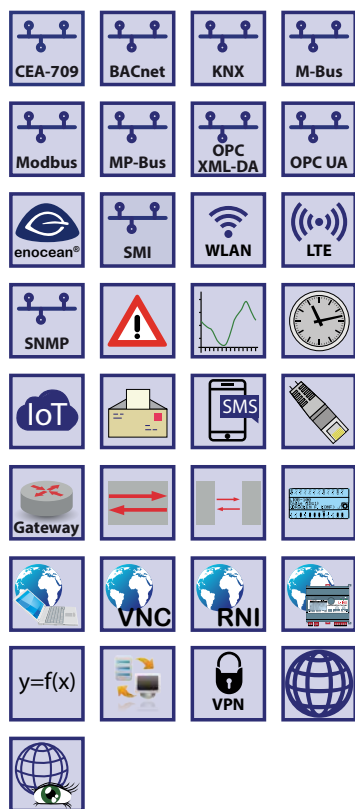
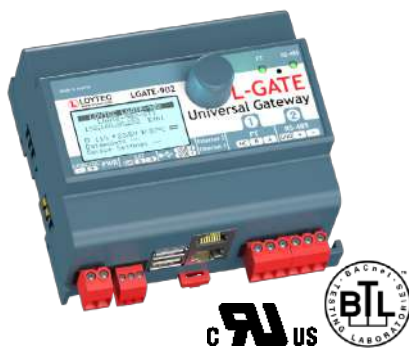

The LGATE-902 Gateway is a powerful gateway that can host user specific graphical pages. The gateways provide connectivity functions to concurrently integrate CEA-709 (LonMark Systems), BACnet, KNX, Modbus, and M-Bus. Local operation and override is provided by the built-in jog dial and the backlit display (128x64 pixels). Device and data point information is provided by the web interface and shown on the display via symbols and in text format.

LonMark Systems can be integrated via IP-852 (Ethernet/IP) or TP/FT-10. LGATE-902 features an integrated Remote Network Interface (RNI) to access the TP/FT-10 channel on the device via Ethernet/IP. BACnet integration is supported through BACnet/IP (Ethernet/IP), BACnet/SC or BACnet MS/TP (RS-485). LGATE-902 is BACnet Building Controller (B-BC) BTL certified and can be configured to be a BBMD.

In addition, the gateway provides connectivity to KNXnet/IP and Modbus (RTU, TCP, Master or Slave). M-Bus and KNX TP1 device integration needs optional interface modules.

Through the built-in web server, all data points can be monitored and changed. The gateway functionality allows data communication between all communication technologies available on the device. Different technology data points are mapped through Local Connections on the device. The mapping of different technology data points on distributed devices is supported by Global Connections. The gateway also support Smart Auto-Connect™ – the automatic generation of connections to substantially reduce engineering efforts and cost. Math objects allow to execute mathematical operations on data points. All technology data points are automatically created as OPC XML-DA and OPC UA data points.

The LGATE-902 Gateway is equipped with two Ethernet ports. It can either be configured to use the internal switch to interconnect the two ports or every port is configured to work in a separate IP network.

When the Ethernet ports are configured for two separate IP networks, one port can be connected for instance to a WAN (Wide Area Network) with enabled network security (HTTPS) while the second port can be configured to be connected to an insecure network (LAN) where the standard building automation protocols like BACnet/IP, LON/IP, or Modbus TCP are present. These devices also feature firewall functionality of course to isolate particular protocols or services between the ports. The built-in VPN function provides for simple VPN setup and secure access to remote sites. The LTE-800 interface enables wireless access to remote sites through a mobile carrier.

Using the internal switch, a daisy chained line topology of up to 20 devices can be built, which reduces costs for network installation. The IP switch also allows the setup of a redundant Ethernet installation (ring topology), which increases reliability. The redundant Ethernet topology is enabled by the Rapid Spanning Tree Protocol (RSTP), which is supported by most managed switches.

The L-GATE devices provide fully featured AST™ functionality (Alarming, Scheduling, and Trending) and can be integrated perfectly into the L-WEB System.

IoT Integration

The IoT function (Node.js) allows connecting the system to almost any cloud service, either for uploading historical data to analytics services, telemetry using MQTT, delivering alarm messages to alarm processing services or operating parts of the control system over a cloud service (e.g., scheduling based on Web calendars or booking systems). Processing Internet information such as weather data in forecast-based control is also possible. Finally, the JavaScript kernel also allows implementing serial protocols to non-standard equipment in primary plant control.

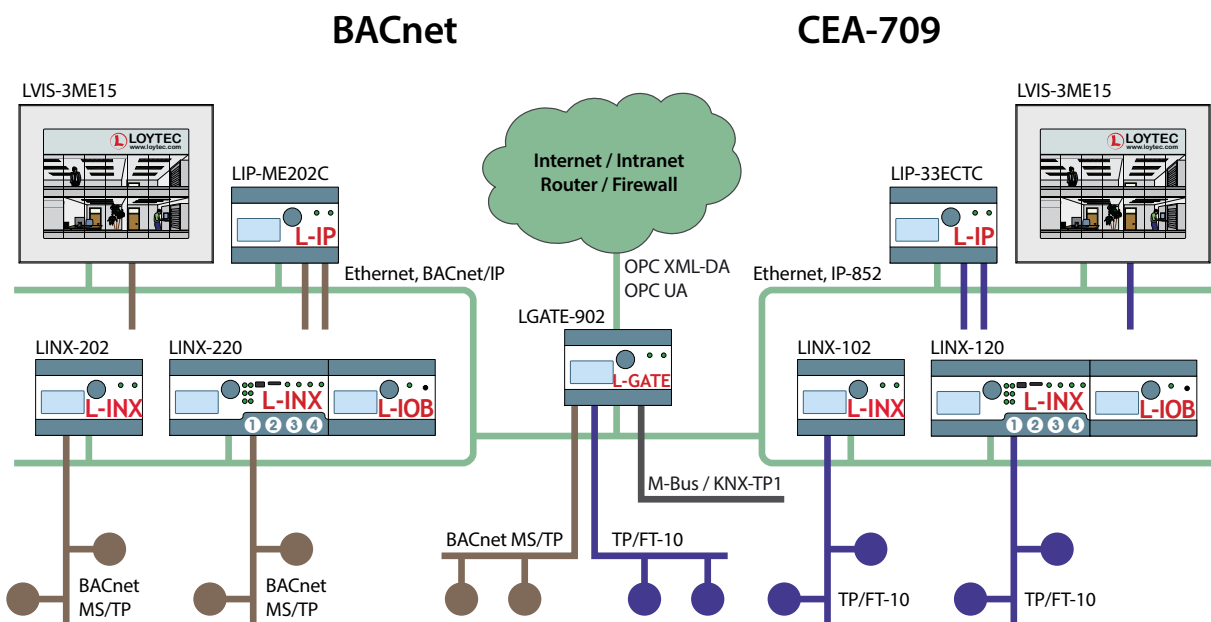

Features

- Universal Gateway for BACnet, LonMark, KNX, Modbus, M-Bus, and EnOcean
- Compliant with ANSI/ASHRAE 135-2012 and ISO 16484-5:2012 standard
- B-BC (BACnet Building Controller) functionality, BTL certified
- Supports BBMD (BACnet Broadcast Management Device)
- Supports BACnet/IP, BACnet/SC or BACnet MS/TP
- BACnet Client Function (Write Property, Read Property, COV Subscription)
- BACnet Client Configuration with configuration tool (scan and EDE import)
- Compliant with CEA-709, CEA-852, and ISO/IEC 14908 Standard (LonMark System)
- Supports TP/FT-10 or IP-852 (Ethernet/IP)
- Support of dynamically created or static NVs
- Support of user-defined NVs (UNVTs) and Configuration Properties (SCPTs, UCPTs)
- Remote Network Interface (RNI) with 2 MNI devices
- Direct connection to KNX/IP, KNX TP1 connection via LKNX-300 Interface
- M-Bus Master according to EN 13757-3, connection via M-Bus Level Converter (LMBUS-20 or LMBUS-80)
- Modbus TCP and Modbus RTU (Master or Slave)
- Automatic creation of Local Connections (Smart Auto-Connect™)
- Math objects to execute mathematical operations on data points
- Automatic mapping of network variables to BACnet objects in accordance with CEN/TS 15231:2005
- Alarming, Scheduling, and Trending (AST™)
- Node.js support for easy IoT integration (e.g. Google calendar, Alexa & friends, multimedia equipment,...)
- Event-driven e-mail notification
- Stores customized graphical pages
- Visualization of customized graphical pages through LWEB-900 and LWEB-802/803
- Built-in OPC XML-DA and OPC UA server
- Dual Ethernet/IP interface
- Access to network statistics
- Integrated web server for device configuration and monitoring data points
- Manual operation using the jog dial or VNC client
- Local and remote access to information about device status and data points
- 128x64 graphic display with backlight
- Configurable via Ethernet/IP or TP/FT-10
- Connection to EnOcean wireless devices via LENO-80x Interface
- Supports SMI (Standard Motor Interface) through LSMI-80x
- Supports WLAN through LWLAN-800 Interface
- Supports LTE through LTE-800 Interface
- Supports MP-Bus through LMPBUS-804 Interface
- Supports RS-232 through LRS232-802 Interface
- Stores user-defined project documentation

Specifications	
Dimensions (mm)	107 x 100 x 75 (L x W x H), DIM045
Installation	DIN rail mounting following DIN 43880, top hat rail EN 50022
Power supply	24 VDC / 24 VAC \pm 10 %, typ. 2.5 W
Operating conditions	0 °C to 50 °C, 10 – 90 % RH, noncondensing, degree of protection: IP40, IP20 (terminals)
Interfaces	2 x Ethernet (100Base-T): OPC XML-DA, OPC UA, LonMark IP-852**, BACnet/IP*, BACnet/SC*, KNXnet/IP, Modbus TCP (Master or Slave), HTTP, FTP, SSH, HTTPS, Firewall, VNC, SNMP 2 x USB-A: WLAN (needs LWLAN-800), EnOcean (needs LENO-80x) SMI (needs LSMI-804) LTE (needs LTE-800) MP-Bus (needs LMPBUS-804) * Either BACnet/IP or BACnet MS/TP ** Either LonMark IP-852 or TP/FT-10
	1 x TP/FT-10** (LonMark system) 1 x RS-485 (ANSI TIA/EIA-485): BACnet MS/TP* or Modbus RTU/ASCII (Master or Slave) 1 x EXT: M-Bus, Master EN 13757-3 (needs L-MBUS20/80) or KNX TP1 (needs LKNX-300) or SMI (needs LSMI-800)

Tools	L-INX Configurator
Remote Network Interface	1 RNI with 2 MNI devices

Resource limits			
Total number of data points	10 000	LonMark Schedulers	100
OPC data points	2 000	LonMark Alarm Servers	1
BACnet objects	2 000 (analog, binary, multi-state)	E-mail templates	100
BACnet client mappings	750	Math objects	100
BACnet calendar objects	25	Alarm logs	10
BACnet scheduler objects	100 (64 data points per object)	M-Bus data points	250
BACnet notification classes	32	Modbus data points	250
Trendlogs (BACnet or generic)	256 (13 000 000 entries, \approx 200 MB)	KNX TP1 data points	250
Total trended data points	256	KNXnet/IP data points	250
CEA-709 network variables (NVs)	1 000	Connections (Local / Global)	1 000 / 250
CEA-709 Alias NVs	1 000	Number of L-WEB clients	32 (simultaneously)
CEA-709 External NVs (polling)	1 000	Number of EnOcean devices	25
CEA-709 address table entries	512 (non-ECS mode: 15)	EnOcean data points	250
LonMark Calendars	1 (25 calendar patterns)	SMI devices (per channel)	16

Order Number	Product Description
LGATE-902	Universal Gateway
LPOW-2415A	LIOB-Connect power supply unit, 24 VDC, 15 W
LPOW-2415B	Power supply unit with power connector 24 VDC, 15 W
L-MBUS20	M-Bus Level Converter, Interface for up to 20 M-Bus devices
L-MBUS80	M-Bus Level Converter, Interface for up to 80 M-Bus devices
LKNX-300	KNX interface to connect KNX TP1 devices
LENO-800	EnOcean Interface 868 MHz Europe
LENO-801	EnOcean Interface 902 MHz USA/Canada
LENO-802	EnOcean Interface 928 MHz Japan
LWLAN-800	Wireless LAN Interface IEEE 802.11bgn
LMPBUS-804	MP-Bus interface for 16 devices per channel, up to 4 channels
LSMI-800	Standard Motor Interface for 16 motors via EXT port
LSMI-804	Standard Motor Interface for 64 motors, 4 SMI channels via USB
LTE-800	LTE Interface
LRS232-802	USB to 2 x RS-232 Interface

- ✓ BACnet
- ✓ CEA-709
- ✓ KNX
- ✓ Modbus
- ✓ M-Bus
- ✓ OPC

LINX-102, LINX-103

Datasheet #89035222

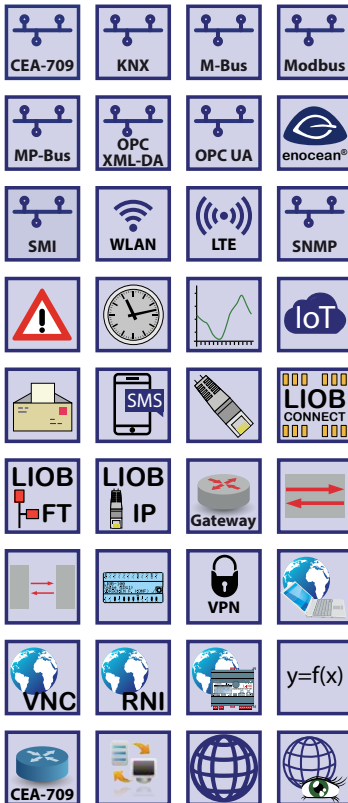

The L-INX Automation Servers LINX-102 and LINX-103 (successors of LINX-100, LINX-101) can host user specific graphical pages for the visualization of information from LonMark systems via LWEB-900 (Building Management) or LWEB-802/803. They can integrate physical I/Os through LIOB I/O Modules via LIOB-Connect, LIOB-FT, or LIOB-IP. Local operation and override is provided by the built-in jog dial and the backlit display (128x64 pixels). Device and data point information is shown on the display via symbols and in text format.

LonMark Systems can be integrated via IP-852 (Ethernet/IP) or TP/FT-10. In addition, the Automation Servers provides connectivity to concurrently integrate KNX, Modbus, and M-Bus and connect as a gateway data points of different technological origin. Optionally, mathematical objects can be applied within a connection to calculate the data point output values depending on the formula used. Depending on the type, the Automaton Servers feature an integrated Remote Network Interface (LINX-102) or an integrated IP-852 router providing the complete feature set of corresponding L-IP devices (LINX-103).

The gateway functionality allows data communication between all communication technologies available on the device. Different technology data points are mapped through Local Connections on the device. The mapping of different technology data points on distributed devices is supported by Global Connections. L-INX Automation Servers also support Smart Auto-Connect™ – the automatic generation of connections to substantially reduce engineering efforts and cost. All technology data points are automatically created as OPC XML-DA and OPC UA data points.

Each L-INX Automation Server is equipped with two Ethernet ports. It can either be configured to use the internal switch to interconnect the two ports or every port is configured to work in a separate IP network.

When the Ethernet ports are configured for two separate IP networks, one port can be connected for instance to a WAN (Wide Area Network) with enabled network security (HTTPS) while the second port can be configured to be connected to an insecure network (LAN) where the standard building automation protocols like BACnet/IP, LON/IP, or Modbus TCP are present. These devices also feature firewall functionality of course to isolate particular protocols or services between the ports. The built-in VPN function provides for simple VPN setup and secure access to remote sites. The LTE-800 interface enables wireless access to remote sites through a mobile carrier.

Using the internal switch, a daisy chained line topology of up to 20 devices can be built, which reduces costs for network installation. The IP switch also allows the setup of a redundant Ethernet installation (ring topology), which increases reliability. The redundant Ethernet topology is enabled by the Rapid Spanning Tree Protocol (RSTP), which is supported by most managed switches.

The L-INX devices provide fully featured AST™ functionality (Alarming, Scheduling, and Trending) and can be integrated perfectly into the L-WEB System.

IoT Integration

The IoT function (Node.js) allows connecting the system to almost any cloud service, either for uploading historical data to analytics services, telemetry using MQTT, delivering alarm messages to alarm processing services or operating parts of the control system over a cloud service (e.g., scheduling based on Web calendars or booking systems). Processing Internet information such as weather data in forecast-based control is also possible. Finally, the JavaScript kernel also allows implementing serial protocols to non-standard equipment in primary plant control.

L-INX Automation Server

LINX-102, LINX-103

Features

- Visualization of customized graphical pages through LWEB-900 (Building Management), LWEB-803 (Monitoring and Control), or LWEB-802 (Web Browser)
- Stores customized graphical pages
- Extension with physical inputs and outputs using L-IOB I/O Modules (LIOB-10x/11x, LIOB-15x, and LIOB-45x)
- 128x64 graphic display with backlight
- Local and remote access to information about device status and data points
- Manual operation using the jog dial or VNC client
- Alarming, Scheduling, and Trending (AST™)
- Node.js support* for easy IoT integration (e.g. Google calendar, MQTT, Alexa & friends, multimedia equipment,...)
- Event-driven e-mail notification
- Math objects to execute mathematical operations on data points
- Integrated OPC XML-DA and OPC UA server
- Dual Ethernet/IP interface
- Access to network statistics
- Compliant with CEA-709, CEA-852, and ISO/IEC 14908 Standard (LonMark System)
- Support TP/FT-10 or IP-852 (Ethernet/IP)
- Support of dynamically created or static NVs
- Support of user-defined NVs (UNVTs) and Configuration Properties (SCPTs, UCPTs)
- Remote Network Interface (RNI) with 2 MNI devices (LINX-102 only)
- Integrated IP-852 to TP/FT-10 Router (LINX-103 only)
- KNXnet/IP, connection to KNX TP1 through LKNX-300 Interface
- M-Bus Master according to EN 13757-3, connection via optional M-Bus Converter (L-MBUS20 or L-MBUS80)
- Modbus TCP and Modbus RTU (Master or Slave)
- Gateway functions including Smart Auto-Connect™
- Integrated web server for device configuration and monitoring data points
- Configurable via Ethernet/IP or TP/FT-10
- Connection to EnOcean wireless devices via LENO-80x Interface
- Supports SMI (Standard Motor Interface) through LSMI-80x
- Supports WLAN through LWLAN-800 Interface
- Supports LTE through LTE-800 Interface
- Supports MP-Bus through LMPBUS-804 Interface
- Supports RS-232 through LRS232-802 Interface
- Stores user-defined project documentation

Specifications

Dimensions (mm)	107 x 100 x 75 (L x W x H), DIM045	
Installation	DIN rail mounting following DIN 43880, top hat rail EN 50022	
Power supply	24 VDC / 24 VAC ±10 %, typ. 2.5 W	
Operating conditions	0 °C to 50 °C, 10 – 90 % RH, noncondensing, degree of protection: IP40, IP20 (terminals)	
Interfaces	2 x Ethernet (100Base-T): OPC XML-DA, OPC UA, LonMark IP-852**, LIOB-IP, KNXnet/IP, Modbus TCP (Master or Slave), HTTP, FTP, SSH, HTTPS, Firewall, VNC, SNMP 1 x LIOB-Connect 1 x TP/FT-10** (LonMark system) together with LIOB-FT	1 x RS-485 (ANSI TIA/EIA-485): Modbus RTU/ASCII (Master or Slave) 1 x EXT: M-Bus, Master EN 13757-3 (needs L-MBUS20 or L-MBUS80) or KNX TP1 (needs LKNX-300) or SMI (needs LSMI-800) 2 x USB-A: WLAN (needs LWLAN-800), EnOcean (needs LENO-80x), SMI (needs LSMI-804) LTE (needs LTE-800) MP-Bus (needs LMPBUS-804)
	LINX-102: ** Either LonMark IP-852 or TP/FT-10 LINX-103: ** Router between LonMark IP-852 and TP/FT-10	
L-IOB I/O Modules	Up to 8 L-IOB I/O Modules in any combination of type LIOB-10x/11x, LIOB-15x, and LIOB-45x	
Remote Network Interface	1 RNI with 2 MNI devices (LINX-102 only)	
CEA-709 Router	1 (LINX-103 only)	
Tools	L-INX Configurator	

*requires L-IOT1 software license

Resource limits			
Total number of data points	10 000	Math objects	100
OPC data points	2 000	Alarm logs	10
Network variables (NVs)	1 000	M-Bus data points	1 000
Alias NVs	1 000	Modbus data points	2 000
External NVs (polling)	1 000	KNX TP1 data points	250
Address table entries	1 000 (non-ECS mode: 15)	KNXnet/IP data points	250
LonMark Calendars	1 (25 calendar patterns)	Connections (Local / Global)	1 000 / 250
LonMark Schedulers	100	Number of L-WEB clients	32 (simultaneously)
LonMark Alarm Servers	1	L-IOB I/O Modules	8
Trend logs	256 (13 000 000 entries, ≈ 200 MB)	Number of EnOcean devices	25
Total trended data points	256	EnOcean data points	250
E-mail templates	100	SMI devices (per channel)	16
MP-Bus devices (per channel)	16		

Order number	Product description
LINX-102	CEA-709 Automation Server with LIOB-Connect and built-in Remote Network Interface (RNI)
LINX-103	CEA-709 Automation Server with LIOB-Connect and built-in IP-852 Router
LIOB-A2	L-IOB Adapter 2 to split the LIOB-Connect bus using 4-wire cables
LIOB-A4	L-IOB Adapter 4 to split the LIOB-Connect bus using RJ45 network cables
LIOB-A5	L-IOB Adapter 5 to terminate the LIOB-Connect bus
LIOB-100	LIOB-Connect I/O Module: 8 UI, 2 DI, 2 AO, 9 DO (5 x Relay 6 A, 4 x Triac 0.5 A)
LIOB-101	LIOB-Connect I/O Module: 8 UI, 16 DI
LIOB-102	LIOB-Connect I/O Module: 6 UI, 6 AO, 8 DO (8 x Relay 6 A)
LIOB-103	LIOB-Connect I/O Module: 6 UI, 6 AO, 5 DO (5 x Relay 16 A)
LIOB-110	LIOB-Connect I/O Module: 20 Universal I/O (IO)
LIOB-112	LIOB-Connect I/O Module: 40 Universal I/O (12 optionally with 4-20 mA Current Output)
LIOB-150	LIOB-FT I/O Module: 8 UI, 2 DI, 2 AO, 8 DO (4 x Relay 6 A, 4 x Triac 0.5 A)
LIOB-151	LIOB-FT I/O Module: 8 UI, 12 DI
LIOB-152	LIOB-FT I/O Module: 6 UI, 6 AO, 8 DO (8 x Relay 6 A)
LIOB-153	LIOB-FT I/O Module: 6 UI, 6 AO, 5 DO (4 x Relay 16 A, 1 x Relay 6 A)
LIOB-154	LIOB-FT I/O Module: 7 UI, 4 AO, 7 DO (5 x Relay 6 A, 2 x Triac 0.5 A), 1 Pressure Sensor
LIOB-450	LIOB-IP852 I/O Module: 8 UI, 2 DI, 2 AO, 8 DO (4 x Relay 6 A, 4 x Triac 0.5 A)
LIOB-451	LIOB-IP852 I/O Module: 8 UI, 12 DI
LIOB-452	LIOB-IP852 I/O Module: 6 UI, 6 AO, 8 DO (8 x Relay 6 A)
LIOB-453	LIOB-IP852 I/O Module: 6 UI, 6 AO, 5 DO (4 x Relay 16 A, 1 x Relay 6 A)
LIOB-454	LIOB-IP852 I/O Module: 7 UI, 4 AO, 7 DO (5 x Relay 6 A, 2 x Triac 0.5 A), 1 Pressure Sensor
L-IOT1	Add-on Software License to enable IoT functionality on LIOB-585/586/587/588/589/59x, LIOB-AIR, and LINX-102/103/202/203
LPOW-2415A	LIOB-Connect power supply unit, 24 VDC, 15 W
LPOW-2415B	Power supply unit with power connector 24 VDC, 15 W
L-MBUS20	M-Bus Level Converter, Interface for up to 20 M-Bus devices
L-MBUS80	M-Bus Level Converter, Interface for up to 80 M-Bus devices
LKNX-300	KNX interface to connect KNX TP1 devices
LENO-800	EnOcean Interface 868 MHz Europe
LENO-801	EnOcean Interface 902 MHz USA/Canada
LENO-802	EnOcean Interface 928 MHz Japan
LWLAN-800	Wireless LAN Interface IEEE 802.11bgn
LMPBUS-804	MP-Bus interface for 16 devices per channel, up to 4 channels
LSMI-800	Standard Motor Interface for 16 motors via EXT port
LSMI-804	Standard Motor Interface for 64 motors, 4 SMI channels via USB
LTE-800	LTE Interface
LRS232-802	USB to 2 x RS-232 Interface

Features

- Visualization of customized graphical pages through LWEB-900 (Building Management), LWEB-803 (Monitoring and Control), or LWEB-802 (Web Browser)
- Stores customized graphical pages
- Extension with physical inputs and outputs using L-IOB I/O Modules (LIOB-10x, LIOB-15x, and LIOB-55x)
- 128x64 graphic display with backlight
- Local and remote access to information about device status and data points
- Manual operation using the jog dial or VNC client
- Alarming, Scheduling, and Trending (AST™)
- Node.js support* for easy IoT integration (e.g. Google calendar, MQTT, Alexa & friends, multimedia equipment,...)
- Event-driven e-mail notification
- Math objects to execute mathematical operations on data points
- Integrated OPC XML-DA and OPC UA server
- Dual Ethernet/IP interface
- Access to network statistics
- Compliant with ANSI/ASHRAE 135-2012 and ISO 16484-5:2012 standard
- Supports BACnet/IP, BACnet/SC or BACnet MS/TP
- BACnet Client Function (Write Property, Read Property, COV Subscription)
- BACnet Client Configuration with configuration tool (scan and EDE import)
- B-BC (BACnet Building Controller) functionality, BTL certified
- Integrated BACnet/ IP to BACnet/SC and BACnet MS/ TP Router including BBMD as well as Slave-Proxy functionality (LINX-203 only)
- KNXnet/IP, connection to KNX TP1 through LKNX-300 Interface
- M-Bus Master according to EN 13757-3, connection via optional M-Bus Converter (L-MBUS20 or L-MBUS80)
- Modbus TCP and Modbus RTU (Master or Slave)
- Gateway functions including Smart Auto-Connect™
- Integrated web server for device configuration and monitoring data points
- Configurable via Ethernet/IP
- Connection to EnOcean wireless devices via LENO-80x Interface
- Supports SMI (Standard Motor Interface) through LSMI-80x
- Supports WLAN through LWLAN-800 Interface
- Supports LTE through LTE-800 Interface
- Supports MP-Bus through LMPBUS-804 Interface
- Supports RS-232 through LRS232-802 Interface
- Stores user-defined project documentation

Specifications

Dimensions (mm)	107 x 100 x 75 (L x W x H), DIM045	
Installation	DIN rail mounting following DIN 43880, top hat rail EN 50022	
Power supply	24 VDC / 24 VAC ±10 %, typ. 2.5 W	
Operating conditions	0 °C to 50 °C, 10 – 90 % RH, noncondensing, degree of protection: IP40, IP20 (terminals)	
Interfaces	2 x Ethernet (100Base-T): OPC XML-DA, OPC UA, BACnet/IP**, BACnet/SC** LIOB-IP, KNXnet/IP, Modbus TCP (Master or Slave), HTTP, FTP, SSH, HTTPS, Firewall, VNC, SNMP 1 x LIOB-Connect 1 x LIOB-FT 1 x RS-485 (ANSI TIA/EIA-485): BACnet MS/TP** or Modbus RTU/ASCII (Master or Slave)	1 x EXT: M-Bus, Master EN 13757-3 (needs L-MBUS20 or L-MBUS80) or KNX TP1 (needs LKNX-300) or SMI (needs LSMI-800) 2 x USB-A: WLAN (needs LWLAN-800), EnOcean (needs LENO-80x) SMI (needs LSMI-804) LTE (needs LTE-800) MP-Bus (needs LMPBUS-804)
	LINX-202: **Either BACnet/IP, BACnet/SC or BACnet MS/TP LINX-203: ** Router between BACnet/IP, BACnet/SC and BACnet MS/TP	
L-IOB I/O Modules	Up to 8 L-IOB I/O Modules in any combination of type LIOB-10x, LIOB-15x, and LIOB-55x	
BACnet/IP Router	1 (LINX-203 only)	
Tools	L-INX Configurator	

*requires L-IOT1 software license

LINX-202, LINX-203

Resource limits			
Total number of data points	10 000	Alarm logs	10
OPC data points	2 000	M-Bus data points	1 000
BACnet objects	750 (analog, binary, multi-state)	Modbus data points	2 000
BACnet client mappings	750	KNX TP1 data points	250
BACnet calendar objects	25	KNXnet/IP data points	250
BACnet scheduler objects	100 (64 data points per object)	Connections (Local / Global)	1 000 / 250
BACnet notification classes	32	Number of L-WEB clients	32 (simultaneously)
Trend logs (BACnet or generic)	256 (13 000 000 entries, ≈ 200 MB)	L-IOB I/O Modules	8
Total trended data points	256	Number of EnOcean devices	25
E-mail templates	100	EnOcean data points	250
Math objects	100	SMI devices (per channel)	16
MP-Bus devices (per channel)	16		

Order number	Product description
LINX-202	BACnet Automation Server with LIOB-Connect, B-BC
LINX-203	BACnet Automation Server with LIOB-Connect, B-BC, and built-in BACnet/IP, BACnet/SC to MS/TP Router
LIOB-A2	L-IOB Adapter 2 to split the LIOB-Connect bus using 4-wire cables
LIOB-A4	L-IOB Adapter 4 to split the LIOB-Connect bus using RJ45 network cables
LIOB-A5	L-IOB Adapter 5 to terminate the LIOB-Connect bus
LIOB-100	LIOB-Connect I/O Module: 8 UI, 2 DI, 2 AO, 9 DO (5 x Relay 6 A, 4 x Triac 0.5 A)
LIOB-101	LIOB-Connect I/O Module: 8 UI, 16 DI
LIOB-102	LIOB-Connect I/O Module: 6 UI, 6 AO, 8 DO (8 x Relay 6 A)
LIOB-103	LIOB-Connect I/O Module: 6 UI, 6 AO, 5 DO (5 x Relay 16 A)
LIOB-110	LIOB-Connect I/O Module: 20 Universal I/O (IO)
LIOB-112	LIOB-Connect I/O Module: 40 Universal I/O (12 optionally with 4-20 mA Current Output)
LIOB-150	LIOB-FT I/O Module: 8 UI, 2 DI, 2 AO, 8 DO (4 x Relay 6 A, 4 x Triac 0.5 A)
LIOB-151	LIOB-FT I/O Module: 8 UI, 12 DI
LIOB-152	LIOB-FT I/O Module: 6 UI, 6 AO, 8 DO (8 x Relay 6 A)
LIOB-153	LIOB-FT I/O Module: 6 UI, 6 AO, 5 DO (4 x Relay 16 A, 1 x Relay 6 A)
LIOB-154	LIOB-FT I/O Module: 7 UI, 4 AO, 7 DO (5 x Relay 6 A, 2 x Triac 0.5 A), 1 Pressure Sensor
LIOB-550	LIOB-BIP I/O Module: 8 UI, 2 DI, 2 AO, 8 DO (4 x Relay 6 A, 4 x Triac 0.5 A)
LIOB-551	LIOB-BIP I/O Module: 8 UI, 12 DI
LIOB-552	LIOB-BIP I/O Module: 6 UI, 6 AO, 8 DO (8 x Relay 6 A)
LIOB-553	LIOB-BIP I/O Module: 6 UI, 6 AO, 5 DO (4 x Relay 16 A, 1 x Relay 6 A)
LIOB-554	LIOB-BIP I/O Module: 7 UI, 4 AO, 7 DO (5 x Relay 6 A, 2 x Triac 0.5 A), 1 Pressure Sensor
L-IOT1	Add-on Software License to enable IoT functionality on LIOB-585/586/587/588/589/59x, LIOB-AIR, and LINX-102/103/202/203
LPOW-2415A	LIOB-Connect power supply unit, 24 VDC, 15 W
LPOW-2415B	Power supply unit with power connector 24 VDC, 15 W
L-MBUS20	M-Bus Level Converter, Interface for up to 20 M-Bus devices
L-MBUS80	M-Bus Level Converter, Interface for up to 80 M-Bus devices
LKNX-300	KNX interface to connect KNX TP1 devices
LENO-800	EnOcean Interface 868 MHz Europe
LENO-801	EnOcean Interface 902 MHz USA/Canada
LENO-802	EnOcean Interface 928 MHz Japan
LWLAN-800	Wireless LAN Interface IEEE 802.11bgn
LMPBUS-804	MP-Bus interface for 16 devices per channel, up to 4 channels
LSMI-800	Standard Motor Interface for 16 motors via EXT port
LSMI-804	Standard Motor Interface for 64 motors, 4 SMI channels via USB
LTE-800	LTE Interface
LRS232-802	USB to 2 x RS-232 Interface

Graphical Operator Panels LPAD-7, L-VIS & L-STAT



LPAD-7 Touch Panels

Control is just a touch away!

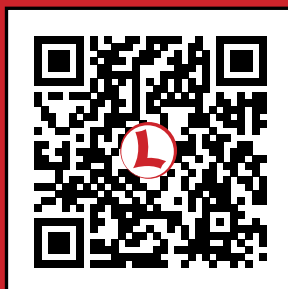

Accessories Interfaces Routers, NIC L-DALI Gateways L-IOB L-INX L-ROC L-WEB, L-STUDIO Functions

- ✓ BACnet
- ✓ CEA-709
- KNX

- ✓ Modbus
- M-Bus
- ✓ OPC

Datasheet #89069726



LPAD-7 Touch Panels for BACnet, EnOcean, LonMark, Modbus, Bluetooth, OPC XML / DA and OPC UA networks are ideally suited for visualization and operation in building automation. LPAD-7 Touch Panels can be used as room operator panels, network thermostats, room controller with integrated capacitive touch screen for single offices, conference rooms, hotel rooms, cabins on cruise ships and private homes. The L-PAD/L-VIS/L-WEB configurator can be used to customize the pages and create the page navigation. LPAD-7 touch panels run on a powerful quad core CPU with extremely low power consumption. The LPAD-7 is designed for the best possible security measures with regular firmware updates over many years' lifetime.

LPAD-7 impresses with its timeless design, harmonic integration into modern and historical architecture, and with its extremely user-friendly concept. The all view IPS display can be mounted horizontally or vertically. With its only 21 mm thickness it can be mounted on wall.

Integrated Sensor

The LPAD-7 offers a variety of built-in sensors to measure temperature, humidity, illuminance, and to detect presence. The IR receiver detects commands from an IR remote control. The proximity sensor turns on the back light of the display. An optional built-in 1.3 Mpx camera with 80° viewing angle streams videos from the monitored area.

The integrated real-time clock is powered by a rechargeable capacitor and has a ten-day power-reserve.

Playback of Audio Files and Streams

The LPAD-7 integrated sound system plays MP3, WAV, and MP3 streams (for example web radio). The playback will be started or stopped by the respective action object. The action object is linked to one of the available audio files or to the URL of an MP3 stream.

Programming

Some LPAD-7 models can be programmed in IEC 61499 with the L-ROC room automation library or in IEC 61131-3 with the L-STUDIO building automation library. In this configuration the LPAD-7 can act as the room controller and user interface in one device. Wireless sensors and actuators in the room communicate via Bluetooth Mesh with the LPAD-7 room controller.

IoT Integration

The IoT function (Node.js) included in some LPAD-7 models allows connecting the system to almost any cloud service, either for uploading historical data to analytics services, telemetry using MQTT, delivering alarm messages to alarm processing services or operating parts of the control system over a cloud service (e.g., scheduling based on Web calendars or booking systems). Processing Internet information such as weather data in forecast-based control is also possible. Finally, the JavaScript kernel also allows implementing serial protocols to non-standard equipment in primary plant control.



Portrait mounting



Landscape mounting

Communication

LPAD-7 communicates OPC XML/DA with L-ROC room controller and the LWEB-900 building management system.

LPAD-7 communicates with BACnet networks via BACnet/IP, BACnet/SC or BACnet MS/TP. BACnet enabled LPAD-7 Touch Panels implement the BACnet Building Controller (B-BC) profile and are BTL certified. They include a fully featured built-in BACnet/IP, BACnet/SC and MS/TP router with BBMD (BACnet Broadcast Management Device) and slave proxy functionality. For BACnet MS/TP communication the optional LPAD7-SOCKET1 / LPAD7-SOCKET2 / LPAD7-SOCKET3 / LPAD7-SOCKET4 socket board with RS-485 interface is required.

LPAD-7 Touch Panels communicate with LonMark Systems via IP-852 (Ethernet/IP) or TP/FT-10 channels via the optional LPAD7-SOCKET2 socket board.

LPAD-7 Touch Panels communicate Modbus either as Master or Slave. For this purpose, Modbus TCP is supported, and Modbus RTU/ASCII is available via the optional LPAD7-SOCKET1, LPAD7-SOCKET2, LPAD7-SOCKET3 or LPAD7-SOCKET4 socket board with RS-485 interface.

An EnOcean option allows integration of EnOcean sensor and actuator devices into the LPAD-7. This option requires the LPAD7-SOCKET3 or the LPAD7-SOCKET4 product.

Connectivity

LPAD-7 devices are equipped with two Ethernet ports. They can either be configured to use the internal switch to connect the two ports together or every port is configured to work in a separate IP network. The IP switch can also setup an Ethernet ring topology with the RSTP protocol to increase network reliability.

The built-in WiFi interface integrates LPAD-7 devices into an existing WLAN infrastructure.

The Bluetooth feature allows communication with Bluetooth enabled devices in a room.

Power Supply

Every LPAD-7 Touch Panel can be supplied with 24 V DC or through PoE (Power over Ethernet). If the LPAD-7 is used together with the LPAD7-SOCKET1, LPAD7-SOCKET2, LPAD7-SOCKET3, LPAD7-SOCKET4 or LPAD7-SOCKET5 either 24 V DC or 24 V AC supply voltage can be used.

Order Information

There are different versions of the LPAD-7 available. Please check the following tables for the various product features. Valid order numbers are:

LPAD7-30G2, LPAD7-31G2, LPAD7-41G2

LPAD7-30G3, LPAD7-31G3, LPAD7-41G3

Every LPAD-7 requires an LPAD7-SOCKETx product that must be ordered separately. Depending on the model these sockets may add communication interfaces and I/O terminals.

Features

- High resolution IPS touch display with dimmable backlight
- Glass front and capacitive touch
- Portrait or landscape mounting
- Device configuration and graphical page creation with the L-PAD/L-VIS/L-WEB configuration tool free of charge
- Room controller for up to 2 room segments (LPAD7-31Gx and LPAD7-41Gx only)
- Supports all popular graphic file formats such as GIF, JPG, BMP, TIFF, PNG, MNG, ICO
- Support of SVG vector graphics
- Supports popular font types such as TrueType, Type-1, BDF, PCF, and OTF
- Supports Unicode text and complex writing systems
- Built-in WLAN
- Built-in Bluetooth
- Built-in OPC UA and OPC XML-DA server
- Built-in OPC XML-DA client
- Integration of EnOcean sensor and actuator devices
- Alarming, Scheduling, and Trending (AST™)
- Node.js support for easy IoT integration (e.g. Google calendar, MQTT, Alexa & friends, multimedia equipment,...)
- Event-driven e-mail notification
- Math objects to execute mathematical operations on data points
- IEC 61499 / 61131-3 programmable
- Compliant with CEA-709, CEA-852, and ISO/IEC 14908 Standard (LonMark System)
- Supports CEA-709 TP/FT-10 or IP-852 (Ethernet/IP)
- Compliant with ANSI/ASHRAE 135-2012 and ISO 16484-5:2012 standard
- Supports BACnet/IP, BACnet/SC and BACnet MS/TP
- BACnet Client Function (Write Property, Read Property, COV Subscription)
- BACnet Client Configuration with configuration tool (scan and EDE import)
- B-BC (BACnet Building Controller), BTL certified
- Integrated BACnet/IP, BACnet/SC to BACnet MS/TP Router
- BBMD (BACnet Broadcast Management Device)
- Modbus TCP and Modbus RTU/ASCII (Master or Slave)
- Integrated web server for device configuration and monitoring data points
- Access to network statistics
- Configurable via Ethernet/IP
- Playback of audio files and streams
- PoE Class 3 power supply
- Dual Ethernet/IP interface
- Integrated proximity sensor (TOF)
- Integrated temperature & humidity sensor
- Integrated illuminance sensor
- Integrated IR-sensor
- Integrated real-time clock (10-day power-reserve)
- Integrated 1.3 Mpx camera (optional)
- Supports VPN

Specifications of the sensors

Temperature measurement	Range: +10 – 45 °C, resolution: 0.1 °C, accuracy: ±0.5 °C (5 – 60 °C)
Relative Humidity (R.H.)	Range: 20 % – 80 % R.H. resolution: 0.1 % R.H., accuracy: ±2 % R.H. @ 25 °C, 20 % – 80 % R.H.
Infrared receiver	NEC protocol (Apple Remote compatible)
Proximity	Time of flight proximity sensor to turn on backlight.
Illuminance measurement	0 – 4000 lux, resolution: 0.125 lux; automatic display backlight adjustment depending on the ambient light
Camera	Built-in 1.3 Mpx camera, 1296 x 976, 80° view angle

LPAD-7

Specifications			
Type	LPAD7-30G2 LPAD7-30G3	LPAD7-31G2 LPAD7-31G3	LPAD7-41G2 LPAD7-41G3
Screen size	7" (178 mm)	7" (178 mm)	7" (178 mm)
Dimensions (mm)	180 x 112.2 x 21 (L x W x H), DIM068	180 x 112.2 x 21 (L x W x H), DIM068	180 x 112.2 x 21 (L x W x H), DIM068
Display resolution	1024 x 600, 16.7 million colors	1024 x 600, 16.7 million colors	1024 x 600, 16.7 million colors
Interfaces	2 x Ethernet, Switch, 1 x WLAN 1 x Bluetooth OPC UA (server) OPC XML-DA, HTTP, HTTPS, FTP, SSH, SMTP, NTP, VNC, VPN LonMark IP-852*, LonMark TP/FT-10*, EnOcean*	2 x Ethernet, Switch, 1 x WLAN 1 x Bluetooth OPC UA (server) OPC XML-DA, HTTP, HTTPS, FTP, SSH, SMTP, NTP, VNC, VPN LonMark IP-852*, LonMark TP/FT-10*, EnOcean*, BACnet/IP, BACnet/SC BACnet MS/TP*, Modbus TCP, Modbus RTU/ASCII*	2 x Ethernet, Switch, 1 x WLAN 1 x Bluetooth OPC UA (server) OPC XML-DA, HTTP, HTTPS, FTP, SSH, SMTP, NTP, VNC, VPN LonMark IP-852*, LonMark TP/FT-10*, EnOcean*, BACnet/IP, BACnet/SC BACnet MS/TP*, Modbus TCP, Modbus RTU/ASCII*
	<i>*Note: some features require LPAD7-SOCKET1, LPAD7-SOCKET2, LPAD7-SOCKET3, or LPAD7-SOCKET4</i>	<i>*Note: some features require LPAD7-SOCKET1, LPAD7-SOCKET2, LPAD7-SOCKET3, or LPAD7-SOCKET4</i>	<i>*Note: some features require LPAD7-SOCKET1, LPAD7-SOCKET2, LPAD7-SOCKET3, or LPAD7-SOCKET4</i>
Sensors	Proximity (TOF), Temperature & Humidity, Illuminance, IR receiver	Proximity (TOF), Temperature & Humidity, Illuminance, IR receiver	Proximity (TOF), Temperature & Humidity, Illuminance, IR receiver, Camera 1.3 Mpx
Real-time clock	Powered by rechargeable capacitor, 10-day power reserve		
Power supply	PoE class 3, 24 VDC ±10 %, 3 W, backlight on: 6 W	PoE class 3, 24 VDC ±10 %, 3 W, backlight on: 6 W	PoE class 3, 24 VDC ±10 %, 3 W, backlight on: 6 W
Operating conditions	+10 °C to 45 °C, 10-90 % RH, noncondensing	+10 °C to 45 °C, 10-90 % RH, noncondensing	+10 °C to 45 °C, 10-90 % RH, noncondensing
Degree of protection	IP20	IP20	IP20
Tools	L-PAD/L-VIS/L-WEB Configurator, LWEB-900, L-STUDIO	L-PAD/L-VIS/L-WEB Configurator, LWEB-900, L-STUDIO	L-PAD/L-VIS/L-WEB Configurator, LWEB-900, L-STUDIO
Programming	-	Node.js, Node-RED, L-STUDIO (IEC 61499/IEC 61131-3)	Node.js, Node-RED, L-STUDIO (IEC 61499/IEC 61131-3)
BTL certification	-	BTL certified	BTL certified
Max. number of Rooms/Segments	-	2	2

Functions
L-WEB, L-STUDIO
L-ROC
L-INX
L-IOB
Gateways
LPAD-7, L-VIS, L-STAT
L-DALI
Routers, NIC
Interfaces
Accessories

Specifications						
Type	LPAD7-SOCKET0	LPAD7-SOCKET1	LPAD7-SOCKET2	LPAD7-SOCKET3	LPAD7-SOCKET4	LPAD7-SOCKET5
General	Mounting socket, DIM069,	Mounting socket, DIM069, 24 V AC/DC input	Mounting socket, DIM069, 24 V AC/DC input	Mounting socket, DIM069, 24 V AC/DC input	Mounting socket, DIM069, 24 V AC/DC input	Mounting socket, DIM069, 24 V AC/DC input
Interfaces	-	6 x Relay 2A, 24 V, 7 x Universal I/O (IO), 1 x RS-485	1 x LonMark TP/FT-10, IP-852, 1 x RS-485, 3 x digital input (dry contact, not protected against overvoltage)	1 x EnOcean 868 MHz, 1 x RS-485, 3 x digital input (dry contact, not protected against overvoltage)	1 x EnOcean 902 MHz, 1 x RS-485, 3 x digital input (dry contact, not protected against overvoltage)	-
EnOcean Alliance certification	-	-	-	EnOcean Alliance certified	EnOcean Alliance certified	-

Resource limits			
OPC data points	10 000	BACnet scheduler objects	200 (64 data points per object)
Modbus data points	2 000	BACnet notification classes	32
VNC clients	16	E-mail templates	100
Network variables (NVs)	1 000	Math objects	2 000
Alias NVs	1 000	Alarm logs	100
Address table entries	524 (non-ECS mode: 15)	Trend logs	512 (4 000 000 entries, ≈ 60 MB)
LonMark Calendars	1 (100 calendar patterns)	Total trended data points	512
LonMark Schedulers	200	Connections (Local/Global)	2 000/250
LonMark Alarm Servers	1	Number of L-WEB clients	32 (simultaneously)
BACnet server objects	1 000	EnOcean devices	10
BACnet calendar objects	25	EnOcean data points	100

Order number	Product description
LPAD7-30G2	Touch Panel, Dual Ethernet, WLAN, Bluetooth, proximity sensor, temperature and humidity sensor, illuminance sensor, IR receiver, black front
LPAD7-30G3	Touch Panel, Dual Ethernet, WLAN, Bluetooth, proximity sensor, temperature and humidity sensor, illuminance sensor, IR receiver, white front
LPAD7-31G2	Programmable Touch Panel, Dual Ethernet, WLAN, Bluetooth, proximity sensor, temperature and humidity sensor, illuminance sensor, IR receiver, BACnet, 61499, black front
LPAD7-31G3	Programmable Touch Panel, Dual Ethernet, WLAN, Bluetooth, proximity sensor, temperature and humidity sensor, illuminance sensor, IR receiver, BACnet, 61499, white front
LPAD7-41G2	Programmable Touch Panel, Dual Ethernet, WLAN, Bluetooth, proximity sensor, temperature and humidity sensor, illuminance sensor, IR receiver, BACnet, 61499, camera, black front
LPAD7-41G3	Programmable Touch Panel, Dual Ethernet, WLAN, Bluetooth, proximity sensor, temperature and humidity sensor, illuminance sensor, IR receiver, BACnet, 61499, camera, white front
LPAD7-SOCKET0	Mounting Socket
LPAD7-SOCKET1	Mounting Socket, 24 V AC/DC input, 6 x Relay 2A, 24 V, 7 x Universal I/O (IO), 1 x RS-485 interface
LPAD7-SOCKET2	Mounting Socket, 24 V AC/DC input, 1 x LonMark TP/FT-10 interface, 1 x RS-485 interface, 3 x digital input
LPAD7-SOCKET3	Mounting Socket, 24 V AC/DC input, 1 x EnOcean 868 MHz, 1 x RS-485 interface, 3 x digital input
LPAD7-SOCKET4	Mounting Socket, 24 V AC/DC input, 1 x EnOcean 902 MHz, 1 x RS-485 interface, 3 x digital input
LPAD7-SOCKET5	Mounting Socket, 24 V AC/DC input
L-STUDIO	Development and integration platform for programmable LOYTEC controllers
LOYBT-TEMP1	Bluetooth Mesh temperature sensor (5 pieces per package)
LPAD7-STAND1	Demo Stand for LPAD-7

L-VIS Touch Panels

L-VIS Overview

L-VIS Touch Panels for visualization and operation of information in LonMark, BACnet, and Modbus networks are not only perfectly suitable for local operation, they also offer various remote access options that can be used simultaneously if required:

- VNC: The graphical user interface can be accessed via the built-in VNC server by a commercial or free VNC-Client.
- LWEB-803: The graphical user interface allows remote access to the graphical projects on the L-VIS Touch Panel from a Microsoft Windows PC. Communication is done by using web services – smoothly across firewalls and NAT routers.
- LWEB-802: The platform-independent graphical user interface enables remote access to the graphical projects on the L-VIS Touch Panel by a standard web browser. The use of HTML5 and JavaScript allows applying smart phones and tablets also.
- LWEB-900: L-VIS Touch Panels integrate perfectly into the L-WEB System.

Various remote access options, alarming, scheduling, trending, and e-mails sent on a timely basis or triggered by events offer amazing flexibility and versatility. Depending on the interface, L-VIS Touch Panels behave compliant to LonMark Systems or BACnet networks.

Furthermore, the L-VIS Touch Panel can be used as an OPC XML-DA client to LOYTEC devices (OPC XML-DA server) in the Ethernet/IP network. If connected to a LOYTEC device, information from KNX, Modbus and M-Bus networks can be integrated and visualized in addition to information from LonMark Systems or BACnet networks.

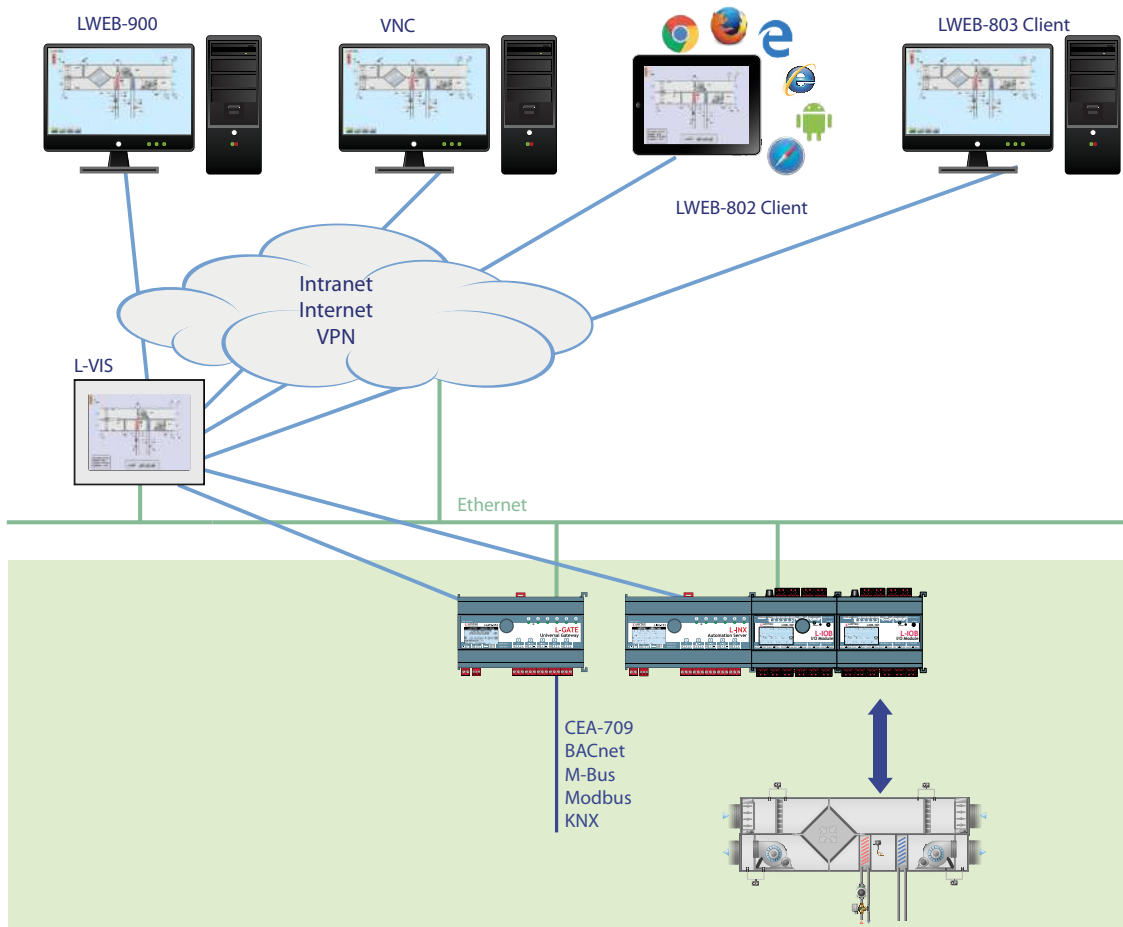

- ✓ BACnet
- ✓ CEA-709
- KNX

- ✓ Modbus
- M-Bus
- ✓ OPC

LVIS-3ME7-Gx/3ME12-A1/3ME15-A1/3ME15-Gx

Datasheet #89033423



L-VIS Touch Panels for LonMark, BACnet, and Modbus networks are ideally suited for visualization and operation of various applications in building automation. L-VIS Touch Panels visualize building systems, can be used as room operator panels, in hospital operation or isolation rooms, conference and reception areas. The fully customizable user screens can show dynamic pages that are easy to navigate. L-VIS Touch Panels make use of an extremely low power embedded controller platform and operating system. This makes L-VIS resistant against problems when re-booting after power outage and also against any viruses.

L-VIS impresses with its timeless design, harmonic integration into modern and historical architecture, and with its extremely user friendly concept. The shallow installation depth and low thermal power loss allow mounting in almost any location.

Different Sizes

L-VIS Touch Panels are available in the following variations:

LVIS-3ME7-Gx	7" Touch Display Frameless glass front and capacitive touch	800 x 480	262 144 colors
LVIS-3ME12-A1	12.1" Touch Display Aluminum frame with anodized finish	800 x 600	262 144 colors
LVIS-3ME15-A1	15" Touch Display Aluminum frame with anodized finish	1024 x 768	262 144 colors
LVIS-3ME15-Gx	15" Touch Display Frameless glass front and capacitive touch	1024 x 768	262 144 colors

IoT Integration

The IoT function (Node.js) allows connecting the system to almost any cloud service, either for uploading historical data to analytics services, telemetry using MQTT, delivering alarm messages to alarm processing services or operating parts of the control system over a cloud service (e.g., scheduling based on Web calendars or booking systems). Processing Internet information such as weather data in forecast-based control is also possible. Finally, the JavaScript kernel also allows implementing serial protocols to non-standard equipment in primary plant control.

Dynamic Graphical Pages

The graphical pages may consist of multiple dynamic graphical controls that show the current plant status in real time. It is also possible to access decentralized schedules, alarm servers, or trends. The graphical projects are designed with the L-VIS/L-WEB configuration tool free of charge. Without any know-how in HTML or Java, user specific graphical pages can be created. Dynamic information is shown through value or text controls, changing symbols, bar charts, trend views, alarm and event lists, or schedule controls. The L-VIS/L-WEB configuration tool allows for using most of the pixel graphic formats (GIF, JPG, BMP, TIFF, PNG, MNG, ICO), vector graphics (SVG) and alpha blending.

Playback of Audio Files and Streams

The L-VIS Touch Panel supports the playback of stereo MP3, WAV, and MP3 streams (for example webradio). The playback will be started or stopped by the respective action object. The action object is linked to one of the available audio files or to the URL of an MP3 stream. When accessing a playback via LWEB-802 or LWEB-803, it will be executed locally on the client.

Automatic Page Generation

Pages including data point names and values, alarm views, schedules, or trends can be created automatically by the L-VIS/L-WEB configuration tool. This significantly reduces engineering time and cost.



Connectivity and Data Points

The L-VIS Touch Panels support connectivity to LonMark Systems and BACnet networks. In addition, the Touch Panels provide communication to Modbus either as Master or Slave. For this purpose, Modbus TCP is supported exclusively and Modbus RTU is available via the RS-485 terminal.

L-VIS Touch Panels communicate with LonMark Systems via IP-852 (Ethernet/IP) or TP/FT-10 channels. The integrated remote network interface (Ethernet/IP) provides remote access to the TP/FT-10 channel for configuration, service and maintenance purposes.

BACnet networks are connected via BACnet/IP, BACnet/SC or BACnet MS/TP. The L-VIS Touch Panels implement the BACnet Building Controller (B-BC) profile and are BTL certified. They include a fully featured built-in BACnet/IP, BACnet/SC to MS/TP router with BBMD (BACnet Broadcast Management Device) and slave proxy functionality.

Math objects can calculate any kind of formula using data points available on the device.

L-VIS devices are equipped with two Ethernet ports. They can either be configured to use the internal switch to interconnect the two ports or every port is configured to work in a separate IP network.

When the Ethernet ports are configured for two separate IP networks, one port can be connected for instance to a WAN (Wide Area Network) with enabled network security (HTTPS) while the second port can be configured to be connected to an insecure network (LAN) where the standard building automation protocols like BACnet/IP, LON/IP, or Modbus TCP are used. These devices also feature firewall functionality to isolate particular protocols or services between the ports.

Using the internal switch, a daisy chained line topology of up to 20 devices can be built, which reduces costs for network installation. The IP switch also allows the setup of a redundant Ethernet installation (ring topology), which increases reliability. The redundant Ethernet topology is enabled by the Rapid Spanning Tree Protocol (RSTP), which is supported by most managed switches.

The L-VIS devices provide fully featured AST™ functionality (Alarming, Scheduling, and Trending) and can be integrated perfectly into the L-WEB Building Management System.

LVIS-3ME7-Gx/3ME12-A1/3ME15-A1/3ME15-Gx

Features

- High resolution TFT touch display with dimmable backlight
- Anodized aluminum front frame (LVIS-3ME12-A1, LVIS-3ME15-A1) or frameless glass front and capacitive touch (LVIS-3ME7-Gx, LVIS-3ME15-Gx)
- Flush-mounting in combination with the mounting frame
- Stores customized graphical pages
- Visualization of customized graphical pages through built-in touch panel, LWEB-900 (building management), and LWEB-802/803
- Device configuration and graphical page creation with the L-VIS/L-WEB configuration tool free of charge
- Supports all popular graphic file formats such as GIF, JPG, BMP, TIFF, PNG, MNG, ICO
- Support of SVG vector graphics
- Supports alpha blending
- Supports popular font types such as TrueType, Type-1, BDF, PCF, and OTF
- Supports Unicode text and complex writing systems
- Built-in OPC UA and OPC XML-DA server
- Built-in OPC XML-DA client
- Dual Ethernet/IP interface
- Alarming, Scheduling, and Trending (AST™)
- Node.js support for easy IoT integration (e.g. Google calendar, MQTT, Alexa & friends, multimedia equipment,...)
- Event-driven e-mail notification
- Math objects to execute mathematical operations on data points
- Compliant with CEA-709, CEA-852, and ISO/IEC 14908 Standard (LonMark System)
- Supports CEA-709 TP/FT-10 or IP-852 (Ethernet/IP)
- Support of dynamically created network variables or static network variables
- Support of user-defined NVs (UNVTs) and Configuration Properties (SCPTs, UCPTs)
- Remote Network Interface (RNI) with 2 MNI devices
- Compliant with ANSI/ASHRAE 135-2012 and ISO 16484-5:2012 standard
- Supports BACnet/IP, BACnet/SC and BACnet MS/TP
- BACnet Client Function (Write Property, Read Property, COV Subscription)
- BACnet Client Configuration with configuration tool (scan and EDE import)
- B-BC (BACnet Building Controller), BTL certified
- Integrated BACnet/IP, BACnet/SC to BACnet MS/TP Router
- BBMD (BACnet Broadcast Management Device)
- Modbus TCP and Modbus RTU (Master or Slave)
- Integrated web server for device configuration and monitoring data points
- Access to network statistics
- Configurable via Ethernet/IP or TP/FT-10
- Playback of audio files and streams
- Supports WLAN through LWLAN-800 Interface
- Supports LTE through LTE-800 Interface



LVIS-3ME7-Gx/3ME12-A1/3ME15-A1/3ME15-Gx

Specifications			
Type	LVIS-3ME7-Gx	LVIS-3ME12-A1	LVIS-3ME15-xx
Screen size	7" (178 mm)	12.1" (307 mm)	15" (381 mm)
Dimensions (mm)	223.5 x 162 x 65 (L x W x H), DIM004	329 x 268.3 x 65 (L x W x H), DIM002	394 x 318 x 65 (L x W x H), DIM003
Dimensions cut-out (mm)	195 x 143 x 61 (L x W x H)	300 x 250 x 61 (L x W x H)	355 x 295 x 61 (L x W x H)
Display resolution	800 x 480, 262 144 colors	800 x 600, 262 144 colors	1024x 768, 262 144 colors
Interfaces	2 x Ethernet (100Base-T), Switch, OPC UA (server) and OPC XML-DA (server, client), LonMark IP-852, BACnet/IP, BACnet/SC, Modbus TCP (Master or Slave), HTTP, FTP, SSH, HTTPS, SMTP, NTP, VNC 1 x TP/FT-10 1 x RS-485 (ANSI TIA/EIA-485): BACnet MS/TP or Modbus RTU/ASCII (Master or Slave) 2 x Digital Input 2 x USB-A: (LVIS-3ME15-Gx only 1 x USB-A) WLAN (needs LWLAN-800), LTE (needs LTE-800) 1 x USB-B (PC), speaker, audio output		
Remote Network Interface	1 RNI with 2 MNI devices		
Power supply	24 VDC \pm 10 %, 2.5 W, backlight on: 5 W	24 VDC \pm 10 %, 4 W, backlight on: 10 W or 85-240 V AC, 7 W, backlight on: 13 W	24 VDC \pm 10 %, 4 W, backlight on: 10 W or 85-240 V AC, 7 W, backlight on: 13 W
Operating conditions	+10 °C to 40 °C, 10-90 % RH, noncondensing		
Degree of protection	Front: IP54 / back: IP10		
Tools	L-VIS/L-WEB Configurator		
Resource limits			
OPC data points	10 000	BACnet calendar objects	25
Modbus data points	2 000	BACnet scheduler objects	200 (64 data points per object)
VNC clients	16	BACnet notification classes	32
Network variables (NVs)	1 000	E-mail templates	100
Alias NVs	1 000	Math objects	2 000
Address table entries	524 (non-ECS mode: 15)	Alarm logs	100
LonMark Calendars	1 (100 calendar patterns)	Trend logs	512 (4 000 000 entries, \approx 60 MB)
LonMark Schedulers	200	Total trended data points	512
LonMark Alarm Servers	1	Connections (Local/Global)	2 000/250
BACnet server objects	1 000	Number of L-WEB clients	32 (simultaneously)
Order number	Product description		
LVIS-3ME7-G1	CEA-709, BACnet, and Modbus Touch Panel 7", frameless glass front and capacitive touch, silver		
LVIS-3ME7-G2	CEA-709, BACnet, and Modbus Touch Panel 7", frameless glass front and capacitive touch, black		
LVIS-3ME12-A1	CEA-709, BACnet, and Modbus Touch Panel 12.1", aluminum frame with anodized finish		
LVIS-3ME15-A1	CEA-709, BACnet, and Modbus Touch Panel 15", aluminum frame with anodized finish		
LVIS-3ME15-G1	CEA-709, BACnet, and Modbus Touch Panel 15", frameless glass front and capacitive touch, silver		
LVIS-3ME15-G2	CEA-709, BACnet, and Modbus Touch Panel 15", frameless glass front and capacitive touch, black		
LVIS-3ME15-G3	CEA-709, BACnet, and Modbus Touch Panel 15", frameless glass front and capacitive touch, white		
LVIS-FRAME7	Mounting frame for 7" Touch Panels		
LVIS-FRAME12	Mounting frame for 12.1" Touch Panels		
LVIS-FRAME15	Mounting frame for 15" Touch Panels		
LVIS-ONWALL7	Wall mount frame side cover for LVIS-3ME7 (2 pieces), needs LVIS-FRAME7		
LVIS-ONWALL12	Wall mount frame side cover for LVIS-3ME12 (2 pieces), needs LVIS-FRAME12		
LVIS-ONWALL15	Wall mount frame side cover for LVIS-3ME15 (2 pieces), needs LVIS-FRAME15		
LVIS-MNTKIT-U	L-VIS Mounting Kit Universal (LVIS-FRAMEx not included)		
LWLAN-800	Wireless LAN Interface IEEE 802.11 bgn		
LTE-800	LTE Interface		

LSTAT-800, LSTAT-801, LSTAT-802

Datasheet #89034323



The L-STAT is a room operator panel device with a modern, minimalistic look that fits any interior design. It is directly connected to a LOYTEC controller with a Modbus interface such as a L-IOB I/O or L-ROC controller.

Up to 16 L-STAT devices can be connected to one controller to offer control at different locations in- or outside even for the largest rooms. The L-STAT is equipped with a segmented LCD display featuring an RGB backlight with adjustable color, offering a neat way to make the L-STAT match the interior color concept of an office building. Eight capacitive touch buttons are used to cycle through sensor values, display parameters, and adjust setpoints. Up to four external buttons can be accessed and processed by the controller.

The L-STAT's internal sensors measure temperature, humidity, dew point, occupancy, and CO₂ level. Sensor values can be displayed in SI or US units. Additionally, the date and time as well as the current level of eco-friendliness in the form of green leaves are also displayed on the LCD display. Parameters controlled by the controller's logic can be overridden on the L-STAT, such as for occupancy, air conditioning, and ventilation. A direct access mode is available to quickly adjust the most important setpoints e.g. for temperature and ventilation control.

A buzzer provides acoustic feedback for the touch buttons and can also be used to indicate alarms and error states. To prevent unauthorized modifications, two access levels (end user, system integrator) are used, which are secured via 4-digit pin codes. Device replacement, firmware upgrade, and L-STAT configuration are performed with very little effort through the controller. The L-STAT device is represented in the controller by a simple data point interface, which can be directly connected to the IEC 61131 or IEC 61499 logic application and offers all common functions for data points such as alarming, scheduling, trending, historic filters, math functions, etc.

Last but not least, the L-STAT comes with a built-in infrared receiver for comfortable remote control of the room's lights, sunblinds and HVAC system via the optionally available IR remote control L-RC1.

The L-STAT is available in three different hardware versions, with six different button layouts, and two front cover color options (36 models in total). Furthermore, Custom versions can also be ordered (minimum quantity 100 pieces).

In this case, custom printing on the front of the L-STAT allows for any button layout, individual button symbols and even catering the end customer's corporate identity.

L-STAT Custom Designs



L-STAT Room Operator Panel

LSTAT-800, LSTAT-801, LSTAT-802

Custom versions of the L-STAT are available with all three different hardware versions. Additionally, they can be equipped with an EnOcean interface. In this case, the L-STAT acts as a remote EnOcean transceiver for all controllers supporting an L-STAT interface.

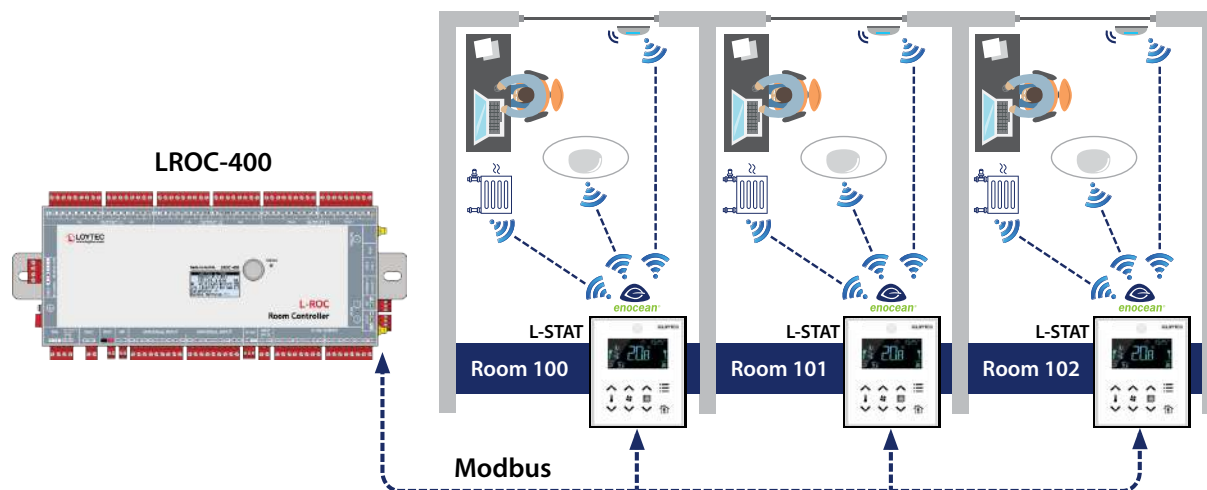

Features

- Modbus RTU interface for integration into controllers
- Easy integration into LOYTEC controllers such as L-INX, L-ROC or L-IOB I/O controller
- Segmented LCD display
- LCD RGB backlight color can be adjusted via network
- Display time and date
- Symbols for eco-friendliness level (green leaves)
- Up to 8 buttons (capacitive touch)
- Temperature sensor
- Humidity sensor
- 3 digital inputs (dry contact)
- 1 universal input (digital/NTC10k)
- Buzzer to provide acoustic feedback for the touch buttons or to indicate alarms
- Two access levels (end user, system integrator), which are secured via 4-digit pin codes
- Enclosure color options black and white
- Individual layout of touch symbols on request to match room functions
- Individual front cover printing on request to match clients room design or corporate identity
- Optional occupancy sensor (LSTAT-801 and LSTAT-802 models only)
- Optional CO₂ sensor (LSTAT-802 models only)
- Optional EnOcean interface (custom models only) to work as remote EnOcean transceiver for LOYTEC controllers

LSTAT-800, LSTAT-801, LSTAT-802

Specifications

Type	LSTAT-800-Gx-Lxxx	LSTAT-801-Gx-Lxxx	LSTAT-802-Gx-Lxxx
Dimensions (mm)	94.5 x 110 x 19.5 (L x W x H), DIM032		
Installation	Onto a flush-mounted box		
Power supply	24 VDC \pm 10 %, max. 0.8 W		24 VDC \pm 10 %, max. 1.8 W
Operating conditions	0 °C to 50 °C, 10 – 90 % RH, noncondensing, degree of protection: IP30		
Display	LCD display featuring an RGB backlight with adjustable color		
Interfaces, sensors	1 x RS-485 (ANSI TIA/EIA-485): Modbus RTU (Master or Slave), adjustable bus speed 1 200 – 115 200 bit/s (default 57 600 bit/s), configurable transmission mode (default "8N2", 1 start bit, 8 data bits, parity none, 2 stop bits) 1 x Buzzer 1 x Internal temperature sensor 1 x Internal relative humidity sensor 3 x Digital Input for connection of standard switches and pushbuttons 1 x Universal Input, configurable either for L-TEMP2 (NTC temperature sensor) or for connection of standard switches and pushbuttons 1 x Infrared receiver 1 x EnOcean Wireless Interface conforming to ISO/IEC 14543-3-10 (optional for L-STAT custom versions)		
		1 x Occupancy sensor	
			1 x CO ₂ sensor
Buttons (capacitive touch)	LSTAT-80x-Gx-Lxx1: 4 x Button with temperature up/down, occupancy, and menu LSTAT-80x-Gx-Lxx2: 6 x Button with temperature up/down, fan up/down, occupancy, and menu LSTAT-80x-Gx-Lxx3: 8 x Button with temperature up/down, fan up/down, light on/off, occupancy, and menu LSTAT-80x-Gx-Lxx4: 8 x Button with temperature up/down, sunblinds up/down, light on/off, occupancy, and menu LSTAT-80x-Gx-Lxx5: 8 x Button with temperature up/down, fan up/down, sunblinds up/down, occupancy, and menu LSTAT-80x-Gx-Lxx6: 8 x Button with temperature up/down, fan up/down, sunblinds up/down, light, and menu		

Specifications of the sensors

Temperature measurement	Sensor type: CMOS, range: -40 – 125 °C, resolution: 0.1 °C, accuracy: \pm 0.5 °C (5 – 60 °C)
Relative Humidity (R.H.)	Sensor type: capacitive humidity sensor, range: 0% – 100% R.H., resolution: 0.1% R.H., accuracy: \pm 2% R.H. @ 25 °C, 20% – 80% R.H. \pm 3% R.H. @ 25 °C, 0% – 20% R.H. and 80% – 100% R.H., respectively
Infrared occupancy detector, maximum detection range	5 m, 64 zones, opening angle horizontal: 94°, vertical: 82°, difference in temperature: target to environment: > 4 °C
CO ₂	0 – 2 000 ppm, \pm 30 ppm or \pm 3%
Infrared receiver	NEC protocol (Apple Remote compatible)

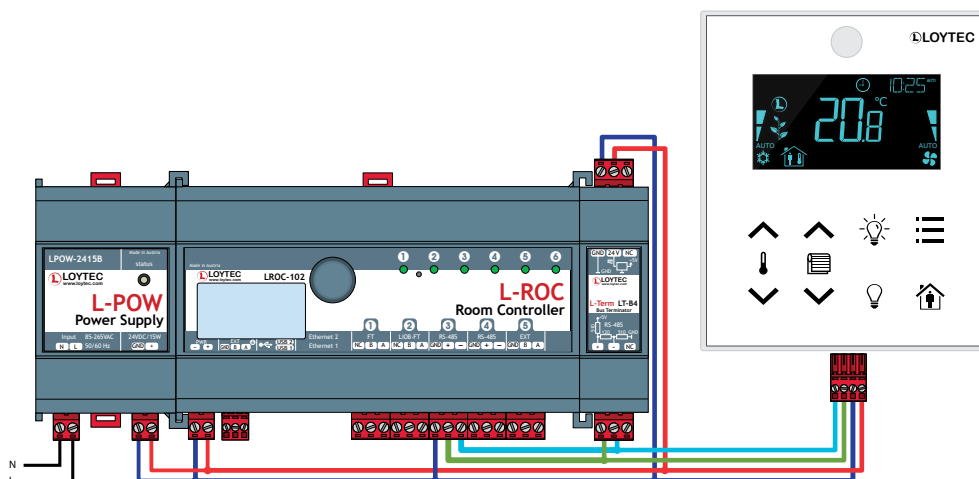

L-STAT Room Operator Panel

LSTAT-800, LSTAT-801, LSTAT-802

L-STAT Button Configuration Overview

L-STAT-80x-G3-L1

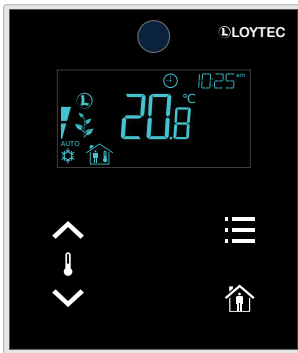

L-STAT-80x-G3-L2



L-STAT-80x-G3-L3



L-STAT-80x-G3-L4



L-STAT-80x-G3-L5



L-STAT-80x-G3-L6

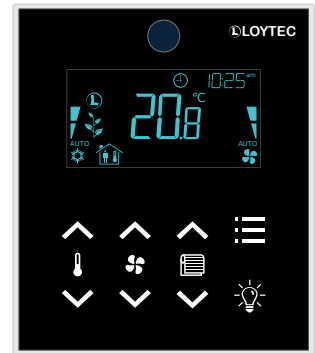

L-STAT-80x-G3-L201

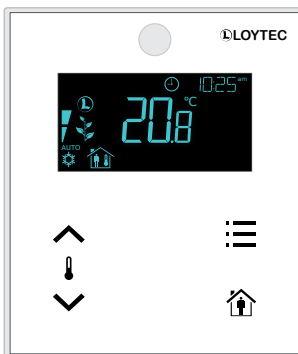

L-STAT-80x-G3-L202

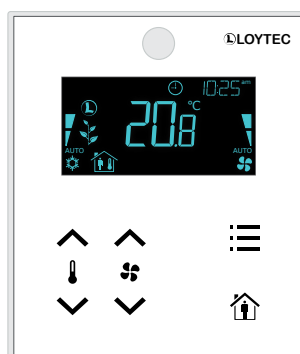

L-STAT-80x-G3-L203

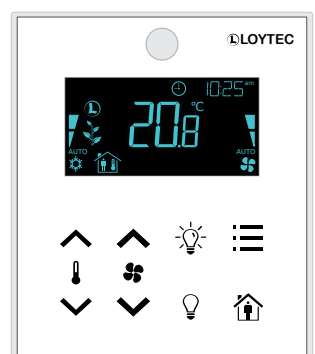

L-STAT-80x-G3-L204

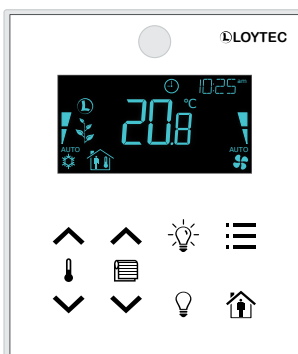

L-STAT-80x-G3-L205

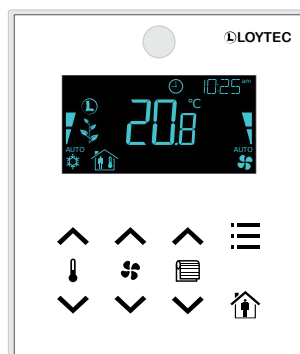

L-STAT-80x-G3-L206

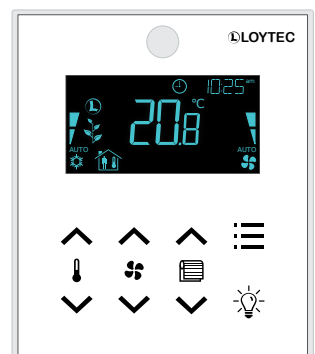

LSTAT-800, LSTAT-801, LSTAT-802

Order number	Product description
LSTAT-800-G3-L1	Room Operator Panel, black front, white enclosure, Modbus, temperature, rel. humidity, ext. switch/NTC, IR receiver, Buttons (L1): temperature up_down/occupancy/menu
LSTAT-800-G3-L2	Room Operator Panel, black front, white enclosure, Modbus, temperature, rel. humidity, ext. switch/NTC, IR receiver, Buttons (L2): temperature up_down/fan up_down/occupancy/menu
LSTAT-800-G3-L3	Room Operator Panel, black front, white enclosure, Modbus, temperature, rel. humidity, ext. switch/NTC, IR receiver, Buttons (L3): temperature up_down/fan up_down/light on_off/occupancy/menu
LSTAT-800-G3-L4	Room Operator Panel, black front, white enclosure, Modbus, temperature, rel. humidity, ext. switch/NTC, IR receiver, Buttons (L4): temperature up_down/sunblinds up_down/light on_off/occupancy/menu
LSTAT-800-G3-L5	Room Operator Panel, black front, white enclosure, Modbus, temperature, rel. humidity, ext. switch/NTC, IR receiver, Buttons (L5): temperature up_down/fan up_down/sunblinds up_down/occupancy/menu
LSTAT-800-G3-L6	Room Operator Panel, black front, white enclosure, Modbus, temperature, rel. humidity, ext. switch/NTC, IR receiver, Buttons (L6): temperature up_down/fan up_down/sunblinds up_down/light/menu
LSTAT-801-G3-L1	Room Operator Panel, front black, white enclosure, Modbus, temperature, rel. humidity, ext. switch/NTC, occupancy, IR receiver, Buttons (L1): temperature up_down/occupancy/menu
LSTAT-801-G3-L2	Room Operator Panel, front black, white enclosure, Modbus, temperature, rel. humidity, ext. switch/NTC, occupancy, IR receiver, Buttons (L2): temperature up_down/fan up_down/occupancy/menu
LSTAT-801-G3-L3	Room Operator Panel, front black, white enclosure, Modbus, temperature, rel. humidity, ext. switch/NTC, occupancy, IR receiver, Buttons (L3): temperature up_down/fan up_down/light on_off/occupancy/menu
LSTAT-801-G3-L4	Room Operator Panel, front black, white enclosure, Modbus, temperature, rel. humidity, ext. switch/NTC, occupancy, IR receiver, Buttons (L4): temperature up_down/sunblinds up_down/light on_off/occupancy/menu
LSTAT-801-G3-L5	Room Operator Panel, front black, white enclosure, Modbus, temperature, rel. humidity, ext. switch/NTC, occupancy, IR receiver, Buttons (L5): temperature up_down/fan up_down/sunblinds up_down/occupancy/menu
LSTAT-801-G3-L6	Room Operator Panel, front black, white enclosure, Modbus, temperature, rel. humidity, ext. switch/NTC, occupancy, IR receiver, Buttons (L6): temperature up_down/fan up_down/sunblinds up_down/light/menu
LSTAT-802-G3-L1	Room Operator Panel, front black, white enclosure, Modbus, temperature, rel. humidity, ext. switch/NTC, occupancy, IR receiver, CO2, Buttons (L1): temperature up_down/occupancy/menu
LSTAT-802-G3-L2	Room Operator Panel, front black, white enclosure, Modbus, temperature, rel. humidity, ext. switch/NTC, occupancy, IR receiver, CO2, Buttons (L2): temperature up_down/fan up_down/occupancy/menu
LSTAT-802-G3-L3	Room Operator Panel, front black, white enclosure, Modbus, temperature, rel. humidity, ext. switch/NTC, occupancy, IR receiver, CO2, Buttons (L3): temperature up_down/fan up_down/light on_off/occupancy/menu
LSTAT-802-G3-L4	Room Operator Panel, front black, white enclosure, Modbus, temperature, rel. humidity, ext. switch/NTC, occupancy, IR receiver, CO2, Buttons (L4): temperature up_down/sunblinds up_down/light on_off/occupancy/menu
LSTAT-802-G3-L5	Room Operator Panel, front black, white enclosure, Modbus, temperature, rel. humidity, ext. switch/NTC, occupancy, IR receiver, CO2, Buttons (L5): temperature up_down/fan up_down/sunblinds up_down/occupancy/menu
LSTAT-802-G3-L6	Room Operator Panel, front black, white enclosure, Modbus, temperature, rel. humidity, ext. switch/NTC, occupancy, IR receiver, CO2, Buttons (L6): temperature up_down/fan up_down/sunblinds up_down/light/menu
L-RC1	Infrared remote control for room automation applications

A complete list of L-STAT models is available on our website www.loytec.com/lstat.

L-STAT Custom Designs

LSTAT-80x-CUSTOM	One-time customization cost for L-STAT custom design, including 2 working samples
LSTAT-800-GX-LX-CU	LSTAT-800 based custom design, Room Operator Panel, minimum quantity 100 pieces, enclosure G1: silver, G2: black, G3: white; custom print Lx, including 2 working samples, typical lead time 10 weeks
LSTAT-801-GX-LX-CU	LSTAT-801 based custom design, Room Operator Panel, minimum quantity 100 pieces, enclosure G1: silver, G2: black, G3: white; custom print Lx, including 2 working samples, typical lead time 10 weeks
LSTAT-802-GX-LX-CU	LSTAT-802 based custom design, Room Operator Panel, minimum quantity 100 pieces, enclosure G1: silver, G2: black, G3: white; custom print Lx, including 2 working samples, typical lead time 10 weeks
LSTAT-810-GX-LX-CU	LSTAT-800 based custom design, Room Operator Panel, minimum quantity 100 pieces, EnOcean optional, enclosure G1: silver, G2: black, G3: white; custom print Lx, including 2 working samples, typical lead time 10 weeks
LSTAT-812-GX-LX-CU	LSTAT-802 based custom design, Room Operator Panel, minimum quantity 100 pieces, EnOcean optional, enclosure G1: silver, G2: black, G3: white; custom print Lx, including 2 working samples, typical lead time 10 weeks

L-STAT Room Operator Panel

LSTAT-800, LSTAT-801, LSTAT-802

Order number	Product description
LSTAT-800-G3-L201	Room Operator Panel, white front, white enclosure, Modbus, temperature, rel. humidity, ext. switch/NTC, IR receiver, Buttons (L1): temperature up_down/occupancy/menu
LSTAT-800-G3-L202	Room Operator Panel, white front, white enclosure, Modbus, temperature, rel. humidity, ext. switch/NTC, IR receiver, Buttons (L2): temperature up_down/fan up_down/occupancy/menu
LSTAT-800-G3-L203	Room Operator Panel, white front, white enclosure, Modbus, temperature, rel. humidity, ext. switch/NTC, IR receiver, Buttons (L3): temperature up_down/fan up_down/light on_off/occupancy/menu
LSTAT-800-G3-L204	Room Operator Panel, white front, white enclosure, Modbus, temperature, rel. humidity, ext. switch/NTC, IR receiver, Buttons (L4): temperature up_down/sunblinds up_down/light on_off/occupancy/menu
LSTAT-800-G3-L205	Room Operator Panel, white front, white enclosure, Modbus, temperature, rel. humidity, ext. switch/NTC, IR receiver, Buttons (L5): temperature up_down/fan up_down/sunblinds up_down/occupancy/menu
LSTAT-800-G3-L206	Room Operator Panel, white front, white enclosure, Modbus, temperature, rel. humidity, ext. switch/NTC, IR receiver, Buttons (L6): temperature up_down/fan up_down/sunblinds up_down/light/menu
LSTAT-801-G3-L201	Room Operator Panel, white front, white enclosure, Modbus, temperature, rel. humidity, ext. switch/NTC, occupancy, IR receiver, Buttons (L1): temperature up_down/occupancy/menu
LSTAT-801-G3-L202	Room Operator Panel, white front, white enclosure, Modbus, temperature, rel. humidity, ext. switch/NTC, occupancy, IR receiver, Buttons (L2): temperature up_down/fan up_down/occupancy/menu
LSTAT-801-G3-L203	Room Operator Panel, white front, white enclosure, Modbus, temperature, rel. humidity, ext. switch/NTC, occupancy, IR receiver, Buttons (L3): temperature up_down/fan up_down/light on_off/occupancy/menu
LSTAT-801-G3-L204	Room Operator Panel, white front, white enclosure, Modbus, temperature, rel. humidity, ext. switch/NTC, occupancy, IR receiver, Buttons (L4): temperature up_down/sunblinds up_down/light on_off/occupancy/menu
LSTAT-801-G3-L205	Room Operator Panel, white front, white enclosure, Modbus, temperature, rel. humidity, ext. switch/NTC, occupancy, IR receiver, Buttons (L5): temperature up_down/fan up_down/sunblinds up_down/occupancy/menu
LSTAT-801-G3-L206	Room Operator Panel, white front, white enclosure, Modbus, temperature, rel. humidity, ext. switch/NTC, occupancy, IR receiver, Buttons (L6): temperature up_down/fan up_down/sunblinds up_down/light/menu
LSTAT-802-G3-L201	Room Operator Panel, white front, white enclosure, Modbus, temperature, rel. humidity, ext. switch/NTC, occupancy, IR receiver, CO2, Buttons (L1): temperature up_down/occupancy/menu
LSTAT-802-G3-L202	Room Operator Panel, white front, white enclosure, Modbus, temperature, rel. humidity, ext. switch/NTC, occupancy, IR receiver, CO2, Buttons (L2): temperature up_down/fan up_down/occupancy/menu
LSTAT-802-G3-L203	Room Operator Panel, white front, white enclosure, Modbus, temperature, rel. humidity, ext. switch/NTC, occupancy, IR receiver, CO2, Buttons (L3): temperature up_down/fan up_down/light on_off/occupancy/menu
LSTAT-802-G3-L204	Room Operator Panel, white front, white enclosure, Modbus, temperature, rel. humidity, ext. switch/NTC, occupancy, IR receiver, CO2, Buttons (L4): temperature up_down/sunblinds up_down/light on_off/occupancy/menu
LSTAT-802-G3-L205	Room Operator Panel, white front, white enclosure, Modbus, temperature, rel. humidity, ext. switch/NTC, occupancy, IR receiver, CO2, Buttons (L5): temperature up_down/fan up_down/sunblinds up_down/occupancy/menu
LSTAT-802-G3-L206	Room Operator Panel, white front, white enclosure, Modbus, temperature, rel. humidity, ext. switch/NTC, occupancy, IR receiver, CO2, Buttons (L6): temperature up_down/fan up_down/sunblinds up_down/light/menu
L-RC1	Infrared remote control for room automation applications

A complete list of L-STAT models is available on our website www.loytec.com/lstat.

LSTAT-810-G3-L0, LSTAT-820-G3-L0, LSTAT-830-G3-L0

Datasheet #89077722



The L-STAT Remote EnOcean Antenna integrates wireless EnOcean sensors and devices seamlessly into building automation. The L-STAT Remote EnOcean Antenna only needs to be connected to the Modbus port.

The L-STAT Remote EnOcean Antenna is available in three different versions for worldwide use:

- LSTAT-810-G3-L0 Europe 868 MHz band
- LSTAT-820-G3-L0 USA/Canada 902 MHz band
- LSTAT-830-G3-L0 Japan 928 MHz band

In addition to the remote antenna capability, it also features a temperature and humidity sensor.

Features

- Supports all common EnOcean Profiles (EEPs) for sensors and actuators
- Configurable through device templates within the L-INX Configurator software
- Web interface for teach-in, signal strength, and value test through LOYTEC controller
- Easy device replacement
- Connected via Modbus RTU
- Support of multi-channel EnOcean devices
- Encrypted wireless connection if the EnOcean device supports this function
- Supports Mailbox function for sleepy actuators (e.g., battery-powered radiator valve)
- Up to 16 L-STAT Remote EnOcean Antennas per LOYTEC controller
- EnOcean Alliance certified

Specifications

Type	LSTAT-810-G3-L0	LSTAT-820-G3-L0	LSTAT-830-G3-L0
Dimensions (mm)	94.5 x 110 x 19.5 (L x W x H), DIM067		
Installation	Onto a flush-mounted box		
Power supply	24 VDC \pm 10 %, max. 0.4 W		
Operating conditions	0 °C to 50 °C, 10 – 90 % RH, noncondensing, degree of protection: IP30		
Interfaces	1 x RS-485 (ANSI TIA/EIA-485): Modbus RTU (Slave), bus speed 57 600 bit/s, address range 1-16 1 x EnOcean Wireless Interface conforming to ISO/IEC 14543-3-10		
Temperature measurement	Sensor type: CMOS, range: -40 – 125 °C, resolution: 0.1 °C, accuracy: \pm 0.5 °C (5 – 60 °C)		
Relative Humidity (R.H.)	Sensor type: capacitive humidity sensor, range: 0 % – 100 % R.H., resolution: 0.1 % R.H., accuracy: \pm 2 % R.H. @ 25 °C, 20 % – 80 % R.H. \pm 3 % R.H. @ 25 °C, 0 % – 20 % R.H. and 80 % – 100 % R.H., respectively		
Frequency	868.3 MHz	902.875 MHz	928.35 MHz
RF output power	3 dBm	1 dBm	0 dBm
EnOcean data rate	125 kbit/s		
Tools	L-INX Configurator		
Number of L-STAT antennas per LOYTEC controller (maximum)	16		
Number of EnOcean devices per L-STAT antenna (maximum)	30 (20 SmartAck)		
EnOcean Alliance certification	EnOcean Alliance certified	EnOcean Alliance certified	EnOcean Alliance certified

Order number

Product description

LSTAT-810-G3-L0	Remote EnOcean Antenna, Europe, White
LSTAT-820-G3-L0	Remote EnOcean Antenna, USA/CA, White
LSTAT-830-G3-L0	Remote EnOcean Antenna, Japan, White

L-DALI Lighting Control



L-DALI Lighting Control

L-DALI Overview

The L-DALI product line offers the combination of DALI lighting controls functionality that leaves nothing to be desired with a powerful lighting application. It allows to incorporate the lighting system in the higher-level building automation system and an integration in the remaining automation system to realize a fully integrated room automation solution.

L-DALI controllers are multifunctional devices featuring DALI light control and gateway functionality between DALI (Digital Addressable Lighting Interface) and LonMark Systems, BACnet or Modbus Networks. Besides the integration of DALI ballasts they likewise support DALI-2 buttons e.g. LDALI-BM2 and also a variety of DALI-2 multi sensors like the LDALI-MS2. With the LDALI-RM5/RM6/RM8 Relay Module, standard loads in the power grid can be controlled via DALI. EnOcean push buttons and multi-sensors can be integrated using the optional L-ENO extension modules. With the LSMI-804 extension module SMI sunblinds on up to four SMI channels can be integrated in the lighting application.

The built-in web server allows for device configuration, DALI system configuration and maintenance. L-DALI controllers feature alarming, scheduling, trending (AST™) and e-mail notification functionality.

Additional features include data exchange via global connections (network-wide data exchange), a built-in DALI bus power supply, and a 128x64 graphical display for manual operation using a jog dial.

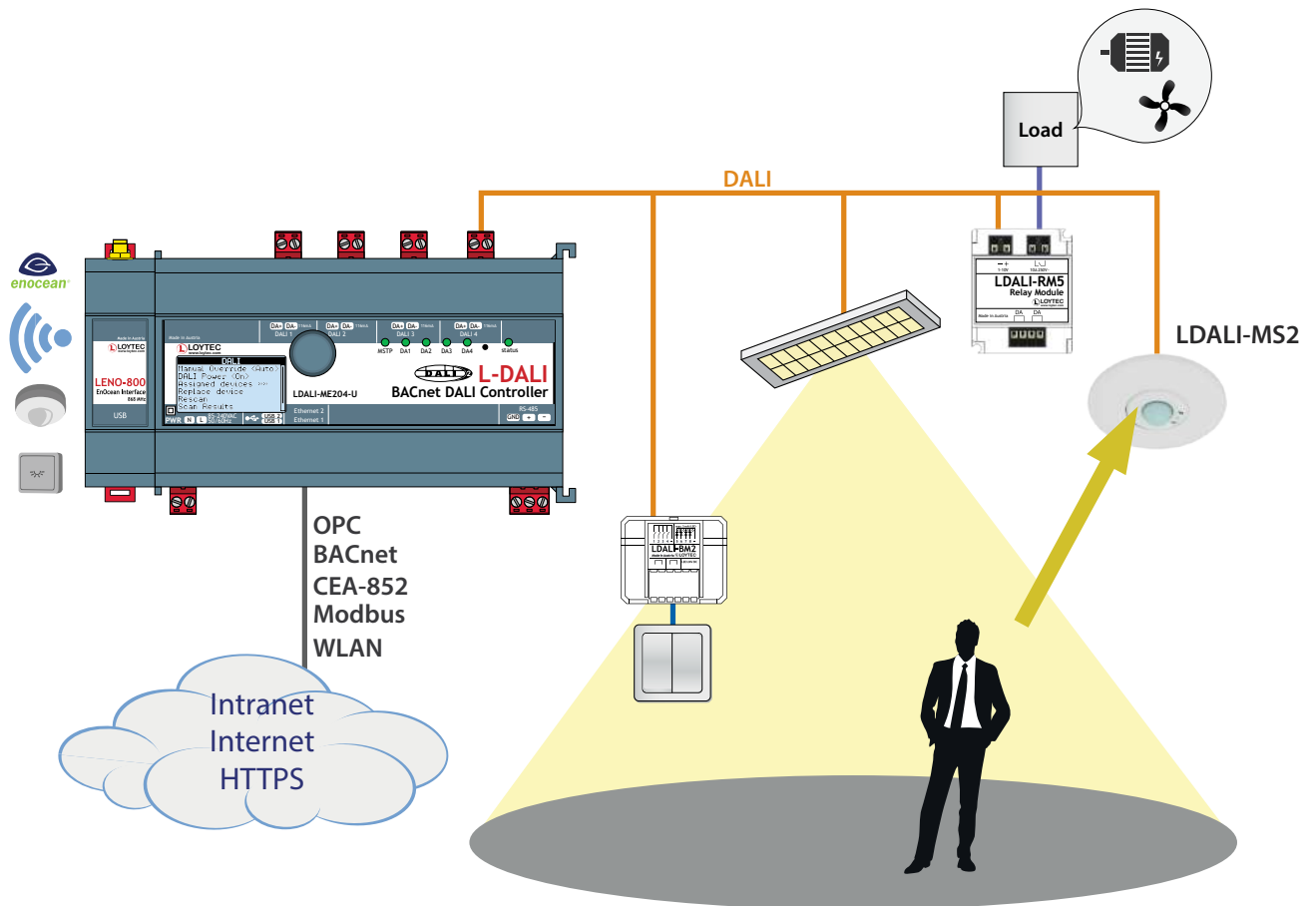

LDALI-3E101-U, LDALI-3E102-U, LDALI-3E104-U

Datasheet #89016924

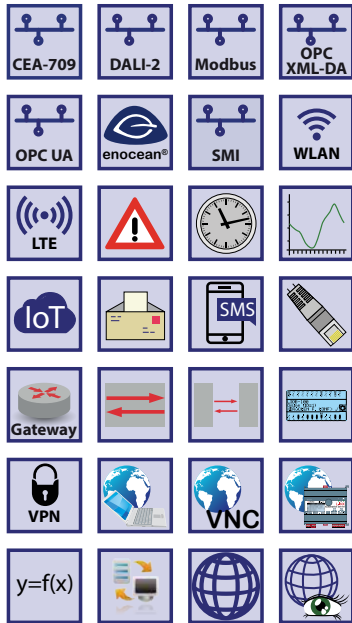

L-DALI Controllers are multifunctional devices combining constant light control, sunblind control, and gateway functions between LonMark and DALI (Digital Addressable Lighting Interface) systems. With Alarming, Scheduling, Trending, and e-mail notification (AST™) the L-DALI Controller is a perfect solution for DALI lighting systems and for a smooth DALI integration into LonMark Systems.

DALI Network Interface

L-DALI Controllers act as a DALI-Master in the DALI network and can interact with DALI-2 multi-sensors and buttons in Multi-Master mode. The L-DALI lineup for LonMark Systems features 1, 2, or 4 independent DALI channels. Up to 64 DALI or DALI-2 based luminaires per DALI channel can be controlled individually or via 16 groups. All luminaires are monitored for lamp or ballast defect. In addition up to 64 DALI-2 input devices are supported per DALI channel. Each input device can be equipped with push buttons, sliders, occupancy and light sensors.

Built-In DALI Bus Power Supply

All L-DALI models come with a built-in DALI bus power supply. The LDALI-3E101-U and the LDALI-3E102-U can supply each DALI channel with a guaranteed supply current of 230 mA, the LDALI-3E104-U can supply 116 mA per channel. In case of the LDALI-3E104-U an external DALI bus power supply can be added to top up the supply current to 232 mA. External power supplies are available for up to four DALI channels. The internal DALI bus power can be switched on and off via web interface or LCD UI. Thanks to the switching power supply, these devices can handle input voltages from 85 – 240 V AC, 50/ 60 Hz.

LonMark TP/FT-10 or Ethernet/IP-852 Connection

The L-DALI Controllers provide connectivity in LonMark Systems through IP-852, or TP/FT-10 as well as data exchange through Global Connections. They support comprehensive AST™ functionality (Alarming, Scheduling, and Trending) with e-mail notification. Full L-WEB integration is supported as well. The L-DALI Controllers are equipped with two Ethernet ports including a built-in Ethernet switch.

IoT Integration

The IoT function (Node.js) allows connecting the system to almost any cloud service, either for uploading historical data to analytics services, telemetry using MQTT, delivering alarm messages to alarm processing services or operating parts of the control system over a cloud service (e.g., scheduling based on Web calendars or booking systems). Processing Internet information such as weather data in forecast-based control is also possible. Finally, the JavaScript kernel also allows implementing serial protocols to non-standard equipment in primary plant control.

Local Operation and Override

The L-DALI Controllers come with a built-in backlit display (128x64) and a jog dial for local operation and override. Using the local operation, maintenance tasks (DALI device replacement, burn-in mode, etc.) can be executed without the need of any software tool.

Constant Light Control

The integrated Constant Light Controller (LonMark Functional Profile #3050) allows controlling local DALI ballasts and luminaires via the CEA-709 network. It supports various lighting control strategies, presence and lux level based. Several parameters can be used to configure the Constant Light Controller for almost any use case.

Sunblind Control with Constant Light Control Interaction

The integrated Sunblind Controller (LonMark Functional Profile #6111) allows intelligent controlling of blinds connected via SMI (requires LSMI-804) or the

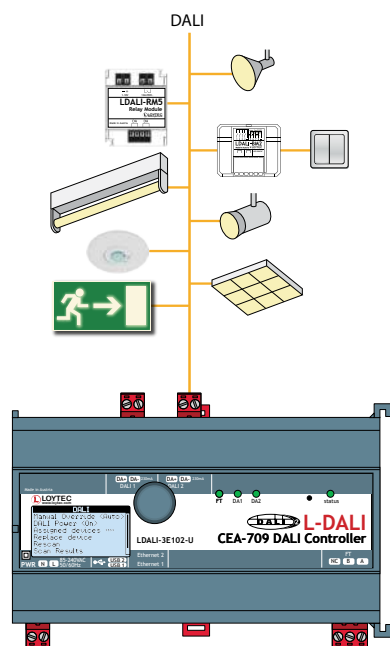

CEA-709 network. It offers effective sun and anti-glare protection through active slat control and slat adjustment according to the sun position. Energy efficiency is ensured by linking room occupancy with sun protection. If a room is unoccupied, the L-DALI Controller opens or closes the sunblinds depending on the thermal requirements. This allows for instance to use the heat of the sun for heating in winter while in summer, the heat from the sun is reduced by the closed blinds to reduce the cooling load.

Optionally, the sunblind and light control applications of a room or an area can be linked together. As both applications control the light available in the room this holistic approach assures maximum comfort and energy efficiency.

In addition to the constant light and sunblind control, any mathematical calculation and function or logical operation (Boolean algebra) can be created on the device and process all available data points.

Device Configuration via Tool or Web Interface

The device configuration, commissioning, and parameterization is done either with the configuration tool software (used as stand-alone tool or as LNS® plug-in) or via the integrated web server.

EnOcean, OPC and Modbus

Wireless EnOcean sensors and buttons can be integrated via the optional L-ENO EnOcean interface. To use the L-DALI with an existing SCADA solution all run-time values and parameters can be accessed via OPC (XML/DA and UA) and Modbus TCP.

Advanced DALI Functions

- **DALI Sensors**

The L-DALI Controllers support the integration of DALI-2 multi-sensors for presence detection and light level recognition. In addition to the LOYTEC multi-sensors LDALI-MS2-BT/MS3-BT/MS4-BT, DALI-2 sensors of many well-known manufacturers can be used. For asset tracking in office buildings with the LOYTEC multi-sensors (LDALI-MSx-BT), a LIC-ASSET license is required.

- **DALI Buttons**

For manual operation, DALI-2 push button couplers, like the LDALI-BM2, DALI-2 operation panels, and IR remote controls can be integrated into the system. Their functionality can be configured individually. In addition to controlling lighting via DALI (dimming, scene recall, etc.) and sunblinds via SMI (up, down, etc.), button press events can be propagated in the building network, triggering other, non-lighting related building automation functions. Support of feedback feature for pushbutton instances according to IEC 62386-332 is provided.

- **DALI Relay Modules**

Standard loads in the power grid can be controlled via DALI using DALI relay modules, like the LDALI-RM5, LDALI-RM6 and LDALI-RM8.

- **DALI Color Control**

The L-DALI allows controlling DALI luminaires with colour control functionality (DT8). Both, tunable white (Tc) and full RGB color control (RGBWAF and xy-coordinate) are supported. Light color can either be changed automatically, via manual operation (e.g. buttons) or via the network.

- **Auto Burn-In for fluorescent Lamps**

Fluorescent lamps must be operated about 100 hours with 100 % brightness before they may be dimmed. This burn-in process is monitored by L-DALI for each lamp. After 100 hours burn-in time, the lamp's constant light control is enabled.

LDALI-3E101-U, LDALI-3E102-U, LDALI-3E104-U

• Automatic Test of Emergency Lighting Systems

In DALI emergency lighting systems based on IEC 62386-202, L-DALI can be used for testing the system. The results can be logged.

• Collection of important Operational Parameters

For maximum transparency in the lighting system, L-DALI can record the operating hours of each lamp and also the energy consumption (calculated).

• DALI Device Replacement made easy

Defective DALI ballasts can easily be replaced directly on the L-DALI Controller (LCD and jog dial) or via the web interface. No software tool is necessary.

LonMark Interface

The L-DALI Controller maps information from the DALI network to Network Variables (NVs) to control DALI ballasts or display operating states including DALI sensor occupancy and lux level information. L-DALI Controller for LonMark Systems can be connected either to an Ethernet/IP channel (LonMark IP-852) or a TP/ FT 10 channel. The provided static NV interface includes the following profiles:

- Lamp Actuator #3040
- Constant Light Controller #3050
- Light Sensor #1010
- Sunblind Controller #6111
- Occupancy Sensor #1060
- Open Loop Sensor (button) #1

All data points are available in a tree structure on the integrated web server to be displayed or set using a web browser.

Features

- DALI integration into LonMark Systems
- Supports up to 64 DALI ballasts and 16 DALI groups per DALI channel
- Supports up to 64 input devices overall per channel
- Up to 16 DALI sensors per DALI channel are supported
- Up to 64 DALI button modules per DALI channel are supported
- Integrated DALI bus power supply
- Manual operation using the jog dial and local access to information about device status and data points in clear text and symbols
- 128x64 graphic display with backlight
- Built-in web server for device configuration
- Test and assignment of DALI devices via the web interface
- Replacement of DALI devices without additional software tools via LCD and jog dial
- Supports the control of standard loads in the power grid via LDALI-RM5/RM6/RM8 Relay Modules
- Integrated Constant Light Controller
- Integrated Sunblind Controller
- Supports DALI-2 devices (drivers and input devices)
- DALI-2 certified (compliant with IEC 62386-101 and IEC 62386-103)
- Support DALI color control (DT8 tunable white & full color control)
- Supports lamp burn-in mode
- Supports periodic testing of DALI emergency lights
- Integrated DALI Protocol Analyzer
- Compliant with CEA-709, CEA-852 and ISO/IEC 14908-1 standard (LonMark System)
- Network connection either with TP/FT-10 or IP-852 (CEA-852 Ethernet)
- Alarming, Scheduling, and Trending (AST™) locally or embedded in L-WEB (building management)
- Node.js support for easy IoT integration (e.g. Google calendar, MQTT, Alexa & friends, multimedia equipment,...)
- Event-driven e-mail notification
- Supports Local and Global Connections
- Stores customized graphical pages
- Visualization of customized graphical pages through LWEB-900 (Building Management), LWEB-803 (Monitoring and Control), or LWEB-802 (Web Browser)
- Stores user-defined project documentation
- Dual Ethernet/IP interface
- Built-in OPC XML-DA and OPC UA server
- Modbus TCP (Master or Slave)
- Supports SMI (Standard Motor Interface) through LSMI-804
- Connection to EnOcean wireless devices via LENO-80x Interface
- Supports WLAN through LWLAN-800 Interface
- Supports LTE through LTE-800 Interface
- Supports RS-232 through LRS232-802 Interface
- Configurable Bluetooth beacons and services: indoor navigation, asset tracking (requires LIC-ASSET license) and access to LWEB-900 room control solution

CEA-709/DALI Controller

LDALI-3E101-U, LDALI-3E102-U, LDALI-3E104-U

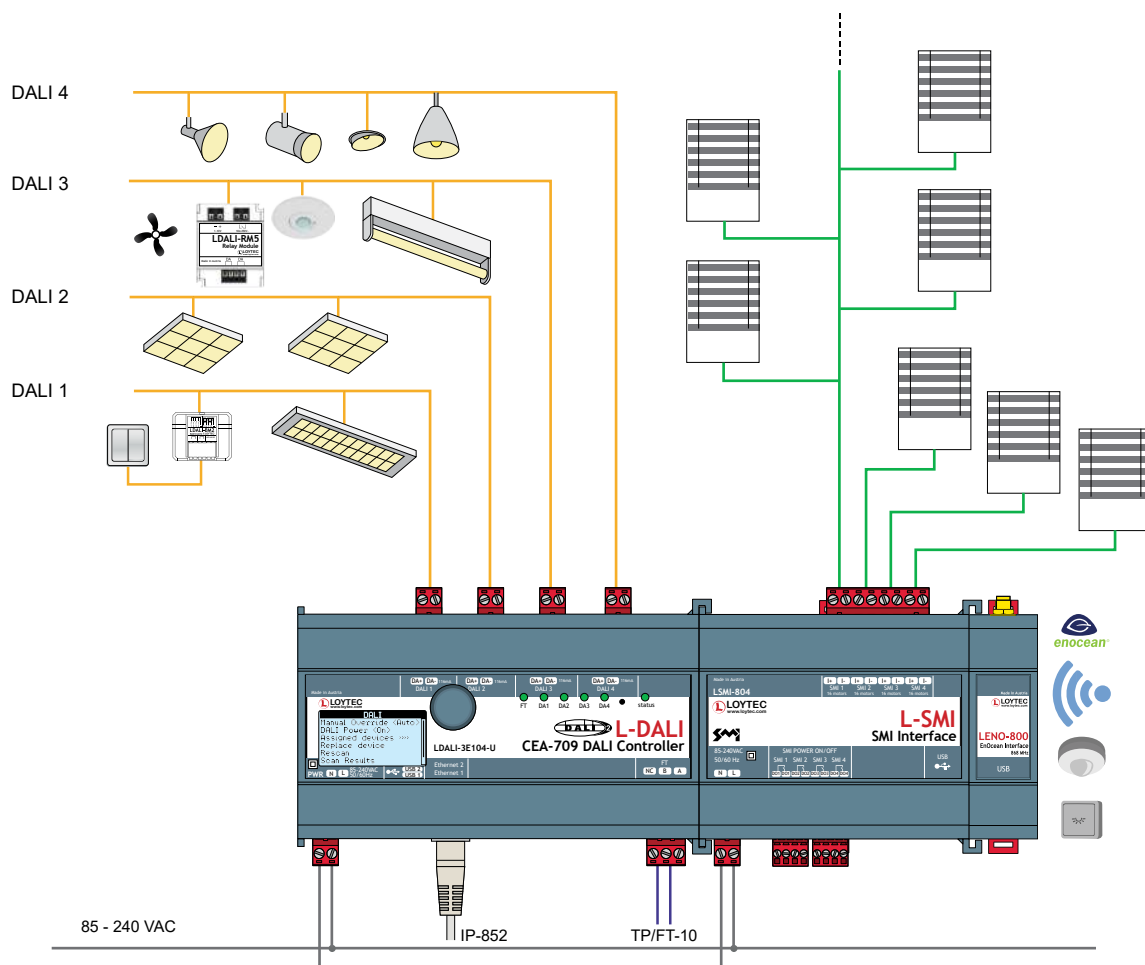

Specifications			
Type	LDALI-3E101-U	LDALI-3E102-U	LDALI-3E104-U
Dimensions (mm)	159 x 100 x 75 (L x W x H), DIM035		
Installation	DIN rail mounting following DIN 43880, top hat rail EN 50022		
Power supply	85-240 V AC, 50/60 Hz, typ. 9 W (4 W + 5 W DALI)	85-240 V AC, 50/60 Hz, typ. 14 W (4 W + 2 x 5 W DALI)	85-240 V AC, 50/60 Hz, typ. 14 W (4 W + 4 x 2.5 W DALI)
Operating conditions	0 °C to 40 °C, 10 – 90 % RH, noncondensing, degree of protection: IP40, IP20 (terminals)		
DALI channels	1	2	4
Integrated DALI bus power supply (per channel)	16 VDC 230 mA guaranteed supply current*** 250 mA max. supply current		16 VDC 116 mA guaranteed supply current*** 125 mA max. supply current
Interfaces	2 x Ethernet (100Base-T): OPC XML-DA, OPC UA, LonMark IP-852*, Modbus TCP, HTTP, FTP, SSH, HTTPS, Firewall, VNC, SNMP 1 x TP/FT-10* (LonMark system) 2 x USB-A: WLAN (needs LWLAN-800), EnOcean (needs LENO-80x), SMI (needs LSMI-804), LTE (needs LTE-800) * Either LonMark IP-852 or TP/FT-10		
LonMark Profile	Lamp Actuator #3040, Light Sensor #1010, Occupancy Sensor #1060, Constant Light Controller #3050, Sunblind Controller #6111 Open loop sensor (button) #1		
Tools	L-INX Configurator, and configuration via web interface		

***With high DALI traffic (e.g. during DALI-scan) increased current consumption may occur depending on the devices connected. Therefore, according to IEC62386-101 it is recommended to take an additional current of at least 20% for dynamic processes into account in system design.

LDALI-3E101-U, DALI-3E102-U, LDALI-3E104-U

Resource limits			
DALI ballasts per DALI channel	64	Address table entries	512 (non-ECS mode: 15)
DALI groups per DALI channel	16	LonMark calendars	1 (10 patterns) per DALI channel
DALI sensors per DALI channel	16	LonMark schedulers	16 per DALI channel
DALI button modules per DALI channel	64	LonMark alarm servers	1 per DALI channel
Scene control	16 scenes per DALI group	Trend logs	512 (13 000 000 entries, ≈ 200 MB)
Maths objects	100	Data points in trend log	1 000
Alarm logs	10	E-mail templates	100
OPC data points	10 000	Number of L-WEB clients	32 (simultaneously)
Connections (Local/Global)	2 000 / 250	Modbus data points	2 000
SMI devices (per channel)	16	Number of EnOcean devices	100
SMI devices (maximum)	64	EnOcean data points	1 000

Order number	Product description
LDALI-3E101-U	CEA-709/DALI Controller, AST, Sunblind Controller, 1 DALI channel, integrated DALI power supply
LDALI-3E102-U	CEA-709/DALI Controller, AST, Sunblind Controller, 2 DALI channels, integrated DALI power supply
LDALI-3E104-U	CEA-709/DALI Controller, AST, Sunblind Controller, 4 DALI channels, integrated DALI power supply
LIC-ASSET	Add-on Software License to activate asset tracking (for LDALI-ME20x-U, LDALI-3E10x-U, LDALI-PLCx, LROC-400, LROC-401, LIOB-AIR20, LIOB-591)
LDALI-PWR2-U	DALI power supply unit for 2 DALI channels
LDALI-PWR4-U	DALI power supply unit for 4 DALI channels
LDALI-MS2-BT	DALI multi-sensor (presence detection, illuminance sensor, IR receiver, temperature sensor, humidity sensor, 3 digital inputs, Bluetooth), up to 12 m mounting height
LDALI-MS3-BT	DALI multi-sensor (presence detection, illuminance sensor, IR receiver, temperature sensor, humidity sensor, 3 digital inputs, Bluetooth), up to 12 m mounting height
LDALI-MS4-BT	DALI multi-sensor (presence detection, illuminance sensor, IR receiver, temperature sensor, humidity sensor, 3 digital inputs, Bluetooth, flat lense), up to 5 m mounting height
LDALI-BM2	Quadruple DALI pushbutton coupler
LDALI-RM5	DALI Relay Module 10 A, Analog Interface 1 – 10 V
LDALI-RM6	DALI Relay Module 10 A, Analog Interface 1 – 10 V, "spud-mount"
LDALI-RM8	DALI Relay Module, 8-channel
LOY-DALI-SBM1	DALI Sunblind Module, DALI, 2 x 6A/250 V AC
LENO-800	EnOcean Interface 868 MHz Europe
LENO-801	EnOcean Interface 902 MHz USA/Canada
LENO-802	EnOcean Interface 928 MHz Japan
LWLAN-800	Wireless LAN Interface IEEE 802.11bgn
LSMI-804	Standard Motor Interface for 64 motors, 4 SMI channels via USB
LTE-800	LTE Interface
LRS232-802	USB to 2 x RS-232 Interface

LDALI-ME201-U, LDALI-ME202-U, LDALI-ME204-U

Datasheet #89021226

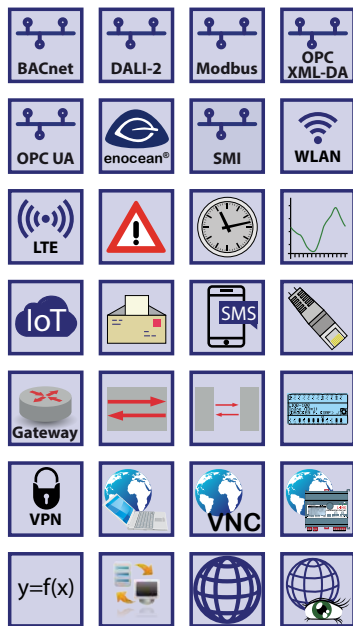

L-DALI Controllers are multifunctional devices combining constant light control, sunblind control and gateway functions between DALI (Digital Addressable Lighting Interface) and BACnet or Modbus systems. With Alarming, Scheduling, Trending and e-mail notification (AST™) the L-DALI Controller is a perfect solution for DALI lighting systems and for a smooth DALI integration into BACnet or Modbus networks.

DALI Network Interface

L-DALI Controllers act as a DALI-Master in the DALI network and can interact with DALI-2 multi-sensors and buttons in Multi-Master mode. The L-DALI Controllers features 1, 2, or 4 independent DALI channels. Up to 64 DALI or DALI-2 based luminaries per DALI channel can be controlled individually or via 16 groups. All luminaries are monitored for lamp or ballast defect. In addition up to 64 DALI-2 input devices are supported per DALI channel. Each input device can be equipped with push buttons, sliders, occupancy and light sensors.

Built-In DALI Bus Power Supply

All L-DALI models come with a built-in DALI bus power supply. The LDALI-ME201-U/LDALI-ME202-U can supply each DALI channel with a guaranteed supply current of 230 mA, the LDALI-ME204-U can supply 116 mA per channel. In case of the LDALI-ME204-U an external DALI bus power supply can be added to top up the supply current to 232 mA. External power supplies are available for up to four DALI channels. The internal DALI bus power can be switched on and off via web interface or LCD UI. Thanks to the switching power supply, these devices can handle input voltages from 85 – 240 V AC, 50 / 60 Hz.

BACnet Connectivity

The L-DALI Controllers feature connectivity in BACnet networks via BACnet/IP, BACnet/SC or BACnet MS/TP. They also provide data exchange through Global Connections and support comprehensive AST™ functionality (Alarming, Scheduling, and Trending). Full L-WEB integration is supported as well. The L-DALI Controllers are equipped with two Ethernet ports including a built-in Ethernet switch.

IoT Integration

The IoT function (Node.js) allows connecting the system to almost any cloud service, either for uploading historical data to analytics services, telemetry using MQTT, delivering alarm messages to alarm processing services or operating parts of the control system over a cloud service (e.g., scheduling based on Web calendars or booking systems). Processing Internet information such as weather data in forecast-based control is also possible. Finally, the JavaScript kernel also allows implementing serial protocols to non-standard equipment in primary plant control.

Local Operation and Override

The L-DALI Controllers come with a built-in backlit display (128x64) and a jog dial for local operation and override. Using the local operation, maintenance tasks (DALI device replacement, burn-in mode, etc.) can be executed without the need of any software tool.

Constant Light Control

The integrated Constant Light Controller works with DALI and with BACnet devices. It supports various lighting control strategies, presence and lux level based. Several parameters can be used to configure the Constant Light Controller for almost any use case.

Sunblind Control with Constant Light Control Interaction

The integrated Sunblind Controller application allows intelligent controlling of blinds connected via SMI (requires LSMI-804). It offers effective sun and anti-glare

Functions
L-WEB, L-STUDIO
L-ROC
L-INX
L-IOB
Gateways
LPAD-7, L-VIS, L-STAT
L-DALI
Routers, NIC
Interfaces
Accessories

LDALI-ME201-U, LDALI-ME202-U, LDALI-ME204-U

protection through active slat control and slat adjustment according to the sun position. Energy efficiency is ensured by linking room occupancy with sun protection. If a room is unoccupied, the L-DALI Controller opens or closes the sunblinds depending on the thermal requirements. This allows for instance to use the heat of the sun for heating in winter while in summer, the heat from the sun is reduced by the closed blinds to reduce the cooling load.

Optionally, the sunblind and light control applications of a room or an area can be linked together. As both applications control the light available in the room this holistic approach assures maximum comfort and energy efficiency.

In addition to the constant light and sunblind control, any mathematical calculation and function or logical operation (Boolean algebra) can be created on the device and process all available data points.

Device Configuration via Tool or Web Interface

The device configuration, commissioning, and parameterization is done either with the configuration tool software or via the integrated web server.

EnOcean, OPC and Modbus

EnOcean sensors and buttons can be integrated via the optional L-ENO EnOcean interface. To use the L-DALI with an existing SCADA solution all run-time values and parameters can be accessed via BACnet, OPC (XML/DA and UA) and Modbus TCP. With a LIC-MOD5 license up to 5 devices (e.g. L-STAT) can be connected via Modbus RTU (RS-485). 5, 10 or 15 devices can be connected via Modbus RTU (RS-485), the actual number of supported devices is dependent on the activated licenses (LIC-MOD5, LIC-MOD10 or both).

Advanced DALI Functions

- **DALI Sensors**

The L-DALI Controllers support the integration of DALI-2 multi-sensors for presence detection and light level recognition. In addition to the LOYTEC multi-sensors LDALI-MS2-BT/MS3-BT/MS4-BT, DALI-2 sensors of many well-known manufacturers can be used. For asset tracking in office buildings with the LOYTEC multi-sensors (LDALI-MSx-BT), a LIC-ASSET license is required.

- **DALI Buttons**

For manual operation, DALI-2 push button couplers, like the LDALI-BM2, DALI-2 operation panels and IR remote controls can be integrated into the system. Their functionality can be configured individually. In addition to controlling lighting via DALI (dimming, scene recall, etc.) and sunblinds via SMI (up, down, etc.), button press events can be propagated in the building network, triggering other, non-lighting related building automation functions. Support of feedback feature for pushbutton instances according to IEC 62386-332 is provided.

- **DALI Relay Modules**

Standard loads in the power grid can be controlled via DALI using DALI relay modules, like the LDALI-RM5, LDALI-RM6 and LDALI-RM8.

- **DALI Color Control**

The L-DALI allows controlling DALI luminaires with color control functionality (DT8). Both, tunable white (Tc) and full RGB color control (RGBWAF and xy-coordinate) are supported. Light color can either be changed automatically, via manual operation (e.g. buttons) or via the network.

- **Auto Burn-In for Fluorescent Lamps**

Fluorescent lamps must be operated about 100 hours with 100 % brightness before they may be dimmed. This burn-in process is monitored by L-DALI for

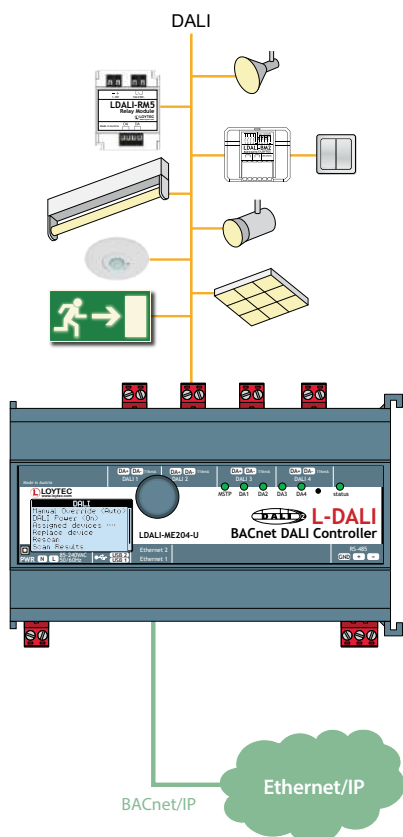

LDALI-ME201-U, LDALI-ME202-U, LDALI-ME204-U

each lamp. After 100 hours burn-in time, the lamp's constant light control is enabled.

- **Automatic Test of Emergency Lighting Systems**

In DALI emergency lighting systems based on IEC 62386-202, L-DALI can be used for testing the system. The results can be logged.

- **Collection of Important Operational Parameters**

For maximum transparency in the lighting system, L-DALI can record the operating hours of each lamp and also the energy consumption (calculated).

- **DALI Device Replacement made easy**

Defective DALI ballasts can easily be replaced directly on the L-DALI Controller (LCD and jog dial) or via the web interface. No software tool is necessary.

Smooth DALI Integration into BACnet and Modbus Networks

The L-DALI Controller maps information from the DALI network to BACnet objects or Modbus registers that are used to control DALI ballasts or to display operating states.

BACnet Interface

The following BACnet server objects are supported:

- Analog Output objects to control DALI ballasts, groups, and channels
- Multi-State Output objects for scene control of DALI groups and channels
- Analog Input objects providing feedback from DALI ballast, groups, and channels
- Analog Input objects providing status information from DALI groups and channels
- Accumulator objects providing estimated energy usage of DALI groups and channels
- Multi-State Output objects to issue commands (start/stop emergency test or burn-in, change color temperature, etc.) to DALI ballasts, groups and channels
- Analog Input objects providing battery status of emergency ballasts, groups
- Analog Input objects providing lux level information from supported DALI sensors (LDALI-MSx-BT: additionally humidity and temperature information is provided)
- Binary Input objects providing occupancy information from supported DALI sensors
- Loop objects providing constant light controller functionality
- Binary Input objects providing button information from supported DALI buttons
- Various objects to control sunblinds

All data points are available on the web server in a tree structure and can be displayed and set via a web browser.

Features

- DALI integration into BACnet networks
- Supports up to 64 DALI ballasts and 16 DALI groups per DALI channel
- Supports up to 64 input devices overall per channel
- Up to 16 DALI sensors per DALI channel are supported
- Up to 64 DALI button modules per DALI channel are supported
- Integrated DALI bus power supply
- Manual operation using the jog dial and local access to information about device status and data points in clear text and symbols
- 128x64 graphic display with backlight
- Built-in web server for device configuration
- Test and assignment of DALI devices on the web interface
- Replacement of DALI devices without additional software tools via LCD and jog dial
- Supports the control of standard loads in the power grid via LDALI-RM5, LDALI-RM6 or LDALI-RM8 Relay Modules
- Integrated Constant Light Controller
- Integrated Sunblind Controller
- Supports DALI-2 devices (drivers and input devices)
- DALI-2 certified (compliant with IEC 62386-101 and IEC 62386-103)
- Supports DALI color control (DT8 tunable white & full color control)
- Supports lamp burn-in mode
- Supports periodic testing of DALI emergency lights

LDALI-ME201-U, LDALI-ME202-U, LDALI-ME204-U

- Integrated DALI Protocol Analyzer
- Compliant with ANSI/ASHRAE 135-2012 and ISO 16484-5:2012 standard
- Supports BACnet/IP, BACnet/SC or BACnet MS/TP
- BACnet Client Function (Write Property, Read Property, COV Subscription)
- B-BC (BACnet Building Controller) functionality, BTL certified
- Alarming, Scheduling, and Trending (AST™) locally or embedded in L-WEB (building management)
- Node.js support for easy IoT integration (e.g. Google calendar, MQTT, Alexa & friends, multimedia equipment,...)
- Event-driven e-mail notification
- Supports Local and Global Connections
- Stores customized graphical pages
- Visualization of customized graphical pages through LWEB-900 (Building Management), LWEB-803 (Monitoring and Control), or LWEB-802 (Web Browser)
- Stores user-defined project documentation
- Dual Ethernet/IP interface
- Built-in OPC XML-DA and OPC UA server
- Modbus TCP (Master or Slave)
- Supports SMI (Standard Motor Interface) through LSMI-804
- Connection to EnOcean wireless devices via LENO-80x Interface
- Supports WLAN through LWLAN-800 Interface
- Supports LTE through LTE-800 Interface
- Supports RS-232 through LRS232-802 Interface
- Modbus RTU/ASCII for 5 devices (LIC-MOD5 required), 10 devices (LIC-MOD10 required) or 15 devices (LIC-MOD5 and LIC-MOD10 required)
- Configurable Bluetooth beacons and services: indoor navigation, asset tracking (requires LIC-ASSET license) and access to LWEB-900 room control solution

Specifications			
Type	LDALI-ME201-U	LDALI-ME202-U	LDALI-ME204-U
Dimensions (mm)	159 x 100 x 75 (L x W x H), DIM035		
Installation	DIN rail mounting following DIN 43880, top hat rail EN 50022		
Power supply	85-240 V AC, 50/60 Hz, typ. 9W (4W + 5W DALI)	85-240 V AC, 50/60 Hz, typ. 14W (4W + 2 x 5 W)	85-240 V AC, 50/60 Hz, typ. 14W (4W + 4 x 2.5W DALI)
Operating conditions	0 °C to 40 °C, 10 – 90 % RH, noncondensing, degree of protection: IP40, IP20 (terminals)		
DALI channels	1	2	4
Integrated DALI bus power supply (per channel)	16 VDC 230 mA guaranteed supply current ¹ 250 mA max. supply current	16 VDC 230 mA guaranteed supply current ¹ 250 mA max. supply current	16 VDC 116 mA guaranteed supply current ¹ 125 mA max. supply current
Certificates	DALI-2	DALI-2	DALI-2
Interfaces	2 x Ethernet (100Base-T): OPC XML-DA, OPC UA, BACnet/IP*, BACnet/SC*, Modbus TCP, HTTP, FTP, SSH, HTTPS, Firewall, VNC, SNMP 1 x RS-485 (ANSI TIA/EIA-485): BACnet MS/TP* or Modbus RTU/ASCII (Master or Slave)** 2 x USB-A: WLAN (needs LWLAN-800), EnOcean (needs LENO-80x), SMI (needs LSMI-804), LTE (needs LTE-800) * Either BACnet/IP, BACnet/SC or BACnet MS/TP ** Requires LIC-MOD5/LIC-MOD10 software license		
Tools	L-INX Configurator and configuration via web interface		

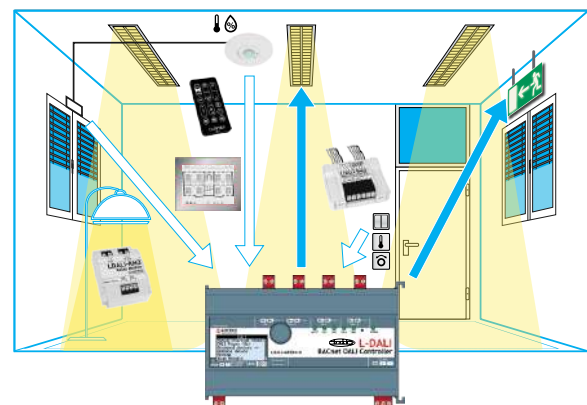
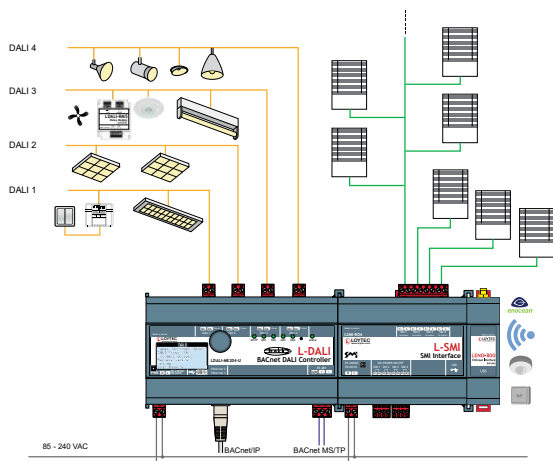

¹ With high DALI traffic (e.g. during DALI-scan) increased consumption may occur depending on the devices connected. Therefore, according to IEC62386-101 it is recommended to take an additional current of at least 20% for dynamic processes into account in system design.

LDALI-ME201-U, LDALI-ME202-U, LDALI-ME204-U

Resource limits			
DALI ballasts per DALI channel	64	BACnet server objects	1 000 per channel
DALI groups per DALI channel	16	BACnet client mappings	1 000
DALI sensors per DALI channel	16	BACnet scheduler objects	100
DALI button modules per DALI channel	64	BACnet calendar objects	25
Scene control	16 scenes per DALI group	BACnet notification classes	32
Math objects	100	Trend logs	512 (13 000 000 entries, ≈ 200 MB)
Alarm logs	10	Data points in trend log	1 000
OPC data points	10 000	E-mail templates	100
Connections (Local/Global)	2 000 / 250	Modbus data points	2 000
SMI devices (per channel)	16	Number of EnOcean devices	100
SMI devices (maximum)	64	EnOcean data points	1 000
Number of L-WEB clients	32 (simultaneously)		

Order number	Product description		
LDALI-ME201-U	BACnet/DALI Controller, 1 DALI channel, integrated DALI power supply		
LDALI-ME202-U	BACnet/DALI Controller, 2 DALI channels, integrated DALI power supply		
LDALI-ME204-U	BACnet/DALI Controller, 4 DALI channels, integrated DALI power supply		
LIC-ASSET	Add-on Software License to activate asset tracking (for LDALI-ME20x-U, LDALI-3E10x-U, LDALI-PLCx, LROC-400, LROC-401, LIOB-AIR20, LIOB-591)		
LIC-MOD5	Add-on license to enable 5 Modbus devices		
LIC-MOD10	Add-on license to enable 10 Modbus devices		
LDALI-PWR2-U	DALI power supply unit for 2 DALI channels		
LDALI-PWR4-U	DALI power supply unit for 4 DALI channels		
LDALI-MS2-BT	DALI multi-sensor (presence detection, illuminance sensor, IR receiver, temperature sensor, humidity sensor, 3 digital inputs, Bluetooth), up to 12 m mounting height		
LDALI-MS3-BT	DALI multi-sensor (presence detection, illuminance sensor, IR receiver, temperature sensor, humidity sensor, 3 digital inputs, Bluetooth), up to 12 m mounting height		
LDALI-MS4-BT	DALI multi-sensor (presence detection, illuminance sensor, IR receiver, temperature sensor, humidity sensor, 3 digital inputs, Bluetooth, flat lense), up to 5 m mounting height		
LDALI-BM2	Quadruple DALI pushbutton coupler		
LDALI-RM5	DALI Relay Module 10 A, Analog Interface 1 – 10 V		
LDALI-RM6	DALI Relay Module 10 A, Analog Interface 1 – 10 V, "spud-mount"		
LDALI-RM8	DALI Relay Module, 8-channel		
LOY-DALI-SBM1	DALI Sunblind Module, DALI, 2 x 6A/250 V AC		
LENO-800	EnOcean Interface 868 MHz Europe		
LENO-801	EnOcean Interface 902 MHz USA/Canada		
LENO-802	EnOcean Interface 928 MHz Japan		
LWLAN-800	Wireless LAN Interface IEEE 802.11 bgn		
LSMI-804	Standard Motor Interface for 64 motors, 4 SMI channels via USB		
LTE-800	LTE Interface		
LRS232-802	USB to 2 x RS-232 Interface		

Functions
L-WEB, L-STUDIO
L-ROC
L-INX
L-IOB
Gateways
LPAD-7, L-VIS, L-STAT
L-DALI
Routers, NIC
Interfaces
Accessories

- ✓ BACnet
- ✓ CEA-709
- ✓ KNX
- ✓ DALI
- M-Bus
- ✓ OPC



Programmable DALI Controller

LDALI-PLC2/LDALI-PLC4

Datasheet #89055225

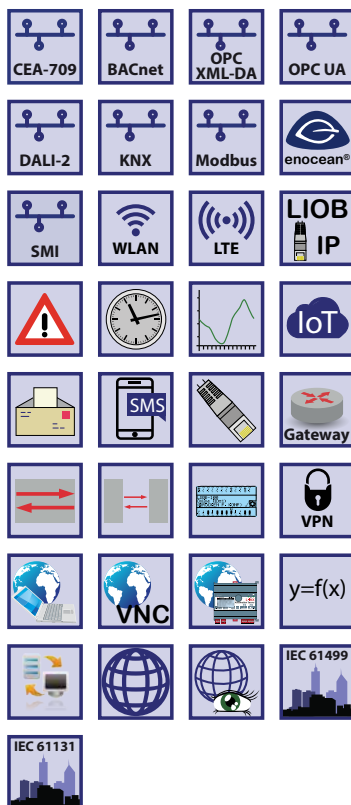

The LDALI-PLC2/PLC4 controllers are powerful, programmable lighting controllers, which can be programmed by L-STUDIO. With Alarming, Scheduling, Trending and e-mail notification (AST™) the LDALI-PLC2/PLC4 controller is a perfect solution for DALI lighting systems with application requirements not covered by the standard application of the non-programmable L-DALI controllers.

DALI Network Interface

L-DALI Controllers act as a DALI-Master in the DALI network and can interact with DALI-2 multi-sensors and buttons in Multi-Master mode. The LDALI-PLC2/PLC4 is equipped with 2/4 independent DALI channels. Up to 64 DALI or DALI-2 based luminaries per DALI channel can be controlled individually or via 16 groups. All luminaries are monitored for lamp or ballast defect. In addition up to 64 DALI-2 input devices are supported per DALI channel. Each input device can be equipped with push buttons, sliders, occupancy and light sensors.

Built-In DALI Bus Power Supply

The LDALI-PLC4 comes with a built-in DALI bus power supply, which can supply each DALI channel with a guaranteed supply current of 116 mA. An external DALI bus power supply can be added to top up the supply current to 232 mA. External power supplies are available for up to four DALI channels. The LDALI-PLC2 provides a DALI-bus power supply with guaranteed supply current of 230mA per channel. The internal DALI bus power can be switched on and off via web interface or LCD UI. Thanks to the switching power supply, these devices can handle input voltages from 85 – 240 V AC, 50/60 Hz.

Local Operation and Override

The L-DALI Controllers come with a built-in backlit display (128x64) and a jog dial for local operation and override. Using the local operation, maintenance tasks (DALI device replacement, burn-in mode, etc.) can be executed without the need of any software tool.

Programmable

The LDALI-PLC2/PLC4 can be programmed using the L-STUDIO programming tool. It can be programmed using IEC 61499 for integration into the L-ROC system and IEC 61131 for stand-alone operation.

IEC 61131 lighting control library available

A library containing standard lighting control functionality is available. It supports various lighting control strategies, presence and lux level based. Several parameters can be used to configure the application for almost any use case. User specific program extensions are possible as well.

Connectivity

The LDALI-PLC2/PLC4 controller provides connectivity functions to concurrently integrate CEA-709 (LonMark Systems), BACnet, KNX, and Modbus subsystems. LonMark Systems can be integrated via IP-852 (Ethernet/IP). BACnet integration is supported through BACnet/IP (Ethernet/IP) or BACnet MS/TP (RS-485), KNXnet/IP and Modbus TCP via Ethernet/IP.

The gateway functionality allows data communication between all communication technologies available on the device. Different technology data points are mapped through Local Connections on the device. The mapping of different technology data points on distributed devices is supported by Global Connections.

Each L-DALI Controller is equipped with two Ethernet ports. It can either be configured to use the internal switch to interconnect the two ports or every port is configured to work in a separate IP network.

When the Ethernet ports are configured for two separate IP networks, one port can be connected for instance to a WAN (Wide Area Network) with enabled network security (HTTPS) while the second port can be configured to be connected

- Functions
- L-WEB, L-STUDIO
- L-ROC
- L-INX
- L-IOB
- Gateways
- L-VIS, L-STAT
- L-DALI
- Routers, NIC
- Interfaces
- Accessories

to an insecure network (LAN) where the standard building automation protocols like BACnet/IP, BACnet/SC, LON/IP, or Modbus TCP are present. These devices also feature fire-wall functionality to isolate particular protocols or services between the ports.

Using the internal switch, a daisy chained line topology of up to 20 devices can be built, which reduces costs for network installation. The IP switch also allows the setup of a redundant Ethernet installation (ring topology), which increases reliability. The redundant Ethernet topology is enabled by the Rapid Spanning Tree Protocol (RSTP), which is supported by most managed switches.

The L-DALI Controllers provide fully featured AST™ functionality (Alarming, Scheduling, and Trending) and can be integrated perfectly into the L-WEB System.

IoT Integration

The IoT function (Node.js) allows connecting the system to almost any cloud service, either for uploading historical data to analytics services, telemetry using MQTT, delivering alarm messages to alarm processing services or operating parts of the control system over a cloud service (e.g., scheduling based on Web calendars or booking systems). Processing Internet information such as weather data in forecast-based control is also possible. Finally, the JavaScript kernel also allows implementing serial protocols to non-standard equipment in primary plant control.

Device Configuration via Tool or Web Interface

The device configuration, commissioning, and parameterization is done either with the configuration tool software or via the integrated web server.

EnOcean, SMI and LIOB/IP

Wireless EnOcean sensors and buttons can be integrated via the optional L-ENO EnOcean interface. For sunblinds the LSMI-804 extension module allows the integration of up to four SMI channels. Physical I/Os can be integrated through L-IOB I/O Modules via LIOB-IP.

Advanced DALI Functions

- **DALI Sensors**

The L-DALI Controllers support the integration of DALI-2 multi-sensors for presence detection and light level recognition. In addition to the LOYTEC multi-sensors LDALI-MS2-BT/MS3-BT/MS4-BT, DALI-2 sensors of many well-known manufacturers can be used. For asset tracking in office buildings with the LOYTEC multi-sensors (LDALI-MSx-BT), a LIC-ASSET license is required.

- **DALI Buttons**

For manual operation, DALI-2 push button couplers, like the LDALI-BM2, DALI-2 operation panels, and IR remote controls can be integrated into the system. The function executed when a button is pressed is programmable in the program logic. In addition the feedback feature for pushbutton instances according to IEC 62386-332 is supported.

- **DALI Relay Modules**

Standard loads in the power grid can be controlled via DALI using DALI relay modules, like the LDALI-RM5, LDALI-RM6 and LDALI-RM8.

- **DALI Color Control**

The L-DALI allow controlling DALI luminaires with color control functionality (DT8). Both, tunable white (Tc) and full RGB color control (RGBWAF and xy-coordinate) are supported. Changing the light colour is possible via scenes or controlled via the program logic.

- **Auto Burn-In for fluorescent Lamps**

Fluorescent lamps must be operated about 100 hours with 100 % brightness before they may be dimmed. This burn-in process is monitored by L-DALI for each lamp. After 100 hours burn-in time, the lamp's constant light control is enabled.

• **Automatic Test of Emergency Lighting Systems**

In DALI emergency lighting systems based on IEC 62386-202, L-DALI can be used for testing the system. The results can be logged.

• **Collection of important Operational Parameters**

For maximum transparency in the lighting system, L-DALI can record the operating hours of each lamp and also the energy consumption (calculated).

• **DALI Device Replacement made easy**

Defective DALI ballasts can easily be replaced directly on the L-DALI Controller (LCD and jog dial) or via the web interface. No software tool is necessary.

Features

- Programmable with L-STUDIO IEC 61131-3 and IEC 61499
- Supports up to 64 DALI ballasts and 16 DALI groups per DALI channel
- Supports up to 64 input devices overall per channel
- Up to 16 DALI sensors per DALI channel are supported
- Up to 64 DALI button modules per DALI channel are supported
- Integrated DALI bus power supply
- DALI-2 certified
- Manual operation using the jog dial and local access to information about device status and data points in clear text and symbols
- 128x64 graphic display with backlight
- Built-in web server for device configuration
- Test and assignment of DALI devices on the web interface
- Replacement of DALI devices without additional software tools via LCD and jog dial
- Supports the control of standard loads in the power grid via LDALI-RM5/RM6/RM8 Relay Modules
- Supports DALI-2 devices (drivers and input devices)
- Support DALI color control (DT8 tunable white & full color control)
- Supports lamp burn-in mode
- Supports periodic testing of DALI emergency lights
- Integrated DALI Protocol Analyzer
- Physical inputs and outputs with L-IOB I/O Modules
- Compliant with CEA-709, CEA-852, and ISO/IEC 14908 Standard (LonMark System)
- Support of dynamically created or static NVs
- Support of user-defined NVs (UNVTs) and Configuration Properties (SCPTs, UCPTs)
- KNXnet/IP
- Gateway functions including Smart Auto-Connect™
- Modbus TCP and Modbus RTU/ASCII
- Compliant with ANSI/ASHRAE 135-2012 and ISO 16484-5:2012 standard
- Supports BACnet/IP, BACnet/SC or BACnet MS/TP
- BACnet Client Function (Write Property, Read Property, COV Subscription)
- B-BC (BACnet Building Controller) functionality, BTL certified
- Alarming, Scheduling, and Trending (AST™) locally or embedded in L-WEB (building management)
- Node.js support for easy IoT integration (e.g. Google calendar, MQTT, Alexa & friends, multimedia equipment,...)
- Event-driven e-mail notification
- Supports Local and Global Connections
- Built-in OPC XML-DA and OPC UA server
- Stores customized graphical pages
- Visualization of customized graphical pages through LWEB-900 (building Management), LWEB-803 (Monitoring and Control), or LWEB-802 (Web Browser)
- Stores user-defined project documentation
- Dual Ethernet/IP interface
- Supports SMI (Standard Motor Interface) through LSMI-804
- Connection to EnOcean wireless devices via LENO-80x Interface
- Supports WLAN through LWLAN-800 Interface
- Supports LTE through LTE-800 Interface
- Supports RS-232 through LRS232-802 Interface
- Configurable Bluetooth beacons and services: indoor navigation, asset tracking (requires LIC-ASSET license) and access to LWEB-900 room control solution

Runtime licenses

Type	LDALI-PLC2	LDALI-PLC4
Programming, Tools	L-STUDIO (IEC 61131-3 and IEC 61499 based), L-INX Configurator and configuration via web interface	
License	L-STUDIO: included	

Programmable DALI Controller

LDALI-PLC2/LDALI-PLC4

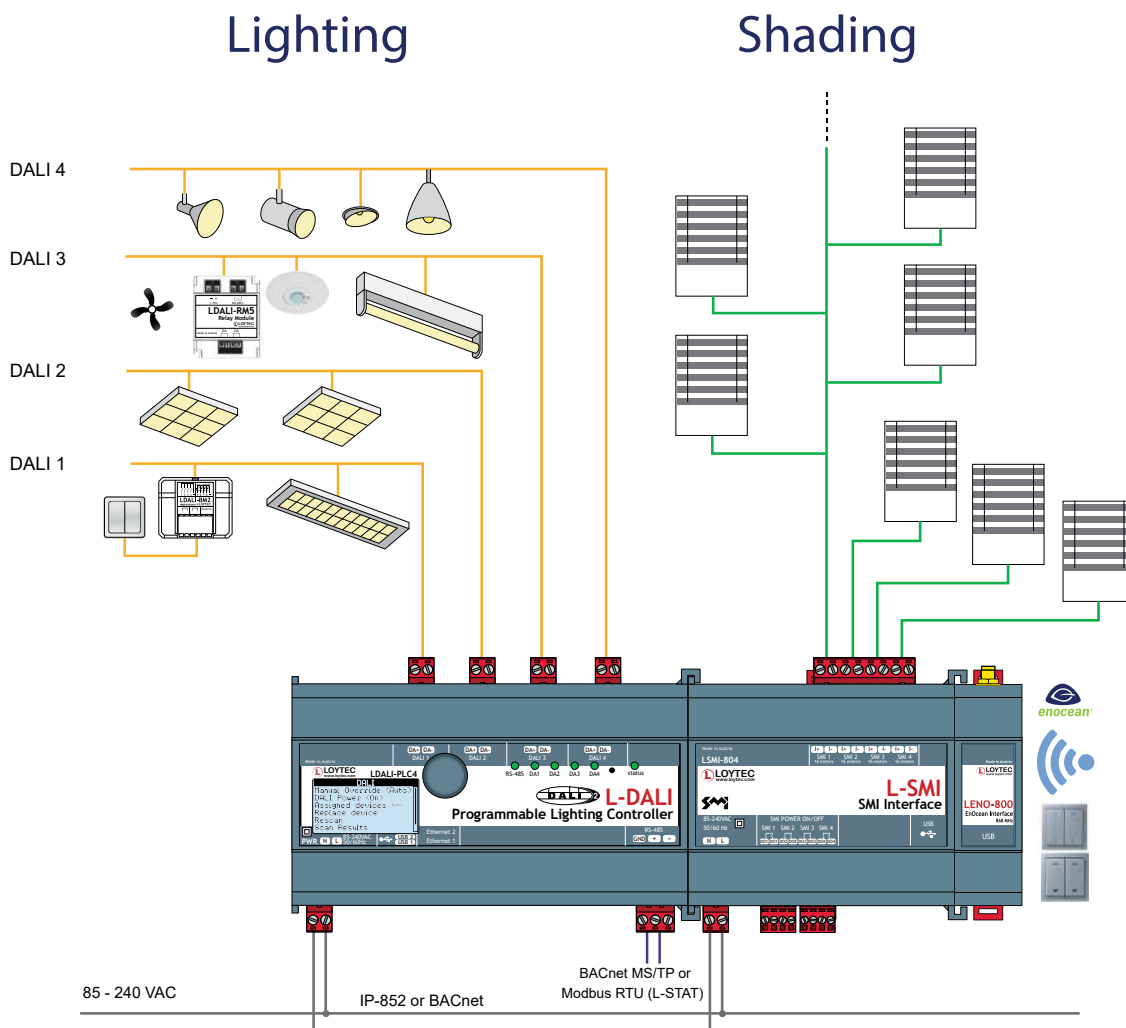

Specifications

Type	LDALI-PLC2	LDALI-PLC4
Dimensions (mm)	159 x 100 x 75 (L x W x H), DIM035	
Installation	DIN rail mounting following DIN 43880, top hat rail EN 50022	
Power supply	85-240 V AC, 50/60 Hz, typ. 14W (4W + 2 x 5W DALI)	85-240 V AC, 50/60 Hz, typ. 14W (4W + 4 x 2.5W DALI)
Operating conditions	0 °C to 40 °C, 10 – 90 % RH, noncondensing, degree of protection: IP40, IP20 (terminals)	
Interfaces	2 x Ethernet (100Base-T): OPC XML-DA, OPC UA, LonMark IP-852, BACnet/IP*, BACnet/SC*, LIOB-IP, KNXnet/IP, Modbus TCP (Master or Slave), HTTP, FTP, SSH, HTTPS, Firewall, VNC, SNMP * Either BACnet/IP, BACnet/SC or BACnet MS/TP	1 x RS-485 (ANSI TIA/EIA-485): BACnet MS/TP*, or Modbus RTU/ASCII (Master or Slave) 2 x USB-A: WLAN (needs LWLAN-800), EnOcean (needs LENO-80x) SMI (needs LSMI-804), LTE (needs LTE-800)
DALI channels	2	4
Integrated DALI bus power supply (per channel data)	16 VDC 230 mA guaranteed supply current*** 250 mA max. supply current	16 VDC 116 mA guaranteed supply current*** 125 mA max. supply current
Max. number of Rooms/Segments	16	32

***With high DALI traffic (e.g. during DALI-scan) increased current consumption may occur depending on the devices connected. Therefore, according to IEC62386-101 it is recommended to take an additional current of at least 20% for dynamic processes into account in system design.

Resource limits			
Total number of data points	30 000	LonMark Alarm Servers	1
OPC data points	10 000	E-mail templates	100
BACnet objects	2 000 (analog, binary, multi-state)	Math objects	100
BACnet client mappings	5 000	Alarm logs	10
BACnet calendar objects	25	KNXnet/IP data points	1 000
BACnet scheduler objects	100 (64 data points per object)	Connections (Local / Global)	2 000 / 250
BACnet notification classes	32	Number of L-WEB clients	32 (simultaneously)
Trend logs (BACnet or generic)	512 (13 000 000 entries, ≈ 200 MB)	Modbus data points	4 000
Total trended data points	2 000	L-IOB I/O Modules	24
CEA-709 network variables (NVs)	1 000	Number of EnOcean devices	100
CEA-709 Alias NVs	2 000	EnOcean data points	1 000
CEA-709 External NVs (polling)	2 000	DALI ballasts per channel	64
CEA-709 address table entries	1 000 (non-ECS mode: 15)	DALI groups per channel	16
LonMark Calendars	1 (25 calendar patterns)	DALI sensors per channel	16
LonMark Schedulers	100	DALI button modules per channel	64

Order number	Product description
LDALI-PLC2	Programmable DALI Controller, 2 DALI channels, integrated DALI power supply
LDALI-PLC4	Programmable DALI Controller, 4 DALI channels, integrated DALI power supply
L-STUDIO	Development and integration platform for programmable LOYTEC controllers
LIC-ASSET	Add-on Software License to activate asset tracking (for LDALI-ME20x-U, LDALI-3E10x-U, LDALI-PLCx, LROC-400, LROC-401, LIOB-AIR20, LIOB-591)
LDALI-PWR2-U	DALI power supply unit for 2 DALI channels
LDALI-PWR4-U	DALI power supply unit for 4 DALI channels
LDALI-MS2-BT	DALI multi-sensor (presence detection, illuminance sensor, IR receiver, temperature sensor, humidity sensor, 3 digital inputs, Bluetooth), up to 12 m mounting height
LDALI-MS3-BT	DALI multi-sensor (presence detection, illuminance sensor, IR receiver, temperature sensor, humidity sensor, 3 digital inputs, Bluetooth), up to 12 m mounting height
LDALI-MS4-BT	DALI multi-sensor (presence detection, illuminance sensor, IR receiver, temperature sensor, humidity sensor, 3 digital inputs, Bluetooth, flat lense), up to 5 m mounting height
LDALI-BM2	Quadruple DALI pushbutton coupler
LDALI-RM5	DALI Relay Module 10 A, Analog Interface 1 – 10 V
LDALI-RM6	DALI Relay Module 10 A, Analog Interface 1 – 10 V, "spud-mount"
LDALI-RM8	DALI Relay Module, 8-channel
LOY-DALI-SBM1	DALI Sunblind Module, DALI, 2 x 6A/250 V AC
LENO-800	EnOcean Interface 868 MHz Europe
LENO-801	EnOcean Interface 902 MHz USA/Canada
LENO-802	EnOcean Interface 928 MHz Japan
LWLAN-800	Wireless LAN Interface IEEE 802.11 bgn
LSMI-804	Standard Motor Interface for 64 motors, 4 SMI channels via USB
LTE-800	LTE Interface
LRS232-802	USB to 2 x RS-232 Interface
LSTAT-800-G3-Lx	Room Operator Panel, black front, white enclosure, Modbus, temperature, rel. humidity, ext. switch/NTC, IR receiver, Buttons (Lx)
LSTAT-801-G3-Lx	Room Operator Panel, front black, white enclosure, Modbus, temperature, rel. humidity, ext. switch/NTC, occupancy, IR receiver, Buttons (Lx)
LSTAT-802-G3-Lx	Room Operator Panel, front black, white enclosure, Modbus, temperature, rel. humidity, ext. switch/NTC, occupancy, IR receiver, CO2, Buttons (Lx)
LSTAT-800-G3-L20x	Room Operator Panel, white front, white enclosure, Modbus, temperature, rel. humidity, ext. switch/NTC, IR receiver, Buttons (Lx)
LSTAT-801-G3-L20x	Room Operator Panel, white front, white enclosure, Modbus, temperature, rel. humidity, ext. switch/NTC, occupancy, IR receiver, Buttons (Lx)
LSTAT-802-G3-L20x	Room Operator Panel, white front, white enclosure, Modbus, temperature, rel. humidity, ext. switch/NTC, occupancy, IR receiver, CO2, Buttons (Lx)
LSTAT-80x-CUSTOM	One-time customization cost for L-STAT custom design, including 2 working samples

LDALI-PWR1-U

Datasheet #89087901



The LDALI-PWR1-U is a DALI power supply for one channel with a guaranteed supply current of 50 mA (maximum supply current of 62 mA).

It is well suited as supply for small standalone DALI-systems with a limited amount of DALI-components or even for luminaire integration. A typical LOYTEC application is the supply of a DALI subsystem in a BT-mesh ecosystem (e.g. for a room), in which the sensor acts as DALI application controller and gateway to the mesh ecosystem. However, the LDALI-PWR1-U can also be used only to supply the LOYBT-MSx Bluetooth multisensors.

In applications with higher DALI currents up to 4 LDALI-PWR1-U can be used in parallel, resulting in a guaranteed supply current of 200 mA (maximum supply current of 248 mA).

Installation

The DALI channel is treated to be non-SELV (Safety Extra Low Voltage). Therefore the relevant installation regulations for low voltage apply. The cable of a DALI channel is either limited to a maximum length of 300 m using a minimum wire cross-section of 1.5 mm² (AWG15) or must ensure a maximal voltage drop of 2 V.

Wide Range Supply Voltage

The power supply accepts a wide range of supply voltage from 85–240 VAC, 50/60 Hz, and also features a starting-current limitation.

DALI Power Output

The DALI power output provides 16 V (11 V – 20.5 V) and 50 mA guaranteed supply current. The power output is isolated from mains by reinforced insulation. The power output is short circuit proof and shuts down if thermally overloaded.

The LDALI-PWR1-U is DALI-2 certified.

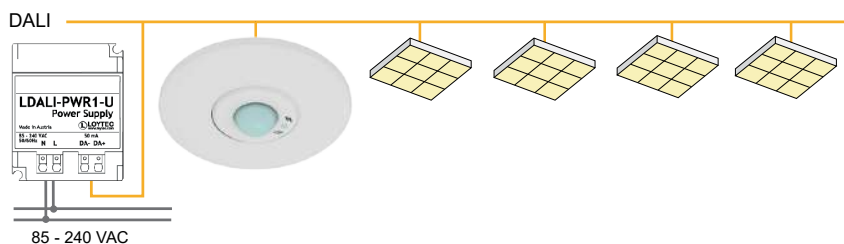

Specifications	
Dimensions (mm)	51 x 41 x 21 (L x W x H), DIM043
Installation	Installation in distribution boxes, mounting in false ceilings or luminaire integration
Power supply	85-240 V AC, 50/60 Hz, current limited startup, max. 1.7 W
Operating conditions	0 °C to 40 °C, 10 – 90 % RH, noncondensing, degree of protection: IP40, IP20 (terminals)
Interfaces	1 x 16 V DC (11 V – 20.5 V), 50 mA guaranteed supply current, 62 mA max. supply current, 30 ms start-up time, short-circuit proof, thermal overheat protection, reinforced insulation (not SELV) to the power line
Certificates	DALI-2

Order number	Product description
LDALI-PWR1-U	DALI power supply unit for 1 DALI channel, 50 mA

LDALI-PWR2-U, LDALI-PWR4-U

Datasheet #89023222

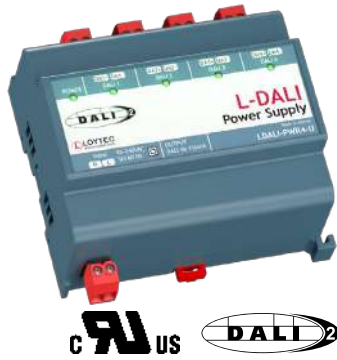

The DALI-2 power supplies LDALI-PWR2-U and LDALI-PWR4-U are used to power two or four DALI channels. Per channel, the power supplies provide a guaranteed supply current of 116 mA to power devices connected to the DALI channel.

In case the DALI devices connected to the channel consume more than the 116 mA, two DALI outputs of the power supplies can be used in parallel, resulting in a guaranteed supply current of 232 mA (maximum supply current of 250 mA).

Installation

The DALI channel is treated to be non-SELV (Safety Extra Low Voltage). Therefore the relevant installation regulations for low voltage apply. The cable of a DALI channel is either limited to a maximum length of 300 m using a minimum wire cross-section of 1.5 mm² (AWG15) or must ensure a maximal voltage drop of 2 V.

Wide Range Supply Voltage

The power supplies accept a wide range of supply voltage from 85-240 V AC, 50/60 Hz. They also feature a starting-current limitation.

DALI Power Outputs

The DALI power outputs provide 18 V (11 V – 20.5 V) and 116 mA guaranteed supply current. The power outputs are isolated from mains by reinforced insulation. The power outputs are short circuit proof and shut down if thermally overloaded. When a thermal overload occurs, the DALI control lamp switches off.

The LDALI-PWR2-U and LDALI-PWR4-U are DALI-2 certified.

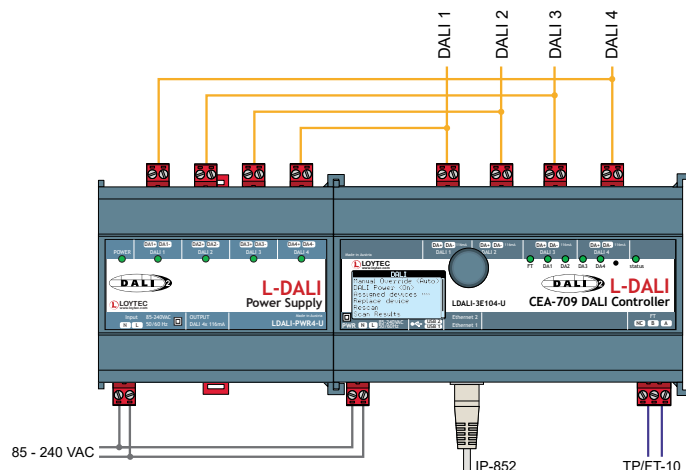

Specifications	
Dimensions (mm)	107 x 100 x 60 (L x W x H), DIM023
Installation	DIN rail mounting following DIN 43880, top hat rail EN 50022
Power supply	85-240 V AC, 50/60 Hz, current limited start up, max. 12 W
Operating conditions	0 °C to 40 °C, 10 – 90 % RH, noncondensing, degree of protection: IP40, IP20 (terminals)
Interfaces	LDALI PWR2-U: 2 x 18 V DC (11 V – 20.5 V), each 116 mA guaranteed supply current***, 125 mA max. supply current, 7 ms start-up time, short-circuit-proof, thermal overheat protection, reinforced insulation (not SELV) to the power line LDALI PWR4-U: 4 x 18 V DC (11 V – 20.5 V), each 116 mA guaranteed supply current***, 125 mA max. supply current, 7 ms start-up time, short-circuit-proof, thermal overheat protection, reinforced insulation (not SELV) to the power line
Certificates	DALI-2
Order number	Product description
LDALI-PWR2-U	DALI power supply unit for 2 DALI channels
LDALI-PWR4-U	DALI power supply unit for 4 DALI channels

***With high DALI traffic (e.g. during DALI-scan) increased current consumption may occur depending on the devices connected. Therefore, according to IEC62386-101 it is recommended to take an additional current of at least 20% for dynamic processes into account in system design.

Infrared Remote Control

L-RC1

Datasheet #89060423



The L-RC1 is an infrared remote control, optimized for room automation applications. It allows the control of the room's lights, sunblinds and HVAC system.

It supports the individual control for up to two channels – groups of luminaires and blinds – and scene control for up to three scenes.

For HVAC applications the temperature setpoint and fan speed can be adjusted, A/C can be switched on and off and the room's occupancy status can be changed.

The L-RC1 is designed to work with L-DALI multi-sensors (LDALI-MSx-BT) and L-STAT Room Operator Panels.

Features

- Infrared remote control optimized for room automation applications
- Control up to two light channels
- Control up to two sunblind channels
- Scene control for up to three scenes
- Adjust temperature setpoint
- Adjust fan speed
- Set occupancy status
- Switch A/C on/off

Specifications

Dimensions (mm)	40.5 x 86.4 x 7.20 (L x W x H), DIM039
Power supply	1 x CR2025 3.0 V button battery
Operating conditions	0 °C to 40 °C, 10 – 90 % RH, noncondensing
Interfaces	IR transmitter, 38±0.5 KHz, NEC standard IR format
Keys	18
For use with	LDALI-MSx-BT, LSTAT-800-Gx-Lx, LSTAT-801-Gx-Lx, LSTAT-802-Gx-Lx, L-STAT-80x-CUSTOM

Order number

Product description

L-RC1	Infrared remote control for room automation applications
-------	--

LDALI-MS2-BT / LDALI-MS3-BT / LDALI-MS4-BT

Datasheet #89094001



The LOYTEC LDALI-MS2/MS3/MS4-BT multi-sensor performs occupancy detection and measures the illuminance level. It integrates perfectly into the L-DALI product line of lighting controllers and LROC-40x room automation controllers. The occupancy sensor uses a passive infrared presence detector and a digital microphone. The sensor is optimized for use in typical office environments where even the small movements of somebody working at a desk and hitting the keyboard have to be detected across the complete detection area.

The LDALI-MS2/MS3-BT provides a presence detection zone diameter of 10.8 m at 3 m mounting height and is ideal to cover a typical office room or an area in an open office space. As well it is suitable for highbay-applications for mounting heights up to 12 m. The detection area for mounting heights from 5 m to 12 m is 256 m².

The LDALI-MS4-BT provides a flat lense and the presence detection zone diameter is 7 m at 3 m mounting height.

With the built-in infrared receiver, the room's lights, sunblinds and HVAC system can be controlled via the optionally available IR remote control L-RC1. In addition to occupancy and illuminance sensors, the LDALI-MS2/MS3/MS4-BT comes with integrated temperature and humidity sensors. In room automation applications, those values can be used to calculate the current dew point. On the back of the sensor, there is a connector for three digital inputs, allowing to connect conventional switches and push-buttons, window contacts, dew point sensor, etc. This feature not only saves on additional hardware, but also significantly reduces wiring costs, as the inputs can be wired inside the room and wires no longer have to be pulled to the I/O modules in the switching cabinet.

Furthermore, the LDALI-MS2/MS3/MS4-BT can transmit all supported beacon types (iBeacon, Eddystone UID beacon or manufacturer specific LOYTEC beacon) for indoor localization.

The LDALI-MS2-BT comes with three mounting options: It can be mounted in-wall in standard flush-mounted boxes, spring snap in false ceilings and on-wall with the included surface mounting box. The LDALI-MS3/MS4-BT is designed to be used with spring snaps in false ceilings.

Communication and power supply is handled via the DALI bus. The LDALI-MS2/MS3/MS4-BT is a DALI-2 certified multi-sensor as defined in the IEC 62386 (2014) standard and can be integrated into DALI-2 systems of other vendors.

Features

- Easy integration into LOYTEC L-DALI lighting systems and LROC-40x room automation controllers with a special focus on lighting control and reducing energy costs
- DALI-2 certified input device, according to IEC62386-101, IEC62386-103, IEC62386-301, IEC62386-303 and IEC62386-304
- High sensitivity occupancy detection – dual technology (PIR and acoustic, separate sensitivity parameter for each technology, sensitivity adjustable), optimized for office applications
- Illuminance measurement
- Built-in infrared receiver for optional infrared remote control L-RC1
- Temperature sensor
- Humidity sensor
- 3 digital inputs (dry contact)
- Configurable Bluetooth beacons and services: indoor navigation, asset tracking and access to LWEB-900 room control solution
- The LDALI-MS3/MS4-BT can be mounted directly in false ceilings (spring mount included).
- The LDALI-MS2-BT can be mounted in a flush-mounted box, directly in false ceilings (spring mount included) or on-wall (mounting kit LOYMS2-OW must be ordered separately).
- Multi-master compatible, up to 16 LDALI-MS2/MS3/MS4-BT sensors per DALI channel given a sufficiently dimensioned bus supply
- Supplied via the DALI bus, no external power supply required
- Sensor head of the LDALI-MS2/MS3-BT can be tilted up to $\pm 15^\circ$ vertically
- Flat lense in LDALI-MS4-BT type
- Firmware update via DALI

L-DALI Multi-Sensor

LDALI-MS2-BT / LDALI-MS3-BT / LDALI-MS4-BT

Specifications			
Type	LDALI-MS2-BT	LDALI-MS3-BT	LDALI-MS4-BT
Dimensions (mm)	Total Ø: 104, DIM042 flush-mounted Ø: 60 mounting depth: 30	Total Ø: 68, DIM089 mounting hole Ø: 60 mounting depth: 42	Total Ø: 68, DIM061 mounting hole Ø: 60 mounting depth: 42
Installation	Ceiling mount: <ul style="list-style-type: none"> • Direct installation in false ceilings (spring mount included) • Flush-mounted installation • On-wall (mounting kit LOYMS2-OW must be ordered separately) 	Ceiling mount: <ul style="list-style-type: none"> • Direct installation in false ceilings (spring mount included) 	
Power supply	DALI bus, 6 mA / 10 mA at 16 V DC (Bluetooth disabled/enabled), max. 10mA (inrush current)		
Operating conditions	0 °C to 50 °C, 10 – 90 % RH, noncondensing, degree of protection: IP20		
Interfaces	1 x DALI 1 x infrared remote control receiver 3 x digital input (dry contact, not protected against overvoltage) 1 x Bluetooth interface		
DALI protocol conformance (IEC 62386 parts)	101 ed2, 103 ed1 (input device), 301 ed1 (digital inputs, IR remote), 303 ed1 (PIR), 304 ed1 (lux sensor)		
Bluetooth & RF characteristics	Maximum output power: + 4 dBm Frequency range: 2402 - 2480 Mhz		
Occupancy detection	PIR and acoustic, sensitivity adjustable		
Passive infrared motion detector	Detection diameter: 10.8 m @ 3 m mounting height (92 m ²), 136 zones, opening angle: 122° (up to 5 m mounting height) Highbay-application: 5 m – 12 m mounting height, detection area: 256 m ² (opening angle: 73.6° @ max.12 m, 122° @ 5 m)	Detection diameter: 7.2 m @ 3 m mounting height (44 m ²), 156 zones, opening angle: 100° (up to 5 m mounting height)	
Mounting height	max. 12 m	max. 5 m	
Illuminance measurement	0 – 4000 lux, resolution: 0.125 lux		
Temperature measurement	-5 °C to 60 °C, resolution: 0.1 °C, accuracy: ±0.2 °C (0 °C to 70 °C)		
Rel. Humidity measurement	0 % – 100 %, resolution 0.5 %, accuracy: typ. ±2.2 % R.H. @ 25 °C, 20 % – 80 % R.H. typ. ±4 % R.H. @ 25 °C, 0 % – 20 % R.H. and 80 % – 100 % R.H.		
Connection wires profile	0.2 – 1.5 mm ² [AWG 28 – 14]		
Wire stripping length	6 mm [0.24 in]		
Wire length for digital inputs	< 10 m		
Color	RAL 9010, pure white		
For use with	LDALI-3E10x-U, LDALI-ME20x-U, LDALI-PLCx, LROC-40x, LIOB-591		
Resource limits			
Type	LDALI-MS2-BT	LDALI-MS3-BT	LDALI-MS4-BT
Number of LDALI-MSx-BT	16 per DALI channel, with sufficient dimensioned DALI bus power supply		



LOYMS2-OW, On-wall Mounting Box



LDALI-MS2-BT



LDALI-MS3-BT



LDALI-MS4-BT

LDALI-MS2-BT / LDALI-MS3-BT / LDALI-MS4-BT

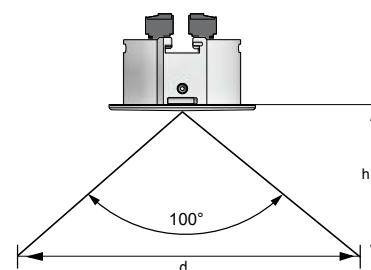
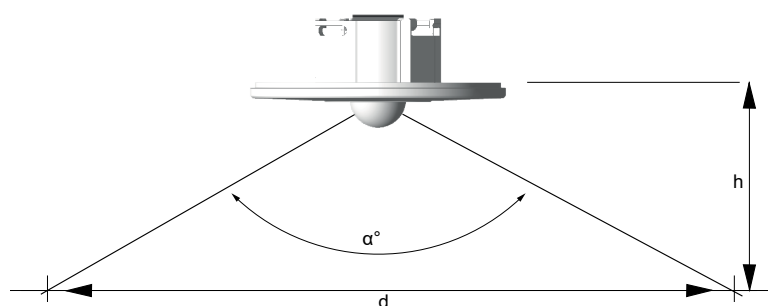

Mounting Height / Coverage LDALI-MS2/MS3-BT

h [m]	d [m]	A [m ²]	α [°]
1.5	5.4	23	122
2.0	7.2	41	122
2.5	9.0	64	122
2.7	9.7	75	122
3.0	10.8	92	122
3.5	12.6	125	122
4.0	14.4	164	122
4.5	16.2	207	122
5.0	18.0	256	122
6.0	18.0	256	112
8.0	18.0	256	96.7
10.0	18.0	256	84
12.0	18.0	256	73.6

Mounting Height / Coverage LDALI-MS4-BT

h [m]	d [m]	A [m ²]	α [°]
1.5	3.6	10.0	100
2.0	4.8	17.8	100
2.5	6.0	27.9	100
2.7	6.4	32.5	100
3.0	7.2	40.2	100
3.5	8.3	54.7	100
4.0	9.5	71.4	100
4.5	10.7	90.3	100
5.0	11.9	111.5	100

Order number	Product description
LDALI-MS2-BT	DALI multi-sensor (presence detection, illuminance sensor, IR receiver, temperature sensor, humidity sensor, 3 digital inputs, Bluetooth), up to 12 m mounting height
LDALI-MS3-BT	DALI multi-sensor (presence detection, illuminance sensor, IR receiver, temperature sensor, humidity sensor, 3 digital inputs, Bluetooth), up to 12 m mounting height
LDALI-MS4-BT	DALI multi-sensor (presence detection, illuminance sensor, IR receiver, temperature sensor, humidity sensor, 3 digital inputs, Bluetooth, flat lense), up to 5 m mounting height
LOYMS2-OW	On-wall Mounting Kit for LDALI-MS2-BT / LOYBT-MS2 (8 pcs per package)
L-RC1	Infrared remote control for room automation applications

LDALI-PD1

Datasheet #89089701



The LDALI-PD1 module enables the control of phase-cut dimmed consumers via a DALI channel. Typical application scenarios are the integration of 230V LED-retrofit-bulbs or halogen lamps in DALI lighting applications.

The device supports a wide voltage range from 220-240 VA C 50/60Hz. The LDALI-PD1 is suitable for loads from 1VA up to 150VA. The load type (RL/RC) is automatically detected and used to select a suitable dimming-method (leading or trailing edge phase-cut). The dimming range is 3%-100%.

The integration of the module in the DALI network follows the same simple steps as the integration of a DALI lamp. The device supports the DALI-specification IEC 62386-205 (Device Type 4, "Incandescent lamp"). The LDALI-PD1 modules are directly connected to a DALI-channel and also supplied with energy by that channel. Thus in case of a system failure the intended state of the output is off.

The LDALI-PD1 is equipped with an open-circuit detection that indicates a lamp failure if no load is connected.

The LDALI-PD1 is designed for installation in distribution boxes or behind standard pins in installation boxes.

Features

- Easy integration into LOYTEC L-DALI lighting system and LROC-40x room automation controllers
- Device configuration with the free LINX Configurator or via the built-in web server of the L-DALI controller
- Dimmable built-in phase-cut dimmer
- Automatic load detection and selection of leading or trailing edge phase-cut dimming
- Suitable for phase-cut dimmed consumers like dimmable retrofit LED and CFL lamps, halogen lamps, ...
- Wide range voltage support (220-240 V AC 50/60Hz)
- Up to 64 LDALI-PD1 modules per DALI channel with sufficient dimensioned bus supply
- Supplied via DALI channel
- Electrically isolated between DALI and mains
- Open circuit detection
- DALI specification IEC 62386-102 and IEC 62386-205 supported
- Firmware update via DALI

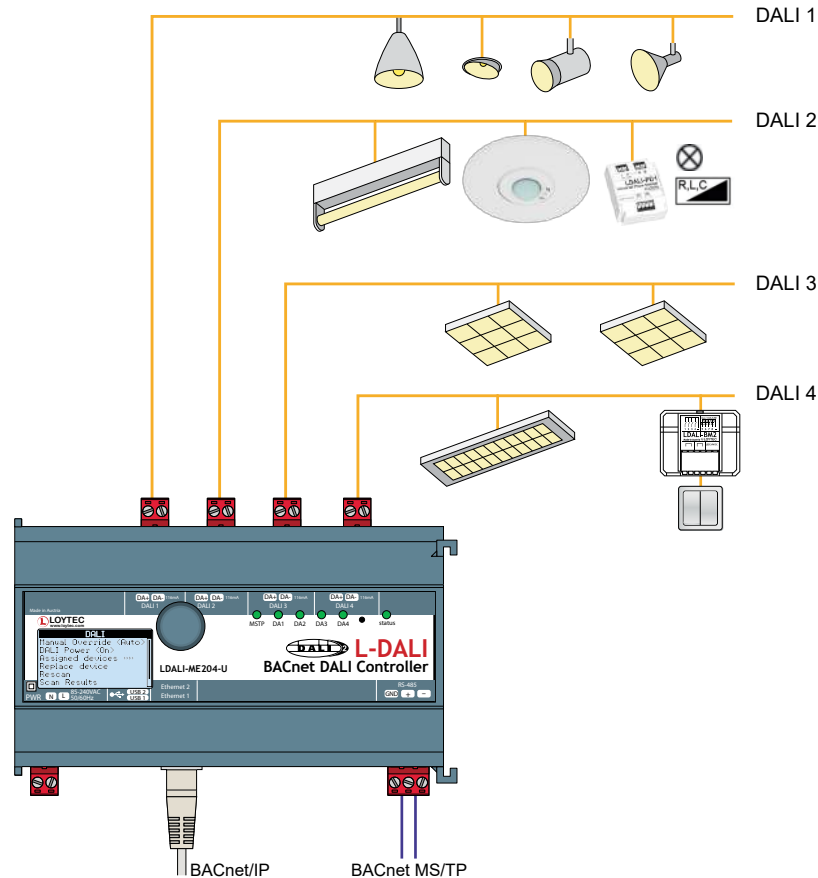

Specifications

Type	LDALI-PD1
Dimensions (mm)	51 x 41 x 21 (L x W x H), DIM044
Power supply	DALI bus, idle 3 mA (@16 V DC), typ. 6 mA (@16 V DC), max. 11mA (inrush current)
Voltage	220-240 V AC, 50/60Hz
Operating conditions	0°C – 50°C, 10 – 90% RH, non-condensing, degree of protection: IP20
Interfaces	1 x DALI, protected against overvoltage (mains)
DALI protocol conformance (IEC 62386 parts)	101 ed2, 102 ed2, 205 ed1
Terminal blocks	Push terminals
Connection wires profile	0.2 – 1.5 mm ² [AWG 24 – 12]
Wire stripping length	8 mm [0.31 in]
Load range	1 VA – 150 VA (RC, RL, RLC)*
Maximum wire length to luminaire	25 m
For use with	LDALI-3E10x, LDALI-ME20x, LDALI-PLCx, LROC-40x, LIOB-591

* Note: LED/CFL lamps up to a rated power of 25W may have a power factor of 0.5 only.

Resource limits

Number of LDALI-PD1 64 per DALI channel, with sufficient dimensioned DALI bus power supply

Order number Product description

LDALI-PD1 DALI phase-cut dimmer module

LDALI-PWM4-x

Datasheet #89075323



The LDALI-PWM4-x is a 4 channel constant voltage LED driver. It is suitable for constant voltage LED modules and LED strips with operating voltages from 12 to 24 V DC.

The module provides a wide dimming range from 0.1% to 100% and adjustable PWM frequency (125/250/500 Hz). The maximum load is limited by 3 A per channel. The module provides overtemperature protection as well as open- and short-circuit protection for each channel.

From a DALI perspective the channels can be controlled independently via separate DALI addresses. The LDALI-PWM4 module is compliant to the DALI-specifications IEC 62386-101, IEC 62386-102 and IEC 62386-207 (Device Type 6, "LED"). Separate module types for tunable white (LDALI-PWM4-TC) and colour control applications (LDALI-PWM4-RGBW) support the DALI specification IEC 62386-209 (Device Type 8, "Colour Control").

Features

- Easy integration into LOYTEC L-DALI lighting systems and LROC-40x room automation controllers
- Device configuration with the free LINX Configurator or via the built-in web server of the L-DALI controller
- Dimmable built-in constant voltage DALI LED driver
- Suitable for constant voltage LED modules and LED strips
- LDALI-PWM4: 4 PWM channels, each of which can be controlled independently via separate DALI addresses
- LDALI-PWM4-TC: 4 PWM channels, 2 of which are controlled via a DALI address (DT8 - Mode Tc), perfectly suited for tunable white luminaires
- LDALI-PWM4-RGBW: 4 PWM channels, controlled via a common DALI address (DT8 - Mode RGBWAF)
- Maximum current of 3 A per channel
- Dimming range from 0.1% – 100%
- Adjustable PWM frequency: 125 / 250 (default) / 500 Hz
- Externally powered, supply voltage 12 to 24V DC according to the operating voltage of the LED modules
- High efficiency and low standby power consumption
- Overtemperature, Open- and Short-circuit protection
- DALI-2 certified, supporting IEC 62386-101, IEC 62386-102, IEC 62386-207 and IEC 62386-209
- Firmware update via DALI

Specifications

Type	LDALI-PWM4-x
Dimensions (mm)	51 x 41 x 21 (L x W x H), DIM072
Power supply	12 - 24V DC +10%
Output voltage	4 x PWM, dimming range: 0.1 – 100%
Output current	max. 3 A / channel
Output frequency	125 Hz / 250 Hz (default) / 500 Hz
Operating conditions	0°C to 50°C, 10-90% RH, non-condensing, degree of protection: IP20
Terminal blocks	Push Terminals
Connection wires profile	0.5 – 1.5 mm ² [AWG 24 - 16]
Wire stripping length	8 mm [0.31 in]
MTBF	440000 h @ 50°C (based on MIL-217F, ground benign)
Interfaces	1 x DALI, protected against overvoltage (mains voltage), current consumption: 2 mA
Number of DALI addresses	1 (LDALI-PWM4-RGBW), 2 (LDALI-PWM4-TC) or 4 (LDALI-PWM4)
DALI protocol conformance (IEC 62386 parts)	101 ed2, 102 ed2, 207 ed1, 209 ed1
Certificates	DALI-2
For use with	LDALI-3E10x-U, LDALI-ME20x-U, LDALI-PLCx, LROC-40x, LIOB-591

Recommendation: For wiring keep the cable lengths between module and power supply as well as between module and LED modules/strips as short as possible (refer to the installation sheet).

Resource limits

Number of LDALI-PWM4-x LDALI-PWM4: up to 16 per channel
 LDALI-PWM4-TC: up to 32 per channel
 LDALI-PWM4-RGBW: up to 64 per channel

Order number	Product description
LDALI-PWM4	PWM module, DALI, 4 x 3 A LED outputs, 24 V DC ext.
LDALI-PWM4-TC	PWM module tunable white, DALI, 4 x 3 A LED outputs, 24 V DC ext.
LDALI-PWM4-RGBW	PWM module RGBW, DALI, 4 x 3 A LED outputs, 24 V DC ext.

LDALI-BM2

Datasheet #89057622



The LDALI-BM2 pushbutton coupler integrates up to four customary light push buttons and switches into a DALI channel. Alternatively, two of the four inputs can be used as analog inputs to connect devices like sliders, dials or even resistance based sensors like NTC temperature sensors.

Connected pushbuttons or switches can be used to control luminaires and sunblinds using L-DALI lighting controllers or L-ROC room automation controllers. The following functions are available:

- Dim up, dim down
- Off
- On with last dimming value
- Scene recall: 1–15
- Dim to a specified value in %
- Color temperature warmer/colder
- Activate auto mode
- Move Sunblind up/down
- Set area Occupied/Unoccupied

In the mode toggle, the function is carried out depending on the lighting status (toggle switch). Communication and power supply is handled via the DALI bus. The LDALI-BM2 is a DALI-2 certified input device as defined in the IEC 62386 2014 standard and can be integrated into DALI-2 systems of other vendors.

Features

- Easy integration into LOYTEC L-DALI lighting systems and LROC-40x room automation controllers
- DALI-2 certified input device as defined in IEC 62386 2014 standard
- 2 digital inputs (dry contact) for conventional pushbuttons or switches
- 2 universal inputs (potential free) for conventional pushbuttons, switches, sliders, dials or NTC temperature sensors
- 4 outputs for direct control of feedback LEDs
- Multi-master compatible, up to 64 LDALI-BM2 pushbutton couplers per DALI channel with sufficient dimensioned bus supply
- Supplied via the DALI channel, no external power supply is necessary
- Pre-confectioned wires for connection of inputs
- Optimized for mounting behind standard switches

Specifications

Dimensions (mm)	45.8 x 37.8 x 13.5 (L x W x H), DIM041
Installation	flush-mounted installation, can be directly installed behind the pushbutton/switch
Power supply	DALI bus, typ. 3 mA at 16 V DC, max. 6 mA (inrush current) Optional 24 V DC ($\pm 10\%$) required to supply feedback LEDs
Operating conditions	0 °C to 50 °C, 10–90 % RH, noncondensing, degree of protection: IP20
Interfaces	1 x DALI, protected against overvoltage (mains voltage) 2 x universal inputs (digital input or resistance measurement, not protected against overvoltage, pluggable), wire length < 10 m (digital), wire length < 50 cm (analog) 2 x digital input (dry contact, not protected against overvoltage, pluggable), wire length < 10 m 4 x outputs for feedback LEDs (3mA max. per LED)
DALI protocol conformance (IEC 62386 parts)	101 ed2, 103 ed1 (input device), 301 ed1 (digital inputs), 302 ed1 (universal inputs)
For use with	LDALI-3E101-U, LDALI-3E102-U, LDALI-3E104-U, LDALI-ME201-U, LDALI-ME204-U, LDALI-PLC4, LROC-40x

Resource limits

Number of LDALI-BM2	64 per DALI channel, with sufficient dimensioned DALI bus power supply
Connection wires profile	0.2 - 1.5 mm ² [AWG 24 - 16]
Wire stripping length	8 mm [0.31 in]
Wire length for digital inputs	< 10 m
Wire length for universal inputs (digital)	< 10 m
Wire length for universal inputs (analog)	< 50 cm

Order number Product description

LDALI-BM2	Quadruple DALI pushbutton coupler
-----------	-----------------------------------

LDALI-RM5, LDALI-RM6

Datasheet #89076925



The LDALI-RM Relay Modules enable the control of consumers without DALI interface. Typical application scenarios are the integration of non-DALI luminaires (with 1 – 10V or no control interface) or other loads like fans in toilets or washrooms and motors for partition walls or screens in DALI lighting applications.

The built-in relay contact can be used for currents of up to 10 A or loads of up to 2.500 VA, respectively. It supports a wide voltage range of 120 – 277 V AC and up to 30 V DC. Zero cross switching technology is used to be able to handle the large in-rush currents typically found in lighting applications. For legacy dimmable ballasts the LDALI-RM modules are also equipped with a 1 – 10 V interface, which can be used together with the relay contact to control these types of loads via DALI.

Together with the LOYTEC DALI controllers or LROC-40x room automation controllers, the LDALI-RM modules act as programmable switching output modules. The integration of the module in the DALI network follows the same simple steps as the integration of a DALI lamp. The device supports the DALI specification IEC 62386-208 (Device Type 7, “switching function”) for non-dimmable loads and the DALI specifications IEC 62386-206 (Device Type 5, “converter”) for loads dimmable via the 1 – 10 V interface, respectively (max. 50 mA current sink). The LDALI-RM modules are directly connected to a DALI channel and also supplied with energy by that channel.

As a unique safety feature the relay state for fault conditions can be configured: In case of a loss of power on the DALI bus, the relay will switch to the position as defined with the DALI configuration register “System Failure Level”.

The LDALI-RM module comes with two housing options: While the LDALI-RM5 is designed for installation in distribution boxes or behind standard plugs in installation boxes, the LDALI-RM6 allows installation on US-style fixtures or junction box ½” knockouts (“spud-mount”).

Features

- Easy integration into LOYTEC L-DALI lighting systems and LROC-40x room automation controllers
- Device configuration with the free L-INX Configurator or via the built-in web server of the L-DALI controller
- Programmable switching output for standard consumers in the power grid
- Universal voltage support (120 – 277 V AC)
- Up to 64 LDALI-RM Relay Modules per DALI channel with sufficient dimensioned bus supply
- Supplied via the DALI channel
- Potential-free, bi-stable relay make contact
- Analog 1 – 10 V Interface for legacy dimming lamps
- DALI-2 certified
- DALI specification IEC 62386-208 (Device Type 7 – Switching Function) supported
- DALI specification IEC 62386-206 (Device Type 5 – Converter) supported
- Selection of the desired device type via operating mode (0x0: Switching Function (default); 0x80: Converter)
- Configurable relay position in case of power loss
- Zero cross switching function
- Firmware update via DALI

L-DALI Relay Module

LDALI-RM5, LDALI-RM6

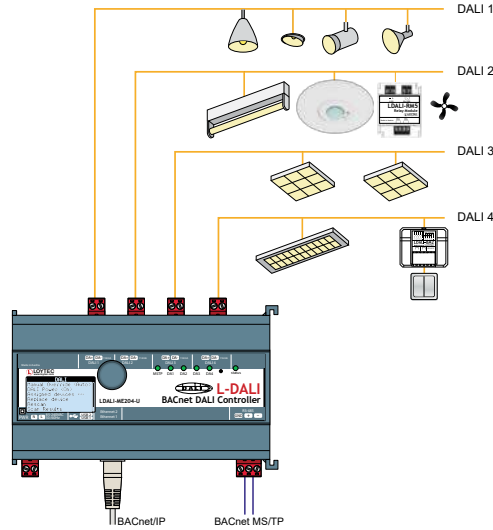

Specifications

Type	LDALI-RM5	LDALI-RM6
Dimensions (mm)	51 x 41 x 21 (L x W x H), DIM066	51 x 51 x 21 (L x W x H), DIM066
Installation	Junction box	Connected to Junction box with knock outs
Purpose of Control	Operating control	
Construction of Control	Independently mounted control	
Feature of automatic action:	Type1	
Rated Impulse Voltage	2500 V	
Overvoltage category	II	
Power supply	DALI bus, idle 3.5 mA / 3 mA (1-10 V connected / not connected) (@16 V DC), typ. 6 mA (@16 V DC), max. 11 mA (inrush current)	
Operating conditions	0 °C to 50 °C, 10 – 90 % RH, non-condensing, degree of protection: IP20	
Interfaces	1 x DALI, protected against overvoltage (mains voltage) 1 x Analog interface 1 – 10 V	
DALI protocol conformance (IEC 62386 parts)	101 ed2, 102 ed2, 208 ed1 (switching) in operating mode 0x0 101 ed2, 102 ed2, 206 ed1 (converter) in operating mode 0x80	
Connection wires profile	0.5 – 1.5 mm ² [AWG 24 – 16]	
Wire stripping length	8 mm [0.31 in]	
Max. switching power	2500 VA @ 250 V AC; 300 W @ 30 V DC	
Nominal switching capacity AC	10 A, 120 V AC (general purpose); 30 000 cycles 10 A, 250 V AC (resistive); 100 000 cycles 10 A, 277 V AC (electronic ballast); 6 000 cycles 8 A, 277 V AC (general purpose); 30 000 cycles	
Nominal switching capacity DC	10 A, 30 V DC	
Relay contact switching voltage	120 – 277 V AC / 30 V DC	
Switching cycle	150000	
Min. switching interval	500 ms	
Max. average switching frequency	20 times/min	
Interface (1 – 10 V)	Current sink max. 50 mA Output voltage range: 0.5 – 10 V	
Certificate	DALI-2, cULus	
For use with	LOYTEC controllers supporting a DALI interface	

Resource limits

Number of LDALI-RM5/LDALI-RM6 64 per DALI channel, with sufficient dimensioned DALI bus power

Order number Product description

LDALI-RM5	DALI Relay Module 10 A, Analog Interface 1 – 10 V
LDALI-RM6	DALI Relay Module 10 A, Analog Interface 1 – 10 V, "spud-mount"

Datasheet #89070424



The LDALI-RM8 Relay Module enables the control of standard loads via DALI. Typical application scenarios are the integration of non-DALI luminaires or other loads like fans in toilets or washrooms, motors for partition walls or screens and fire protection flaps in DALI lighting applications.

The device provides 8 built-in relay contacts, which can be controlled individually via separate DALI addresses as long as the corresponding digital input is open. Closing this input will always switch on the relay (override). Each relay provides a switch that indicates the state and that can be used to switch the relay manually (installation and maintenance). The built-in relay contacts can be used for currents of up to 16 A. They support a wide voltage range of 120 – 277 V AC and up to 30 V DC. The relays are suitable for loads with high inrush currents.

Together with the LOYTEC L-DALI controllers or LROC-40x room automation controllers, the LDALI-RM8 devices act as programmable switching output modules. The integration of the module in the DALI network follows the same simple steps as the integration of DALI lamps. The device supports the DALI specification IEC 62386-208 (Device Type 7, “switching function”) for non-dimmable loads. The LDALI-RM8 is externally powered either by 24 V DC or 85 – 240 V AC.

As a unique safety feature the relay state for fault conditions can be partially configured. In case of a power loss on the DALI bus, the relays will switch to the position as defined with the DALI configuration register “System Failure Level”. In case of a power loss on the 24 V DC / 85 – 240 V AC the relays keep their state until a “Power On” occurs, at which they will switch to the state defined in the “Power On Level” configuration register.

The LDALI-RM8 is intended to be used in a switching cabinet.

The LDALI-RM8 is DALI-2 certified.

Features

- Easy integration into LOYTEC L-DALI lighting systems and LROC-40x room automation controllers
- Device configuration with the free LINX-Configurator or via the built-in web server of the L-DALI controller
- Programmable switching outputs for standard loads in the power grid
- Relay contact switching voltage: 120 – 277 V AC
- Suitable for loads with high inrush currents
- Up to 8 LDALI-RM8 modules per DALI channel
- Supplied via 85 – 240 V AC or 24 V DC $\pm 10\%$
- Potential-free, bi-stable relay make contact
- Relay contacts connectable with different phases
- DALI specification IEC 62386-208 (Device Type 7 – Switching Function) supported
- DALI-2 certified
- Configurable relay positions in case of DALI line outage
- Relays keep their state in case of power loss
- Manual switches on device for indication and manual override
- Digital inputs forcing the corresponding relays to switch on (override, status can be queried)
- Firmware update over DALI

L-DALI Relay Module

LDALI-RM8

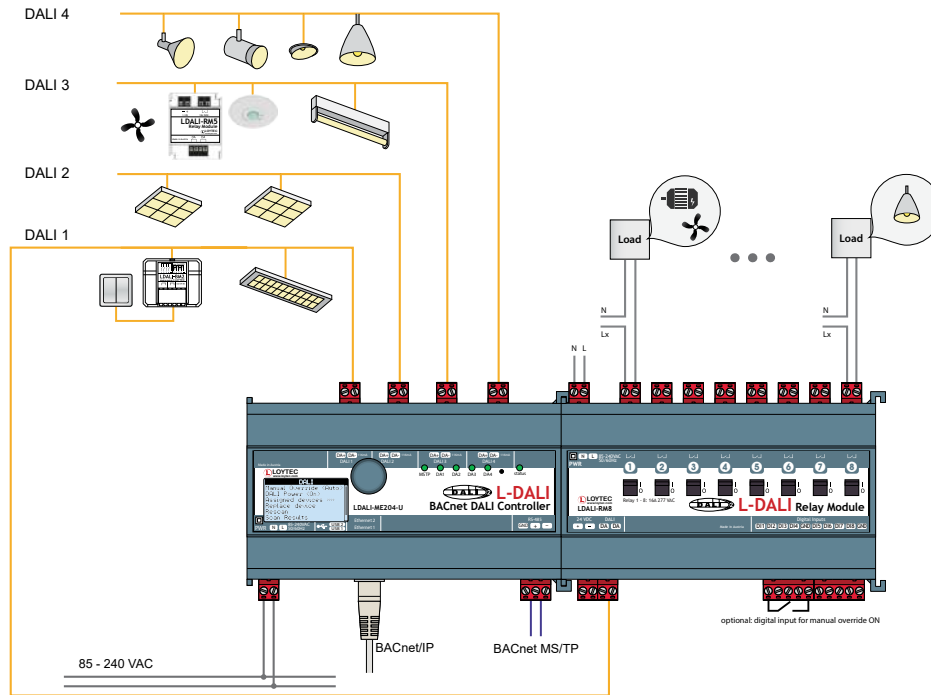

Specifications

Type	LDALI-RM8
Dimensions (mm)	159 x 100 x 75 (L x W x H), DIM064
Installation	DIN rail mounting following Din 43880, top hat rail EN 50022
Purpose of control	Operating control
Construction of control	Independently mounted control
Feature of automatic action	Type 1
Rated Impulse Voltage	2500 V
Overvoltage category	II
Power supply	85 – 240 V AC or 24 V DC $\pm 10\%$, typ. consumption: < 1 W
Operating conditions	0 °C to 40 °C, 10 – 90 % RH, non-condensing, degree of protection: IP40, IP20 (terminals)
Interfaces	1 x DALI, protected against overvoltage (mains voltage), current consumption: 2 mA 8 x digital input (dry contact, not protected against overvoltage)
Number of DALI-addresses	8
DALI protocol conformance (IEC 62386 parts)	101 ed2, 102 ed2, 208 ed1 (switching)
Certificates	DALI-2, cULus
Connection wires profile	0.2 – 2.5 mm ² [AWG 26 – 12]
Nominal switching capacity AC and expected electrical life time	16 A, 277 V AC (resistive, inrush: 480 A); 100 000 cycles (ON:OFF=1s:9s) 16 A, 277 V AC (electronic ballast, inrush: 480 A); 6 000 cycles (ON:OFF=1s:9s) 16 A, 250 V AC (capacitive load 200 μ F, inrush 400 A); 30 000 cycles (ON:OFF=1s:9s)
Nominal switching capacity DC and expected electrical life time	16 A, 30 V DC; 100 000 cycles (ON:OFF=1s:9s)
Relay contact switching voltage	120 - 277 V AC
Min. relay switching interval	500 ms
Minimum delay between switching action on different channels	20 ms
For use with	LDALI-3E101-U, LDALI-3E102-U, LDALI-3E104-U, LDALI-ME201-U, LDALI-ME204-U, LDALI-PLC2, LDALI-PLC4, LROC-40x
Resource limits	
Number of LDALI-RM8	max. 8 per DALI channel
Order number Product description	
LDALI-RM8	DALI Relay Module, 8-channel



The LOY-DALI-SBM1 is a DALI module for controlling sunblinds. The device is bus powered and comes with 2 built-in relay contacts, which are suitable to switch currents of up to 6A at 250 V AC or 30 V DC.

The device provides 2 operating modes:

The Sunblind-Mode (manufacturer specific operating mode 0x80) is well suited for sunblind control due to an extended command set that includes direction and duration information for the blinds connected to the relay outputs. On LOYTEC controllers the device is automatically configured to be used in this mode.

The LOY-DALI-SBM1 is suited to control a single sunblind-motor.

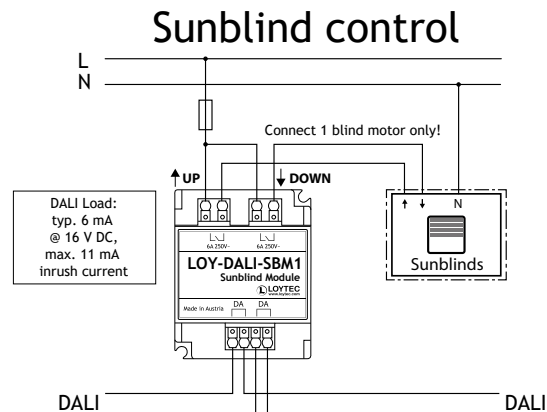

In Relay-Mode (operating mode 0x00) the module acts as DALI-2 certified relay module with 2 interlocked contacts: normally open and normally closed.

Specifications	
Dimensions (mm)	51 x 41 x 21 (L x W x H), DIM085
Installation	Distribution box
Power supply	DALI-bus, idle 3.5 mA (@16 V DC) / typ. 6 mA (@ 16 V DC) / max. 11 mA inrush current
Maximum switching power	1500 VA @ 250 V AC / 180 W @ 30 V DC
Nominal switching capacity	6A @ 250 V AC / 6A @ 30 V DC / inrush currents up to 10A
Relay contact switching voltage	250 V AC / 30 V DC
Switching cycles	150000
Interval times	Relay-Mode (operating mode 0x00): min. switching interval: 200 ms Sunblind-Mode (operating mode 0x80, factory default): min. switching interval: 200 ms switch-on duration: 70 ms - 161840 ms resolution: 10 ms
Operating conditions	0 °C to 50 °C, 10–90 % RH, noncondensing, degree of protection: IP40, IP20 (terminals)
Interfaces	1 x DALI, protected against overvoltage (mains)
Certificates	DALI-2
DALI protocol conformance (IEC 62386 parts)	101 ed2, 102 ed2, 208 ed1 (in operating mode 0x00)
Terminal blocks	Push Terminals
Connection wires profile	0.2 – 1.5 mm ² (AWG 24 - AWG 12)
Wiring stripping length	8 mm [0.31 in]
For use with	LDALI-3E10x-U ¹ , LDALI-ME20x-U ¹ , LDALI-PLCx, LROC-40x, LIOB-591
Resource limits	
Number of LOY-DALI-SBM1	64 per DALI-channel, with sufficient dimensioned DALI bus power supply
Order number	Product description
LOY-DALI-SBM1	DALI Sunblind Module, DALI, 2 x 6A/250 V AC

¹ Not yet available, will be added with a firmware update

Routers, NIC



LIP-1ECTC, LIP-3ECTC, LIP-33ECTC, LIP-3333ECTC

Datasheet #89013122



The L-IP Routers LIP-1ECTC, LIP-3ECTC, LIP-33ECTC, and LIP-3333ECTC connect twisted pair channels (TP/FT-10 or TP/XF-1250) with the Ethernet/IP channel (IP-852) in LonMark Systems. L-IP routes CEA-709 packets through an IP based network such as a LAN (Ethernet), an Intranet, or even the Internet.

In order to provide optimal router configurations, the L-IP is available in four different versions providing either 4 x TP/FT-10, 2 x TP/FT-10, 1 x TP/FT10, or 1 x TP/XF-1250. Every L-IP supports the operating modes "Smart Switch Mode" and "Configured Router Mode".

For an easy integration on the IP side, the L-IP provides a web interface. On L-IP Routers LIP-1ECTC, LIP-3ECTC, LIP-33ECTC, and LIP-3333ECTC the Web interface can also be used via an encrypted HTTPS connection. Through this web interface, the built-in CEA-852 Configuration Server can be switched on and configured. The Configuration Server is thus always available online in the network and no additional software tool is required.

Besides the router functionality, the L-IP Routers provide outstanding capabilities for network diagnostic and analysis. They allow the LPA (LOYTEC Protocol Analyzer) transparent access to the twisted pair channels (TP/FT-10 or TP/XF-1250) on the device via Ethernet/IP – via a local Intranet or the Internet. This allows a fast analysis of data communication and reduces time-consuming troubleshooting. All system registers are available as OPC XML-DA and OPC UA data points.

The L-IP Routers LIP-1ECTC, LIP-3ECTC, LIP-33ECTC, and LIP-3333ECTC are equipped with two Ethernet ports. It can either be configured to use the internal switch to interconnect the two ports or every port is configured to work in a separate IP network.

When the Ethernet ports are configured for two separate IP networks, one port can be connected for instance to a WAN (Wide Area Network) with enabled network security (HTTPS) while the second port can be configured to be connected to an insecure network (building LAN) where the standard building automation protocols are present (e.g. IP-852). These devices also feature firewall functionality of course to isolate particular protocols or services between the ports. The built-in VPN function provides for simple VPN setup and secure access to remote sites. The LTE-800 interface enables wireless access to remote sites through a mobile carrier.

Using the internal switch, a daisy chained line topology of up to 20 devices can be built, which reduces costs for network installation. The IP switch also allows the setup of a redundant Ethernet installation (ring topology), which increases reliability. The redundant Ethernet topology is enabled by the Rapid Spanning Tree Protocol (RSTP), which is supported by most managed switches.

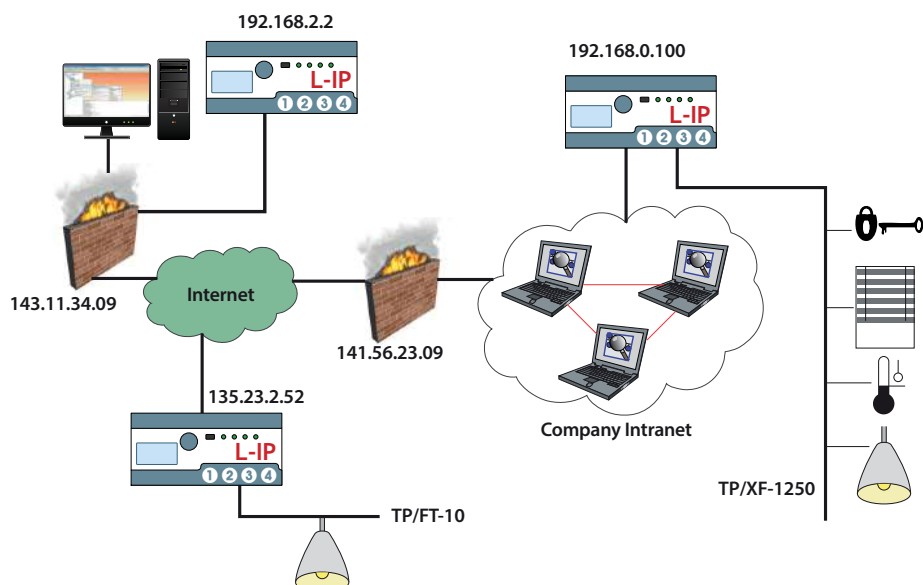
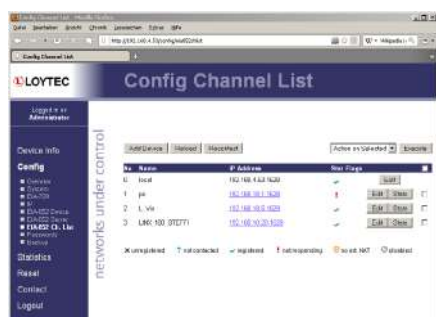





LIP-1ECTC, LIP-3ECTC, LIP-33ECTC, LIP-3333ECTC

Features

- Routes CEA-709 packets between TP/FT-10 (link power compatible) or TP/XF-1250 channels and Ethernet/IP (IP-852)
- Compliant with CEA-709, CEA-852, and ISO/IEC 14908-1 standard (LonMark System)
- Supports Configured Router mode, Smart Switch mode, and Repeater mode
- Built-in CEA-852 configuration server for up to 100 members
- Support for operation behind NAT routers and firewalls
- Easy installation, Auto-NAT, roaming, DHCP
- Remote LPA support with LPA-IP
- Integrated web server for device and IP-852 configuration
- Built-in enhanced communication test for IP-852
- Network diagnostic LEDs
- Dual Ethernet/IP interface
- Secure web interface via HTTPS
- Built-in OPC XML-DA and OPC UA server
- 128x64 graphic display with backlight
- Local display of device information
- Manual operation using the jog dial or VNC client
- Supports WLAN through LWLAN-800 Interface
- Supports LTE through LTE-800 Interface
- Stores user-defined project documentation
- Supports VPN for IP-852

Specifications

Type	LIP-1ECTC	LIP-3ECTC	LIP-33ECTC	LIP-3333ECTC
Dimensions (mm)	107 x 100 x 75 (L x W x H), DIM046			159 x 100 x 75 (L x W x H), DIM054
Installation	DIN rail mounting following DIN 43880, top hat rail EN 50022			
Purpose of control	Operating control			
Construction of control	Independently mounted control			
Feature of automatic action	Type 1			
Operating conditions	0 °C to 50 °C, 10–90 % RH, noncondensing, degree of protection: IP40, IP20 (terminals), pollution degree 2			
Power supply	24 VDC/VAC SELV ±10 %, typ. 3 W			
Rated Impulse Voltage	330 V			
Interfaces	2 x Ethernet (100Base-T): LonMark IP-852, OPC XML-DA (server), OPC UA (server), HTTP, FTP, SSH, HTTPS, Firewall, NTP, VNC, SNMP			
	2 x USB-A: WLAN (needs LWLAN-800), LTE (needs LTE-800)			
	1 x TP/XF-1250	1 x TP/FT-10	2 x TP/FT-10	4 x TP/FT-10
Tools	Configuration via web browser or locally via graphic display and jog dial			
UL Certification				

Resource limits

Configuration Server CEA-852 configuration server for up to 100 members on the IP-852 channel

Order number

Product description

LIP-1ECTC	CEA-709/IP-852 Router, 1 x TP/XF-1250, 1 x Ethernet-Port (IP-852)
LIP-3ECTC	CEA-709/IP-852 Router, 1 x TP/FT-10, 2 x Ethernet port (IP-852)
LIP-33ECTC	CEA-709/IP-852 Router, 2 x TP/FT-10, 2 x Ethernet port (IP-852)
LIP-3333ECTC	CEA-709/IP-852 Router, 4 x TP/FT-10, 1 x Ethernet port (IP-852)
LPOW-2415B	Power supply unit with power connector 24 VDC, 15 W
LWLAN-800	Wireless LAN Interface IEEE 802.11bgn
LT-03	Network terminator, 1 x TP/FT-10 or TP/LPT-10 (bus or free topology), 1 x Network Access Connector RJ45
LT-13	Network terminator, 1 x TP/FT-10 or TP/LPT-10 (bus or free topology), 1 x TP/XF-1250
LT-33	Network terminator, 2 x TP/FT-10 or TP/LPT-10 (bus or free topology)
LTE-800	LTE Interface

BACnet/IP Router

LIP-ME201C, LIP-ME202C, LIP-ME204C

Datasheet #89015523

✓ BACnet
CEA-709
KNX

Modbus
M-Bus
✓ OPC



The LIP-ME201C, LIP-ME202C, and LIP-ME204C BACnet/IP Routers connect BACnet MS/TP channels to a BACnet/IP network. The BACnet routers are compliant with the standards ASHRAE 135-2012 and ISO 16484-5:2012. The routers can be configured to act as a BACnet Broadcast Management Device (BBMD). The L-IP BACnet/IP Routers also provide Foreign Device support and BACnet/SC.

The BACnet router can act as a BACnet Time Master and as a BACnet MS/TP Slave Proxy. Extended features like the optional write protection of the BDT, a BACnet/IP Access Control List (ACL), and a simple communications test for BBMD help to locate issues on the network. The BACnet router also features remote MS/TP data packet capturing. BACnet MS/TP data packets are captured by the device and can be analyzed using Wireshark (free Protocol Analyzer, www.wireshark.org). Wireshark can either connect to the L-IP online or the capture file is loaded from the L-IPs web server and analyzed offline in Wireshark.

The entire device configuration of the BACnet router is done via the built-in web server, optionally also secured via HTTPS protocol. All system registers are available as OPC XML-DA and OPC UA data points.

The BACnet router is BTL certified as BACnet Building Controllers (B-BC).

Each L-IP BACnet/IP Router is equipped with two Ethernet ports. It can either be configured to use the internal switch to interconnect the two ports or every port is configured to work in a separate IP network.



When the Ethernet ports are configured for two separate IP networks, one port can be connected for instance to a WAN (Wide Area Network) with enabled network security (HTTPS) and BACnet/SC while the second port can be configured to be connected to an insecure network (LAN) where the standard building automation protocols like BACnet/IP are present. These devices also feature firewall functionality of course to isolate particular protocols or services between the ports. The built-in VPN function provides for simple VPN setup and secure access to remote sites. The LTE-800 interface enables wireless access to remote sites through a mobile carrier.

Using the internal switch, a daisy chained line topology of up to 20 devices can be built, which reduces costs for network installation. The IP switch also allows the setup of a redundant Ethernet installation (ring topology), which increases reliability. The redundant Ethernet topology is enabled by the Rapid Spanning Tree Protocol (RSTP), which is supported by most managed switches.

Features

- Routes packets between BACnet MS/TP and BACnet/IP, BACnet/SC
- Compliant with ANSI/ASHRAE 135-2012 and ISO 16484-5:2012 standard
- BBMD (BACnet Broadcast Management Device)
- Foreign device support
- Slave Proxy for up to 32 MS/TP slave devices
- Configuration via built-in web server
- Built-in OPC XML-DA and OPC UA server
- Dual Ethernet/IP interface
- Access to network statistics via web browser
- BACnet MS/TP diagnostic LED
- BACnet MS/TP diagnostic via web interface
- MS/TP remote data packet capture (Wireshark)
- Ethernet link and activity LED
- Secure web interface via HTTPS
- 128x64 graphic display with backlight
- Local display of device information
- Manual operation using the jog dial or VNC client
- Supports WLAN through LWLAN-800 Interface
- Supports LTE through LTE-800 Interface
- Stores user-defined project documentation
- Supports VPN for BACnet/IP

LIP-ME201C, LIP-ME202C, LIP-ME204C

Specifications			
Type	LIP-ME201C	LIP-ME202C	LIP-ME204C
Dimensions (mm)	107 x 100 x 75 (L x W x H), DIM046		159 x 100 x 75 (L x W x H), DIM054
Installation	DIN rail mounting following DIN 43880, top hat rail EN 50022		
Purpose of control	Operating control		
Construction of control	Independently mounted control		
Feature of automatic action	Type 1		
Operating conditions	0 °C to 50 °C, 10–90 % RH, noncondensing, degree of protection: IP40, IP20 (terminals), pollution degree 2		
Power supply	24 VDC/ VAC SELV ±10 %, typ. 2.5 W		
Rated Impulse Voltage	330 V		
Interfaces	2 x Ethernet (100Base-T): BACnet/IP, BACnet/SC, OPC XML-DA (server), OPC UA (server), HTTP, FTP, SSH, HTTPS, Firewall, NTP, VNC, SNMP		
	2 x USB-A: WLAN (needs LWLAN-800), LTE (needs LTE-800)		
	1 x BACnet MS/TP	2 x BACnet MS/TP	4 x BACnet MS/TP
Tools	Configuration via web browser or locally via graphic display and jog dial		
UL Certification			

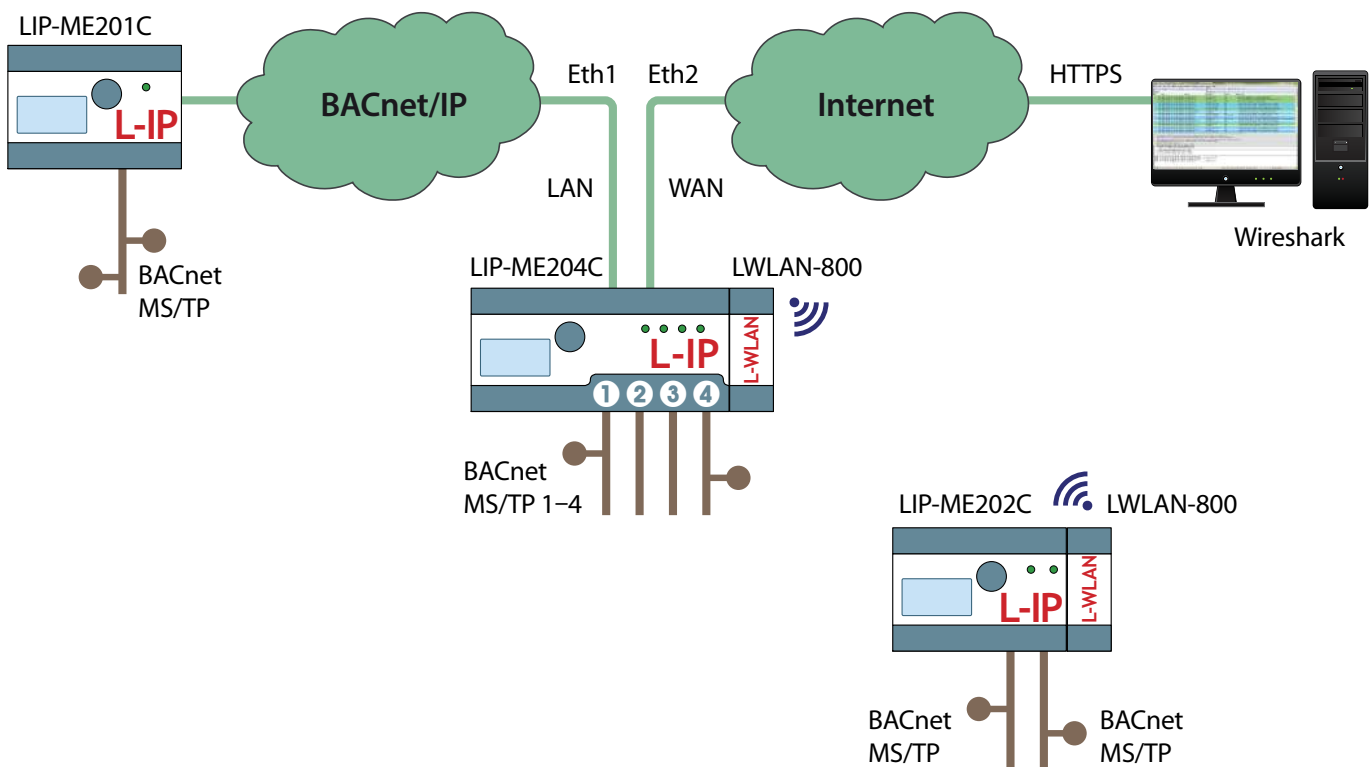

BACnet/IP Router

LIP-ME201C, LIP-ME202C, LIP-ME204C

Order number	Product description
LIP-ME201C	BACnet/IP Router, 1 x BACnet MS/TP (RS-485), 2 x Ethernet port (BACnet/IP)
LIP-ME202C	BACnet/IP Router, 2 x BACnet MS/TP (RS-485), 2 x Ethernet port (BACnet/IP)
LIP-ME204C	BACnet/IP Router, 4 x BACnet MS/TP (RS-485), 2 x Ethernet port (BACnet/IP)
LPOW-2415B	Power supply unit with power connector 24 VDC, 15 W
LWLAN-800	Wireless LAN Interface IEEE 802.11bgn
LT-04	Network terminator, 1 x RS-485 (bus topology, ANSI TIA/EIA-485), 1 x Network Access Connector RJ45
LT-B4	Network terminator, 1 x RS-485 (bus topology, ANSI TIA/EIA-485) with biasing circuit (failsafe biasing)
LTE-800	LTE Interface

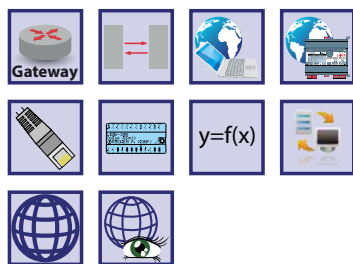

LOYTEC NICs are the most universal network interfaces for CEA-709 and IP-852 (Ethernet/IP) channels. Based on LOYTEC's Core Technologies, they offer high packet rates and short response times. All NICs are fully compatible with products like NL220, ALEX, LonMaker®, and other LNS® applications. The NICs are also compatible with NodeUtil32, NLUtil, OPC servers, and high performance ORION applications.

The multiplexed network interface (MNI) support allows starting multiple LNS® or MIP applications to run in parallel with an LPA on a single network interface.

The built-in VPN function provides for simple VPN setup and secure access to remote sites. The LTE-800 interface enables wireless access to remote sites through a mobile carrier.

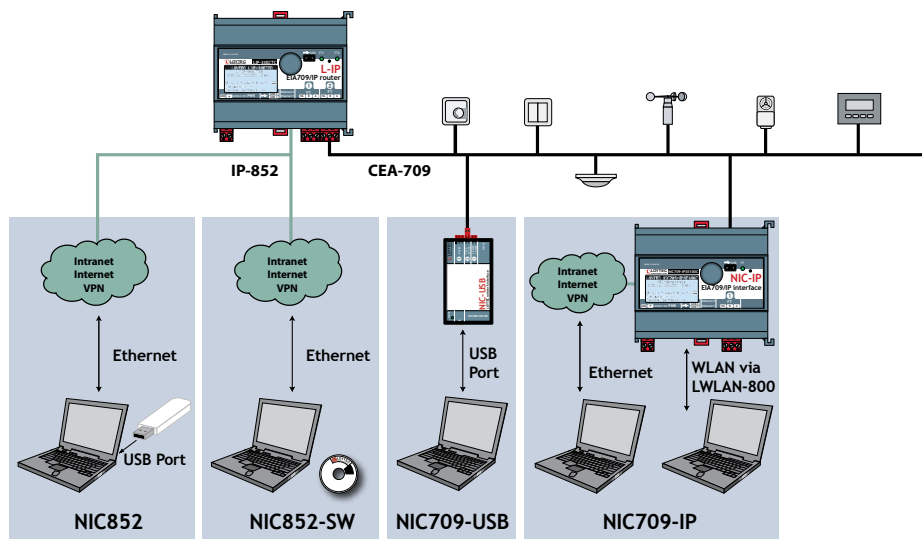

Features

- Network interface for TP/FT-10, TP/XF-1250, RS485, and Ethernet/IP (IP-852) channels
- Available for USB and Ethernet port
- Create up to eight network nodes with a single network interface (MNI devices)
- Use the LPA, LSD Tool, your ORION applications, MIP applications, and LNS® (VNI) applications on a single network interface at the same time
- Compatible with BMS e.g. Honeywell EBI, TAC VISTA, etc.
- Compatible with LNS® applications in high performance VNI™ mode e.g. NL220, NLFacilities, NLOPC-VNI, ALEX, LonMaker®, etc.
- Compatible with MIP applications (LDV interface) e.g. NodeUtil32, NLUtil, NLOPC-MIP, Honeywell CARE 5/7, etc.
- Compatible with high performance ORION applications (ORION API)
- NIC852 is fully compatible with L-IP and i.LON® 600 Internet routers
- Use legacy MIP applications together with the IP-852 (Ethernet) channel
- With dual Ethernet, switched or separated (only NIC709-IP3E100C, NIC709-IP1E100C)
- Supports WLAN with LWLAN-800 Interface (only NIC709-IP3E100C, NIC709-IP1E100C)
- Supports LTE with LTE-800 Interface (only NIC709-IP3E100C, NIC709-IP1E100C)
- Runs on Windows 10, Windows Server 2012, Windows Server 2016, Windows Server 2019

NIC Network Interface

NIC709-IP3E100C, NIC709-IP1E100C, NIC709-USB100, NIC852-SW, NIC852

Specifications NIC709-USB100

Type	NIC709-USB100
Dimensions (mm)	120 x 70 x 23 (L x W x H), DIM052
Power supply	Via USB, max. 130 mA
Operating conditions	0 °C to 50 °C, 10 – 90 % RH, noncondensing, degree of protection: IP40, IP20 (terminals)
Interfaces	1 x TP/FT-10 1 x TP/XF-1250 1 x RS-485 (ANSI TIA/EIA-485)
Tools	LOYTEC Network Interface NIC software
Operating system	Windows 10, Windows Server 2012, Windows Server 2016, Windows Server 2019

Resource limits

MNI devices	8 (multiplexed network interfaces)
-------------	------------------------------------

Specifications NIC709-IP3E100C (successor of NIC709-IP3E100) and NIC709-IP1E100C (successor of NIC709-IP1E100)

Type	NIC709-IP3E100C	NIC709-IP1E100C
Dimensions (mm)	107 x 100 x 75 (L x W x H), DIM046	
Installation	DIN rail mounting following DIN 43880, top hat rail EN 50022	
Power supply	12-35 VDC / 12-24 V AC ±10 %, typ. 2.5 W	
Operating conditions	0 °C to 50 °C, 10 – 90 % RH, noncondensing, degree of protection: IP40, IP20 (terminals)	
Interfaces	2 x Ethernet (100Base-T): HTTP, FTP, SSH, HTTPS, Firewall, NTP, VNC, SNMP 2 x USB-A: WLAN (needs LWLAN-800) LTE (needs LTE-800)	
	1 x TP/FT-10	1 x TP/XF-1250
Tools	LOYTEC Network Interface NIC Software	
Operating system	Windows 10, Windows Server 2012, Windows Server 2016, Windows Server 2019	

Resource limits

MNI devices	8 (multiplexed network interfaces)
-------------	------------------------------------

Specifications NIC852

Power supply	Via USB, max. 50 mA
Interfaces	1 x USB PC connector
Tools	LOYTEC Network Interface NIC software
Operating system	Windows 10, Windows Server 2012, Windows Server 2016, Windows Server 2019

Resource limits

MNI devices	8 (multiplexed network interfaces)
-------------	------------------------------------

Order number	Product description
NIC709-USB100	USB interface, connects to the USB port of a PC, supports LonMark TP/FT-10, TP/XF-1250, TP/RS-485 channels
NIC709-IP3E100C	Remote network interface (RNI), PC connection via Ethernet or WLAN, for a LonMark TP/FT-10 channel
NIC709-IP1E100C	Remote network interface (RNI), PC connection via Ethernet or WLAN, for a LonMark TP/XF-1250 channel
NIC852	Floating license via USB hardlock key, uses Ethernet port of PC to connect to LonMark IP-852 channel
NIC852-SW	Software license for one PC, uses Ethernet port of PC to connect to LonMark IP-852 channel
LPOW-2415B	Power supply unit with power connector 24 VDC, 15 W
LWLAN-800	Wireless LAN Interface IEEE 802.11bgn
LT-03	Network terminator, 1 x TP/FT-10 or TP/LPT-10 (bus or free topology), 1 x Network Access Connector RJ45
LT-13	Network terminator, 1 x TP/FT-10 or TP/LPT-10 (bus or free topology), 1 x TP/XF-1250
LT-33	Network terminator, 2 x TP/FT-10 or TP/LPT-10 (bus or free topology)
LTE-800	LTE Interface

LPA-SET-USB, LPA-USB, LPA-IP, LPA-SW, LPA-IP-SW

Datasheet #89010522



The LOYTEC Protocol Analyzer (LPA) for LonMark Systems captures all data packets on CEA-709 or IP-852 networks and displays all recorded packets on a PC screen. The LPA software provides a comprehensive set of functions and methods to view, filter, and analyze data packets down to bit level.

The long time recording capability helps to find even intermittent faults on the network. When the system is configured by an LNS based tool, the LPA software can browse the database in order to display the node and network variable names. Together with all LOYTEC devices featuring a Remote Network Interface (RNI), the LPA software can record packets even from remote twisted-pair channels.

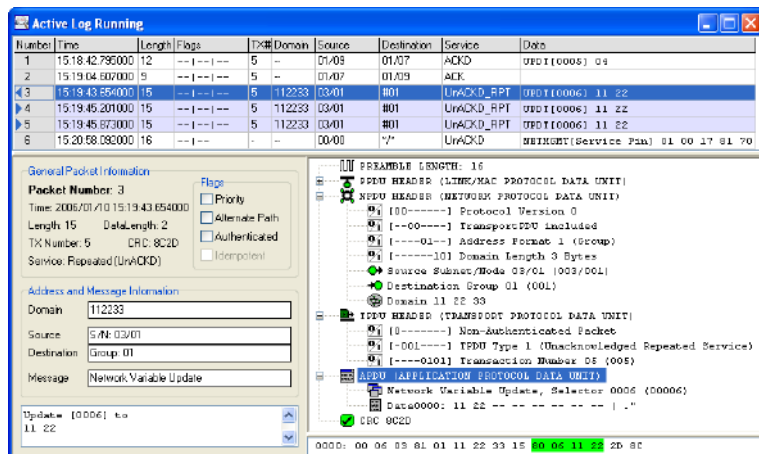

With a single mouse-click, the built-in report function creates reports (text files) showing the health condition of the investigated channel and gives hints and tips on how to solve problems on this channel.

The intuitive and easy-to-use LPA software runs on all LOYTEC network interfaces. On the NIC852 network interfaces, it supports the remote LPA functionality. Each LPA-SW license must be registered for one LOYTEC NIC.

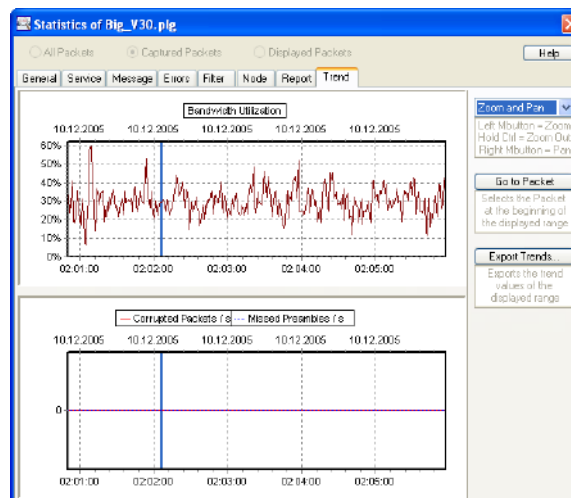

Functions
L-WEB, L-STUDIO
L-ROC
L-LINX
L-IOB
Gateways
L-PAD-7,
L-VIS, L-STAT
L-DALI
Routers, NIC
Interfaces
Accessories

LPA – CEA-709 Protocol Analyzer

LPA-SET-USB, LPA-USB, LPA-IP, LPA-SW, LPA-IP-SW

Features

- Online CEA-709.1 packet monitoring in LonMark Systems
- Packet interpretation down to bit-level
- High resolution packet time-stamping
- Advanced, context specific packet filter and converter manipulation
- Conversion of network addresses and variables into symbolic names
- Advanced Transaction Identification
- Integrated Node Statistics for all detected domains, subnets, nodes, and groups
- Extensive packet statistics (short packets, CRC errors, packets/s, etc.)
- Statistic report function including hints and tips for solving network problems
- Statistic report plug-in interface for localization or customization of the statistic report
- Trend Logging for bandwidth utilization and packet errors
- LNS® database interpretation
- Interpretation of SNVTs, network management, and diagnostic messages
- Displays SNVTs in ISO and Imperial US system
- Long-term packet recording capability and error tracking in packets with protocol errors
- Remote LPA function (needs LPA-IP, LPA-SET-USB or LPA-IP-SW plus NIC852) with L-IP, NIC709-IP, LVIS-3E100, LVIS-3ME7-Gx, LVIS-3ME12-Ax, LVIS-3ME15-Ax, LVIS-3ME15-Gx, LINX-10x, LINX-11x, LINX-12x, LINX-15x, LROC-10x, LGATE-902, LGATE-95x

Specifications

LPA-SW for use with	NIC709-USB100, NIC709-IP3E100C, NIC709-IP1E100C
LPA-IP-SW for use with	NIC852, NIC852-SW
Operating system	Windows 7, Windows 8, Windows 10, Windows Server 2003 (32-bit), Windows Server 2008, Windows Server 2012, Windows Server 2016, Windows Server 2019

Order number Product description

LPA-SET-USB	Set contains: Network Interface NIC709-USB100 and NIC852 Protocol Analyzer Software LPA-IP-SW for IP-852 channels, supports remote LPA, registered to NIC852 Protocol Analyzer Software LPA-SW for CEA-709 channels, registered to NIC709-USB100
LPA-USB	Set contains: Network Interface NIC709-USB100 LPA-SW Protocol Analyzer Software for CEA-709 channels, registered to NIC709-USB100
LPA-IP	IP-852 Channel Protocol Analyzer bundle contains: Network Interface NIC852 Protocol Analyzer Software LPA-IP-SW for IP-852 channels, supports remote LPA, registered to NIC852
LPA-SW	Protocol Analyzer Software, supports all NIC709 network interfaces, NIC709 not included
LPA-IP-SW	Protocol Analyzer Software for IP-852 channels, supports Remote LPA functionality, NIC852 not included

Interfaces



Datasheet #89027523



The L-MBUS level converters are used to connect an M-Bus network to a LOYTEC device. Up to 20 or 80 M-Bus devices can be connected via L-MBUS20 or L-MBUS80.

TTL Connection

The TTL port is used to connect the L-MBUS to the EXT port of L-INX Automation Servers, L-ROC Room Controllers, and also to the L-GATE Gateways. The interface is galvanically isolated.

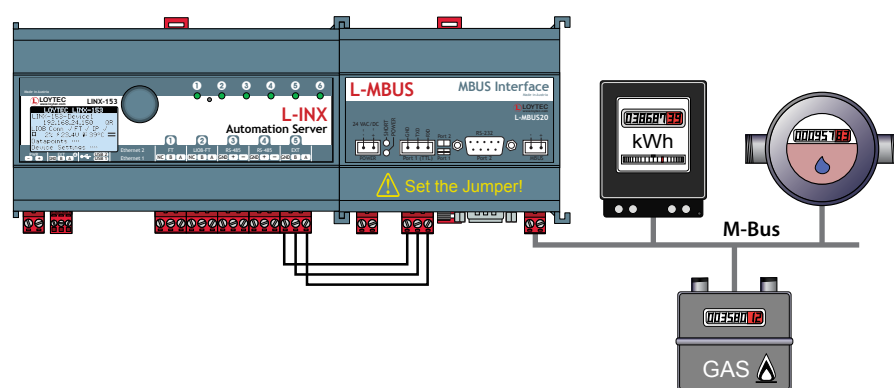

General Specifications

Dimensions (mm)	107 x 100 x 60 (L x W x H), DIM024	
Installation	DIN rail mounting following DIN 43880, top hat rail EN 50022	
Power supply	24 VDC / 24 V AC ±10 %	
Operating conditions	0 °C to 50 °C, 10 – 90 % RH, noncondensing, degree of protection: IP40, IP20 (terminals)	

Specifications

Type	L-MBUS20	L-MBUS80
Power consumption	9.6 W	14.4 W
Baud rate	300 to 9600 baud	300 to 9600 baud
Interfaces	1 x TTL or 1 x RS-232 (EIA-232), galvanically isolated 1 x M-Bus	1 x TTL or 1 x RS-232 (EIA-232), galvanically isolated 1 x M-Bus
For use with	L-INX Automation Servers, L-ROC Room Controllers, L-GATE Gateways, LIOB-586/587/588/589 Controllers	

Resource limits

M-Bus devices	Up to 20	Up to 80
---------------	----------	----------

Order number Product description

L-MBUS20	M-Bus Level Converter, Interface for up to 20 M-Bus devices
L-MBUS80	M-Bus Level Converter, Interface for up to 80 M-Bus devices

Datasheet #89055722



The LMPBUS-804 connects up to four MP-Bus channels with up to 64 MP-Bus slaves to the USB port of the L-INX Automation Server, L-ROC Controller or L-GATE Gateway Controller.

MP-Bus stands for Multi Point Bus. It is the Belimo Master/Slave bus system. The MP-Bus allows to connect up to 8 slaves to a master unit. By exclusively using latest design actuators (e.g. ...MPL) it is possible to connect up to 16 slaves. The advantages of this bus include reduced wiring expenses and substantially higher functionality. Furthermore one sensor can be connected per MP-Bus slave. These sensors include active sensors, passive resistances sensors and switches.

The sensor values can be read over the MP-Bus network.

Features

- MP-Bus Interface for L-INX, L-ROC, and L-GATE Controller
- Configuration through web interface
- 16 devices per channel, up to 4 channels
- Easy device replacement

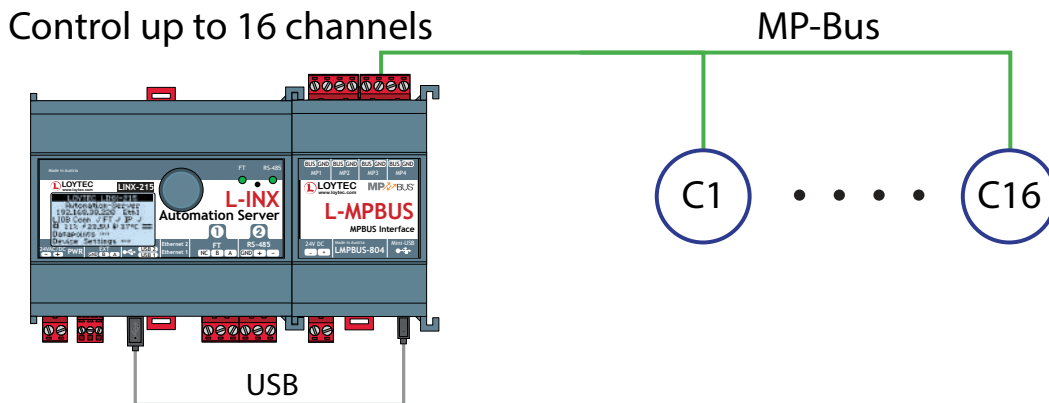

Specifications

Type	LMPBUS-804
Dimensions (mm)	55 x 100 x 60 (L x W x H), DIM051
Installation	DIN rail mounting following DIN 43880, top hat rail EN 50022
Power supply	24 VDC, typ. 2.5 W
Operating conditions	0 °C to 50 °C, 10 – 90 % RH, noncondensing, degree of protection: IP40, IP20 (terminals)
Installation	Connected with a standard USB 2.0 cable, max. 1 m
Interfaces	1 x Mini USB 2.0 Type B 4 x MP-Bus
Tools	Configuration via web interface
For use with	L-INX Automation Servers, L-ROC Room Controllers and L-GATE Gateways
Order number	Product description
LMPBUS-804	MP-Bus interface for 16 devices per channel, up to 4 channels

LKNX-300

Datasheet #89027322



The KNX-Interface LKNX-300 allows the L-INX Automation Servers, the L-ROC Room Controllers, and the L-GATE Universal Gateways to interface to KNX devices connected to a KNX TP1 Bus. The LKNX-300 Interface needs to be connected to the EXT-Port on the L-INX/L-ROC/L-GATE devices.

For the KNX integration, LOYTEC's L-INX/L-ROC/L-GATE devices use an ETS4/ETS5 project. The project data is exported from the ETS4/ETS5 software and then imported in the LOYTEC L-INX Configurator. Thus, up to 250 or 1000 data points from the KNX network can be used by the L-INX/L-ROC/L-GATE devices on each port supporting KNXnet/IP or KNX TP1.



Features

- KNX TP1 Interface for L-INX, L-ROC, and L-GATE
- Access to a maximum of 250 or 1000 KNX data points via KNX TP1 (L-INX/L-ROC/L-GATE)
- Configurable through ETS4/ETS5 software via XML import
- Connected to the L-INX Automation Server, L-ROC Room Controller, or L-GATE Gateway via port EXT

Specifications

Dimensions (mm)	55 x 100 x 60 (L x W x H), DIM028
Installation	DIN rail mounting following DIN 43880, top hat rail EN 50022
Power supply	Via the KNX TP1 bus
Operating conditions	0 °C to 50 °C, 10–90 % RH, noncondensing, degree of protection: IP40, IP20 (terminals)
Installation	Attachable or connected with a 3-wire cable, max. 1 m
Interfaces	1 x EXT 1 x KNX TP1 LIOB-Connect is looped through the device
Baud rate	9600 baud
Tools	L-INX Configurator
For use with	L-INX Automation Servers, L-ROC Room Controllers, L-GATE Universal Gateways

Order number	Product description
LKNX-300	KNX interface to connect KNX TP1 devices

Functions
L-WEB, L-STUDIO
L-ROC
L-INX
L-IOB
Gateways
LPAD-7, L-VIS, L-STAT
L-DALI
Routers, NIC
Interfaces
Accessories

LENO-800, LENO-801, LENO-802

Datasheet #89032523



The L-ENO EnOcean Interface integrates wireless self-powered sensors and micro-energy devices seamlessly into building automation with the use of L-INX Automation Servers, the L-ROC Room Controller, the L-GATE Universal Gateways and the L-DALI Controller. The L-ENO Interface only needs to be connected to the USB port. The L-ENO device is bus-powered over USB and detected automatically.

The L-ENO EnOcean Interfaces are available in three different versions for world-wide use:

- LENO-800 Europe 868 MHz band
- LENO-801 USA/Canada 902 MHz band
- LENO-802 Japan 928 MHz band

Features

- EnOcean Interface for L-INX, L-ROC, L-DALI, and L-GATE
- Supports all common EnOcean Profiles (EEPs) for sensors and actuators
- Configurable through device templates within the L-INX Configurator software
- Web interface for Teach-In, signal strength, and value test
- Easy device replacement
- External antenna included
- Connected to the L-INX Automation Server, L-ROC Room Controller, L-DALI Controller or L-GATE Gateway via USB 2.0
- Support of multi-channel EnOcean devices
- Encrypted wireless connection if the EnOcean device supports this function
- Supports Mailbox function for sleepy actuators (e.g., battery-powered radiator valve)

Specifications

Type	LENO-800	LENO-801	LENO-802
Dimensions (mm)	27 x 89 x 60 (L x W x H) DIM037 , EnOcean antenna DIM040		
Installation	DIN rail mounting following DIN 43880, top hat rail EN 50022 The external antenna has to be installed outside any metallized enclosure.		
Power supply	Via the USB 2.0 bus connection		
Operating conditions	0 °C to 50 °C, 10 – 90 % RH, noncondensing, degree of protection: IP40, IP20 (terminals)		
Installation	Connected with a standard USB 2.0 cable, max. 5 m		
Interfaces	1 x Mini USB 2.0 Type B 1 x EnOcean Wireless Interface conforming to ISO/IEC 14543-3-10 1 x SMA 50 Ohm, EnOcean antenna with 1.5 m connection cable and magnetic base		
Frequency	868.3 MHz	902.875 MHz	928.35 MHz
RF Output Power	3 dBm	1 dBm	0 dBm
Data rate	125 kbit/s		
Tools	L-INX Configurator		
For use with	L-INX Automation Servers, L-ROC Room Controllers, L-DALI Controllers, L-GATE Universal Gateways		

Order number	Product description
LENO-800	EnOcean Interface 868 MHz Europe
LENO-801	EnOcean Interface 902 MHz USA/Canada
LENO-802	EnOcean Interface 928 MHz Japan

L-WLAN Wireless LAN Interface

LWLAN-800

Datasheet #89032822



The L-WLAN Interface expands a LOYTEC device with a wireless LAN connection. The wireless LAN Interface LWLAN-800 can be used with L-INX Automation Servers, L-ROC Room Controllers, L-DALI Controllers, the L-GATE Universal Gateways, L-IP Routers of the series ECTC, NIC709-IP3E100C Remote Network Interfaces, and with most L-VIS Touch Panels. The L-WLAN Interface only needs to be connected to the USB port. Due to the USB bus, the L-WLAN device is energy supplied and detected automatically.

The L-WLAN Interface uses the protocol IEEE 802.11n improvements which significantly increase connection speed, is backward compatible to IEEE 802.11b & IEEE 802.11g, offers a link speed up to 150 Mbps, and an operation frequency/channel:

- USA (FCC) 11 Channels: 2.412 GHz ~ 2.462 GHz
- Europe (ETSI) 13 Channels: 2.412 GHz ~ 2.472 GHz
- Japan 13 Channels: 2.412 GHz ~ 2.472 GHz

After attaching an LWLAN-800 Interface to the USB port of the corresponding LOYTEC device, it is possible to connect it to an existing WLAN Access Point, create a WLAN Access Point, or build up a Mesh network (IEEE 802.11s). The relatively new and emerging standard for Mesh networks offers numerous advantages. A major benefit of a Mesh network is its autonomy. Mesh point configured devices unite autonomously to one network in which Mesh points communicate via other Mesh points. To encrypt a WLAN network the encryption methods WEP, WPA, and WPA2 are available. The Mesh network is encrypted via simultaneous authentication of equals (SAE), comparable to WPA2.

The supplied antennas have a radial gain of up to +2 dBi and have to be mounted outside any metallized housing. To avoid any interferences, please keep a minimum distance of 0.5 m to any electronic devices which also operate with high-frequency signals such as of transformers, ballasts, computers, etc.

Features

- Configuration through web interface
- Increased range through MIMO (multiple-input and multiple-output) – exploiting multipath propagation
- Two external 2.4 GHz antennas included
- Possibility for connecting external antennas via 2 SMA sockets (50 Ω)
- Supports Mesh networking according to IEEE 802.11s
- Supports encryption WEP, WPA, and WPA2

Specifications

Type	LWLAN-800
Dimensions (mm)	27 x 89 x 60 (L x W x H), DIM038, Antenna DIM040
Installation	DIN rail mounting following DIN 43880, top hat rail EN 50022 The WLAN antennas have to be installed outside any metallized housing.
Power supply	Via the USB 2.0 bus connection
Operating conditions	0 °C to 50 °C, 10 – 90 % RH, noncondensing, degree of protection: IP40, IP20 (terminals)
Installation	Connected with a standard USB 2.0 cable, max. 0.5 m
Interfaces	1 x SMA 50 Ohm, RX Antenna 2.4 GHz 1 x SMA 50 Ohm, TX/RX Antenna 2.4 GHz 2 x WLAN antenna magnetic base, cable length = 1 m 1 x USB 2.0 Type B
Frequency	2.4 GHz band
Standard	IEEE 802.11b, IEEE 802.11g, IEEE 802.11n, IEEE 802.11s
RF Output Power	18 dBm (63 mW) ±2 dBm
Tools	Configuration via web interface
For use with	L-INX Automation Servers, L-GATE Gateways, L-ROC Room Controllers, L-DALI Controllers, LVIS-3ME7-Gx, LVIS-3ME12-Ax, LVIS-3ME15-Ax, LVIS-3ME15-Gx, LIP-xECTC, NIC709-IP3E100C
Order number	Product description
LWLAN-800	Wireless LAN Interface IEEE 802.11bgn

Datasheet #89066922



The LTE Interface expands a LOYTEC device with a wireless mobile connection in the LTE network of a mobile provider. The LTE-800 Interface can be used with L-INX Automation Servers, L-ROC Room Controllers, L-DALI Controllers, L-IOB I/O Controllers, the L-GATE Universal Gateways, L-IP Routers of the series ECTC, NIC709-IP3E100C Remote Network Interfaces, and with L-VIS Touch Panels. The LTE Interface simply needs to be connected to the USB port. Power to the LTE Interface is supplied through the 24 VDC power connector.

The integrated LTE module uses the communication standard for LTE, UMTS/HSPA+ and GSM/GPRS/EDGE. It is approved for:

- Carrier Certification: Deutsche Telekom/Verizon/AT&T/Sprint/U.S. Cellular/Telus/T-Mobile/Rogers*
- Regulatory Certification: SRRC/NAL/CCC/GCF/CE/FCC/PTCRB/IC/Anatel/IFETEL/KC/NCC/JATE/TELEC/RCM/NBTC/ICASA/IMDA
- Others: WHQL

After attaching an LTE-800 Interface to the USB port of the corresponding LOYTEC device, the LOYTEC device retrieves its IP configuration from the LTE provider. Together with the built-in VPN function, the LOYTEC device connects and can be accessed via the OpenVPN network technology. This ensures a secure communication path through the LTE network. All networking services of the LOYTEC device are available on the LTE interface and protected by the built-in firewall.

The LTE-800 Interface provides for an easy and simple solution to connect remote sites together via a VPN network and expose defined on-site services. Applications include remote management, energy monitoring, site visualization.

SMS transmission directly from the device is also enabled by the LTE-800 interface. Similar to E-Mails, SMS can contain configurable text and variable placeholders that resolve to data point content at the time of transmission. Together with an alarm data point the LTE-800 can be used as an SMS alarm notifier. The transmission of SMS can be limited to burst and long-term transmission rates.

Features

- Configuration through Web interface
- Easy mobile site integration using VPN technology
- OpenVPN compatible
- SMS transmission and alarm notifier
- Supports LTE standards

Specifications

Type	LTE-800
Dimensions (mm)	55 x 100 x 60 (L x W x H), DIM010, LTE Antenna, DIM060
Installation	DIN rail mounting following DIN 43880, top hat rail EN 50022 The external LTE antenna has to be installed outside any metallized enclosure.
Power supply	24 VDC, typ. 4.5 W
Operating conditions	0 °C to 50 °C, 10 – 90 % RH, noncondensing, degree of protection: IP40, IP20 (terminals)
Installation	Connected with a standard USB 2.0 cable, max. 5 m
Interfaces	1 x Mini USB 2.0 Type B 1 x Micro SIM 2 x SMA LTE Antenna
Standard	LTE, UMTS/HSPA+ and GSM/GPRS/EDGE
Tools	Configuration via web interface
For use with	L-INX Automation Servers, L-GATE Gateways, L-ROC Room Controllers, L-DALI Controllers, LVIS-3MExx-xx, L-IOB I/O Controllers, LIP-xECTC, LIP-ME20x, NIC709-IP3E100C

Order number	Product description
LTE-800	LTE Interface

* Under development

L-SMI Standard Motor Interface

LSMI-800, LSMI-804

Datasheet #89046822



SMI is the acronym for Standard Motor Interface. SMI is a bus protocol used to control SMI sunblind motors for shading. Up to 16 motors can be connected to the bus. The L-SMI interface connects an SMI bus to a L-INX, L-ROC, L-GATE or L-DALI controller. Two SMI interface models are available.

The LSMI-800 connects a single SMI channel with up to 16 SMI motors to the EXT port of the L-INX, L-ROC or L-GATE controller. The bus power for the SMI bus is provided by the LSMI-800 interface but it is not galvanically isolated. Only SMI high voltage motors may be connected to the LSMI-800 interface.

The LSMI-804 connects up to four SMI channels with up to 64 SMI motors to the USB port of the L-INX, L-ROC, L-GATE or L-DALI controller. A galvanically isolated bus power for the SMI bus is provided by the LSMI-804 interface. Hence SMI high voltage or SMI low voltage motors may be connected to the LSMI-804 interfaces but high voltage and low voltage motors must not be mixed on one LSMI-804 interface. In addition to the four SMI bus channels, the LSMI-804 offers four relays controlled by the L-INX, L-ROC, L-GATE or L-DALI controller. Each relay can be used to cut power for the SMI motors on one channel if the motors are standing still. Cutting power when the motors are not moving reduces power consumption for SMI sunblind installations by more than 140 kWh per year for every channel.

Features

- SMI Interface for L-INX, L-ROC, L-GATE and L-DALI Controller
- Configuration through web interface
- Calibration of the blind drives via web interface
- Up to 16 blind drives per SMI port
- Supports Standard Motor Interface, SMI bus systems according to Standard Motor Interface e.V. www.standard-motor-interface.com
- Easy device replacement

Specifications

Type	LSMI-800	LSMI-804
Dimensions (mm)	55 x 100 x 60 (L x W x H), DIM033	107 x 100 x 60 (L x W x H), DIM034
Installation	DIN rail mounting following DIN 43880, top hat rail EN 50022	
Power supply	230 VAC, 50 Hz, max 2 W	85-240 VAC, 50/60 Hz, max 2 W
Operating conditions	0 °C to 50 °C, 10 – 90 % RH, noncondensing, degree of protection: IP40, IP20 (terminals)	
Installation	Connected with a 3-wire cable, max. 1 m	Connected with a standard USB 2.0 cable, max. 1 m
Interfaces	1 x EXT 1 x SMI (Standard Motor Interface)	1 x Mini USB 2.0 Type B 4 x SMI (Standard Motor Interface)
Digital Output (DO)	-	4 x Relay, 10 A
Tools	Configuration via web interface	
For use with	L-INX Automation Servers, L-ROC Room Controllers, L-GATE Gateways and L-DALI Controllers	

Order number Product description

LSMI-800	Standard Motor Interface for 16 motors via EXT port
LSMI-804	Standard Motor Interface for 64 motors, 4 SMI channels via USB

Control up to 16 motors

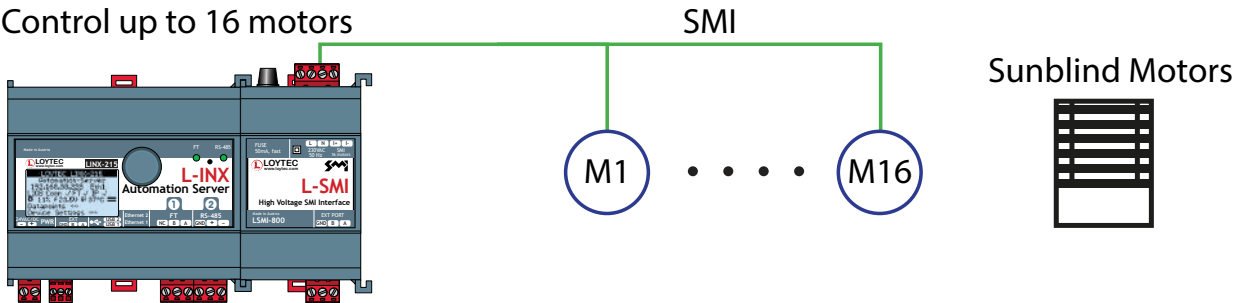

Control up to 64 motors

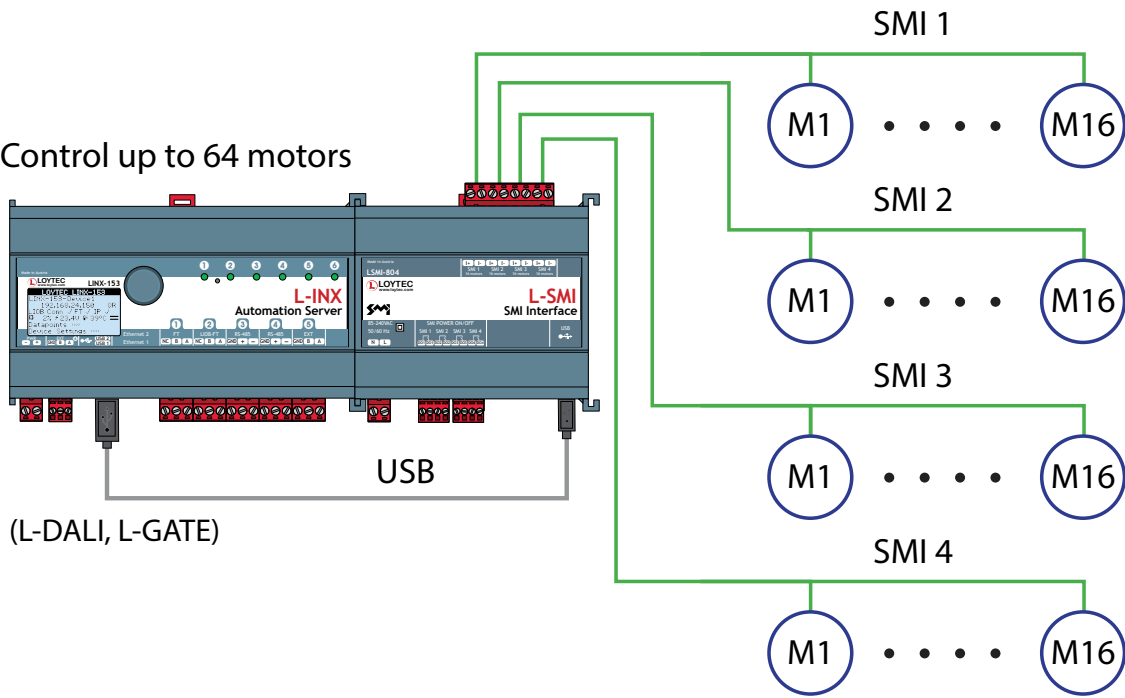

Cut-off power when motor is stopped

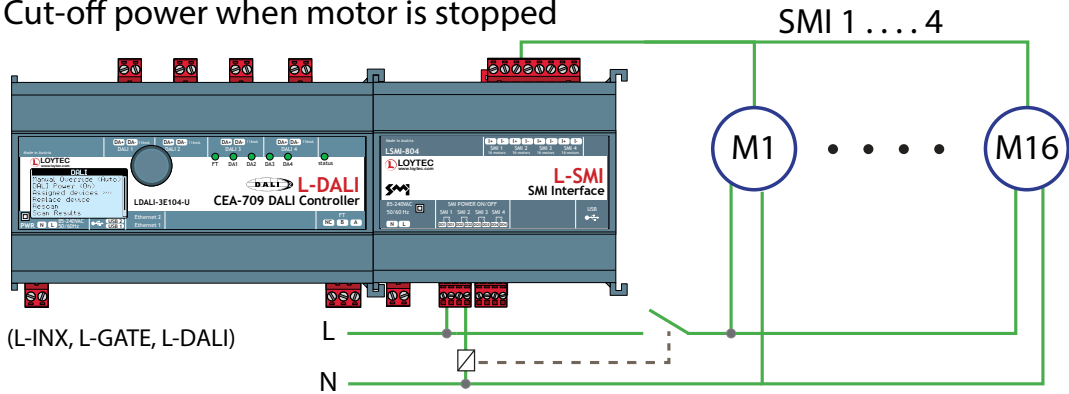

RS-232 Interface

LRS232-802

Datasheet #89078522



The LRS232-802 Interface expands a LOYTEC device by two RS-232 serial ports. It is connected to the USB port of the device and can be configured to run Modbus ASCII or a custom serial protocol implemented by a script module (script requires the L-IOT1 license). The LRS232-802 can be used with compatible L-INX Automation Servers, L-ROC Room Controllers, L-IOB I/O Controllers, L-DALI Controllers, L-GATE Universal Gateways, and with most L-VIS Touch Panels. Due to the USB bus interface, the device does not need a power supply and it is detected automatically.

Features

- Provides two RS-232 ports
- Configuration through web interface and LINX Configurator
- Supports Modbus ASCII over RS-232
- Supports custom serial protocols on RS-232 (L-IOT1 license required)

Specifications

Type	LRS232-802
Dimensions (mm)	27 x 89 x 60 (L x W x H), DIM070
Installation	DIN rail mounting following DIN 43880, top hat rail EN 5002
Power supply	Via the USB 2.0 bus connection
Operating conditions	0 °C to 50 °C, 10 – 90 % RH, noncondensing, degree of protection: IP40, IP20 (terminals)
Installation	Connected with a standard USB 2.0 cable, max. 0.5 m
Interfaces	1 x Mini USB 2.0 Type B 2 x RS-232 ports: Modbus ASCII (Master or Slave) or custom serial protocols (requires L-IOT1 license)
Tools	Configuration via web interface

Order number Product description

LRS232-802	USB to 2 x RS-232 Interface
------------	-----------------------------

A close-up, blue-tinted photograph of a leather shoe sole. A circular patch of a different material is visible on the sole. A metal tool, possibly a scalpel or a small knife, is positioned on the left side of the frame, pointing towards the patch. The background shows the textured leather of the shoe's upper.

Accessories

L-POW Power Supply

LPOW-2415A, LPOW-2415B, LPOW-2460B

Datasheet #89027722



LPOW-2415A

LPOW-2415A is used to supply power to LOYTEC devices with the LOYTEC LIOB-Connect side outlet such as the L-INX Automation Servers, L-ROC Room Controllers, L-GATE Universal Gateways, and LIP-ME204. Additionally, L-IOB I/O Modules and Controllers (except LIOB-585) can be powered by the LPOW-2415A.

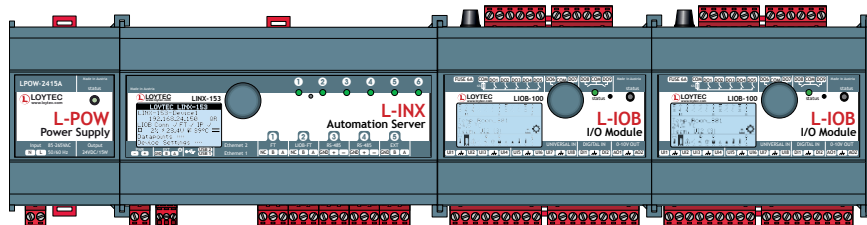

LPOW-2415B

The power supply LPOW-2415B provides 24 VDC via a plug-in screw terminal. It is used to supply power to LOYTEC devices with a separate power terminal of 24 VDC.

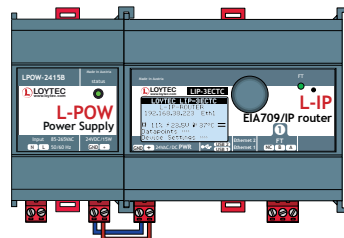

Energy Efficient

The LPOW-2415 are highly efficient switching power supplies. Their efficiency is approximately 80 %. The input voltage range of 85–240 VAC (50–60 Hz) allows worldwide use.

LPOW-2460B

The LPOW-2460B power supply provides 24 VDC and maximum 60 W with screw terminals. It is used to supply power to LOYTEC devices with a separate power terminal of 24 VDC.

LPOW-2415A, LPOW-2415B, LPOW-2460B

Specifications			
Type	LPOW-2415A	LPOW-2415B	LPOW-2460B
Dimensions (mm)	55 x 100 x 60 (L x W x H), DIM025, DIM026		71 x 91 x 55.6 (L x W x H), DIM050
Installation	DIN rail mounting following DIN 43880, top hat rail EN 50022		
Input voltage	85 – 240 V AC, 50 – 60 Hz		100 – 240 V AC, 50 – 60 Hz
Supply voltage	24 VDC 15 W via LIOB-Connect	24 VDC 15 W with plugable screw terminals	24 VDC 60 W with screw terminals
Operating conditions	0 °C to 50 °C, 10 – 90 % RH, noncondensing, degree of protection: IP40, IP20 (terminals)		0 °C to 50 °C, 10 – 90 % RH, noncondensing, degree of protection: IP20 (terminals)
For use with	LIOB-Connect devices for power supply with 24 V DC, max. 15 W (625 mA): L-INX Automation Servers, L-ROC Room Controllers, L-GATE Universal Gateways, LIP-ME204, L-IOB I/O Modules and L-IOB I/O Controllers (except LIOB-585)	Devices for power supply with 24 VDC and max. 15 W (625 mA)	Devices for power supply with 24 VDC and max. 60 W (2.5 A) Maximum 6 devices
Order number	Product description		
LPOW-2415A	LIOB-Connect power supply unit, 24 VDC, 15 W		
LPOW-2415B	Power supply unit with power connector 24 VDC, 15 W		
LPOW-2460B	Power supply unit with power connector 24 VDC, 60 W		



With L-BOX System Distribution Boxes, LOYTEC offers the possibility of a decentralized installation of hardware components, e.g. for the flexible room automation system L-ROC.

For the typical requirements of room automation projects with reoccurring segments, the hardware designed for a certain amount of segments (e.g. 8 or 16 segments, usually I/O modules) can be installed in L-BOX. L-BOX is normally mounted in an intermediate ceiling or double floor. The cabling of the field components in the segment (sun-blind motor, actuators for valves, window contacts etc.) can be connected to the L-BOX in a star topology. In the L-BOX, the cables are strain-relieved and directly wired to the I/O modules.

Specifications LBOX-600

Dimensions (mm)	600 x 250 x 82 (L x W x H), DIM049
Device Installation	485 mm long, top hat rail (35 mm wide) for snap-on mounting of equipment (EN 50022)
Material	Metal, DC01 Sendzimir galvanized

Order number	Product description
LBOX-600	L-BOX System Distribution Box for room automation components, 600 x 250 x 82 (L x W x H in mm)

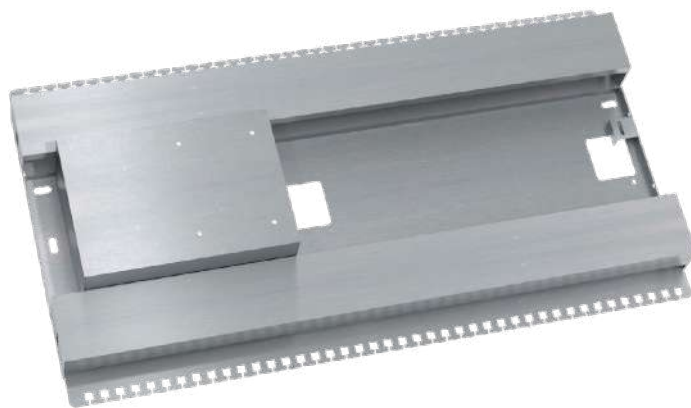

LBOX-ROC1, LBOX-ROC2

The LBOX-ROC1 and the LBOX-ROC2 are designed to ease hardware installation and cabling of LROC-40x room automation projects.

It consists of built-in terminals and strain reliefs, and it is normally mounted in an intermediate ceiling or double floor.

The LBOX-ROC2 has the same features as the LBOX-ROC1, but instead of the 75mm DIN rail it has a built-in 60W 24VDC power supply.

Specifications LBOX-ROC1, LBOX-ROC2

Dimensions (mm)	519 x 280 x 71 (L x W x H), DIM048
Device Installation	suitable for the installation of an LROC-400, LROC-401, or LROC-402 Room Controller
Material	Metal, DC01 Sendzimir galvanized
Input voltage	100 – 240 VAC, 50 – 60 Hz (LBOX-ROC2 only)
Supply voltage	24 VDC 60 W (LBOX-ROC2 only)

Order number	Product description
LBOX-600	L-BOX System Distribution Box for room automation components, 600 x 250 x 82 (L x W x H in mm)
LBOX-ROC1	System Distribution Box for LROC-40x Room Controller, 519 x 280 x 71 (L x W x H in mm)
LBOX-ROC2	System Distribution Box for LROC-40x Room Controller, 60 W 24 VDC power supply

Functions
L-WEB, L-STUDIO
L-ROC
L-INX
L-IOB
Gateways
LPAD-7, L-VIS, L-STAT
L-DALI
Routers, NIC
Interfaces
Accessories



LOYTEC offers several network terminators in DIN rail housing for the LonMark TP/FT-10 and TP/XF-1250 channels.

L-Term LT-03 offers one standard network terminator for a TP/FT-10 or TP/LPT-10 channel supporting bus and free topology. In addition, LT-03 comes with a network access connector (RJ45) for a simple and reliable connection to the CEA-709 network e.g. for maintenance or analyzing the network locally.

L-Term LT-33 offers two standard network terminators for TP/FT-10 or TP/LPT-10 channels in bus and free topology. LT-33 is the perfect solution for LOYTEC network infrastructure products (e.g. L-IP, L-Switch^{XP}, L-Proxy etc.).

L-Term LT-13 combines a terminator for a TP/FT-10 or TP/LPT-10 channel in bus or free topology with a terminator for a TP/XF-1250 channel. LT-13 is the perfect solution to be used together with the LS-13CB, LS-13300CB, or the LS-13333CB L-Switch^{XP}.

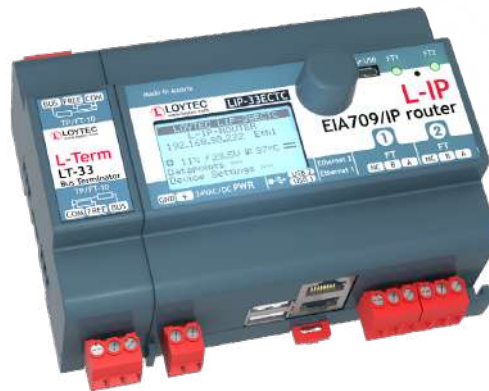

Specifications	
Dimensions (mm)	27 x 89 x 60 (L x W x H), DIM027
Installation	DIN rail mounting following DIN 43880, top hat rail EN 50022
Operating conditions	0 °C to 50 °C, 10–90 % RH, noncondensing, degree of protection: IP40, IP20 (terminals)
Order number	Product description
LT-03	Network terminator, 1 x TP/FT-10 or TP/LPT-10 (bus or free topology), 1 x Network Access Connector RJ45
LT-13	Network terminator, 1 x TP/FT-10 or TP/LPT-10 (bus or free topology), 1 x TP/XF-1250
LT-33	Network terminator, 2 x TP/FT-10 or TP/LPT-10 (bus or free topology)

L-Term Network Terminator

LT-04, LT-B4

Datasheet #89016322

✓ BACnet
 CEA-709
 KNX

✓ Modbus
 M-Bus
 OPC



LOYTEC offers network terminators for RS-485 channels (ANSI TIA/EIA-485) such as BACnet MS/TP, Modbus RTU, or TP/RS485 (CEA-709) in DIN rail housings.

L-Term LT-04 is a terminator for RS-485 channels. In addition, LT-04 comes with a network access connector (RJ45) for a simple and reliable connection to the network e.g. for maintenance or analyzing the network locally.

The LT-B4 is a bus terminator for an RS-485 channel with biasing circuit (failsafe biasing). This biasing circuit draws the level of the bus during standby mode (idle) to a safe value (logic "1"). The LT-B4 needs a power supply of 24 V AC or 24 V DC.



Specifications

Type	LT-04	LT-B4
Power supply	-	24 VDC or 24 VAC ± 10 %
Dimensions (mm)	27 x 89 x 60 (L x W x H), DIM027	
Installation	DIN rail mounting following DIN 43880, top hat rail EN 50022	
Operating conditions	0 °C to 50 °C, 10 – 90 % RH, noncondensing, degree of protection: IP40, IP20 (terminals)	
Termination impedance (Z)	120 Ω	
Order number	Product description	
LT-04	Network terminator, 1 x RS-485 (bus topology, ANSI TIA/EIA-485), 1 x Network Access Connector RJ45	
LT-B4	Network terminator, 1 x RS-485 (bus topology, ANSI TIA/EIA-485) with biasing circuit (failsafe biasing)	

LIOB-A2, LIOB-A4, LIOB-A5

Datasheet #89028322



The LIOB-A2/A4 Adapters can be used to extend the LIOB-Connect bus and to connect an external power supply.

The LIOB-A5 Adapter is a terminator of the LIOB-Connect bus at the end of the last segment. A terminator is needed if the total length of the bus exceeds 1 m.

24 LIOB-Connect I/O Modules can be connected through the LIOB-Connect bus. Up to 4 LIOB-Connect I/O Modules can be plugged directly using the built-in LIOB-Connect plug. If more than 4 modules are to be used, the LIOB-Connect chain must be split into two (or more) segments of modules using LIOB-A2 and 4-wire cables (SEL, GND, A, B), or LIOB-A4 Adapters and standard RJ45 network cables. Each segment needs an external power supply, e.g. LPOW-2415A. This means that with a full configuration of 24 LIOB-Connect I/O Modules, five additional power supplies and 10 LIOB-A2/A4 adapters are required.

If the length exceeds 1 m, either a LIOB-A2 Adapter or a LIOB-A5 adapter must be used at the end of the last segment as a termination. When using the LIOB-A2 adapter as network terminator, the terminal TERM has to be connected with terminal B.

Additionally, the L-IOB Adapters have a power output usable for external devices limited to 100 mA (LIOB-A2) or 400 mA (LIOB-A4/A5).

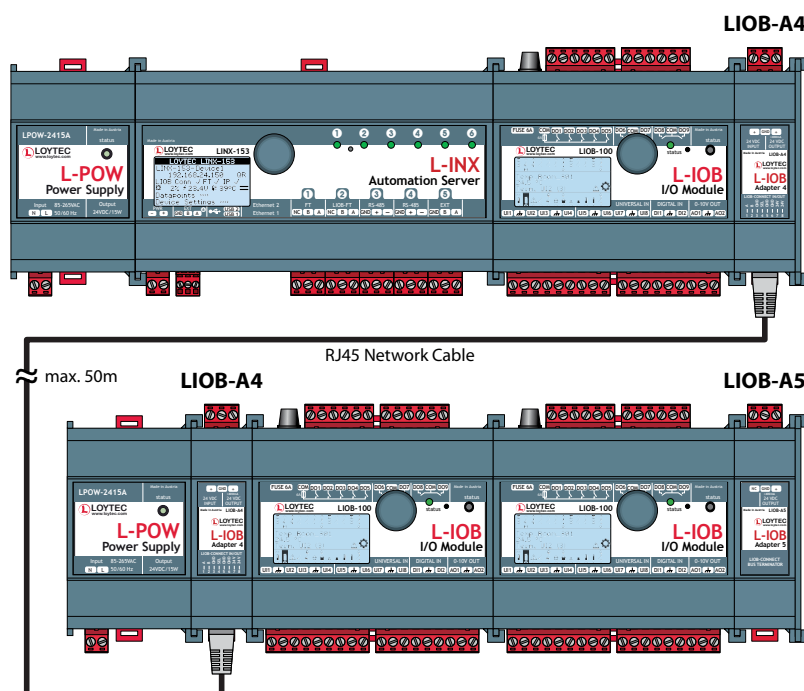

Specifications

Type	LIOB-A2	LIOB-A4	LIOB-A5
Dimensions (mm)	55 x 100 x 60 (L x W x H), DIM029	27 x 100 x 60 (L x W x H), DIM030, DIM031	
Installation	DIN rail mounting following DIN 43880, top hat rail EN 50022		
Input voltage	24 VDC \pm 10 %, either with L-POW Power Supply through LIOB-Connect or with input terminals		-
Output voltage	24 VDC, < 100 mA with pluggable screw terminal	24 VDC, < 400 mA with pluggable screw terminal	
Operating conditions	0 °C to 50 °C, 10 – 90 % RH, noncondensing, degree of protection: IP40, IP20 (terminals)		
For use with	LIOB-Connect Modules (LIOB-10x)		

Order number

Product description

LIOB-A2	L-IOB Adapter 2 to split the LIOB-Connect bus using 4-wire cables
LIOB-A4	L-IOB Adapter 4 to split the LIOB-Connect bus using RJ45 network cables
LIOB-A5	L-IOB Adapter 5 to terminate the LIOB-Connect bus

L-ACT101-MP, L-ACT102-MP

Datasheet #89068222

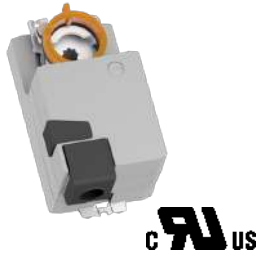

The L-ACT are communicative actuators for adjusting dampers in building installations.

Features

- Air damper size up to approximately 1 m², 10.76 ft²
- Torque motor 5 Nm, 45in-lb
- Nominal voltage AC/DC 24 V
- Communication via Belimo MP-Bus

Specifications

Type	L-ACT101-MP	L-ACT102-MP
Dimensions	116 x 66 x 63 mm, 4.567 x 2.598 x 2.480 inches (L x W x H), DIM008	
Shaft diameter (inches)	5/8"	3/4"
Operating conditions	5 to 95% RH, noncondensing	
Power supply	24 VAC ± 20% 50/60 Hz, 24 VDC ± 10%	
Power consumption in operation	1.5 W	
Power consumption in rest position	1.3 W	
Power consumption for wire sizing	2 VA	
Connection supply / control	Connector Plug	
Parallel operation	Yes (note the performance data)	
Torque motor	5 Nm, 45in-lb	
Communicative control	MP-Bus	
Position accuracy	±5%	
Direction of motion note	ccw rotation	
Manual override	With push-button, can be locked	
Angle of rotation	Max. 95°	
Angle of rotation note	Can be limited on both sides with adjustable mechanical end stops	
Running time motor	90 s / 90°	
Adaption setting range	Manual	
Sound power level, motor	35 dB(A)	
Protection class IEC/EN	III Safety Extra-Low Voltage (SELV)	
Protection class UL	UL Class 2 Supply	
Degree of protection IEC/EN	IP20	
Degree of protection NEMA/UL	NEMA 1	
Enclosure	UL Enclosure Type 1	
EMC	CE according to 2014/30/EU	
Certification IEC/EN	IEC/EN 60730-1 and IEC/EN 60730-2-14	
Certification UL	cURus according to UL60730-1A, UL60730-2-14 and CAN/CSA E60730-1:02	
Mode of operation	Type 1	
Rated impulse voltage supply / control	0.8 kV	
Control pollution degree	3	
Ambient temperature	-30 °C to +50 °C, -22 °F to +122 °F	
Storage temperature	-40 °C to +80 °C, -40 °F to +176 °F	
Order number	Product description	
L-ACT101-MP	Actuator 5/8", 5 Nm, 45in-lb, MP-Bus cable	
L-ACT102-MP	Actuator 3/4", 5 Nm, 45in-lb, MP-Bus cable	

Datasheet #89063123



The LOYDVS-110W02-3SFP Managed 10-Port Ethernet Switch provides many essential features. Its enhanced hardware design, the user-friendly software interface, the packet protection and compatibility with multiple industrial communication standards makes it a highly reliable active network component.

The LOYDVS-110W02-3SFP provides two built-in redundant power supplies and together with its RSTP support it is the perfect fit for building up highly available Ethernet ring topologies for L-INX, L-IOB, and L-ROC controllers.

It features a wide operating temperature range from -40°C to 75°C, and it is UL, CE, and FCC certified.

Features

- IPv6 Network address for larger network and neighbor discovery
- Automatic IP assignment by DHCP/BootP server for easy network construction
- DHCP relay option 82 for sending DHCP requests with clients' identities to a DHCP server
- SNMP v1/v2c/v3 facilitates the exchange of management between network devices
- Support MODBUS TCP protocol that facilitates the remote management by SCADA and other industrial devices
- STP/RSTP/MSTP for network redundancy further ensures reliability
- QoS(IEEE 802.1p) and TOS/DSCP for mission-critical applications
- SNTP (simple network time protocol) for network clock synchronization
- Broadcast/Multicast/Unknown Unicast storm control improves throughput problems
- MAC addresses locking function per port blocks unauthorized access
- USB console interface for easy connection with laptops
- IGMP Snooping and GMVP prunes multicast traffic
- CPU utilization displays the amount of works the CPU handles
- DDM diagnosis function by SFP fiber module
- Auto warning by email, DI, relay, Syslog & SNMP trap
- Compatible with various industrial protocols, EtherNet/IP, Profinet, CC-LINK IE and DNP 3.0

Specifications

Type	LOYDVS-110W02-3SFP
Dimensions (mm)	75 x 108.7 x145.3 (L x W x H), DIM055
Weight (g)	564
Standard Compliance	IEEE 802.3 10Base-T, IEEE 802.3u 100Base-T(X) and 100Base-FX, IEEE 802.3ab 1000Base-T, IEEE 802.3z 1000Base-X, IEEE 802.3x Flow Control, IEEE 802.1D Spanning Tree Protocol, IEEE 802.1w Rapid Spanning Tree Protocol, IEEE 802.1s Multiple Spanning Tree Protocol, IEEE 802.1p Class of Service, Priority Protocols, IEEE 802.1Q VLAN Tagging, IEEE 802.1X Port Authentication, IEEE 802.3ad LACP Aggregation, IEEE 802.1AB Link Layer Discovery Protocol
Processing Type	Store and Forward, IEEE 802.3x Flow control in full duplex
Interface Fast Ethernet	RJ45 Ports: 7 x 10/100Base-T(X), auto MDI/MDI-X, auto negotiation
Combo Ports	3 Ports, either: RJ45 Ports 10/100/1000Base-T, auto MDI/MDI-X, auto negotiation or SFP Ports 100/1000Base-SFP
Alarm Contacts	2 relay outputs Carry current 2 A at 24 VDC
Performance and Scalability	Switching Capacity: 7.4 Gbps
Power Requirements	Input Voltage: 2 sets, 12 to 48 VDC redundant terminal block power input Input Current: max. 0.95A Overload Current Protection, max. input current 3A Reverse Polarity Protection Buffer Time: min. 12ms at 24 VDC
Housing	IP40 aluminum metal case
Installation	Industrial DIN-Rail and wall mounting
Operating conditions	Operating Temperature: -40°C to 75°C (-40 °F to 167 °F) Storage Temperature: -40°C to 85°C (-40 °F to 185 °F) Ambient Relative Humidity: 5% to 95% (non-condensing)
Approvals	Safety: UL 508, EN 60950-1, IEC 61131-2 EMI: FCC 47 CFR Part 15 Subpart B Class A, IEC 61000-6-4, EN 55022 EMS: IEC 61000-6-2

Order number	Product description
LOYDVS-110W02-3SFP	Managed 10-Port Industrial Ethernet Switch

Functions
L-WEB, L-STUDIO
L-ROC
L-INX
L-IOB
Gateways
L-VIS, L-STAT
L-PAD-7,
L-DALI
Routers, NIC
Interfaces
Accessories

Unmanaged Fast Ethernet Switch

LOYDVS-008100

Datasheet #89064123



The LOYDVS-008100 is an unmanaged 8-Port Fast Ethernet Switch with enhanced hardware design, packet protection and compatibility with multiple industrial communication standards. The LOYDVS-008100 features wide operating temperature range from -10°C to 60°C, and it is UL, CE, and FCC certified.

Features

- 12 to 48 VDC terminal block power input
- Compatible with various industrial protocols of EtherNet/IP, Profinet, CC-LINK IE and DNP 3.0

Specifications

Type	LOYDVS-008100
Dimensions (mm)	45 x 108.7 x 145.3 (L x W x H), DIM056
Weight (g)	300
Standard Compliance	IEEE 802.3 10Base-T, IEEE 802.3u 100Base-T(X) and 100Base-FX, IEEE 802.3x Flow Control
Interface	Fast Ethernet Ports, RJ45 Ports: 8 x 10/100Base-T, auto MDI/MDI-X, auto negotiation
Performance and Scalability	Switching Capacity: 1.6Gbps Forwarding Rate: 2.4Mpps MAC Address Table: 8K Packet Buffer Memory: 1M bits
Power Requirements	Input Voltage: 1 set, 12 to 48 VDC terminal block input Input Current: Max. 0.18A Overload Current Protection, max. input current 3A Reverse Polarity Protection Buffer Time: min. 10ms at 24 VDC
Housing	IP40 aluminum metal case
Installation	Industrial DIN-Rail and wall mounting
Operating conditions	-10°C to 60°C, (14 °F to 140 °F) Storage Temperature: -40°C to 85°C, (-40 °F to 185 °F) Ambient Relative Humidity: 5% to 95% (non-condensing)
Approvals	Safety: UL 508, EN 60950-1, IEC 61131-2 EMI: FCC 47 CFR Part 15 Subpart B Class B, IEC 61000-6-4, EN 55022 EMS: IEC 61000-6-2

Order number	Product description
LOYDVS-008100	Unmanaged 8-Port Fast Ethernet Switch

Datasheet #89066223



The LOYDVP16SM11N is an input extension module to be used with the RTU-485.
 The LOYDVP16SM11N is UL, CE, and FCC certified.

Specifications	
Type	LOYDVP16SM11N
Dimensions (mm)	25.2 x 60 x96 (L x W x H), DIM058
Weight (g)	146 g
Power Consumption	2W
Noise immunity	ESD (IEC 61131-2, IEC 61000-4-2): 8KV Air Discharge ESD (IEC 61131-2, IEC 61000-4-2): 8KV Air DischargeEFT (IEC 61131-2, IEC 61000-4-4): Power Line: 2KV, Digital I/O: 1KV, Analog & Communication I/O: 1KV Damped-Oscillatory Wave: Power Line: 1KV, Digital I/O: 1KV RS (IEC 61131-2, IEC 61000-4-3): 26MHz ~ 1GHz, 10V/m
Operation / storage environment	Operation: 0°C ~ 55°C (temperature), 5% ~ 95% (humidity), pollution degree 2 Storage: -25°C ~ 70°C (temperature), 5% ~ 95%(humidity)
I/O Point Specifications	
Input type	DC Type (Sink or Source)
Voltage/Input current	24 V DC 5 mA
Active level	Off - On: more than 16.5 V DC On - Off: less than 8 V DC
Response time	Approx. 10ms
Circuit isolation	By photocoupler
Input display	LED
Order number	Product description
LOYDVP16SM11N	DVP16SM11N I/O Extension Module

Modbus Remote I/O Communication Module

LOYRTU-485

Datasheet # 89065523



The LOYRTU-485 is a Modbus remote I/O communication module to remote-control Slim series DI/DO and AI/AO extension units. The LOYRTU-485 is a standard Modbus slave compatible with LOYTEC devices featuring a Modbus Interface supporting Modbus master mode.

The LOYRTU-485 is UL, CE, and FCC certified.

Features

- Supports Modbus protocol, slave mode
- Connects up to 8 DVP-S series I/O modules
- Max. baudrate: 115.2k bps

Specifications

Type	LOYRTU-485
Dimensions (mm)	25.2 x 60 x96 (L x W x H), DIM059
Weight (g)	160 g
Interface	RS-485
Connector	3-pin, removable
Serial baudrate	1200, 2400, 4800, 9600, 19200, 38400, 57600, 115200 bps
Installation	Industrial DIN-Rail and wall mounting
Power Supply	24 V DC (-15 to 20%)

Order number	Product description
LOYRTU-485	RS-485 Remote I/O Communication Module

Datasheet #89086602



The LOYBT-TEMP1 Bluetooth sensor is a battery powered sensor for measurements of room temperature and relative humidity. It acts as a low-power node in a Bluetooth mesh network and publishes sensor data on change of value as well as periodically.

The device allows to perform measurements at the location of your choice and after adding the sensor to the LPAD-7 the sensor data is automatically mapped to the system registers room temperature and humidity.

Device wake up can be forced by press of the service button. Dependent on the device status the device tries to join a Bluetooth mesh network, find a friend which allows the device to operate as low power node or simply transmits sensor data.

A service button press is always acknowledged by status LED blinking, the LED is also used to indicate power-up and firmware update procedure.

Features

- Easy integration with Bluetooth Mesh enabled LOYTEC devices (e.g. LPAD-7)
- Bluetooth-mesh based sensor, supports low power node feature
- Temperature sensor
- Humidity sensor
- Battery powered, expected battery lifetime: 2 years
- Battery level reporting
- Supports firmware update
- Service Push Button for manual interaction
- LED for optical feedback

Specifications

Dimensions (mm)	30 x 13 (Ø x H), DIM082
Installation	Wall mounted (screw or adhesive tape)
Power supply	Battery powered (CR2032), expected battery life time: 2 years
Operating conditions	0 °C to 50 °C, 10 – 90 % RH, noncondensing, degree of protection: IP20
Interfaces	1x Bluetooth Mesh (low power node) 1x Service Push Button 1x Led (optical feedback)
Bluetooth & RF-characteristics	Maximum output power: +4 dBm Frequency range: 2402-2480 MHz
Temperature Measurement	-5°C to 60°C, resolution 0.1°C, accuracy: ± 0.2° (0°C-70°C)
Relative Humidity Measurement	0%-100%, resolution: 1% Accuracy: typ. ± 2.2% R.H. @25°C, 20%-80% R.H. typ. ± 4% R.H. @25°C, 0%-20% R.H. and 80%-100% R.H.
Sensor Data Update	Periodically: 5 minutes interval Change of Temperature Value: >0.5° since last publication
Bluetooth protocol conformance	Bluetooth 5.1 Declaration ID: D060851 contains qualified designs: 150092 (controller subsystem), 176697 (host subsystem) and 178269 (mesh profile subsystem)
For use with	Bluetooth Mesh enabled LOYTEC devices (e.g. LPAD-7)

Order number

Product description

LOYBT-TEMP1 Bluetooth Mesh temperature sensor (5 pieces per package)

Indoor air quality sensor

LOYUNO-L

Datasheet #89087801

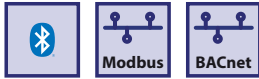

LOYUNO-L represents the pinnacle of indoor air quality monitoring, purposefully designed for effortless integration with BAS/BMS systems. This advanced instrument detects and analyses a wide range of indoor air quality factors, including Ultra-fine, Fine, and Standard Suspended Particulates (PM1, PM2.5, and PM10), Carbon Dioxide (CO₂), Total Volatile Organic Compounds (TVOC), while also monitoring Temperature and Humidity levels.

LOYUNO-L ensures accurate data, serving as a vital component in achieving LEED green or WELL certification for your building. Rigorously tested and certified for its precise sensing capabilities in detecting PM2.5, CO₂, and TVOC, LOYUNO-L meets the stringent standards set by WELL v2.

LOYUNO-L comes equipped with LOYTEC Bluetooth Mesh capabilities, seamlessly integrating with the other Bluetooth Mesh enabled devices. This versatile compatibility makes LOYUNO-L equally well-suited for both new construction projects and retrofitting BAS/BMS systems.

Features

- Multiple IAQ monitors (PM1, PM2.5, PM10, CO₂, TVOC, Temperature, Humidity)
- Supports BACnet MS/TP and Modbus RTU
- Meets Q1 2022, v2 WELL A08 Requirements
- Bluetooth Mesh based sensor
- LEDs for optical air quality feedback and status indication
- Easy integration on Bluetooth Mesh enabled LOYTEC devices (e.g. LPAD-7)
- RESET Grade B Accredited Monitor

Specifications

Type	LOYUNO-L
Dimensions (mm)	141.91 x 42 x 67.91 (L x W x H), DIM083
Installation	Drywall mount, Electrical box mount, wall mount cradle
Power supply	source 1: 12-24 V DC, 24 V AC source 2: power adapter 12V/1A 6W max. (12 V DC)
Measurement	PM1: 0-1000 µg/m ³ ± (5 µg/m ³ + 20%) at 0-100 µg/m ³ ; ± 10% at 100-1000 µg/m ³ , PM2.5: 0-1000 µg/m ³ ± (5 µg/m ³ + 20%) at 0-100 µg/m ³ ; ± 10% at 100-1000 µg/m ³ , PM10: 0-1000 µg/m ³ ± (5 µg/m ³ + 20%) at 0-100 µg/m ³ ; ± 25% at 100-1000 µg/m ³ , CO ₂ : 400-5000 ppm ± (50ppm + 5%), TVOC: 0-30000 ppb ±15% in lab test (Ethanol), Temperature: 0-50°C ±1°C at 25°C and 50% rH, Humidity: 10-80% rH ±10% at 25°C and 50% rH
Sensor Data Update	Periodically 10 seconds (internal refresh rate, no faster than 10 seconds)
Bluetooth & RF-characteristics	Maximum output power: 0 dBm Frequency range: 2402-2480 MHz
Operating conditions	0 °C to 50 °C, 10 – 90 % RH
Interfaces	Modbus RTU / BACnet MS/TP (Select via DIP switch)
Connection	RS-485, Bluetooth 5.1
Bluetooth protocol conformance	Bluetooth 5.1 Declaration ID: D051757
For use with	Bluetooth Mesh enabled LOYTEC devices (e.g. LPAD-7)

Order number	Product description
LOYUNO-L	UNOLite Indoor Air Quality Sensor

Device Dimensions, Certificates



Dimensions of the devices in mm and [inch]

DIM001 L-TEMP2

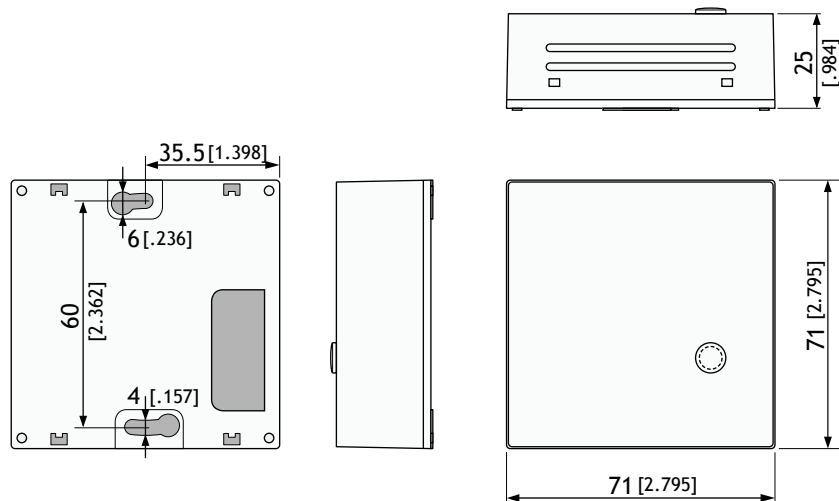

DIM002 LVIS-3ME12-A1

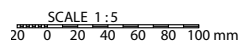
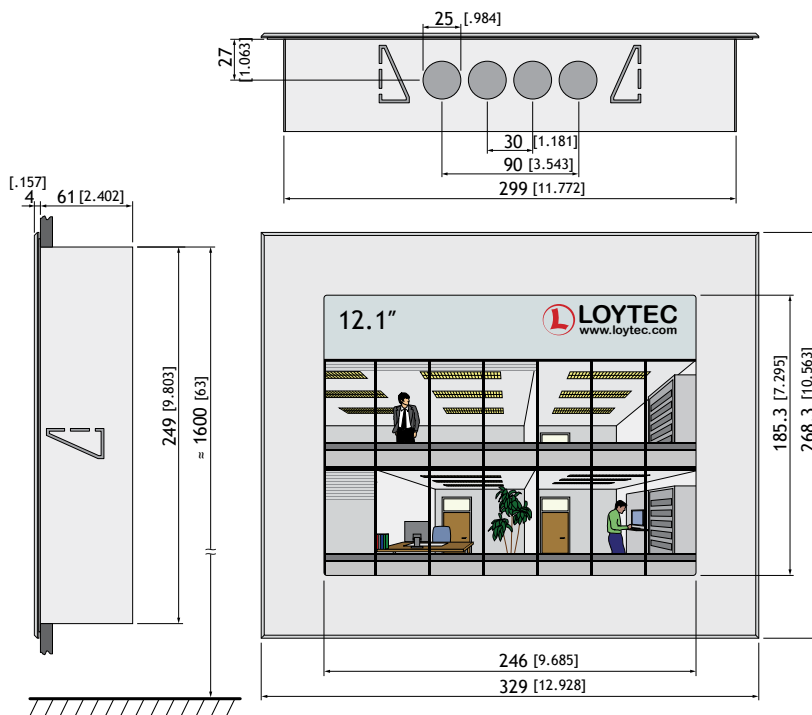

Dimensions of the devices in mm and [inch]

DIM003 LVIS-3ME15-A1
 LVIS-3ME15-Gx

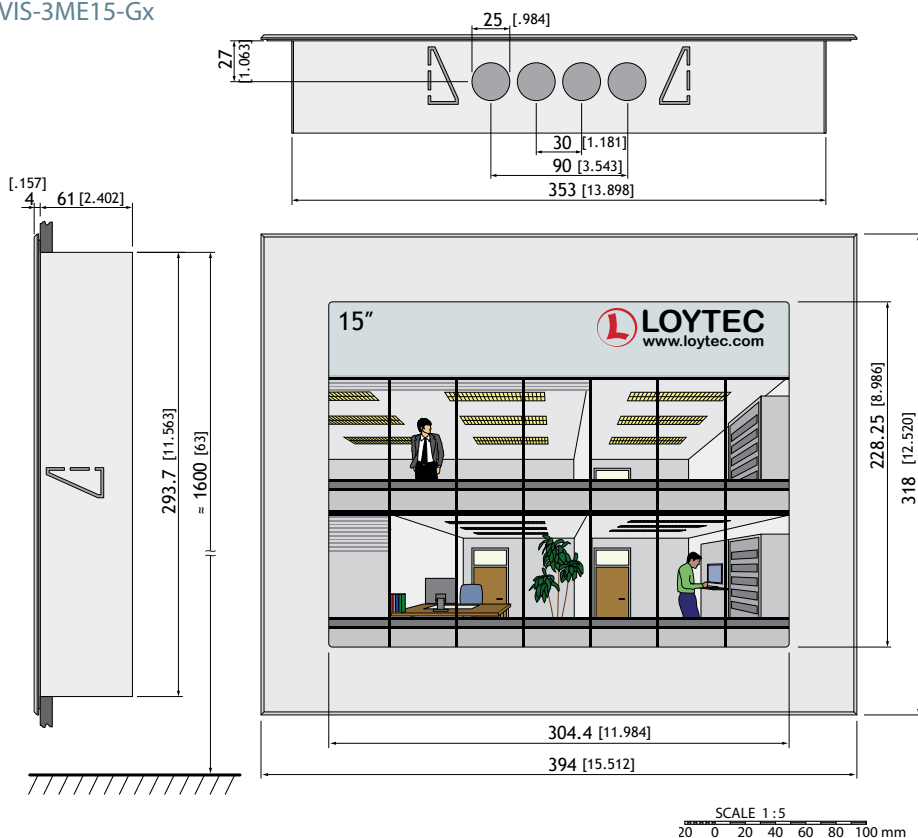

DIM004 LVIS-3ME7-Gx

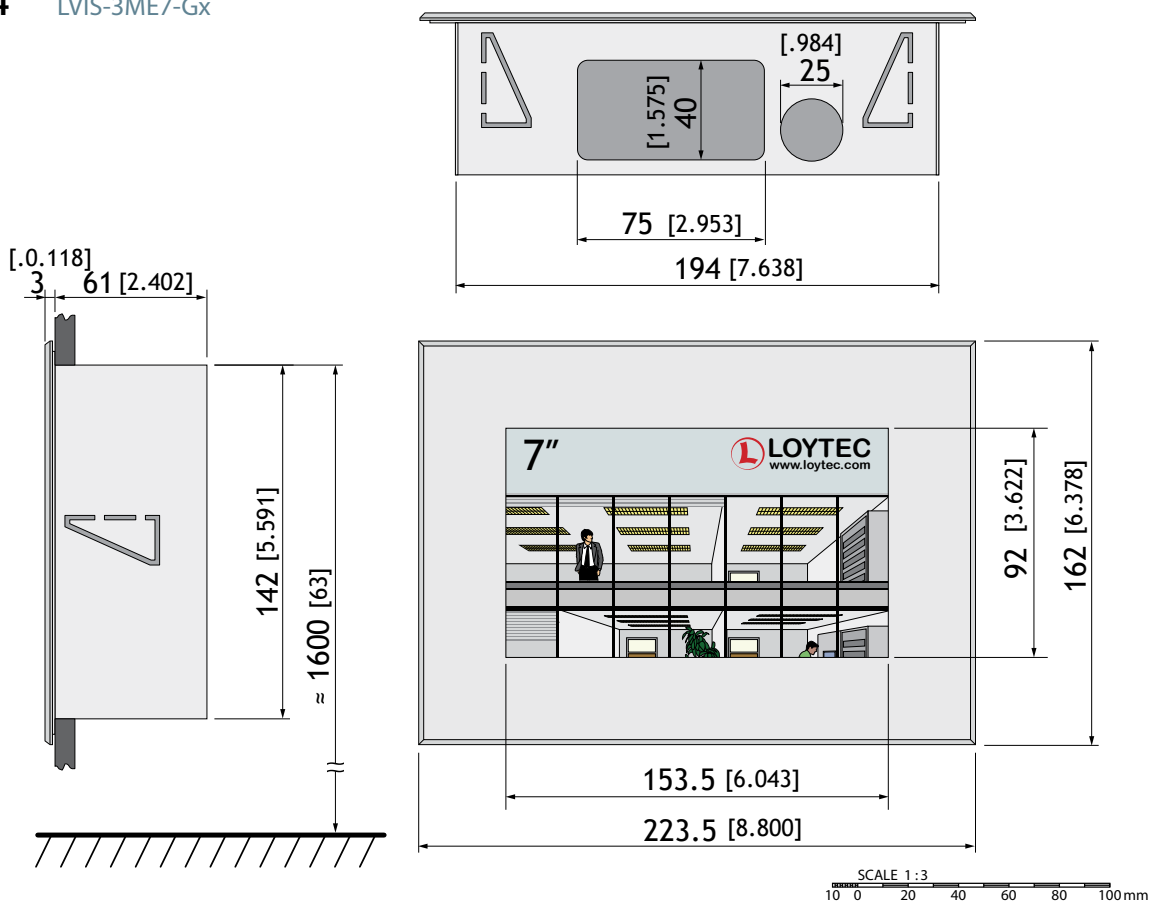

Dimensions of the devices in mm and [inch]

DIM005 LIOB-586
LIOB-587

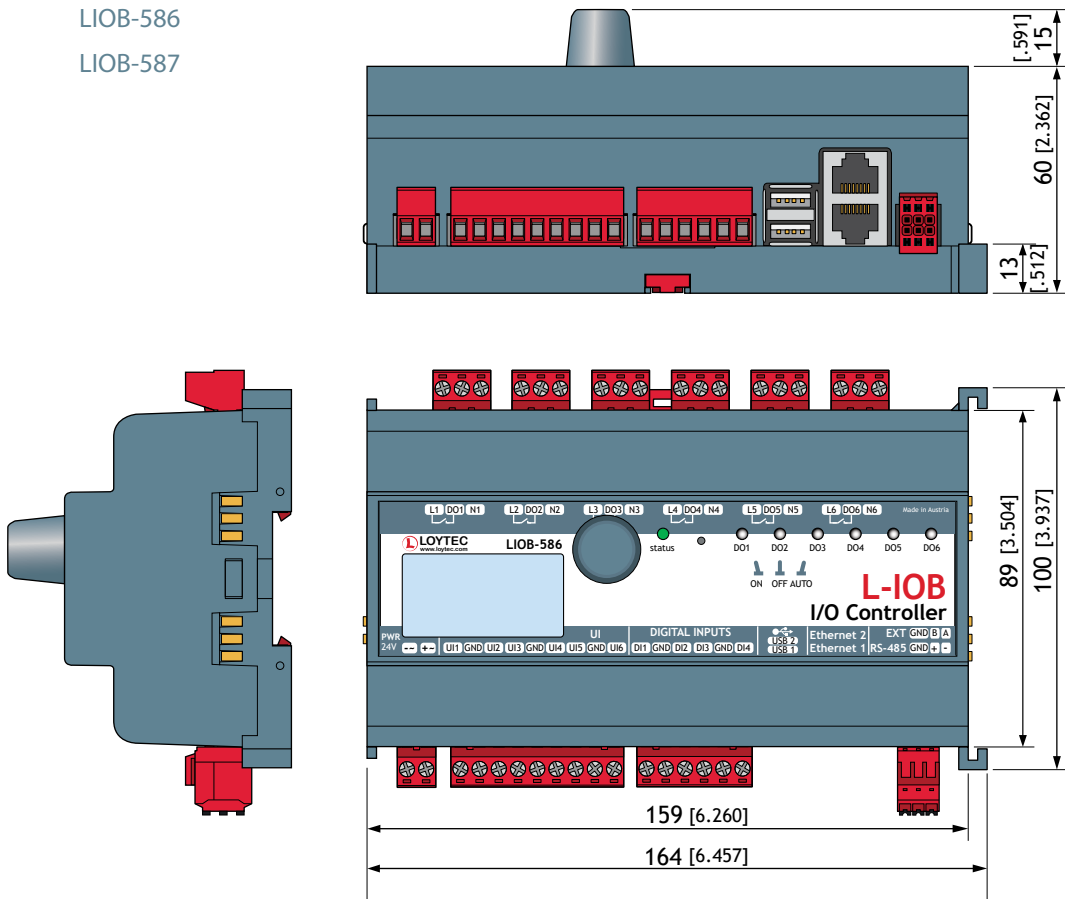

DIM006 LIOB-588

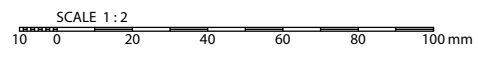
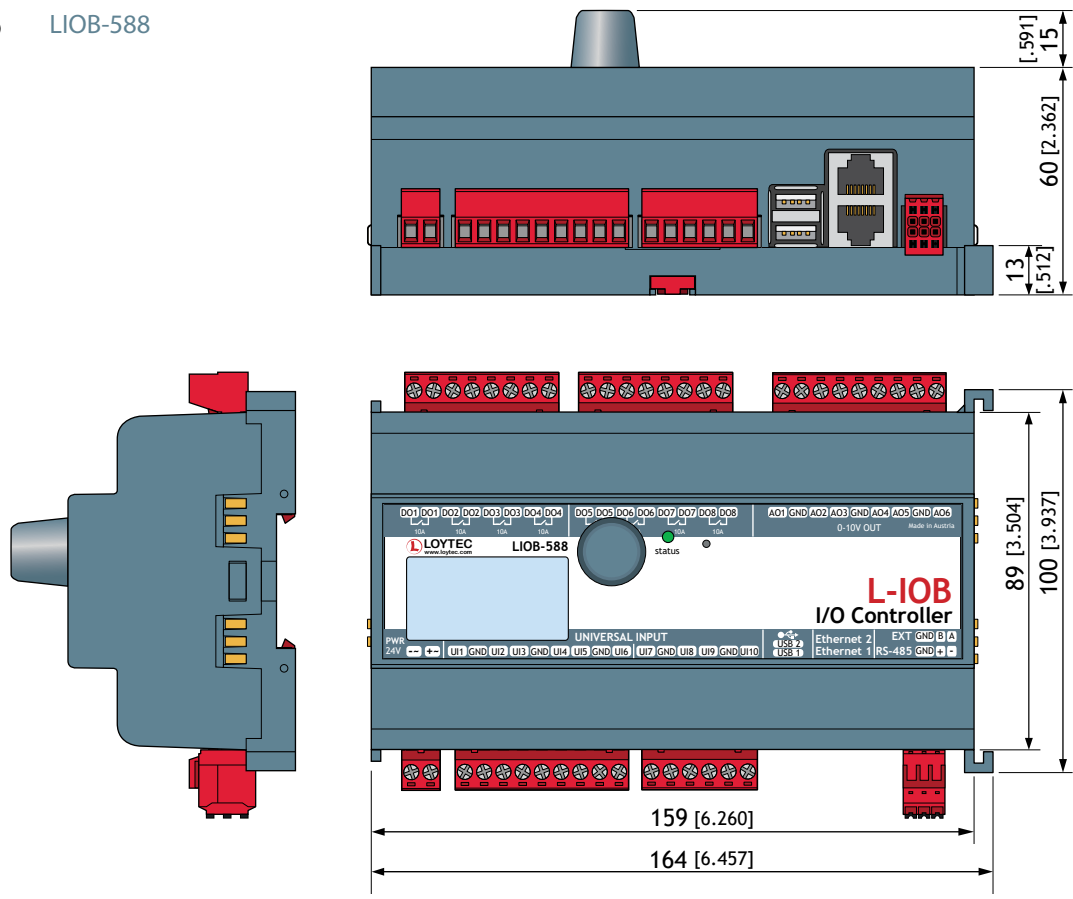

Dimensions of the devices in mm and [inch]

DIM007 LIOB-589

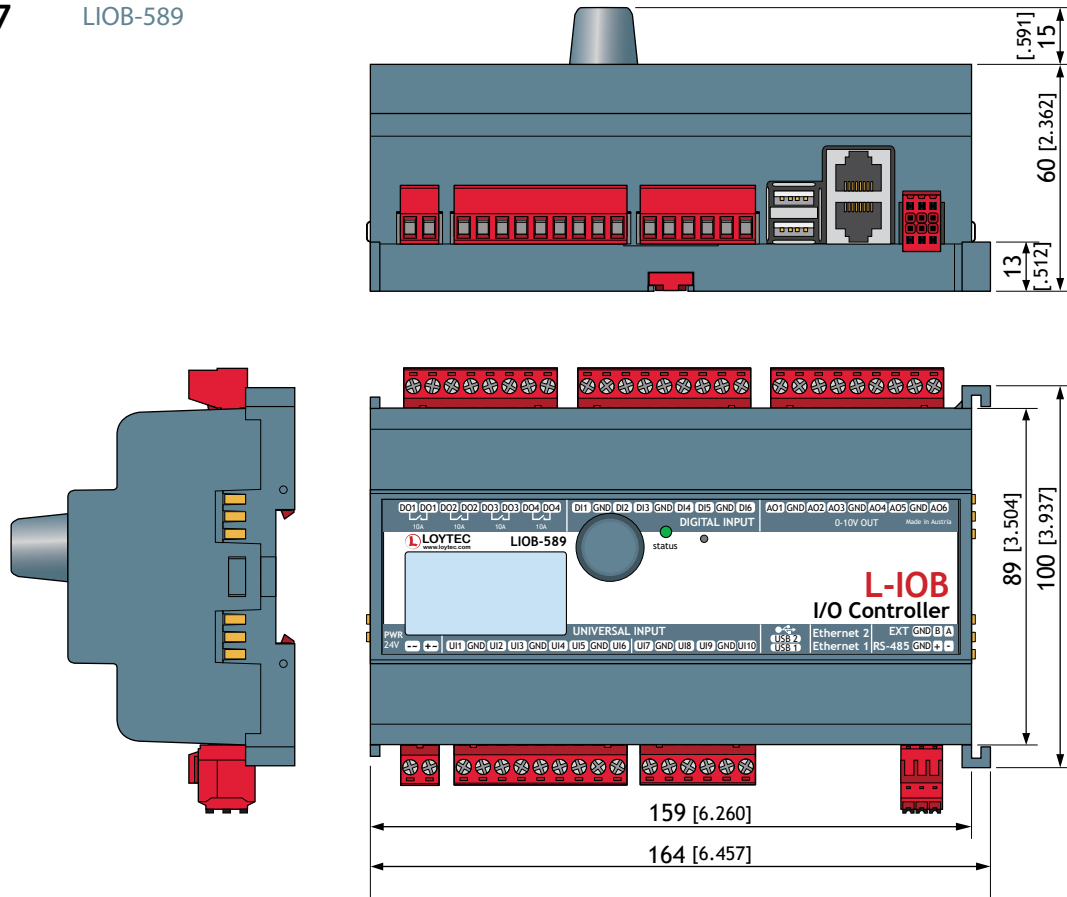

DIM008 L-ACT101-MP
L-ACT102-MP

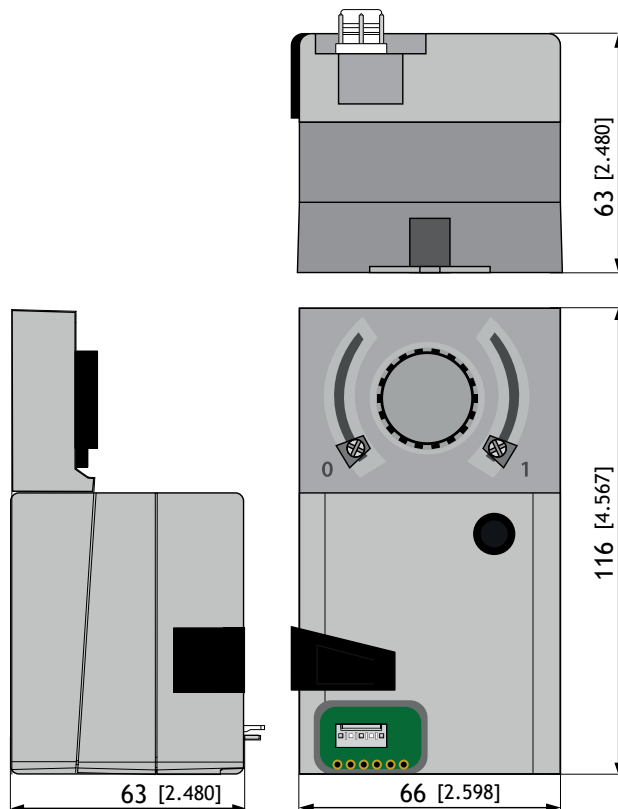

Dimensions of the devices in mm and [inch]

DIM009 LOYBT-IO1

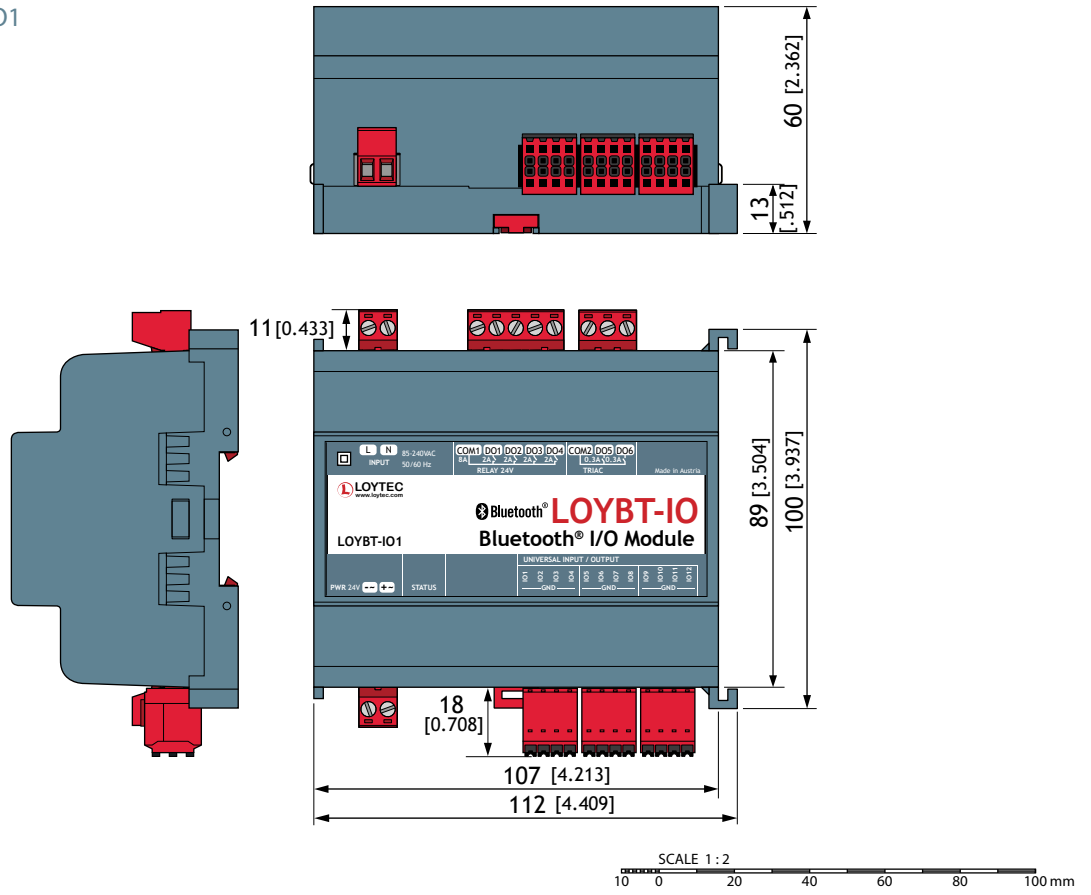

DIM010 LTE-800

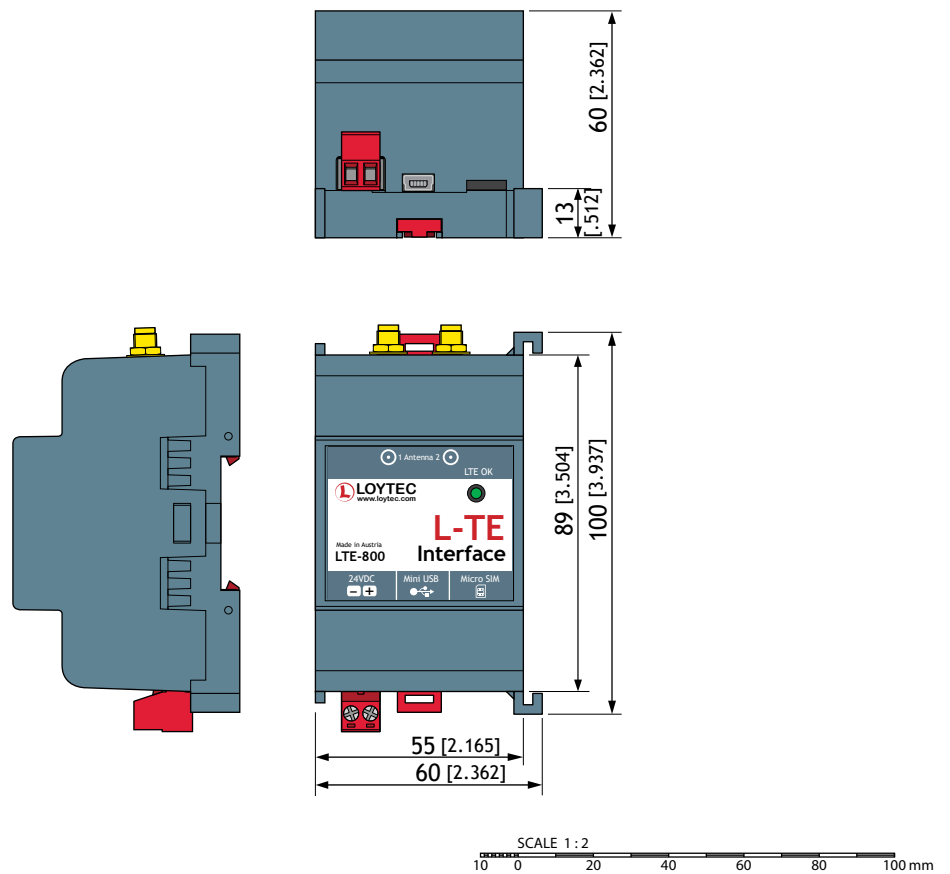

Dimensions of the devices in mm and [inch]

DIM011 LIOB-100

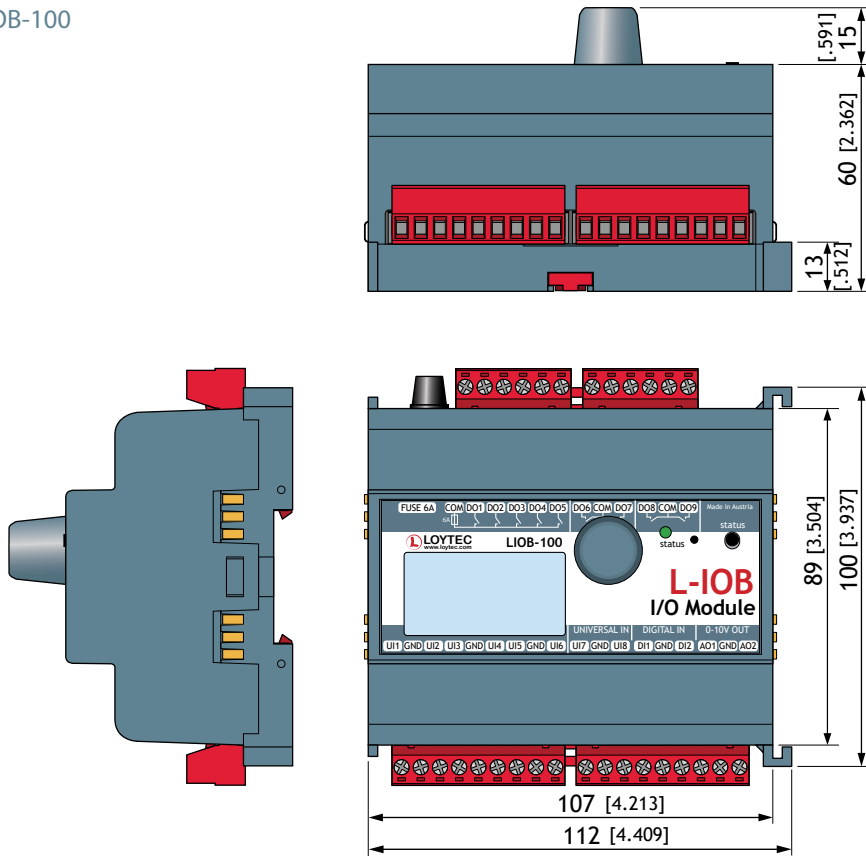

DIM012 LIOB-101

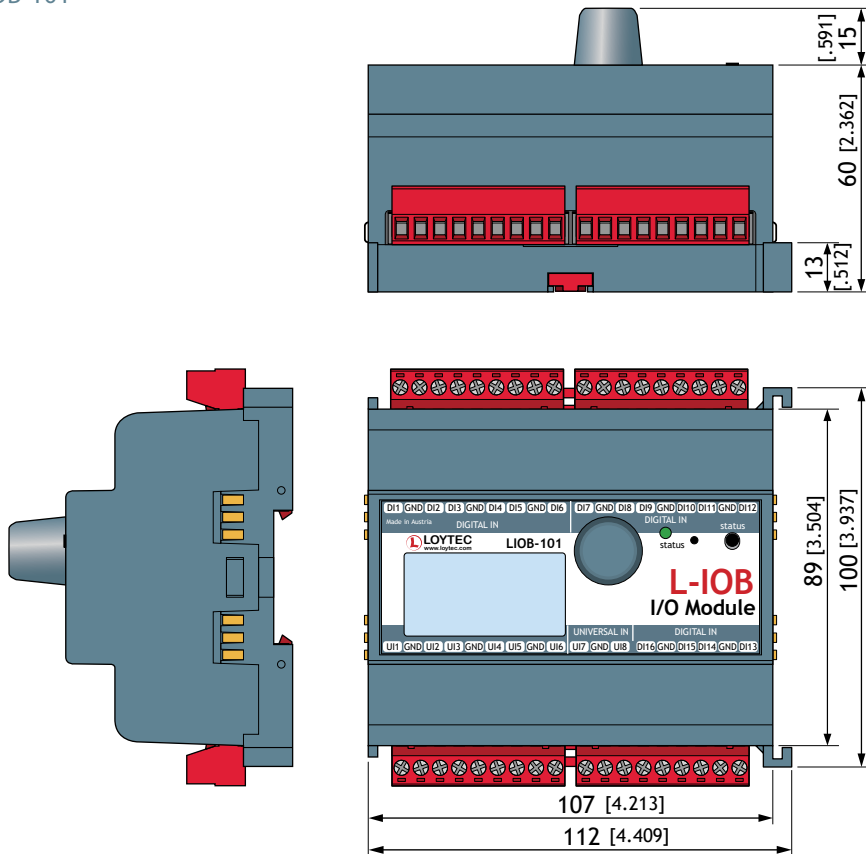

Dimensions of the devices in mm and [inch]

DIM013 LIOB-102

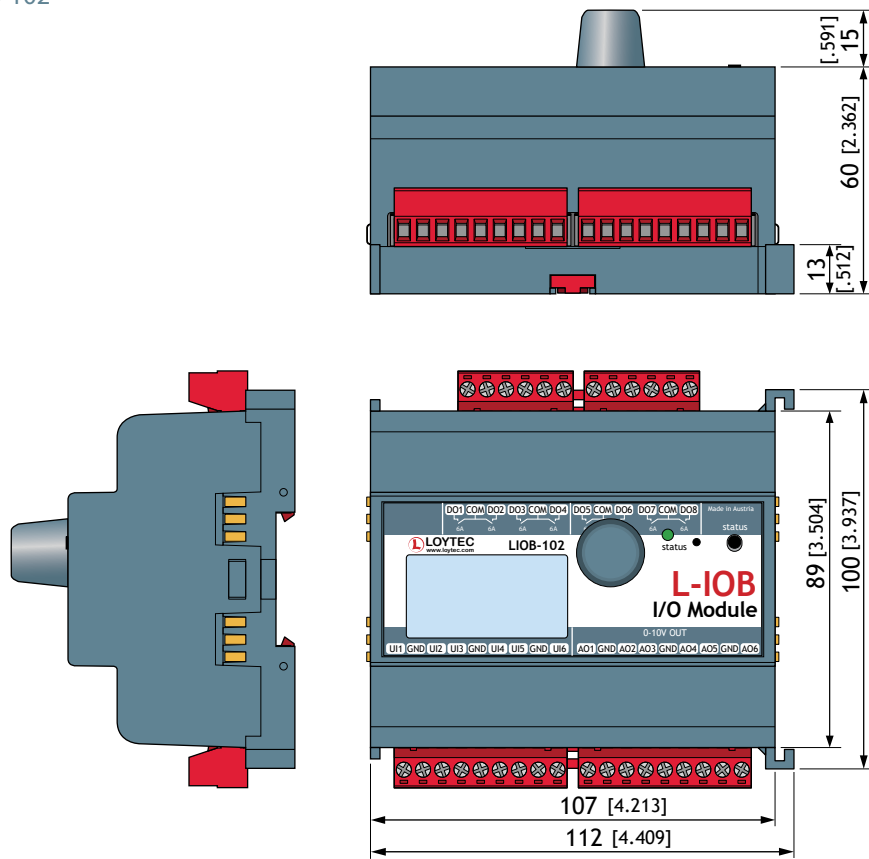

DIM014 LIOB-103

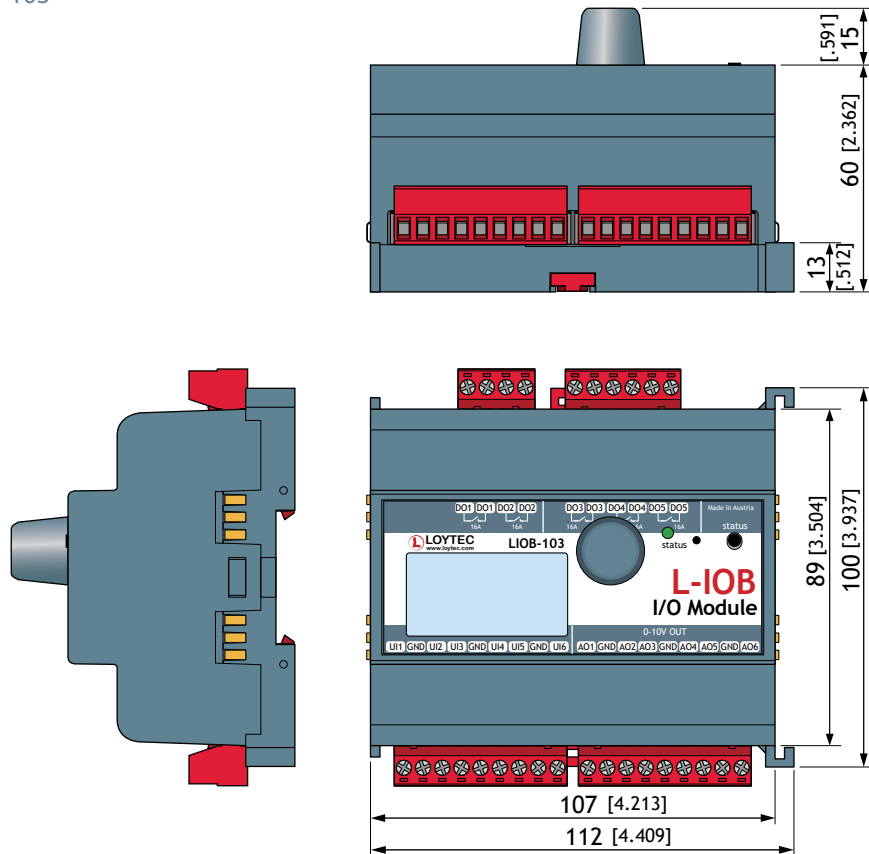

Dimensions of the devices in mm and [inch]

DIM015 LIOB-150
LIOB-151
LIOB-152

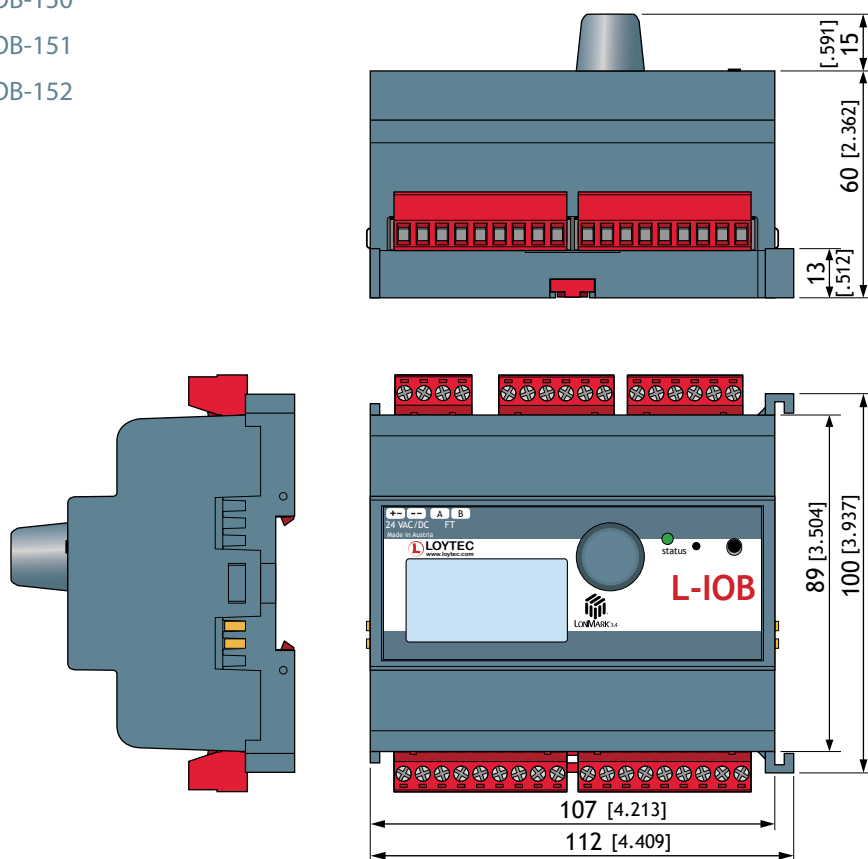

DIM016 LIOB-153

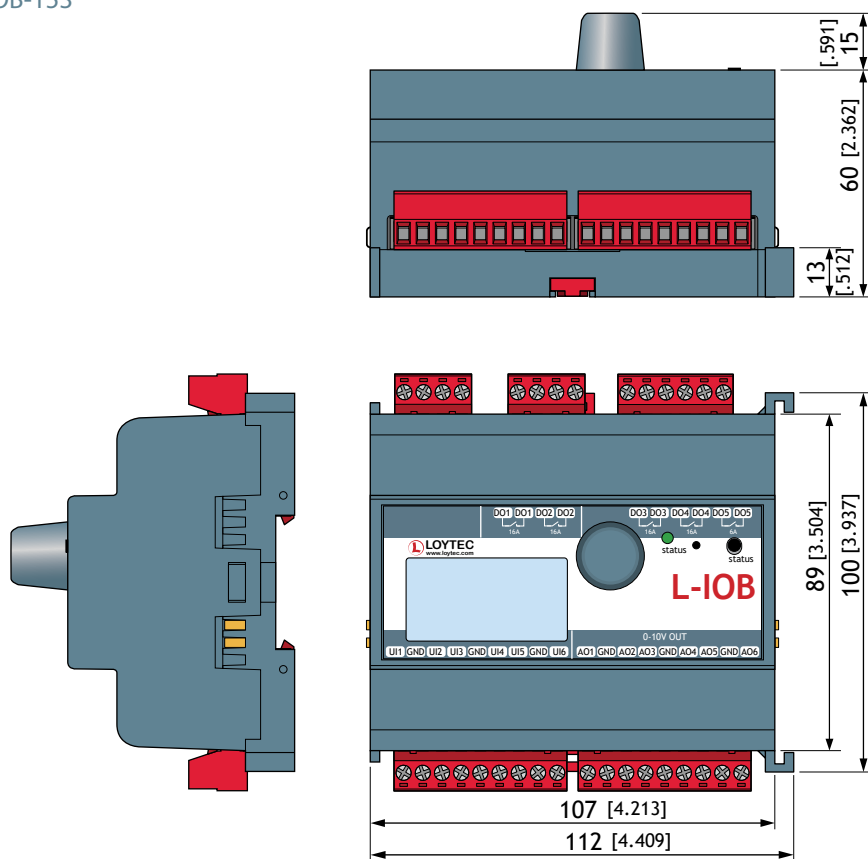

Dimensions of the devices in mm and [inch]

DIM017 LIOB-154

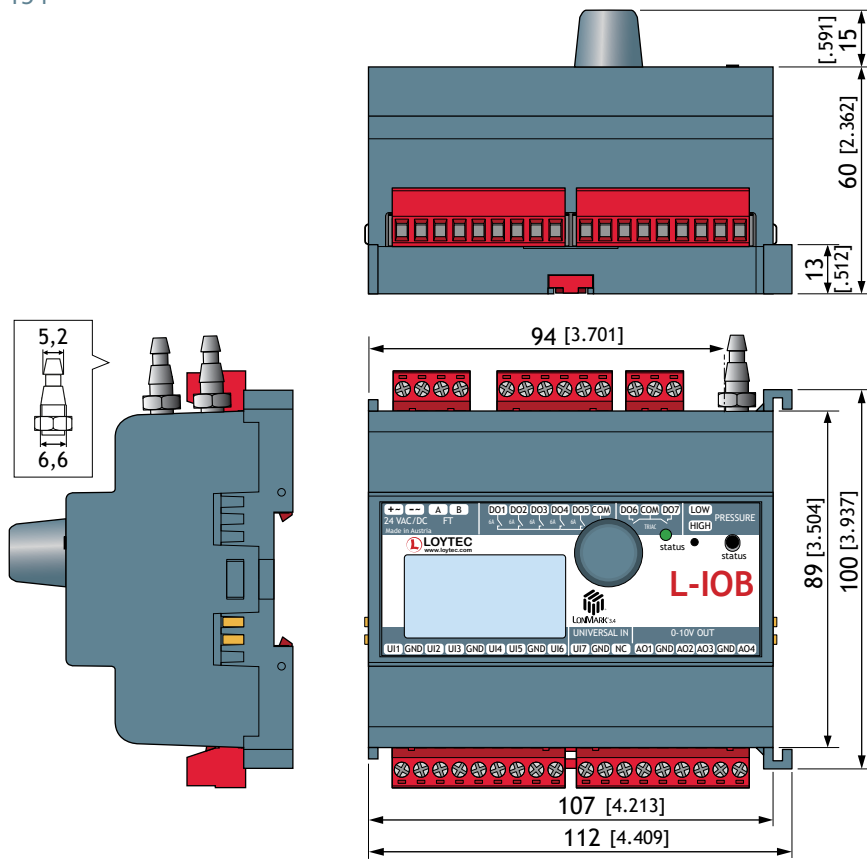

DIM018 LIOB-450
LIOB-550

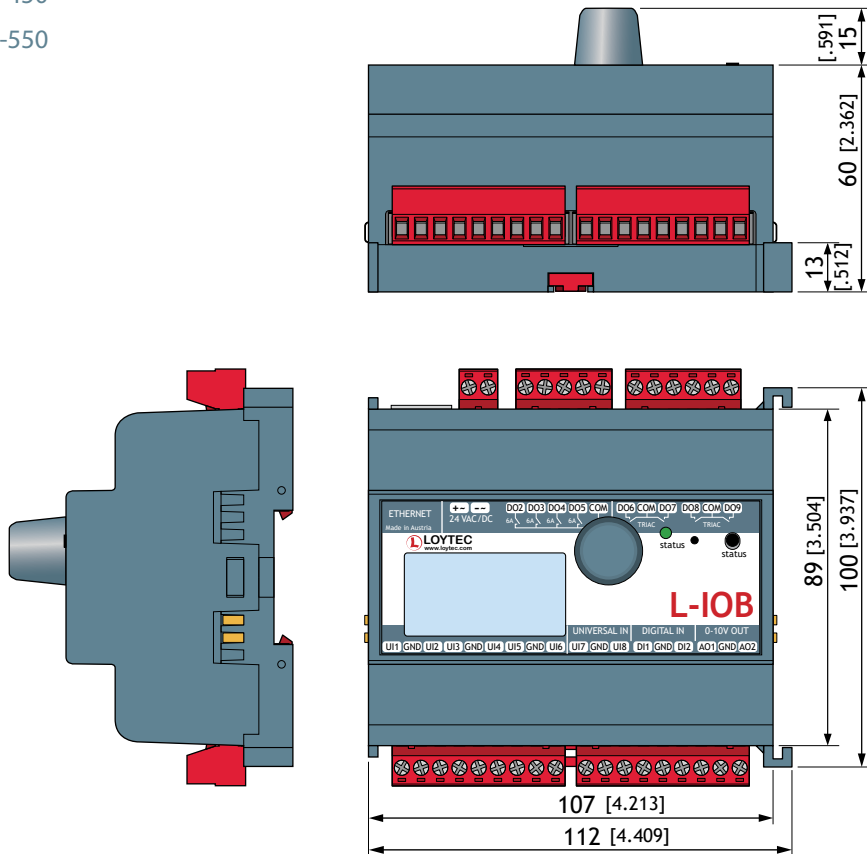

Dimensions of the devices in mm and [inch]

DIM019 LIOB-451
 LIOB-551

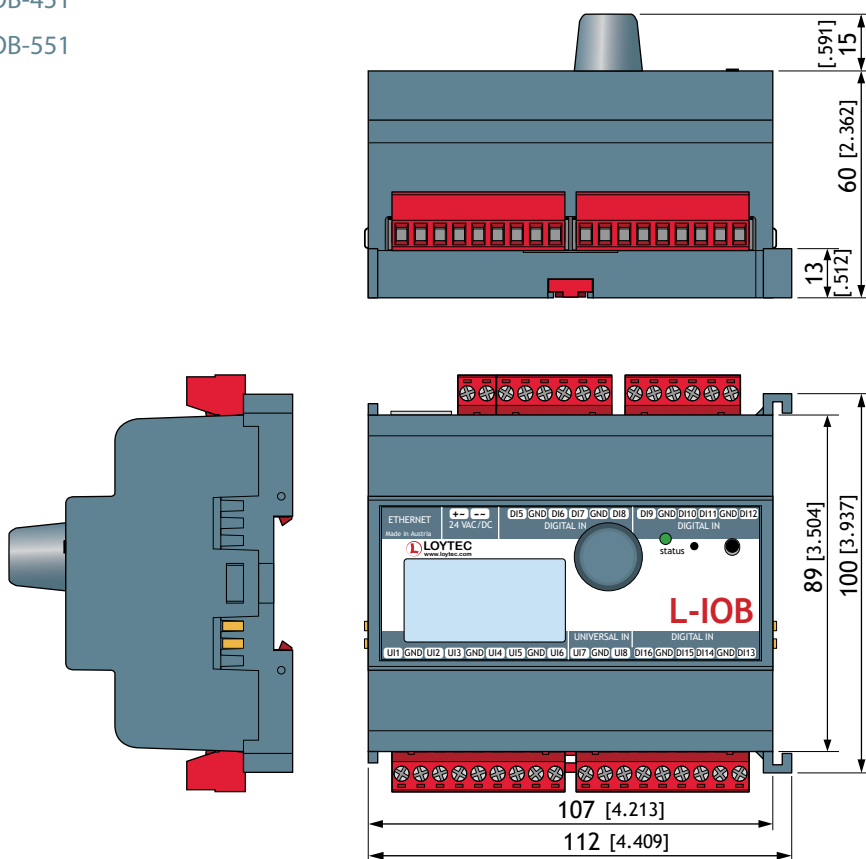

DIM020 LIOB-452
 LIOB-552

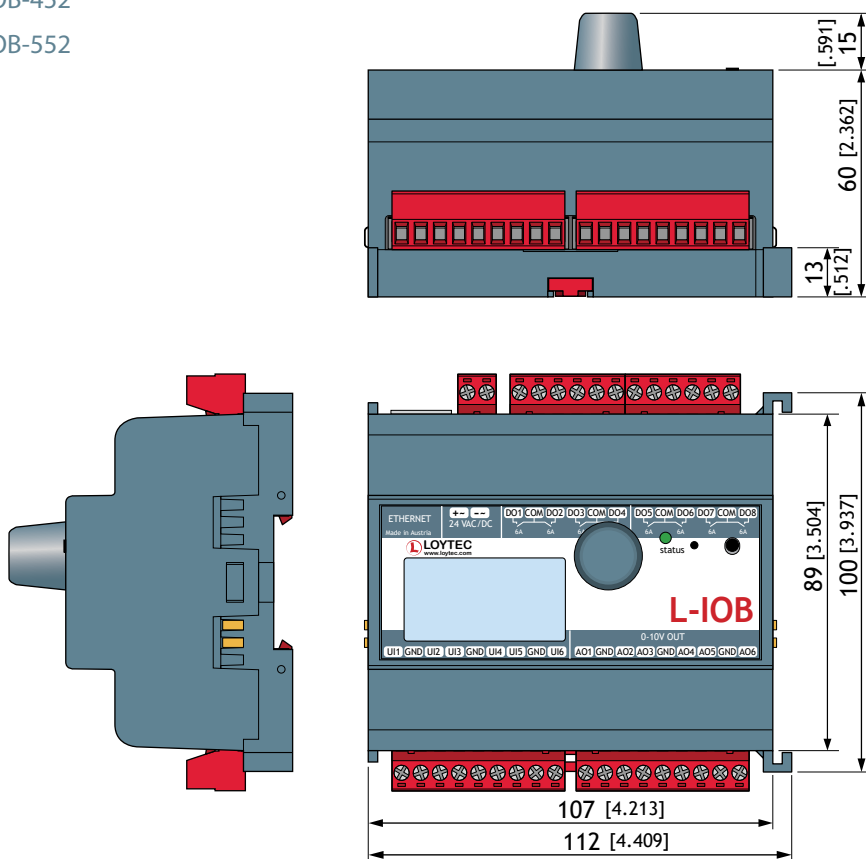

Dimensions of the devices in mm and [inch]

DIM021 LIOB-453
LIOB-553

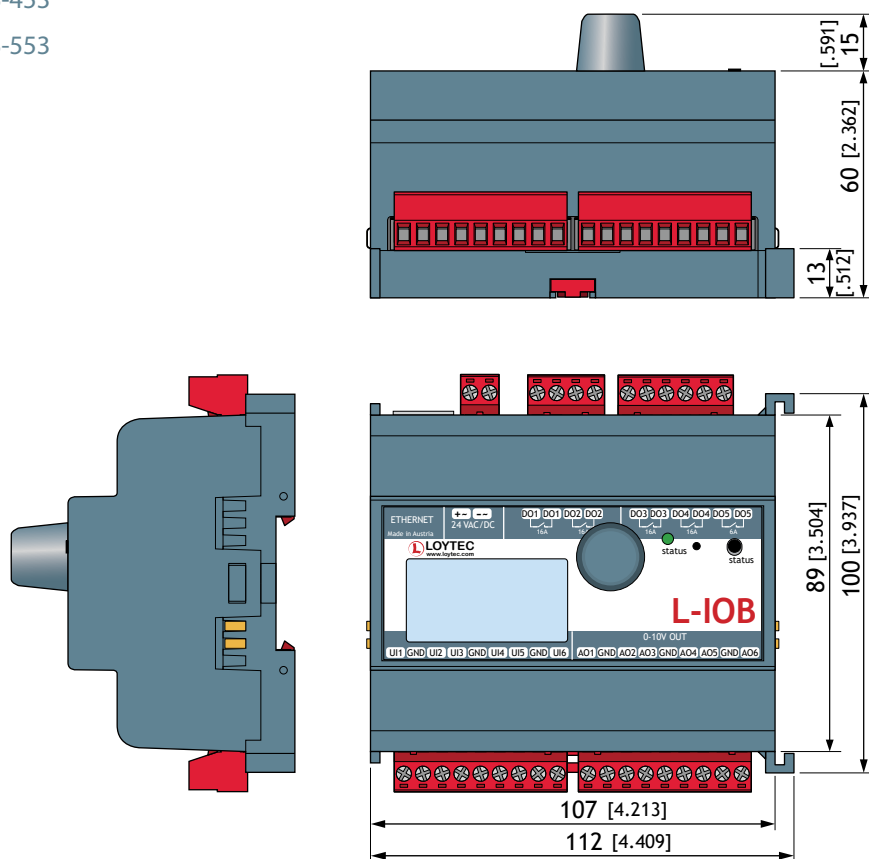

DIM022 LIOB-454
LIOB-554

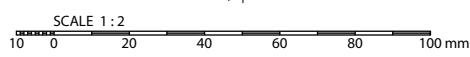
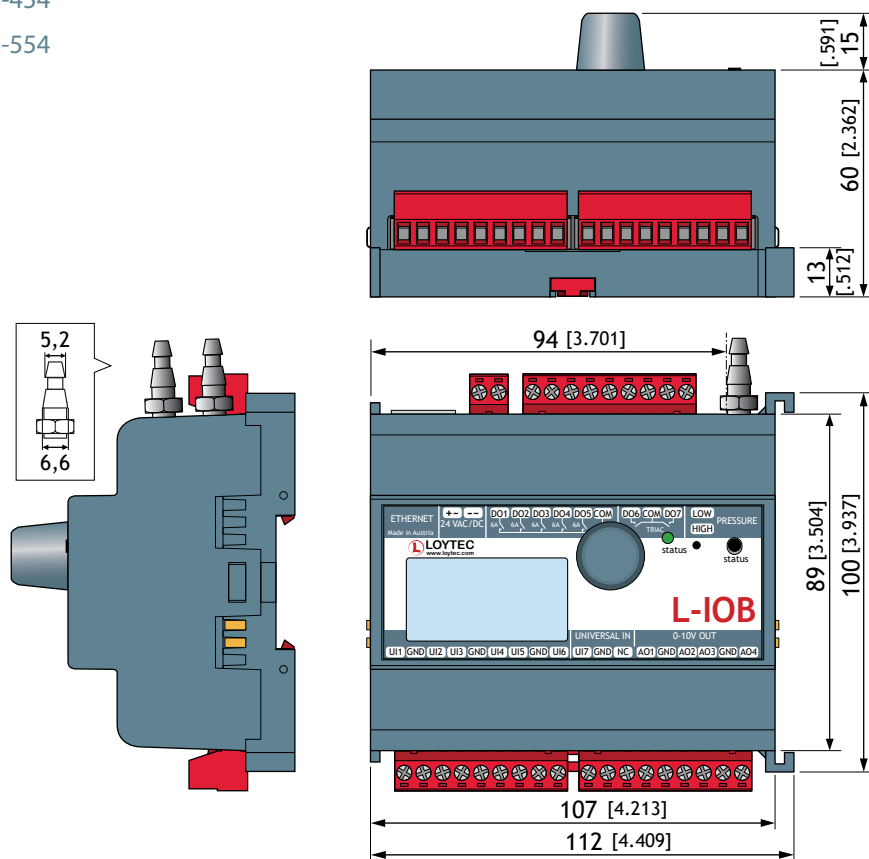

Dimensions of the devices in mm and [inch]

DIM023 LDALI-PWR2-U
 LDALI-PWR4-U

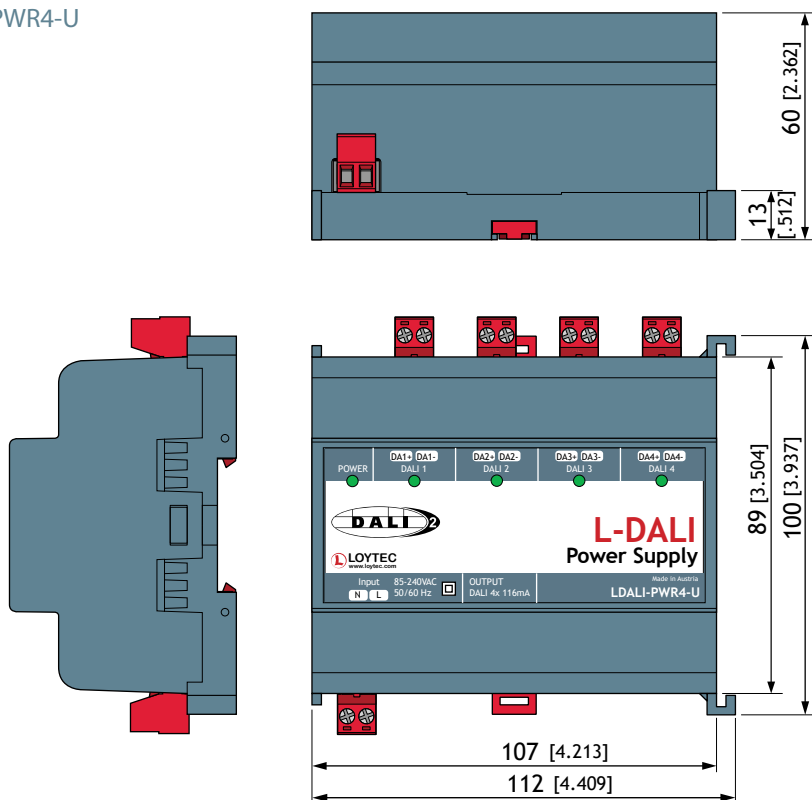

DIM024 L-MBUS20
 L-MBUS80

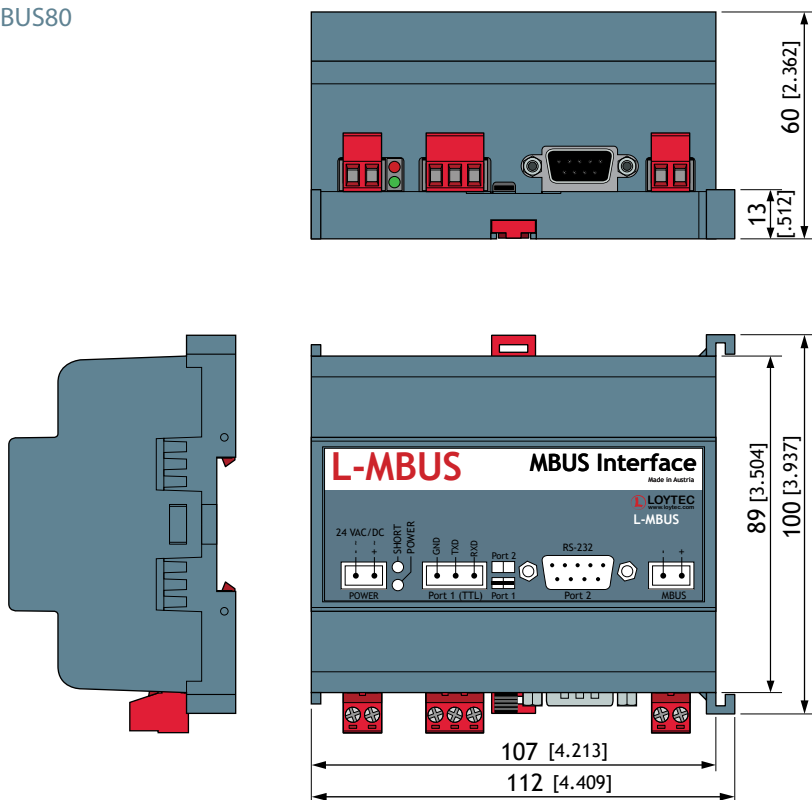

SCALE 1:2
 10 0 20 40 60 80 100 mm

Dimensions of the devices in mm and [inch]

DIM025 LPOW-2415A

DIM026 LPOW-2415B

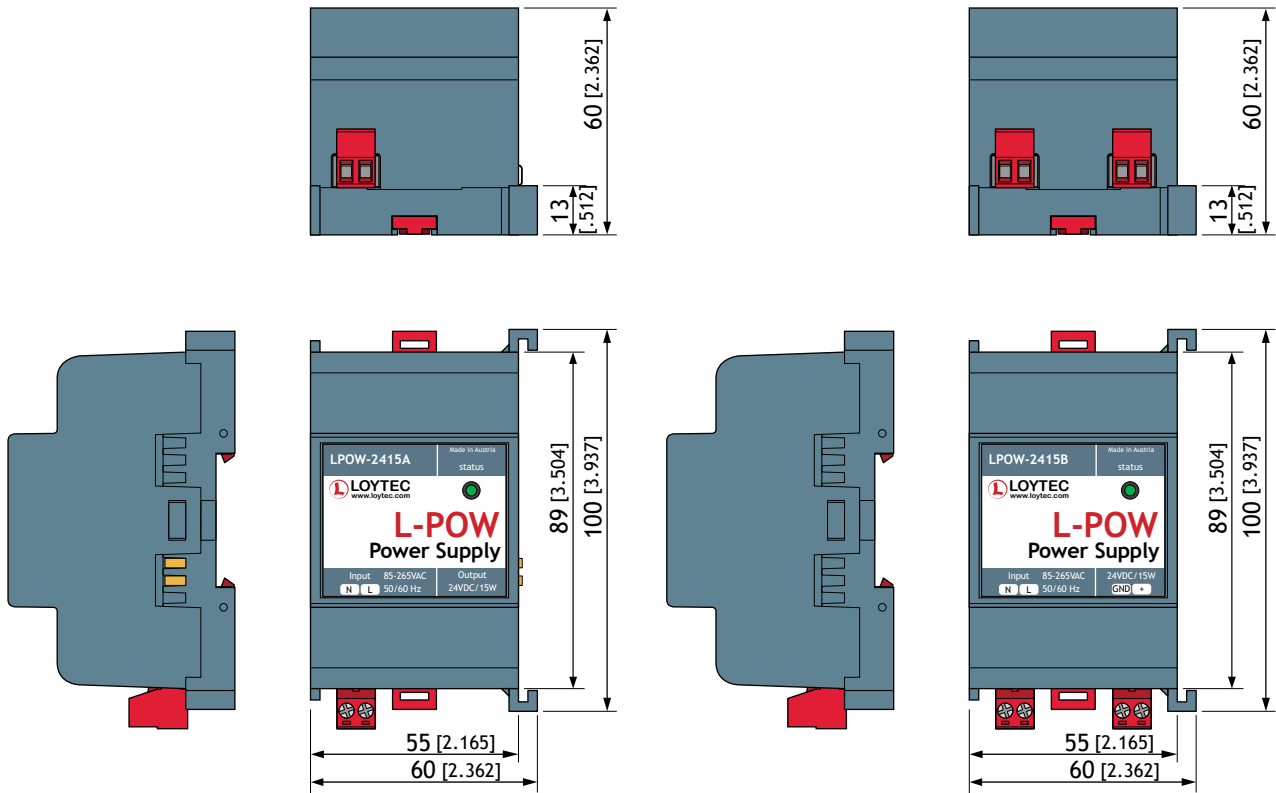

DIM027 LT-03
LT-04
LT-13
LT-33
LT-B4

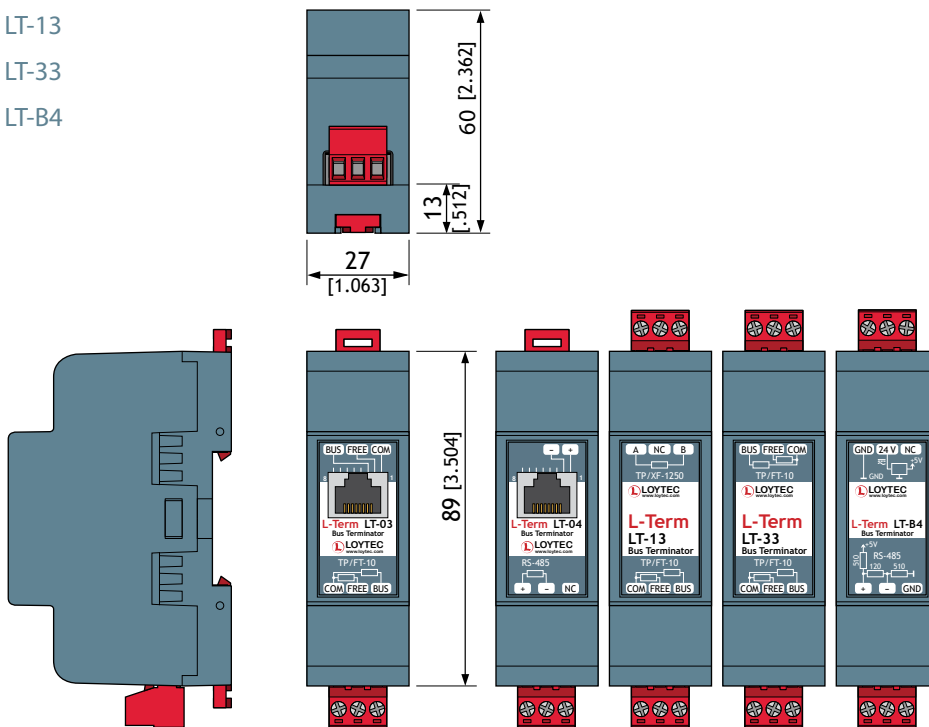

SCALE 1:2
10 0 20 40 60 80 100 mm

Dimensions of the devices in mm and [inch]

DIM028 LKNX-300

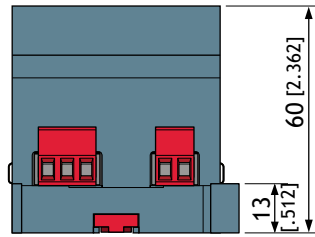

DIM029 LIOB-A2

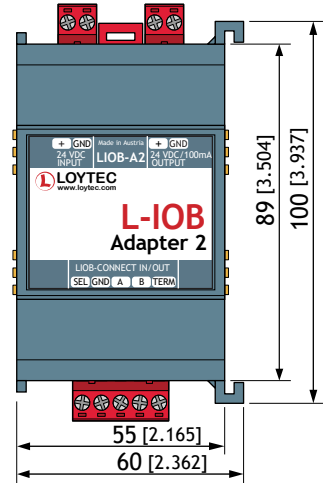
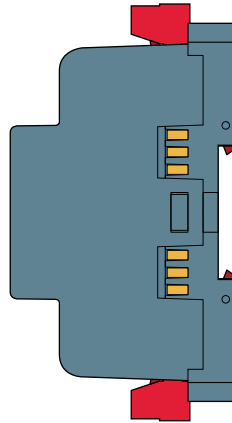
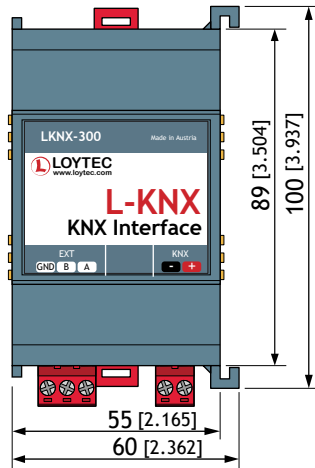
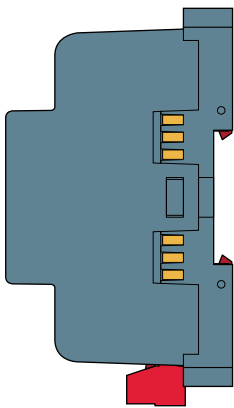
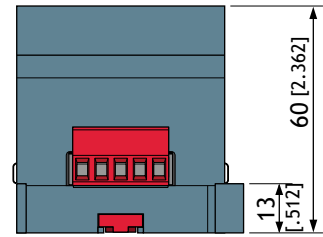

DIM030 LIOB-A4

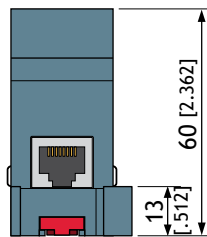

DIM031 LIOB-A5

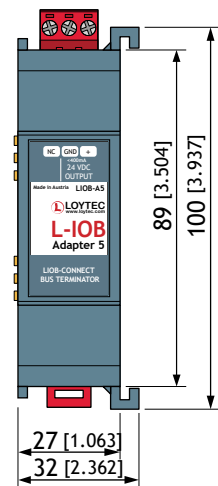
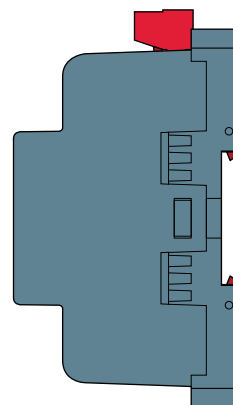
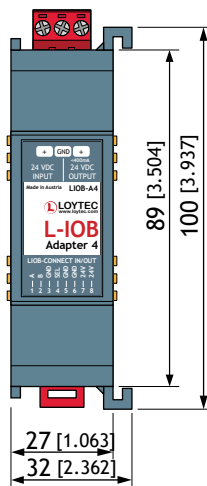
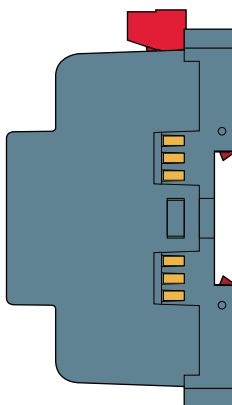
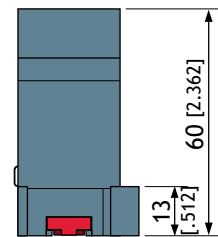

Dimensions of the devices in mm and [inch]

DIM032 LSTAT-800-Gx-Lx
LSTAT-801-Gx-Lx
LSTAT-802-Gx-Lx

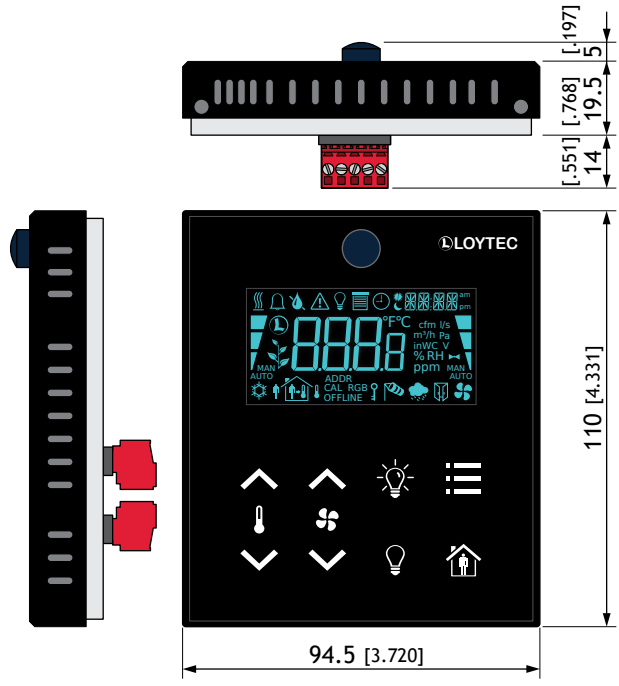

DIM033 LSMI-800

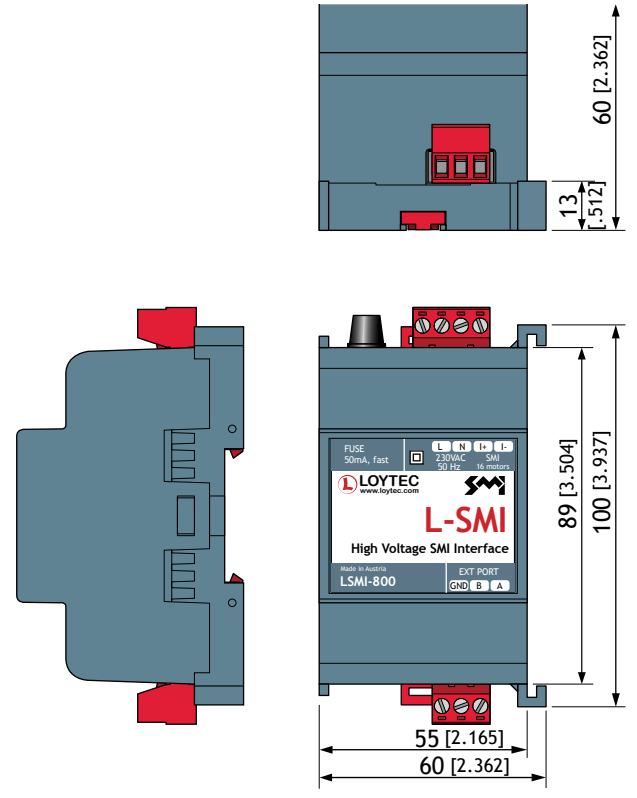

DIM034 LSMI-804

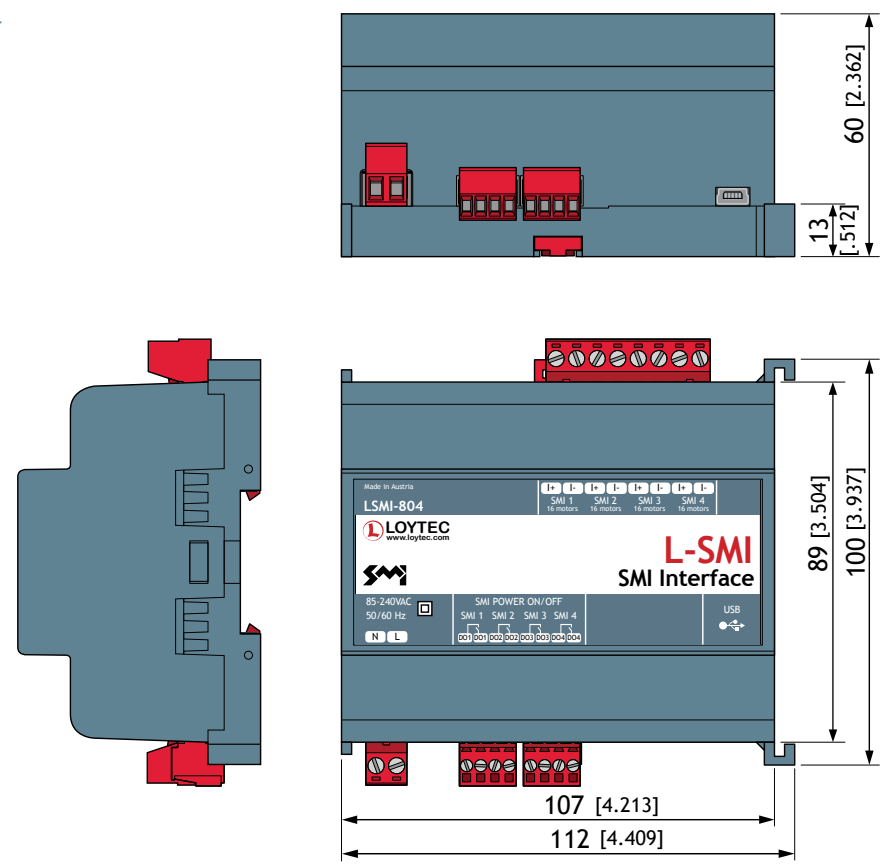

Dimensions of the devices in mm and [inch]

DIM035

- LDALI-3E101-U
- LDALI-3E102-U
- LDALI-3E104-U
- LDALI-ME201-U
- LDALI-ME202-U
- LDALI-ME204-U
- LDALI-PLC2
- LDALI-PLC4

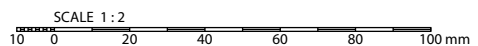
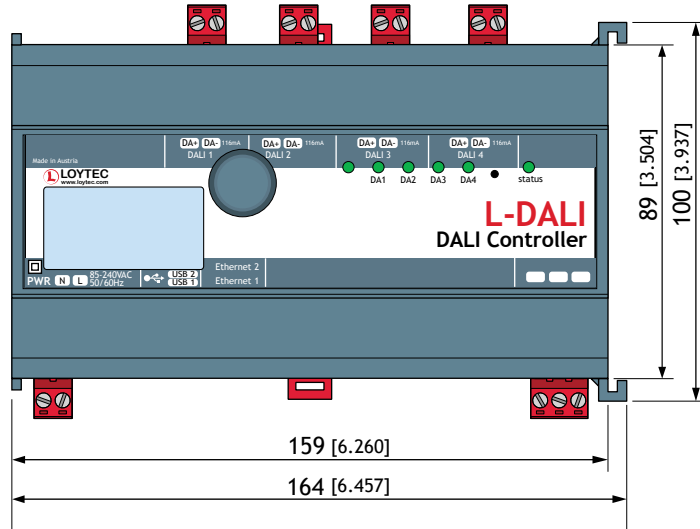
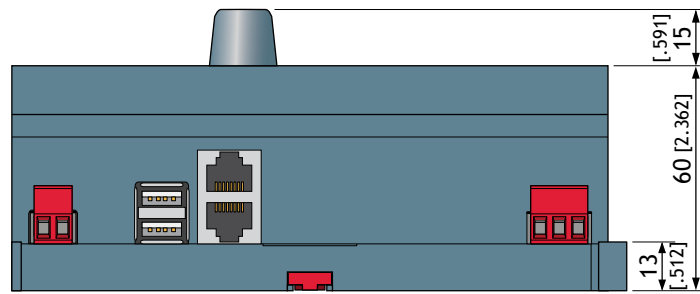
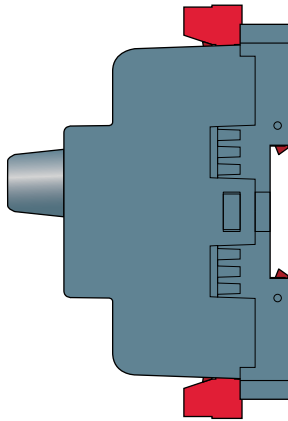

Dimensions of the devices in mm and [inch]

DIM037 LENO-800
LENO-801
LENO-802

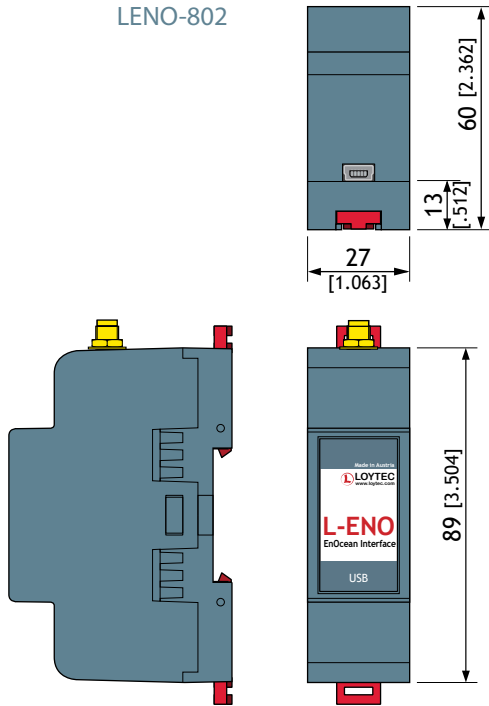

DIM038 LWLAN-800

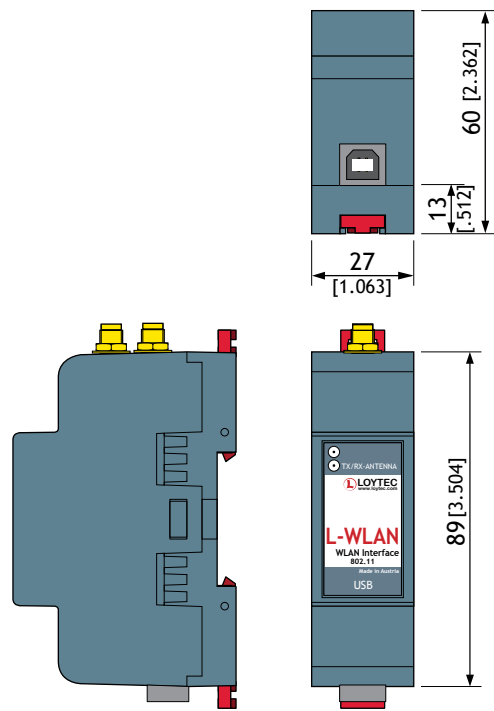

DIM039 L-RC1

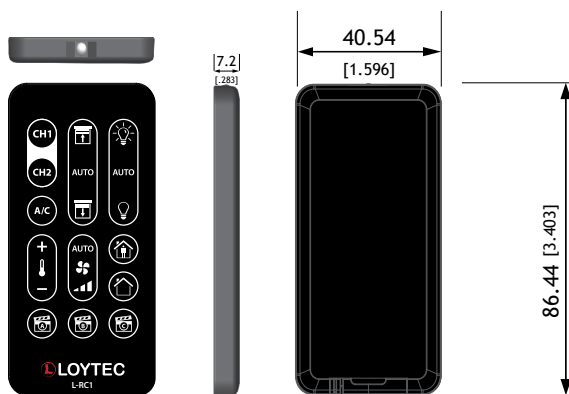

DIM040 WLAN Antenna 2.4 GHz
EnOcean Antenna 868 - 928 MHz

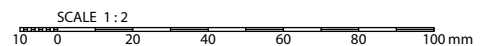
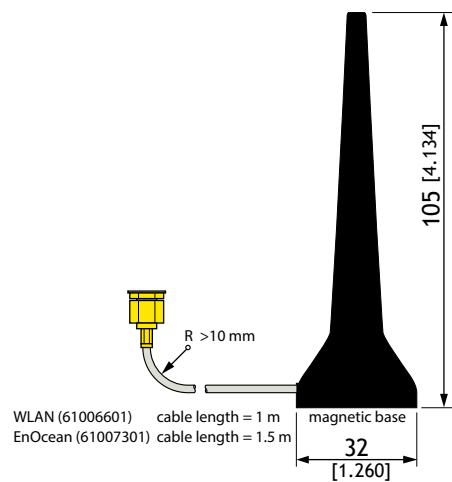

Dimensions of the devices in mm and [inch]

DIM041 LDALI-BM2

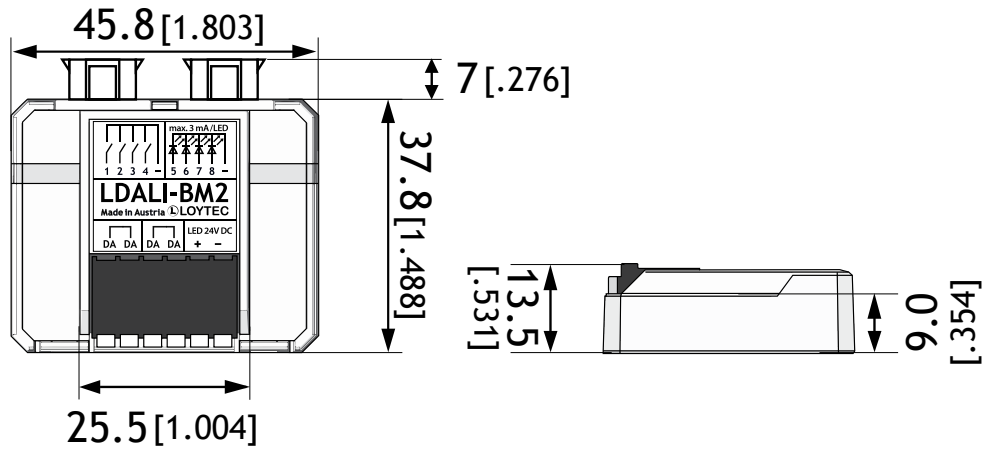

DIM042 LDALI-MS2-BT

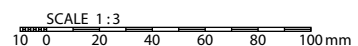
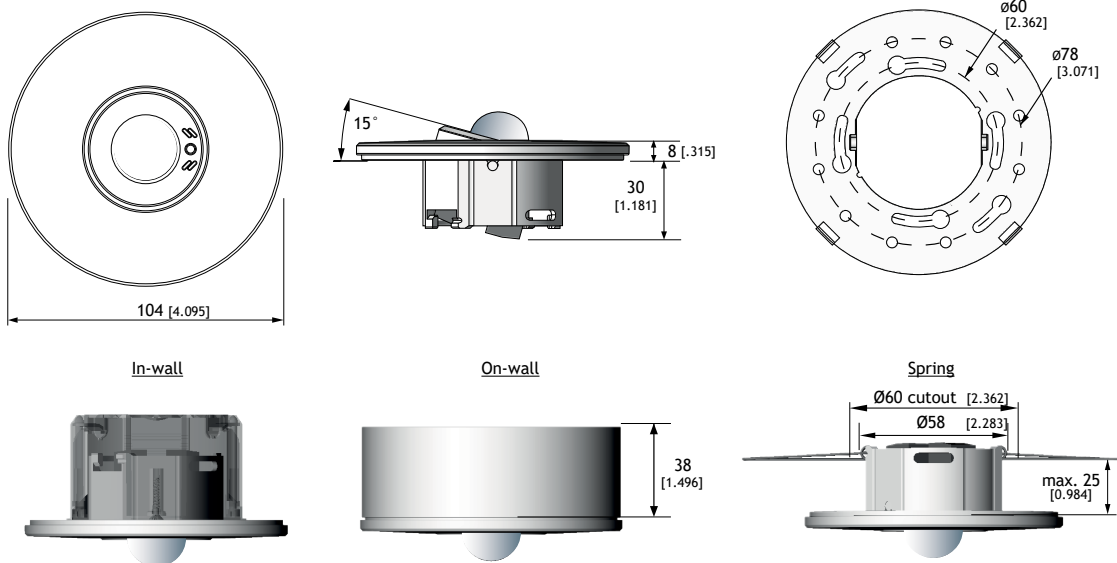

Functions

L-WEB, L-STUDIO

L-ROC

L-1NX

L-1OB

Gateways

LPAD-7,
L-VIS, L-STAT

L-DALI

Routers, NIC

Interfaces

Accessories

Dimensions of the devices in mm and [inch]

DIM043 LDALI-PWR1

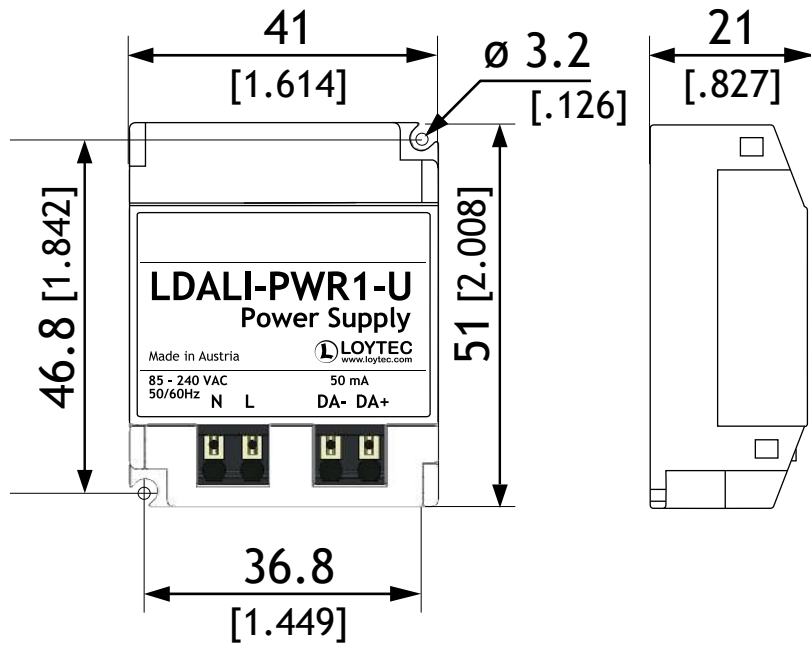

DIM044 LDALI-PD1

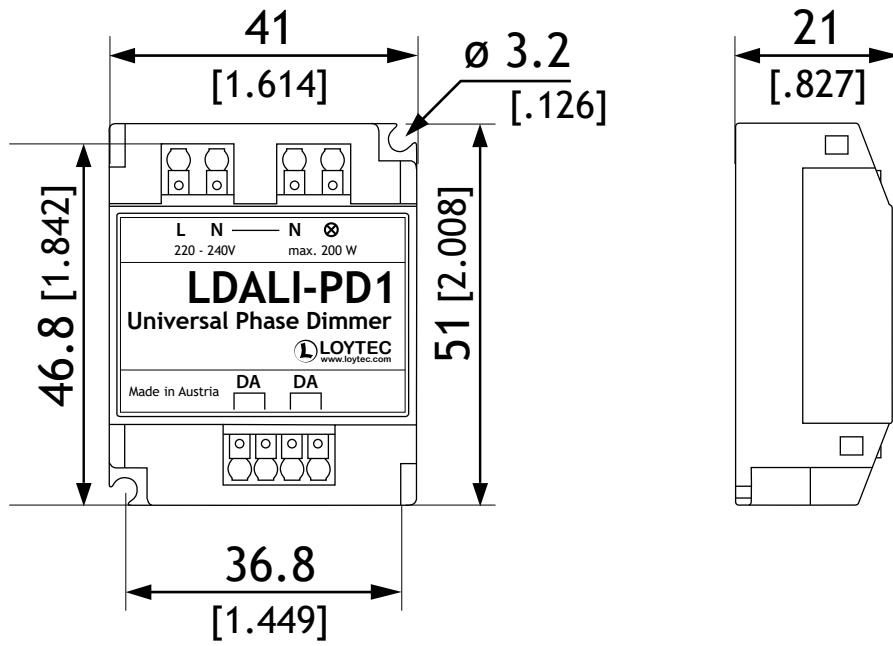

Dimensions of the devices in mm and [inch]

DIM045

- LINX-215
- LINX-102
- LINX-103
- LINX-202
- LINX-203
- LGATE-902

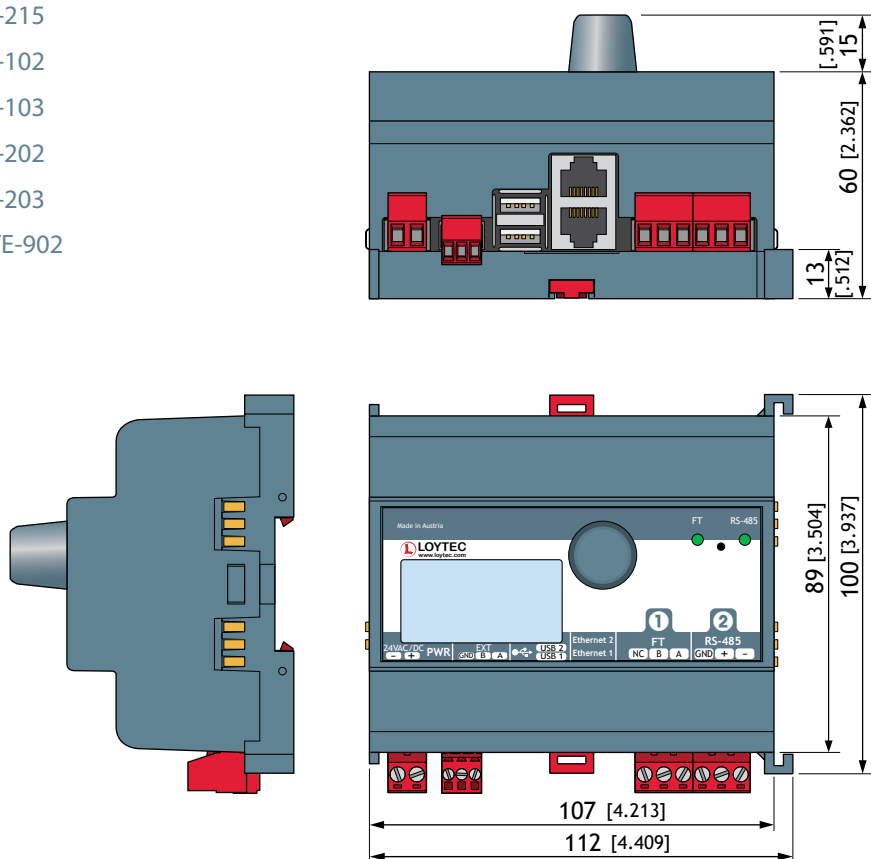

DIM046

- LIP-1ECTC
- LIP-3ECTC
- LIP-33ECTC
- LIP-ME201C
- LIP-ME202C
- NIC709-1E100C
- NIC709-3E100C

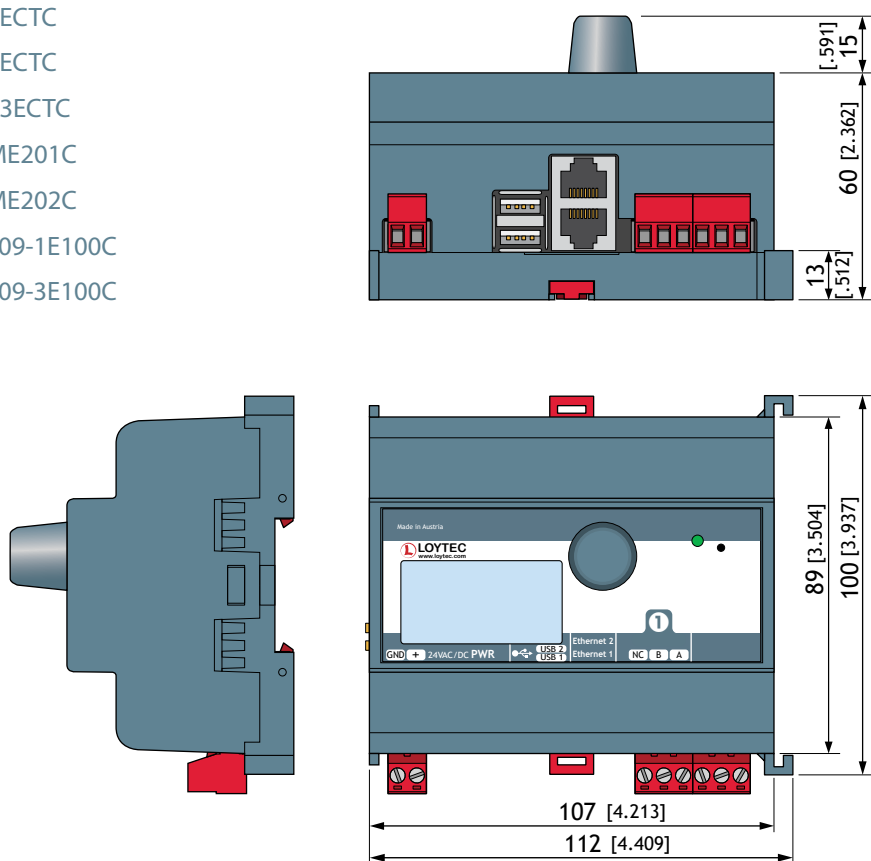

SCALE 1:2
10 0 20 40 60 80 100 mm

Dimensions of the devices in mm and [inch]

DIM047 LROC-400
LROC-401
LROC-402

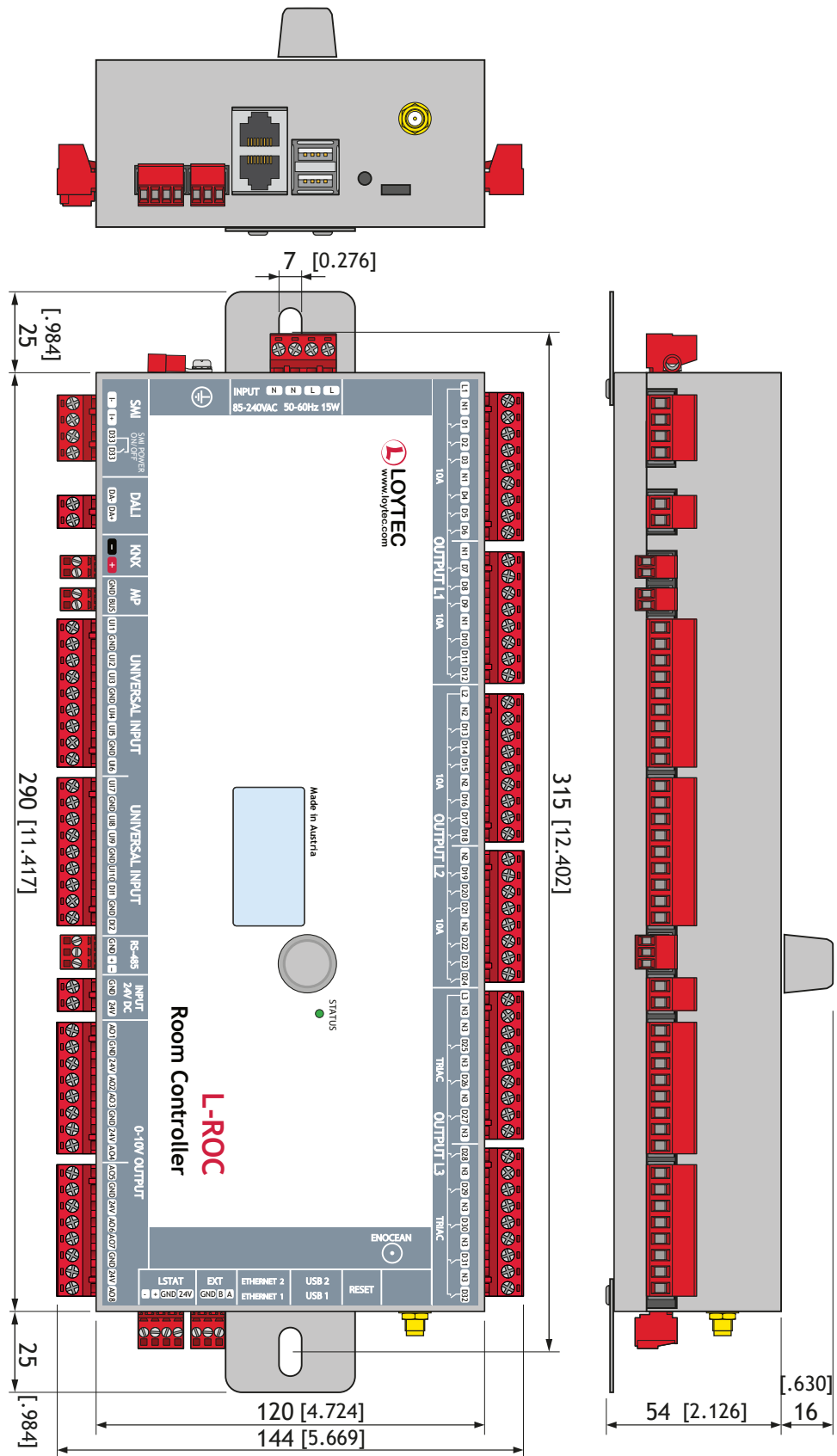

Dimensions of the devices in mm and [inch]

DIM048

LBOX-ROC1
LBOX-ROC2

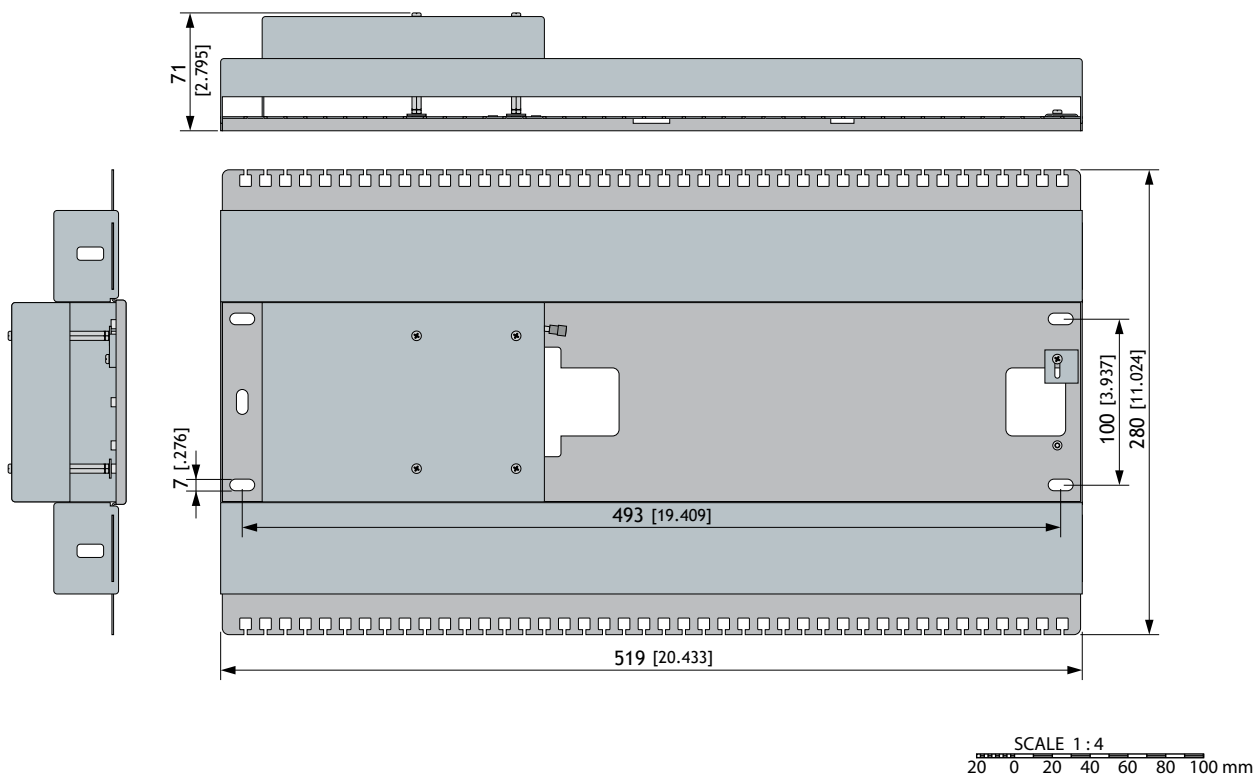

DIM049

LBOX-600

Metal
DC01
Sendzimir
galvanized

	L	W	A	M	N
LBOX-600	600 [23.622]	250 [9.843]	485 [19.094]	400 [15.748]	160 [6.299]

M, N ... mounting hole dimensions, \varnothing 8.0 [0.315]

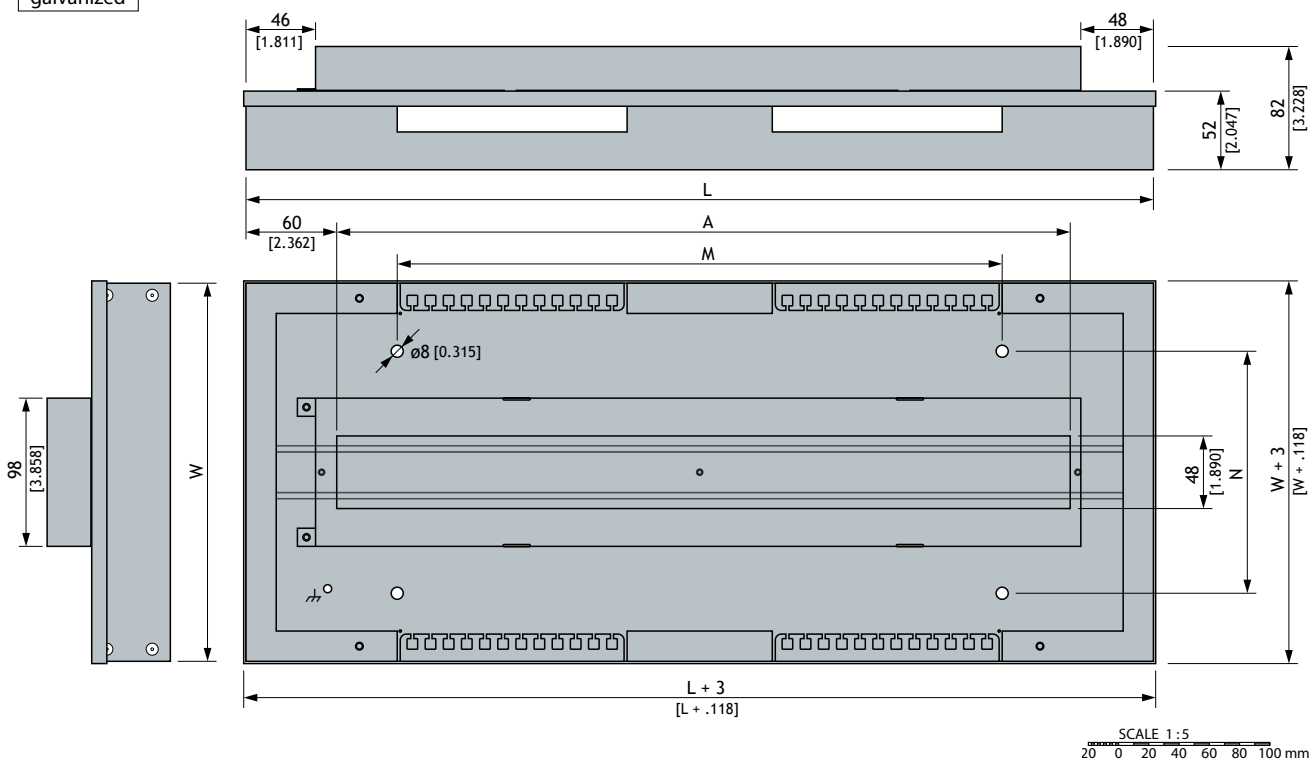

Dimensions of the devices in mm and [inch]

DIM050 LPOW-2460B

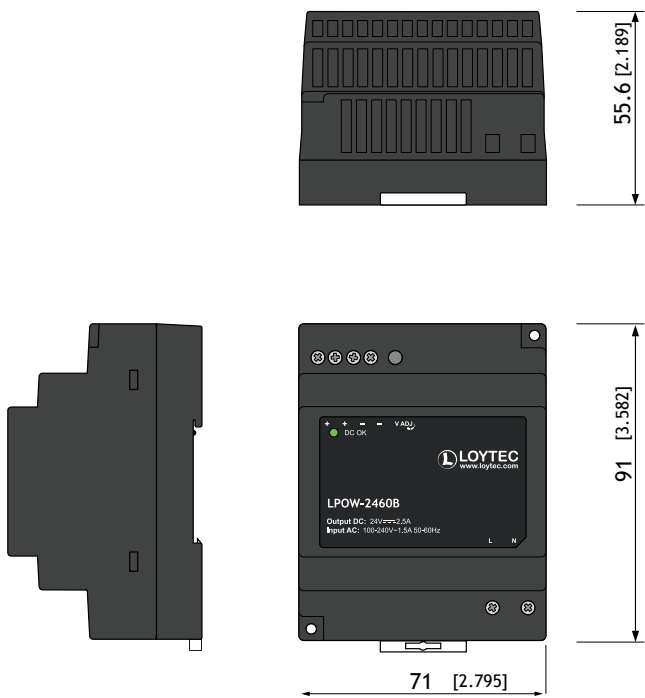

DIM051 LMPBUS-804

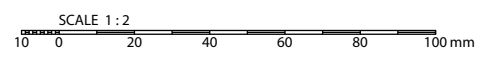
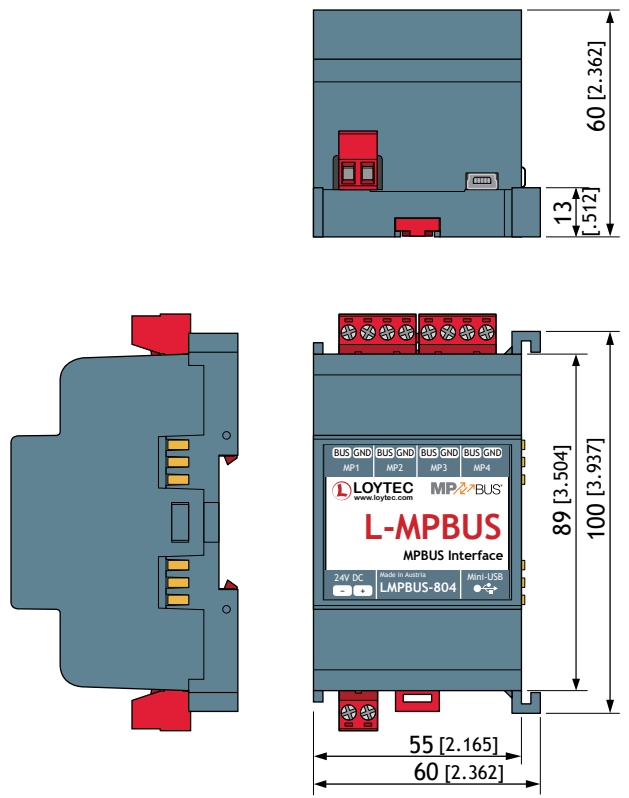

DIM052 NIC709-USB100

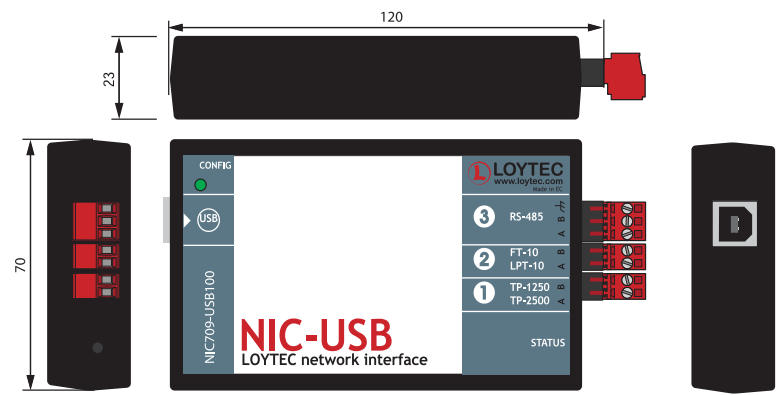

Dimensions of the devices in mm and [inch]

DIM053

LROC-102
 LINX-153
 LGATE-952

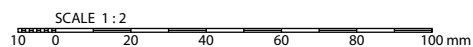
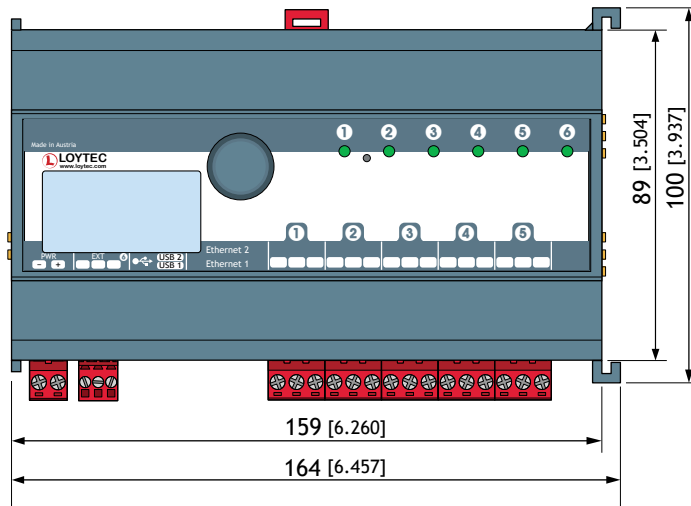
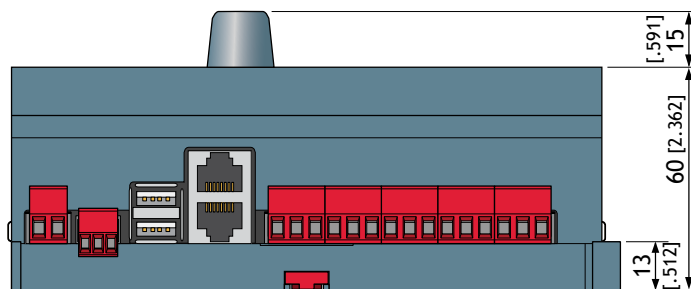
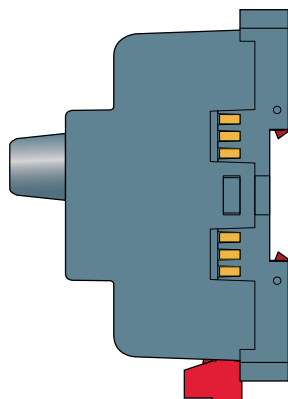

DIM054

LINX-154
 LIP-3333ECTC
 LIP-ME204C

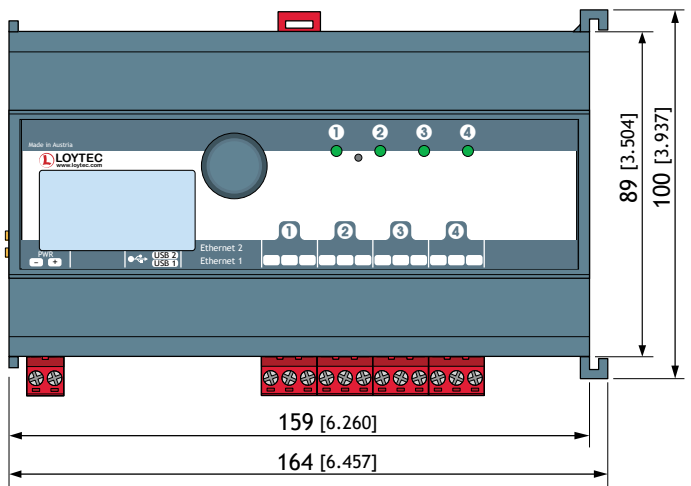
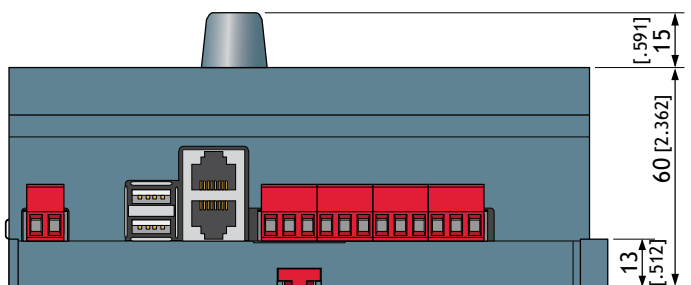
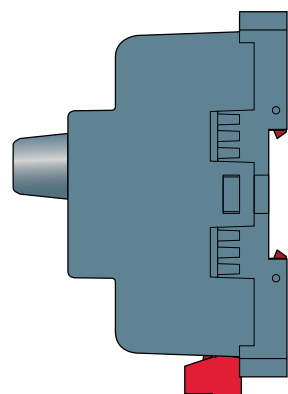

Dimensions of the devices in mm and [inch]

DIM055 LOYDVS-110W02-3SFP

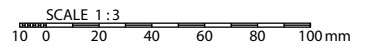
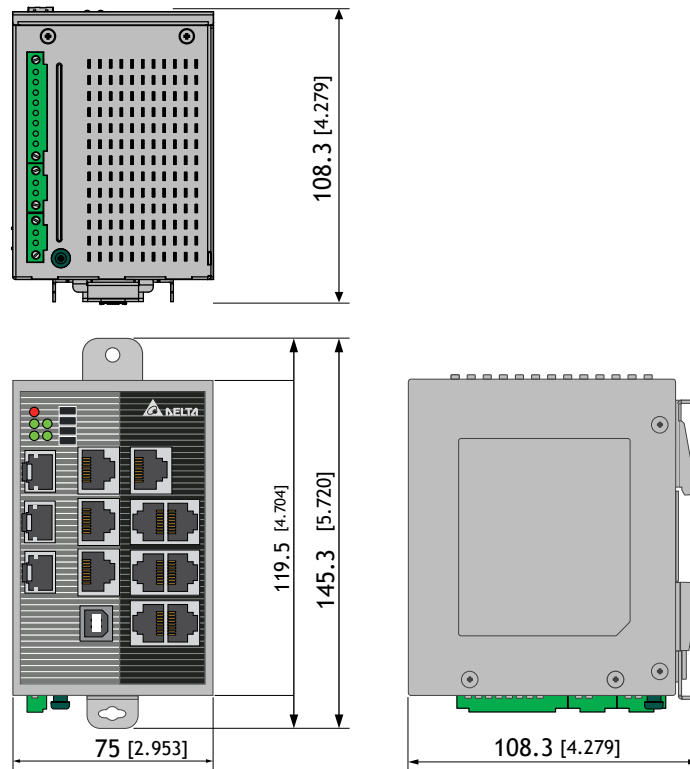

DIM056 LOYDVS-008100

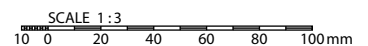
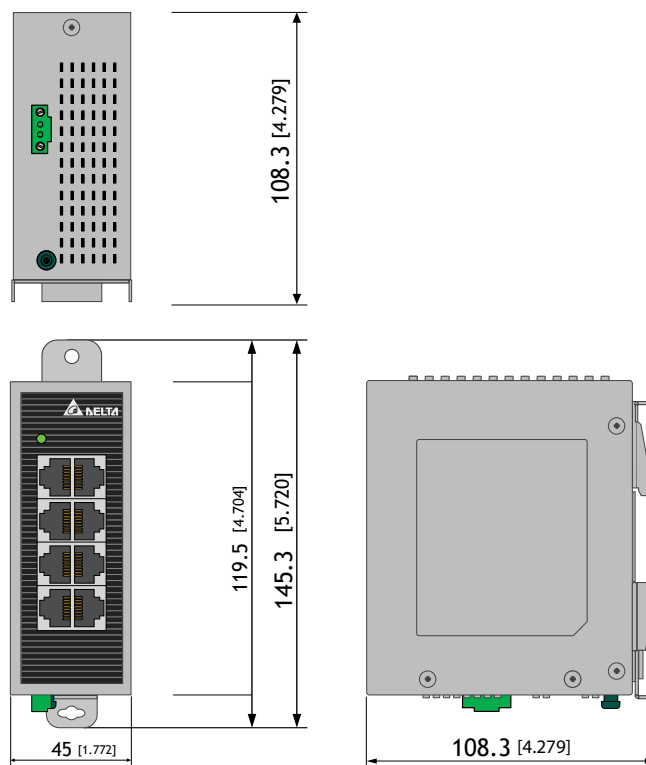

Dimensions of the devices in mm and [inch]

DIM057 LIOB-585

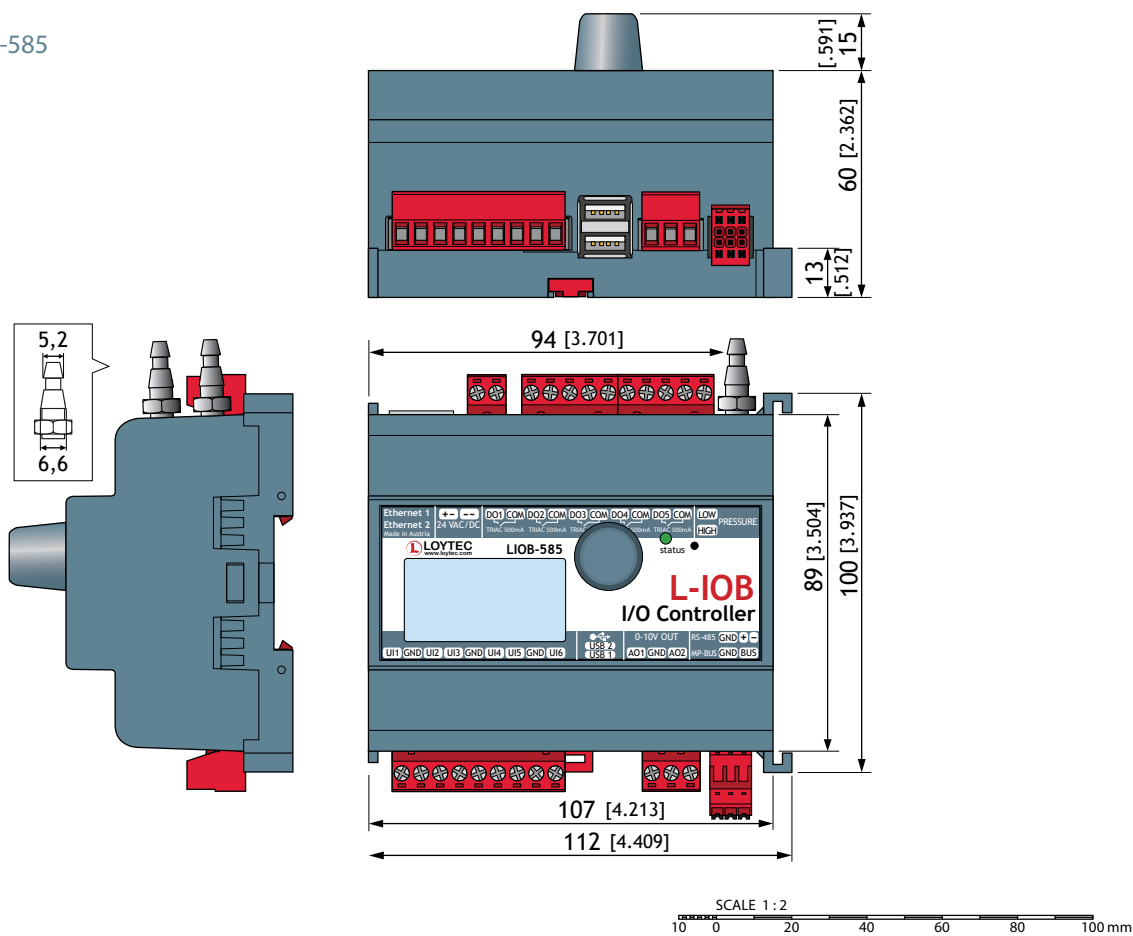

DIM058 LOYDVP16SM11N

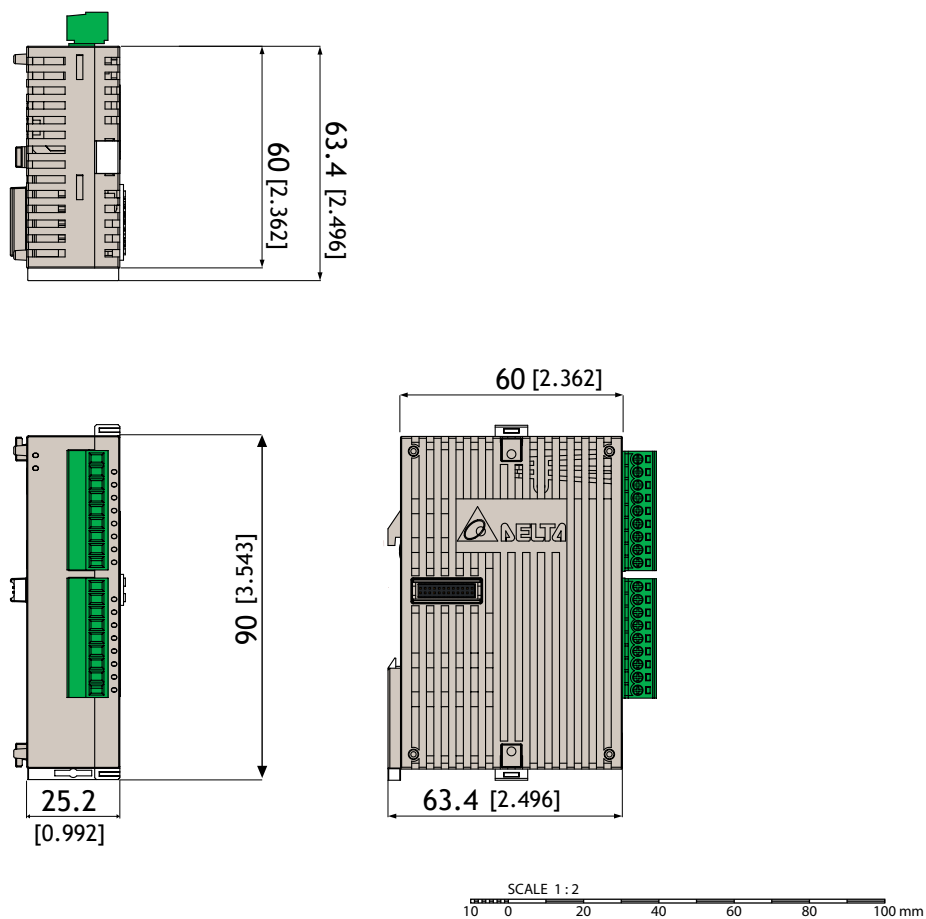

Dimensions of the devices in mm and [inch]

DIM059 LOYRTU-485

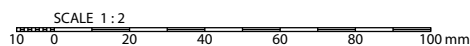
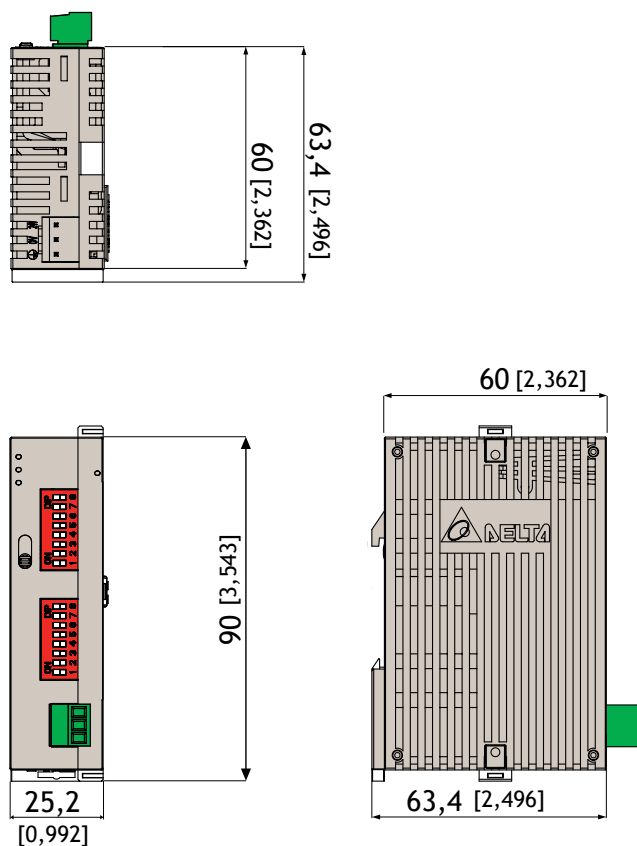

DIM060 LTE Antenna 700 - 2600 MHz

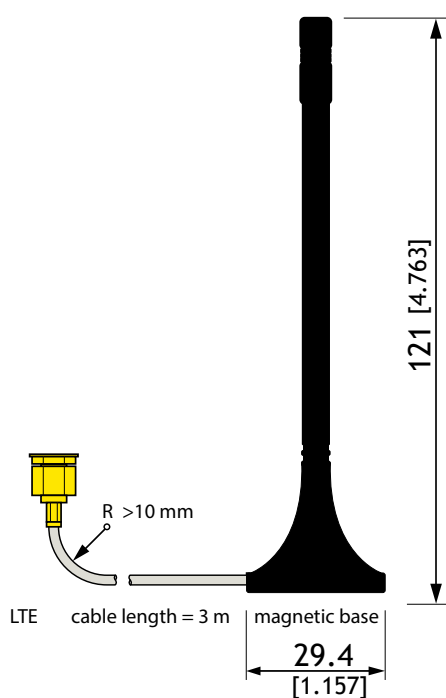

Dimensions of the devices in mm and [inch]

DIM061 LDALI-MS4-BT

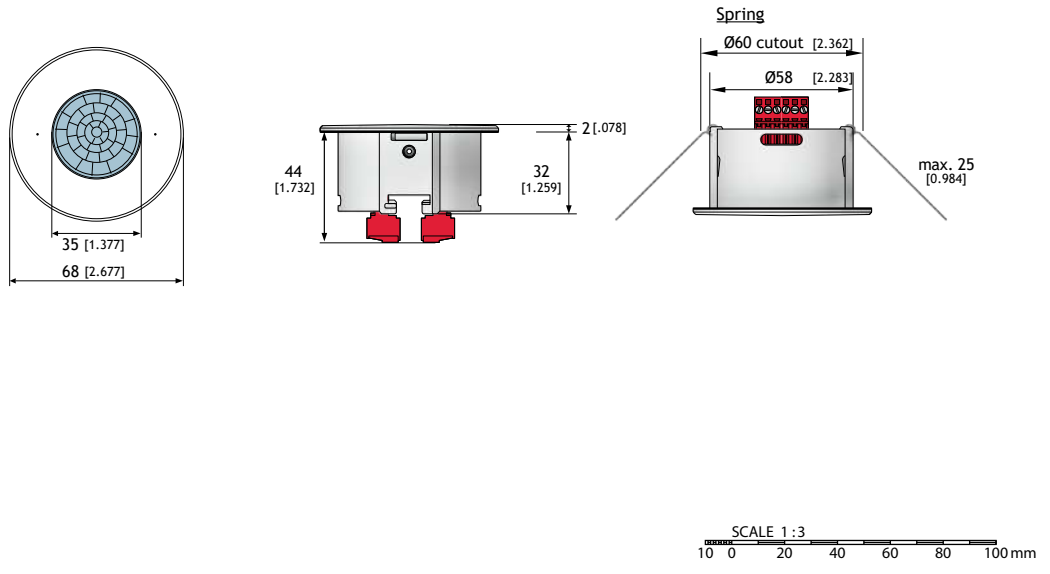

DIM062 LIOB-110

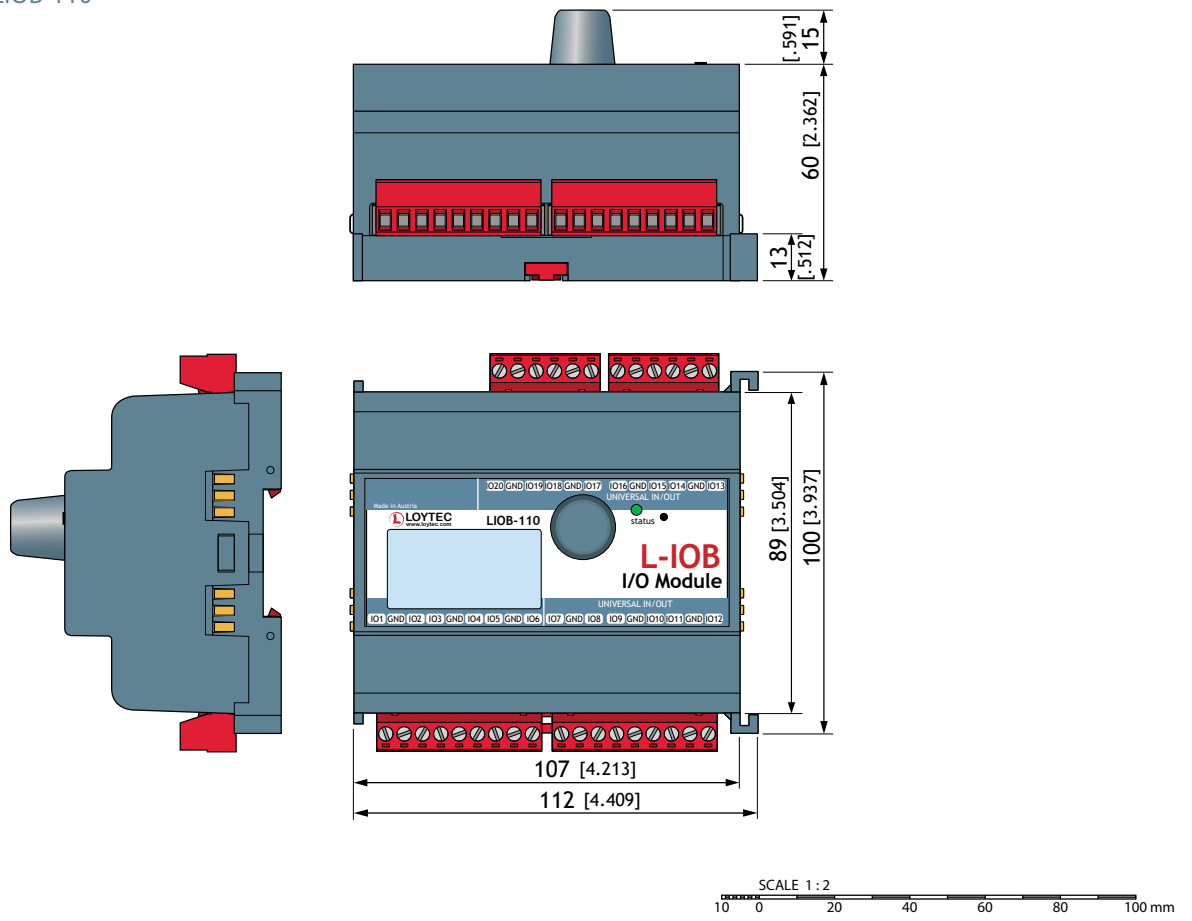

Dimensions of the devices in mm and [inch]

DIM063 LIOB-590

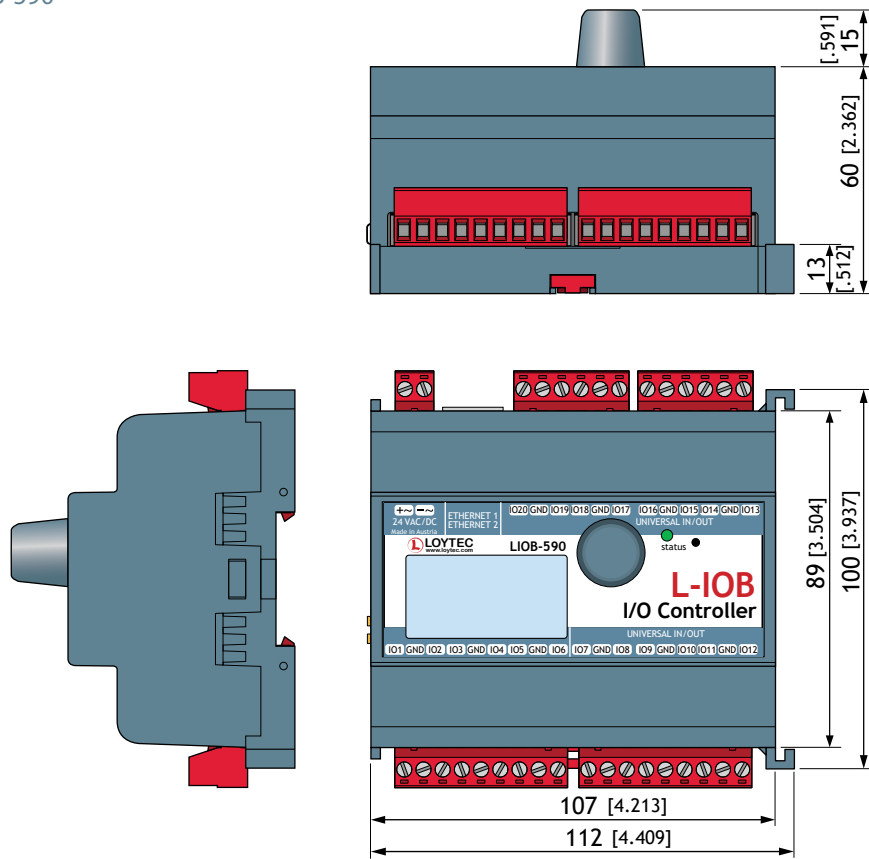

DIM064 LDALI-RM8

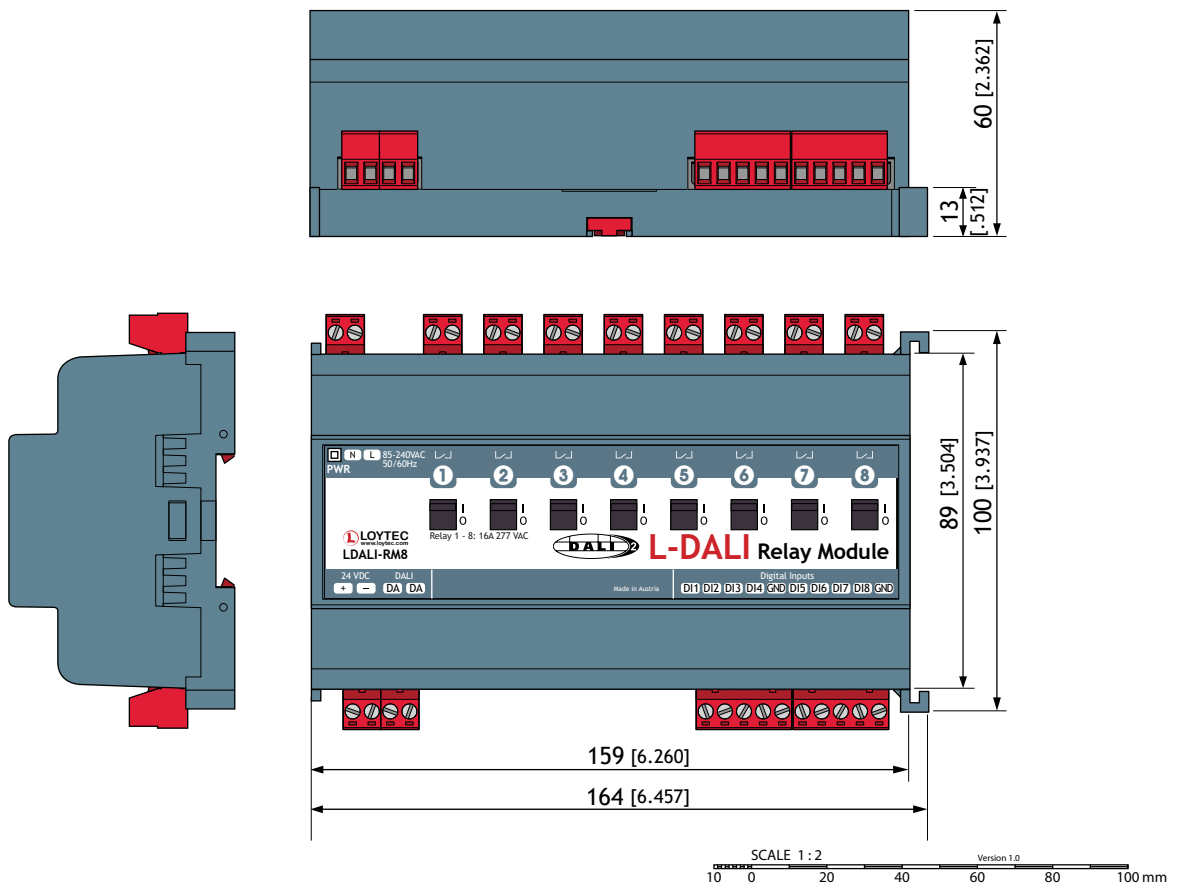

SCALE 1:2 Version 1.0
10 0 20 40 60 80 100 mm

Dimensions of the devices in mm and [inch]

DIM065 LIOB-591

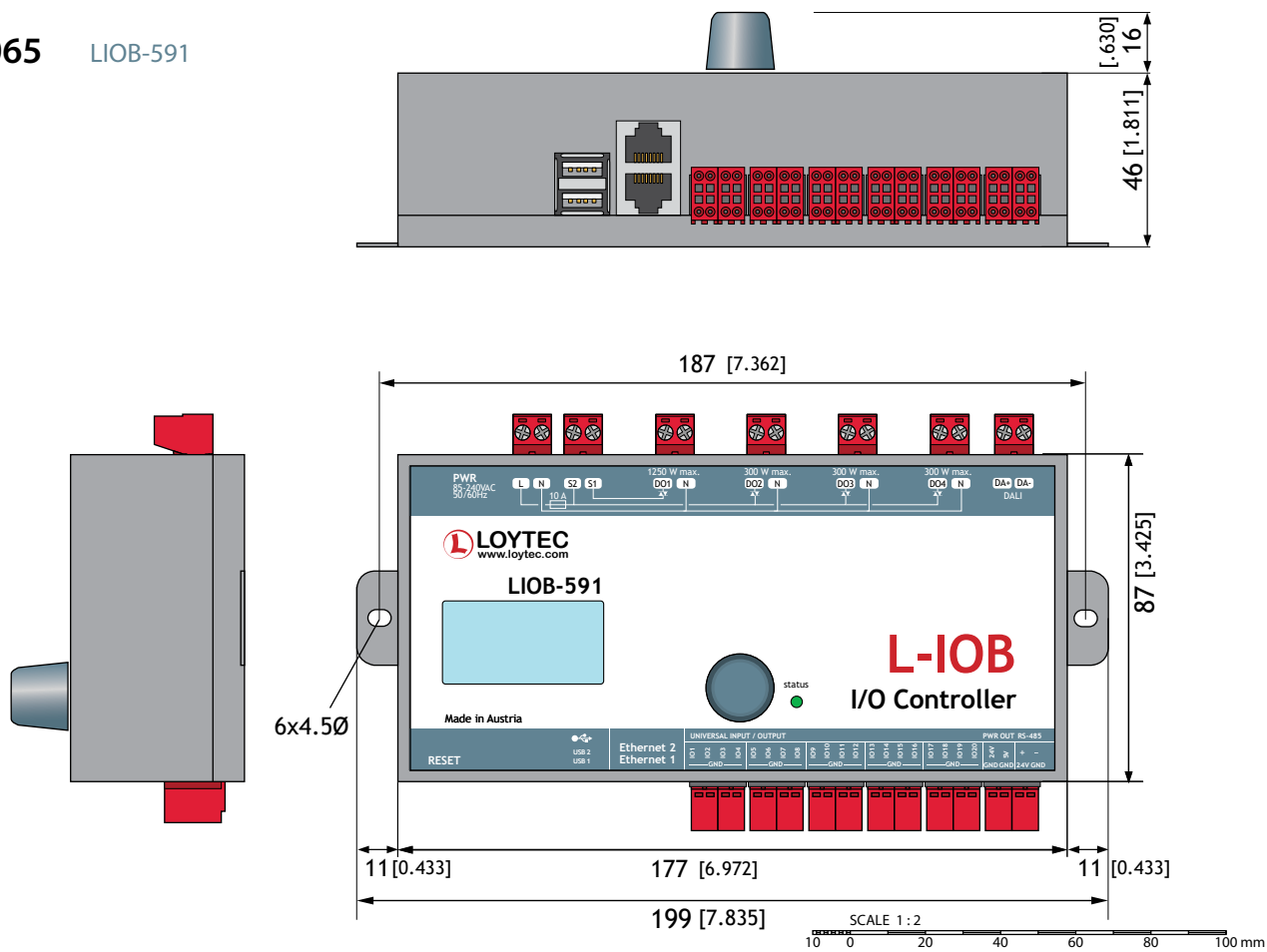

DIM066 LDALI-RM5
LDALI-RM6

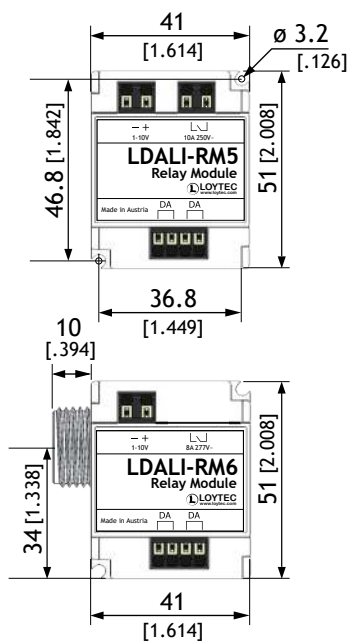

DIM067 LSTAT-810-G2-L0
LSTAT-820-G2-L0
LSTAT-830-G2-L0

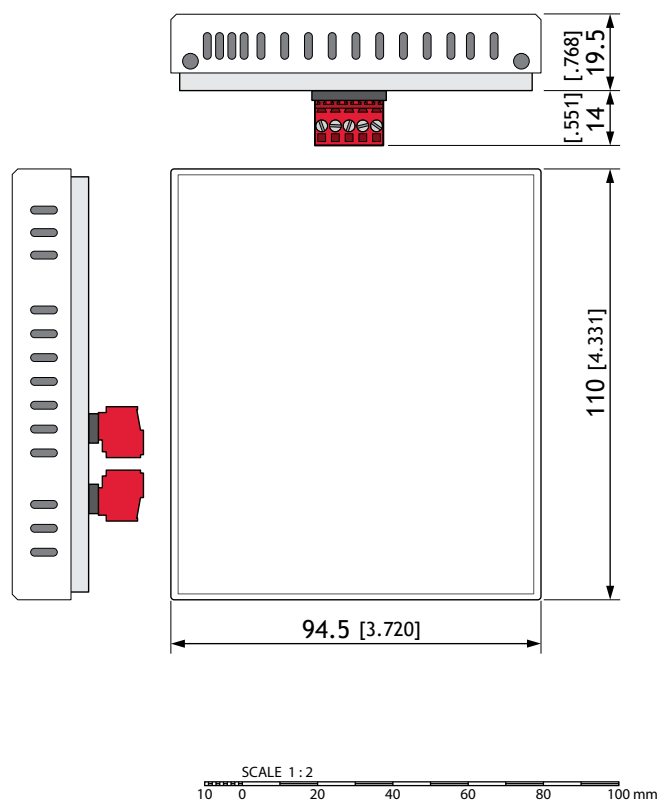

Dimensions of the devices in mm and [inch]

DIM068 LPAD-7

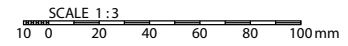
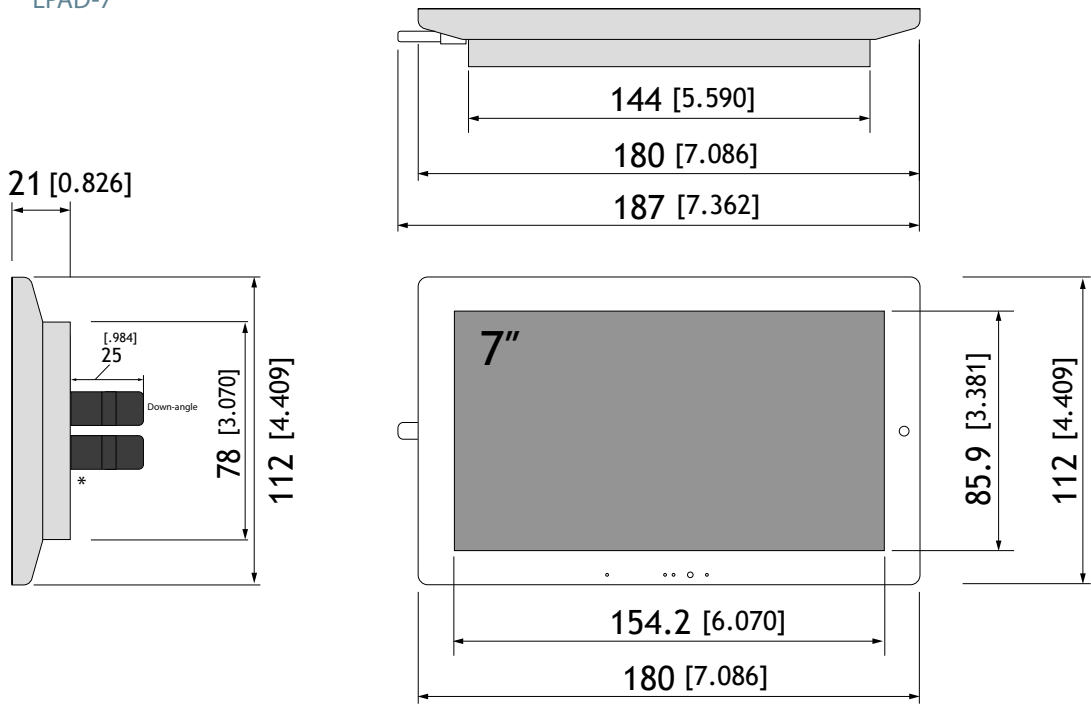

DIM069 LPAD7-SOCKET0
LPAD7-SOCKET1
LPAD7-SOCKET2
LPAD7-SOCKET3
LPAD7-SOCKET4
LPAD7-SOCKET5

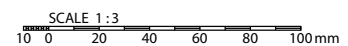
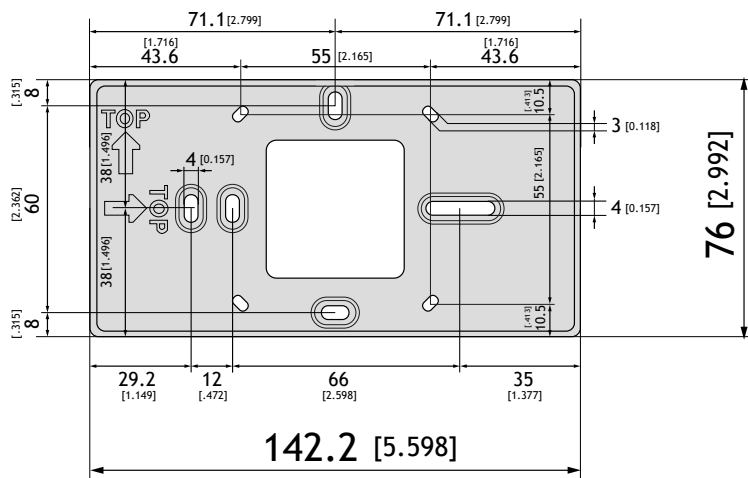

Dimensions of the devices in mm and [inch]

DIM070 LRS232-802

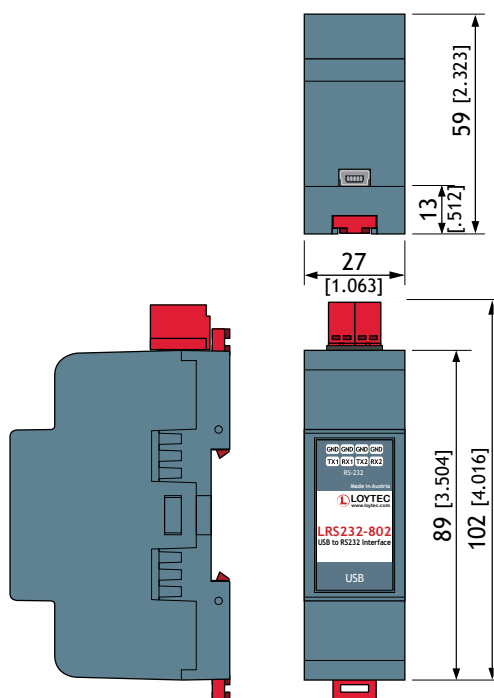

DIM72 LDALI-PWM4

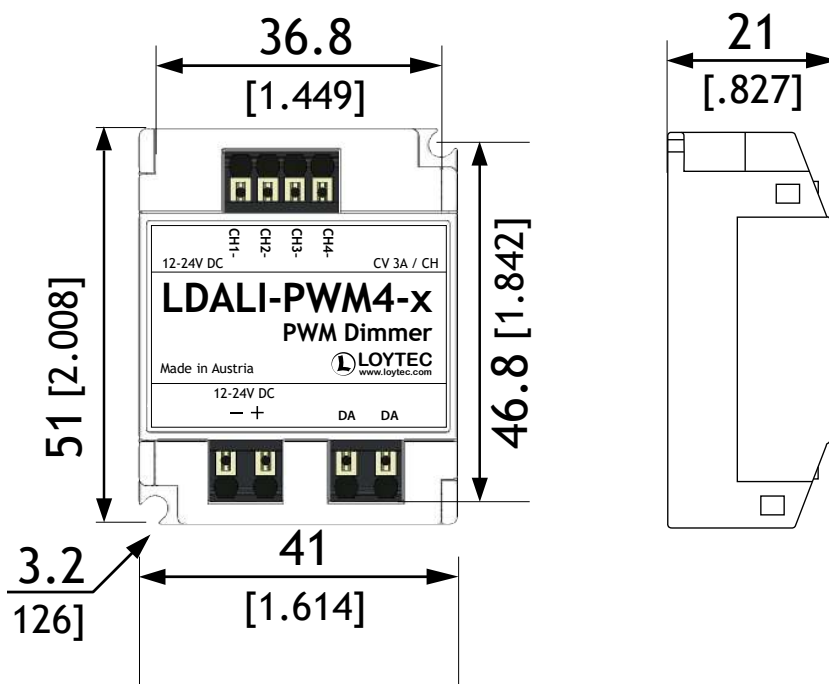

Dimensions of the devices in mm and [inch]

DIM073 LI0B-112

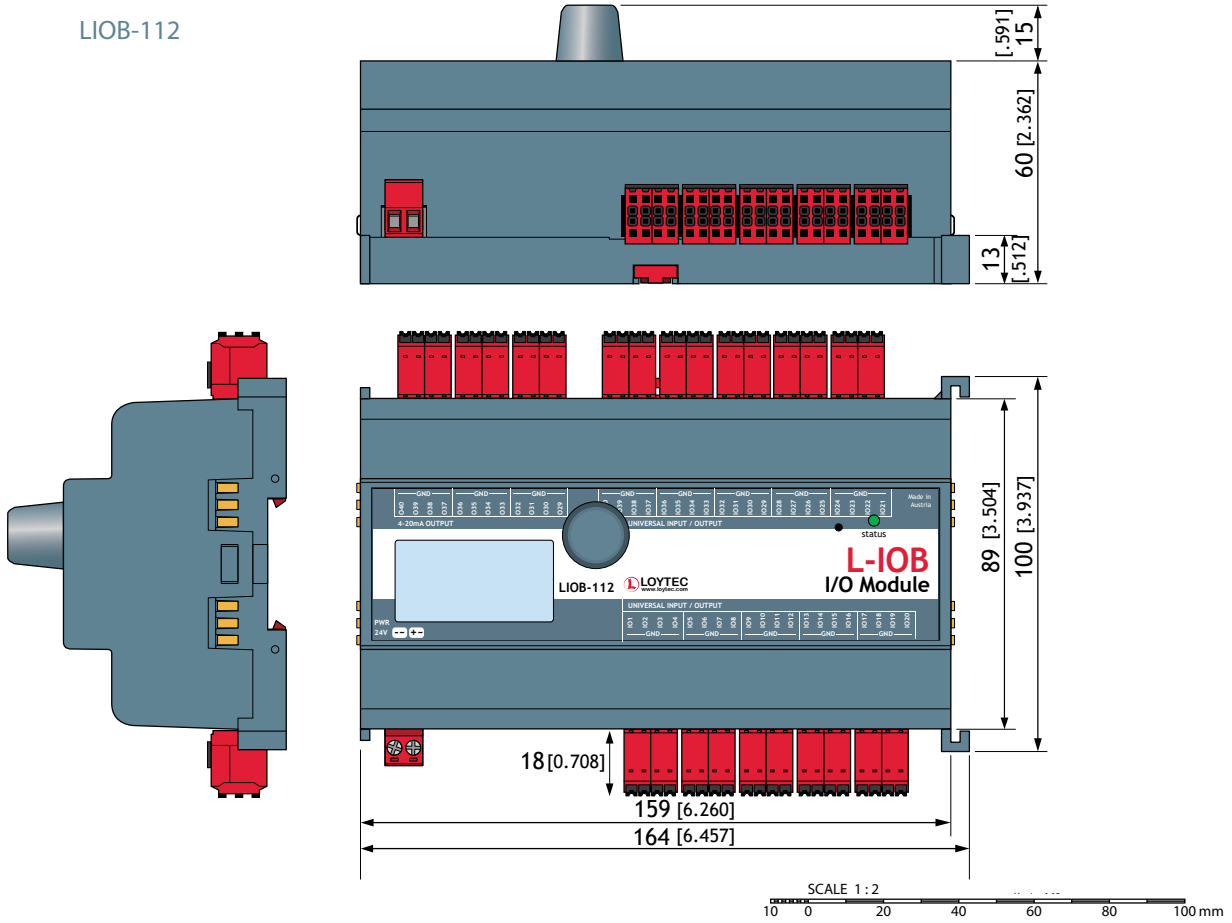

DIM074 LI0B-592

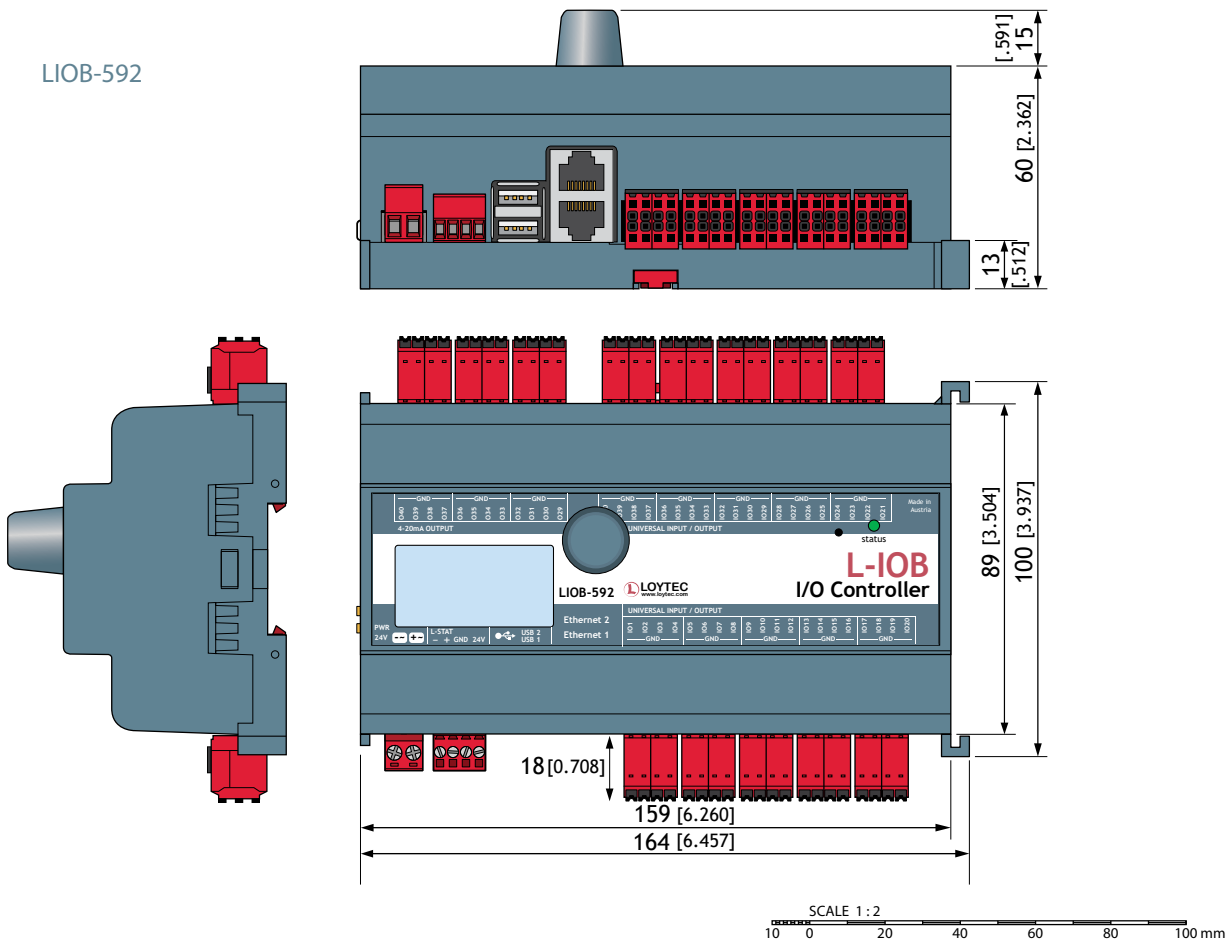

Dimensions of the devices in mm and [inch]

DIM075 LIOB-593

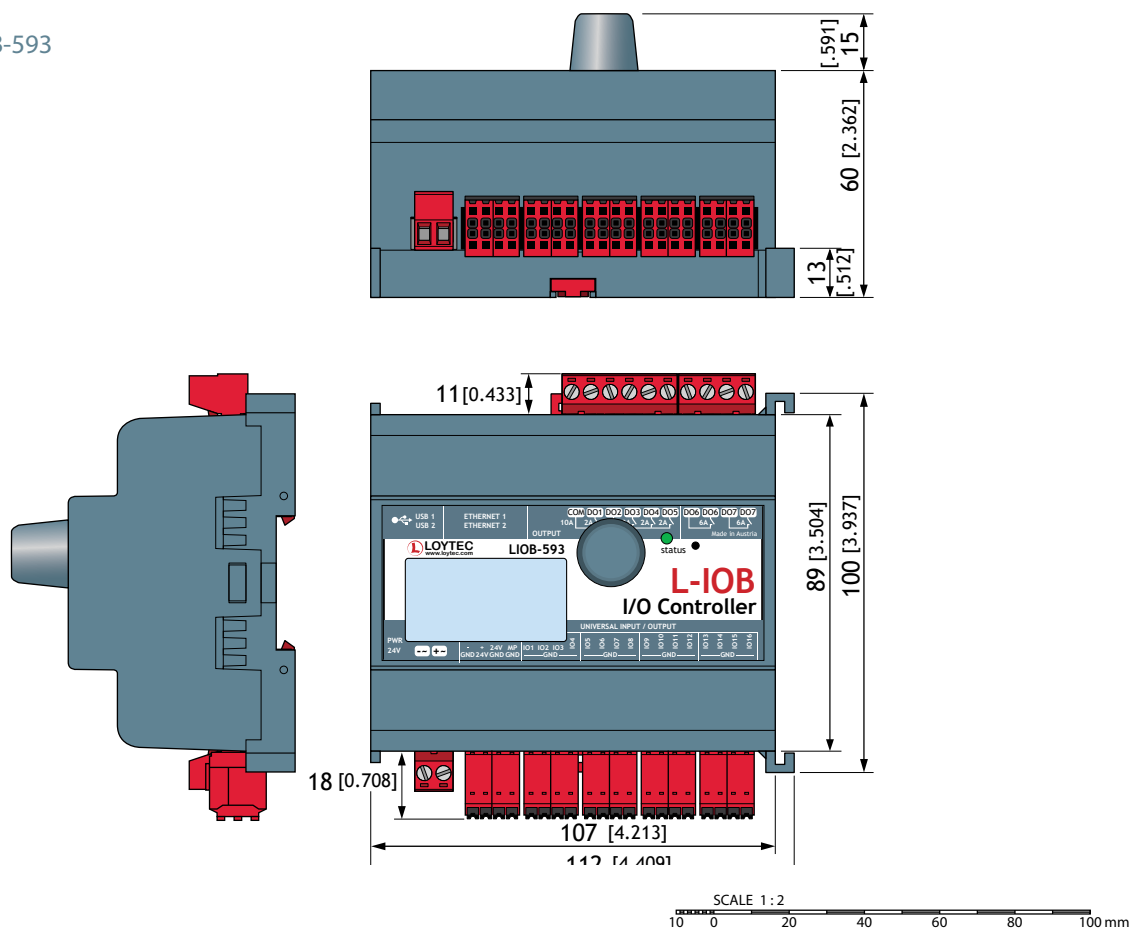

DIM076 LIOB-594

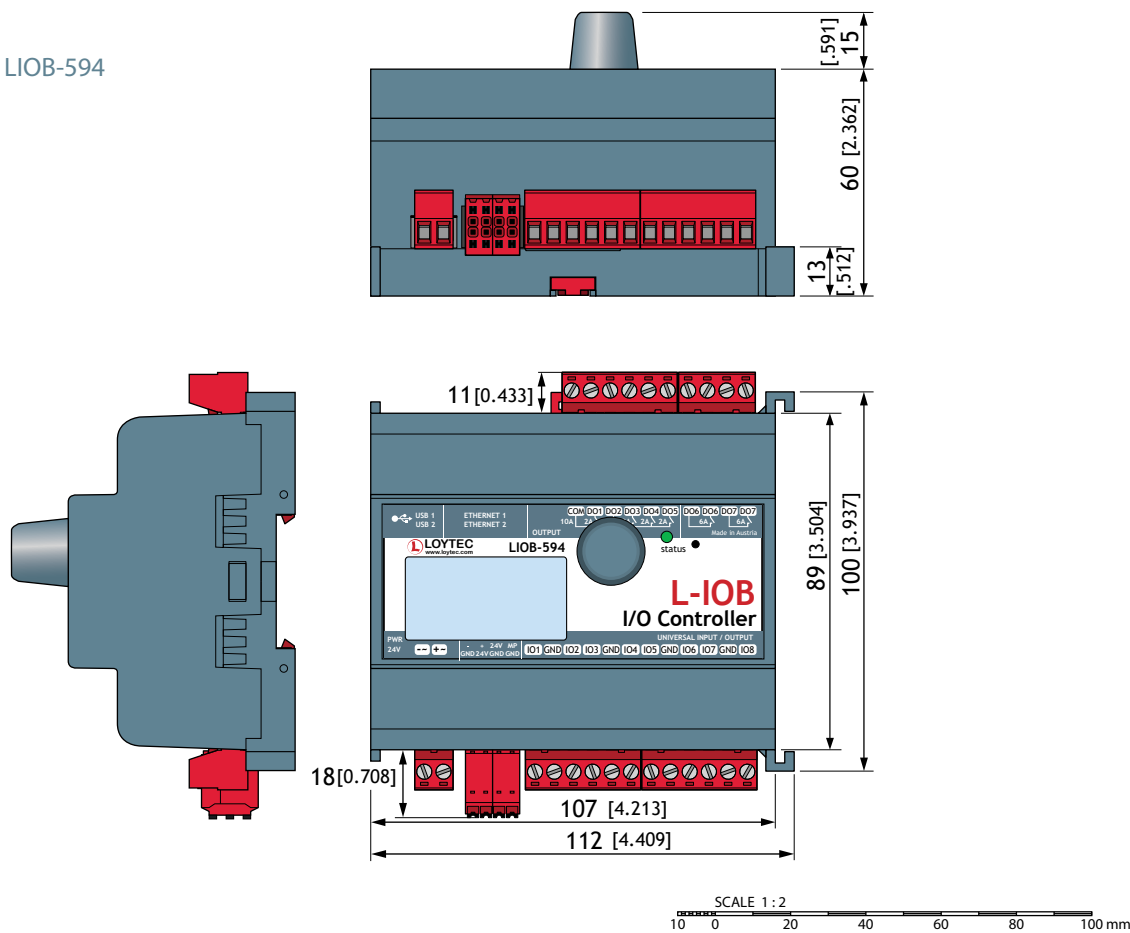

Dimensions of the devices in mm and [inch]

DIM077 LIOB-595

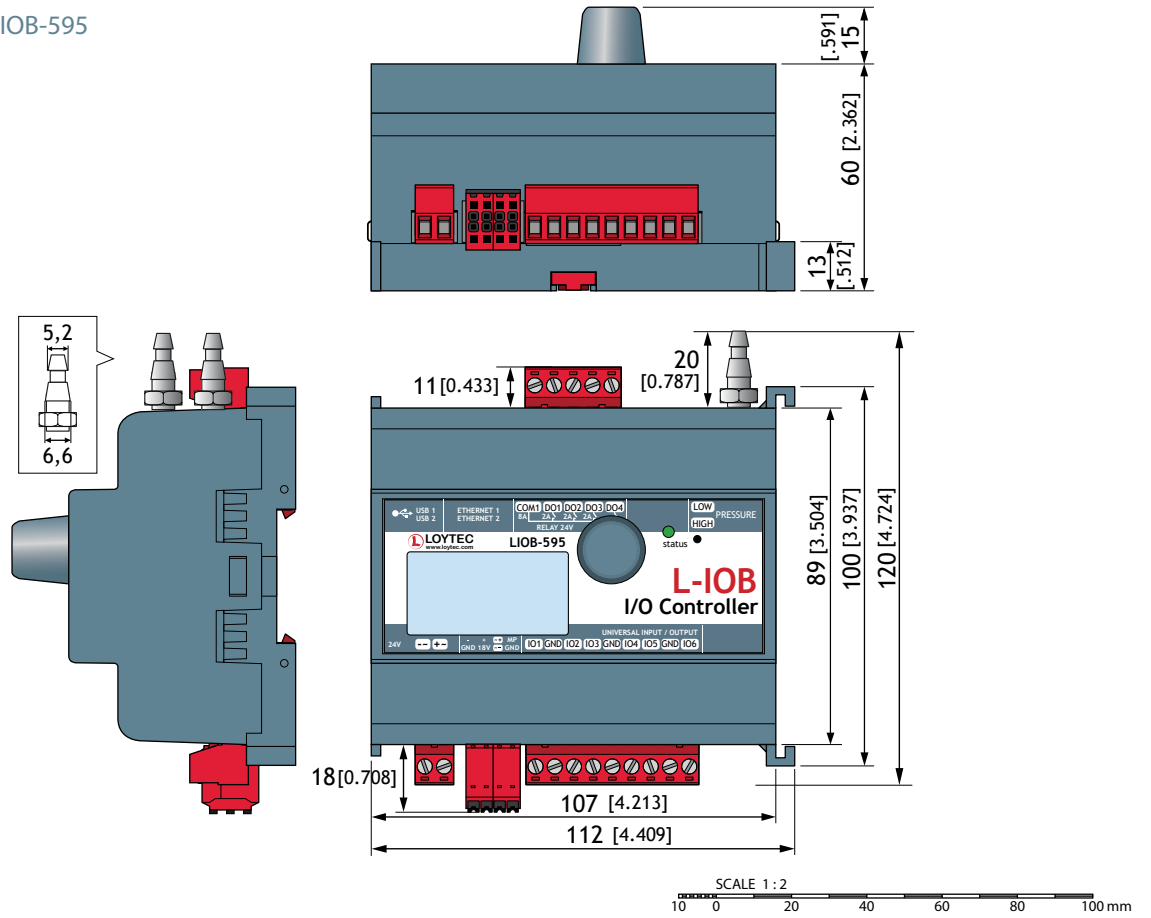

DIM078 LIOB-596

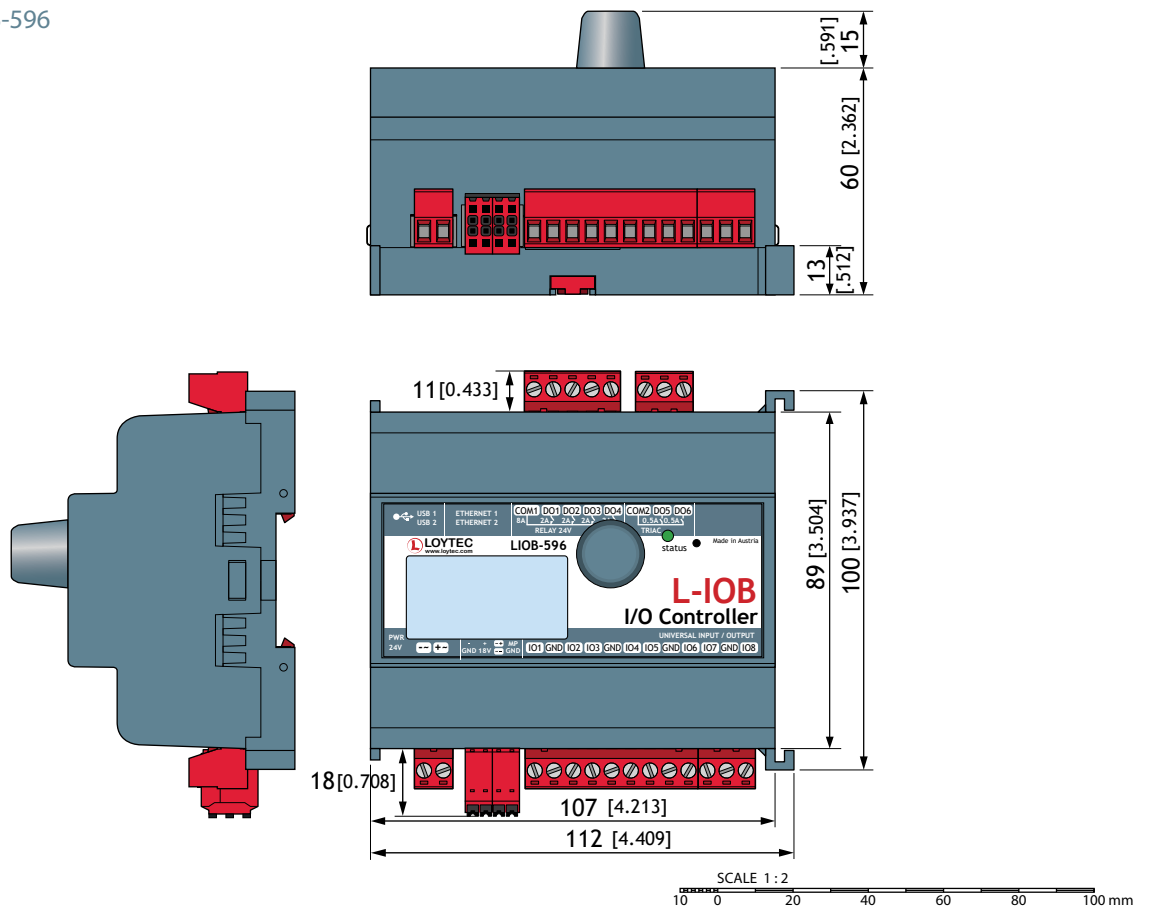

Dimensions of the devices in mm and [inch]

DIM079 LOYREL-816

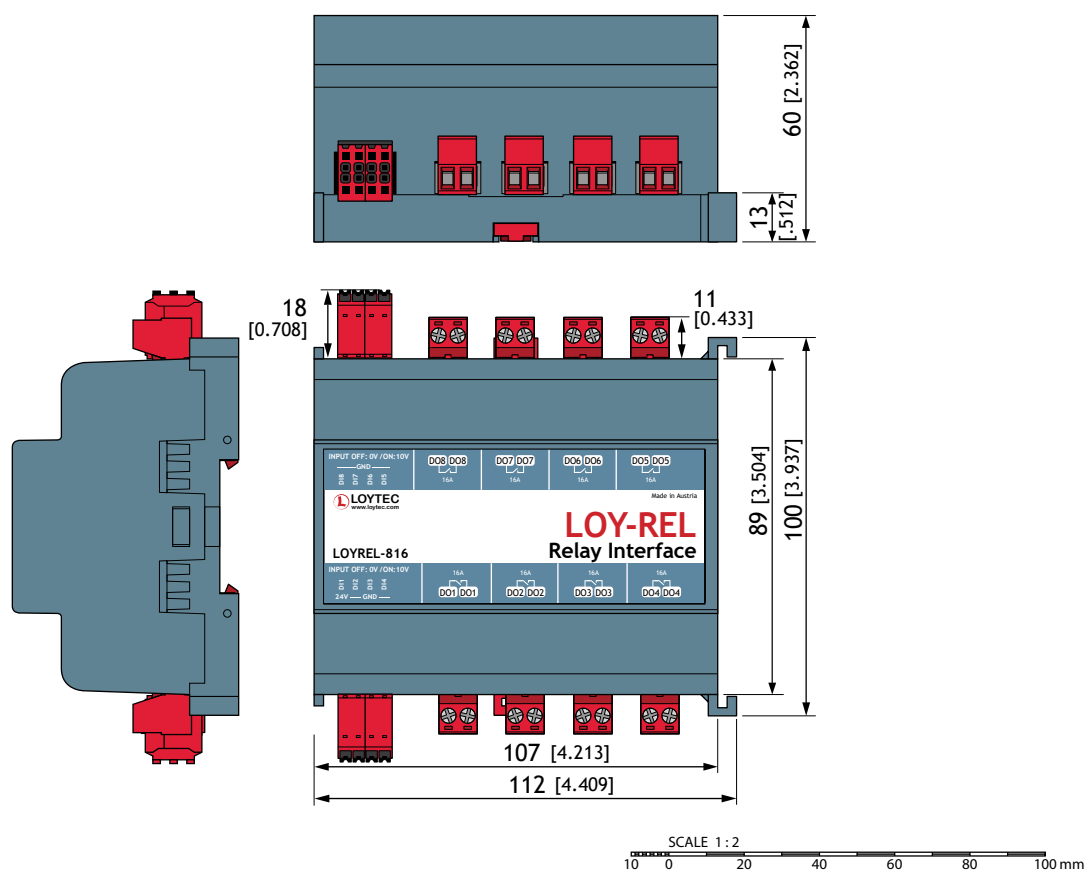

DIM080 L-TRIAC16

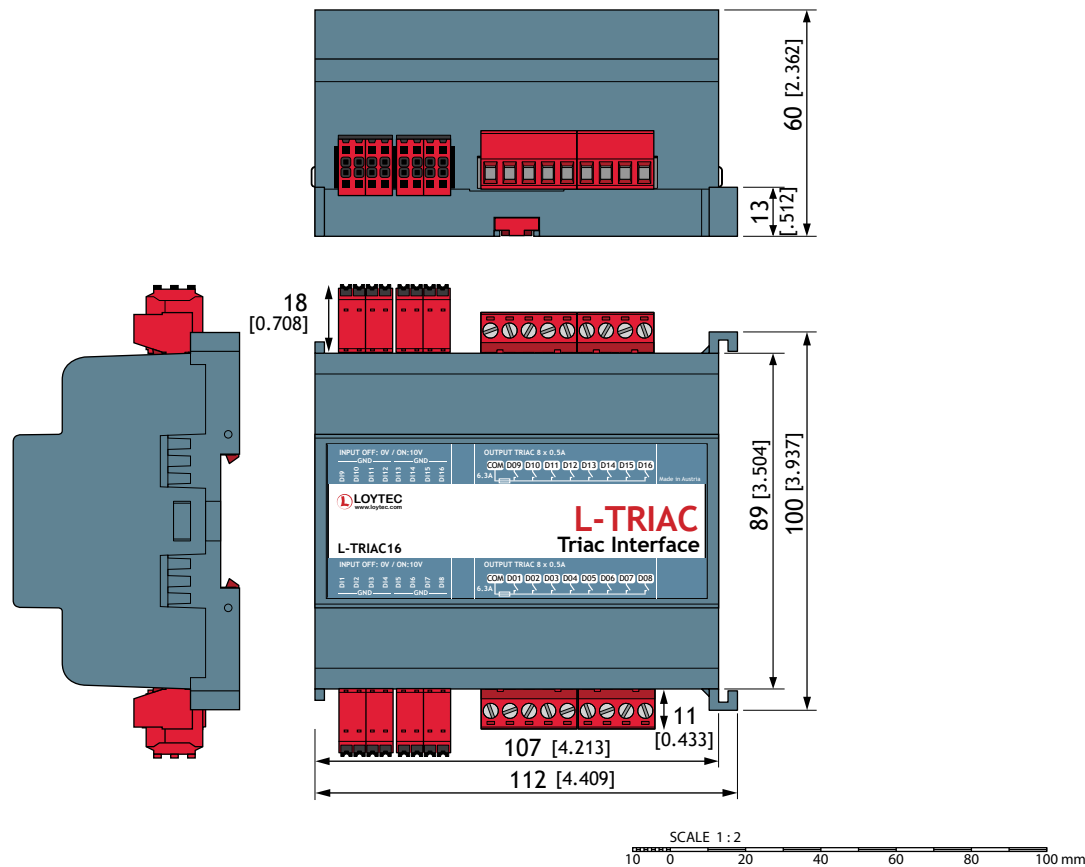

Dimensions of the devices in mm and [inch]

DIM081 LOYCNV-VA8

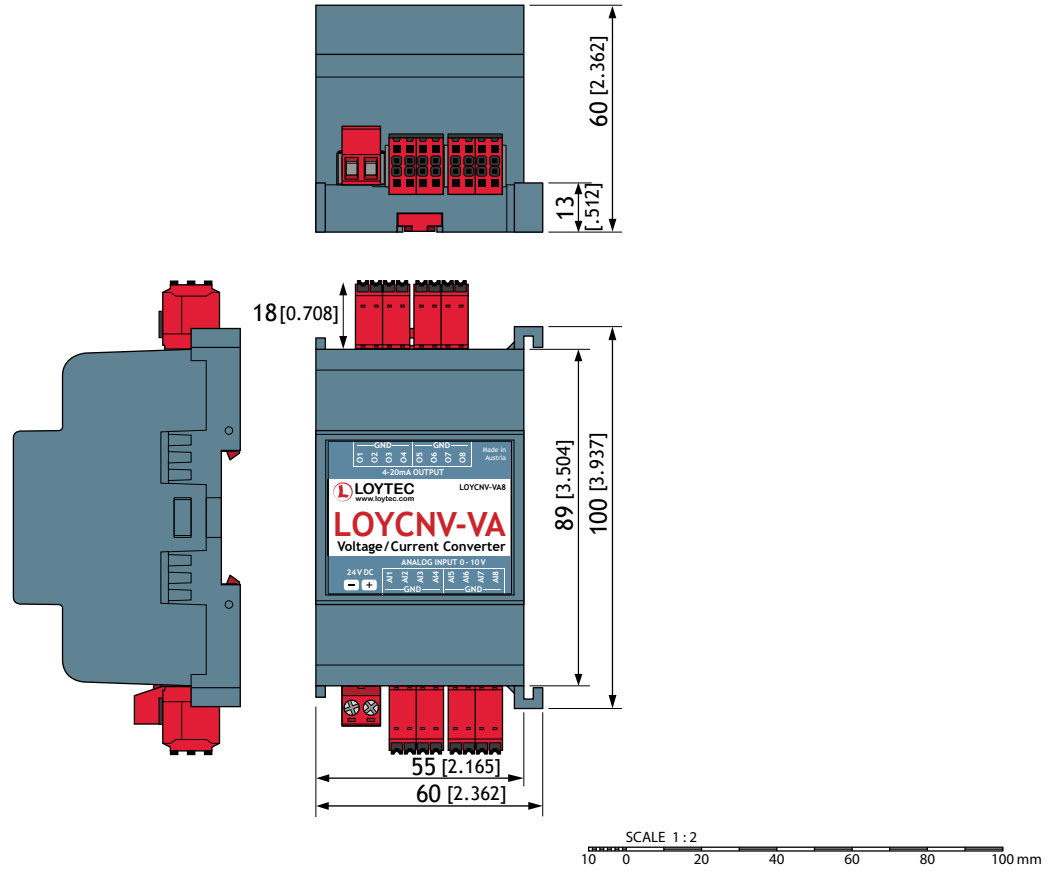

DIM082 LOYBT-TEMP1

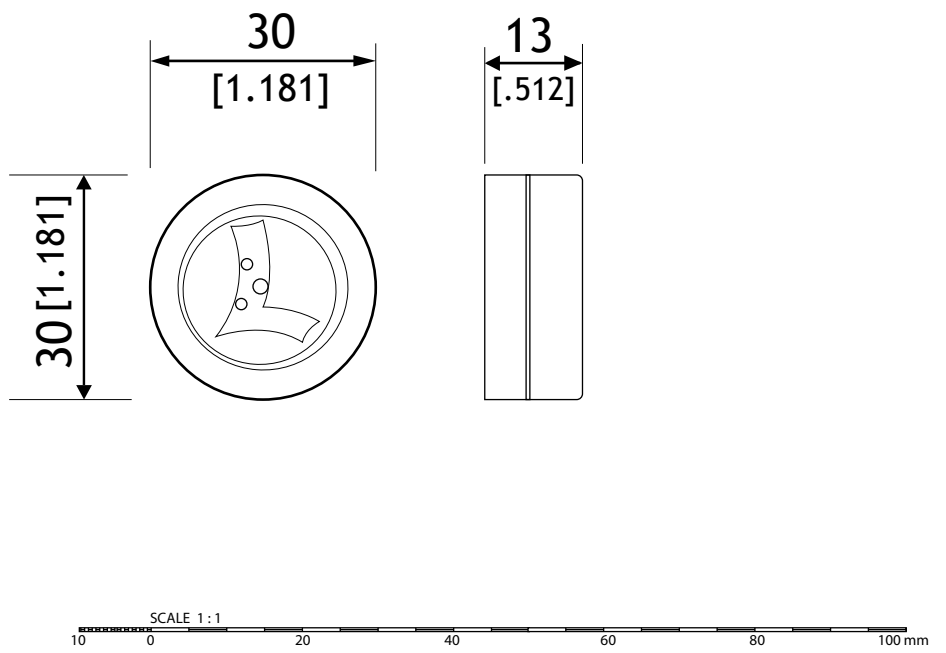

Dimensions of the devices in mm and [inch]

DIM083

LOYUNO-L

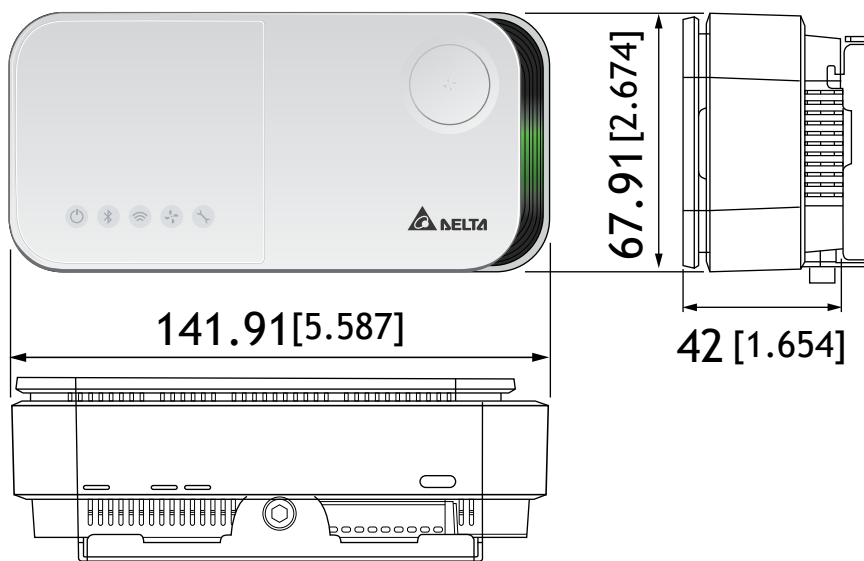

SCALE 1:2
10 0 20 40 60 80 100 mm

Functions

L-WEB, L-STUDIO

L-ROC

L-INOX

L-IOB

Gateways

LPAD-7,
L-VIS, L-STAT

L-DALI

Routers, NIC

Interfaces

Accessories

Dimensions of the devices in mm and [inch]

DIM085 LOY-DALI-SBM1

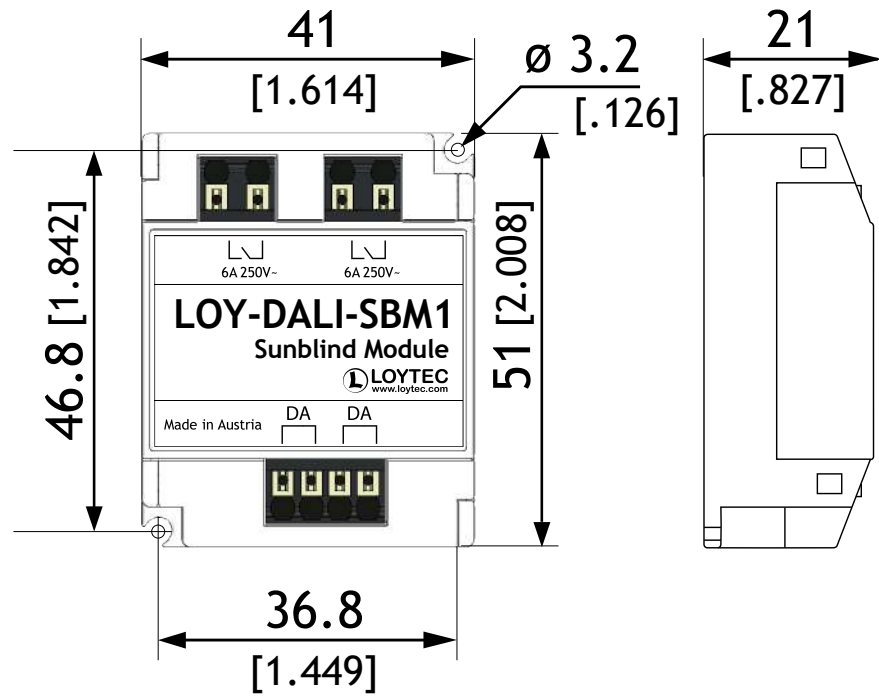

DIM086 LOYCNV-PT1008

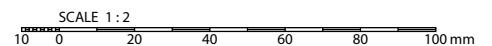
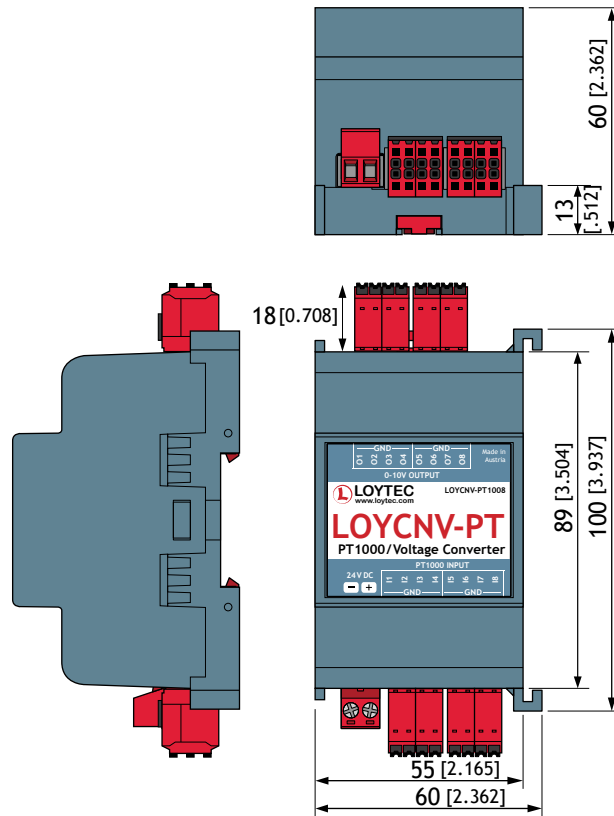

Dimensions of the devices in mm and [inch]

DIM087 LIOB-560

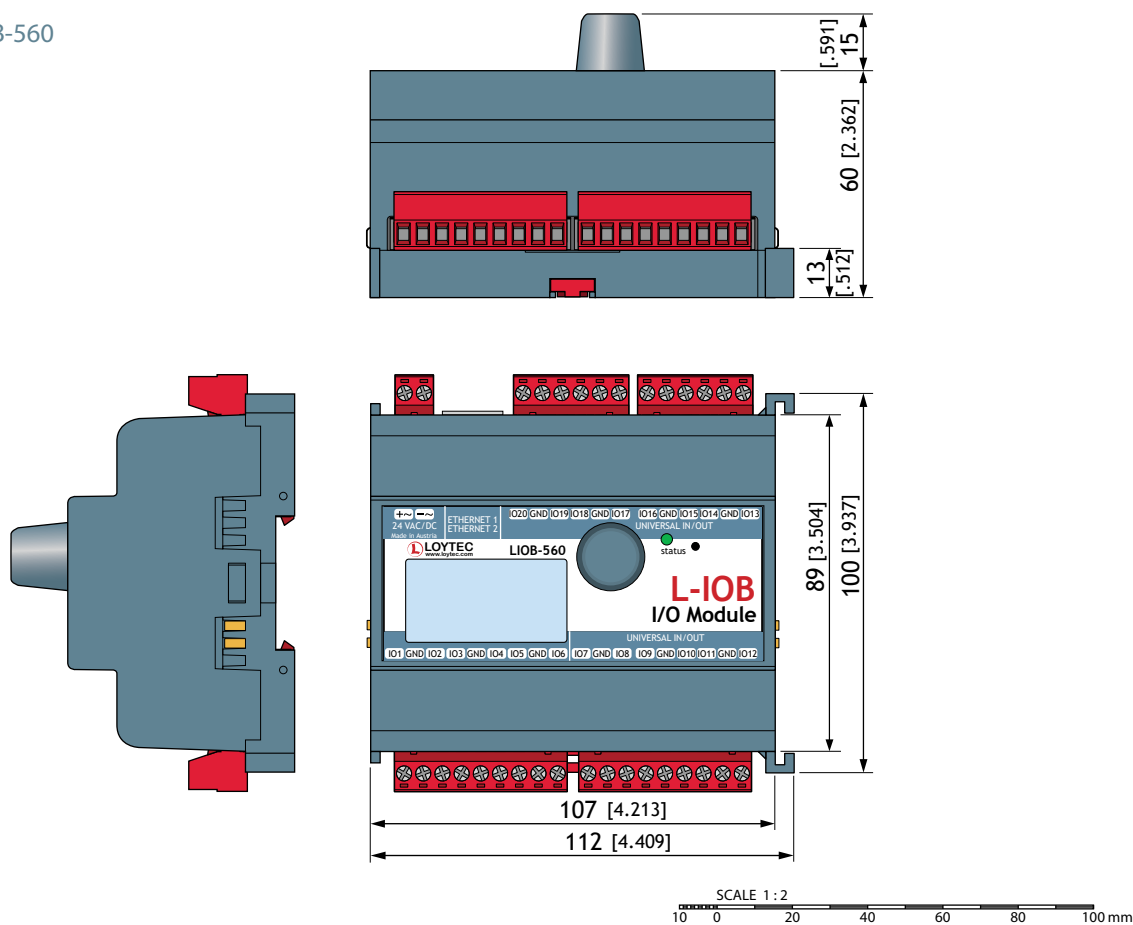

DIM088 LIOB-562

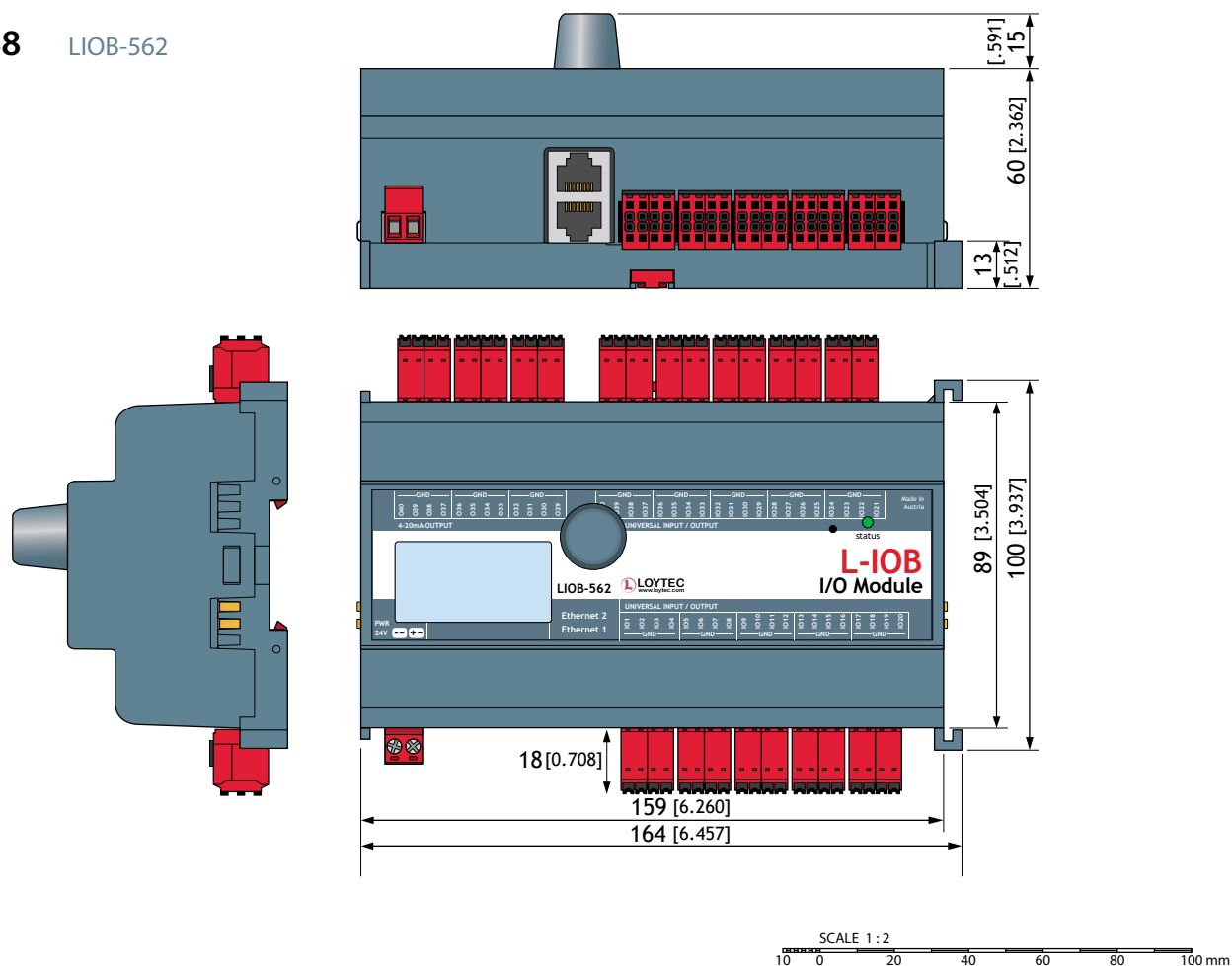

Dimensions of the devices in mm and [inch]

DIM089 LDALI-MS3-BT

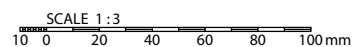
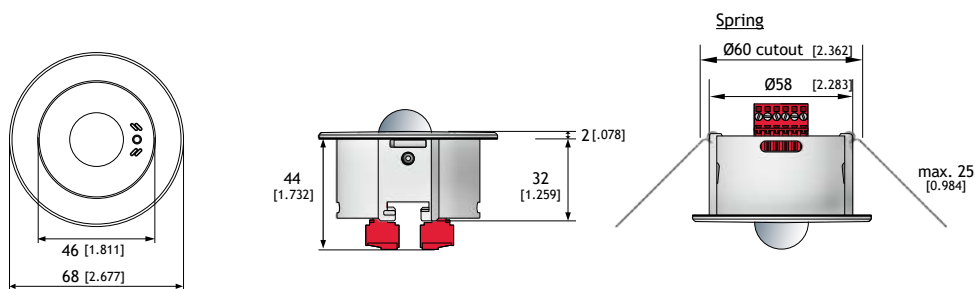



LonMark Certified Products

The L-IOB I/O Modules are officially certified as LonMark products:

- LIOB-150 LIOB-FT I/O Module



- LIOB-151, LIOB-152, and LIOB-153 LIOB-FT I/O Modules



- LIOB-154 LIOB-FT I/O Module
- LIOB-450, LIOB-451, LIOB-452, LIOB-453, and LIOB-454 LIOB-IP852 I/O Modules

Certificates

BACnet Conformance Certificates

The complete family of the BACnet enabled L-INX Automation Servers, L-GATE Gateways, L-ROC Room Controllers, L-DALI Light Controllers, and L-IP Routers are BTL tested and certified according to the standard ISO 16484-6:2021 as BACnet Building Controllers (B-BC).

- LINX-150, LINX-151, LINX-153, LINX-154, LINX-202, LINX-203, LINX-212, LINX-213, LINX-215, LINX-220, LINX-221
- LGATE-902, LGATE-950, LGATE 951, LGATE-952
- LROC-100, LROC-101, LROC-102, LROC-400, LROC-401, LROC-402
- LDALI-PLC2, LDALI-PLC4, LDALI-ME201-U, LDALI-ME204-U
- LIP-ME201C, LIPME202C, LIP-ME204, LIP-ME204C



The L-VIS Touch Panels, and BACnet enabled LPAD-7 Programmable Touch Panels are BTL tested and certified according to the standard ISO 16484-6:2021 as BACnet Building Controllers (B-BC).

- LVIS-3ME7-G1, LVIS-3ME7-G2, LVIS-3ME12-A1, LVIS-3ME15-A1, LVIS-3ME15-G1, LVIS-3ME15-G2, LVIS-3ME15-G3
- LPAD7-31G2, LPAD7-41G2, LPAD7-31G3, LPAD7-41G3



The LIOB-BIP I/O Modules LIOB-55x and the LIOB-BIP I/O Controllers LIOB-58x/59x, are BTL tested and certified according to the standard ISO 16484-6:2021 as BACnet Building Controllers (B-BC).

- LIOB-550, LIOB-551, LIOB-552, LIOB-553, LIOB-554
- LIOB-580, LIOB-581, LIOB-582, LIOB-583, LIOB-584
- LIOB-585, LIOB-586, LIOB-587, LIOB-588, LIOB-589
- LIOB-590, LIOB-591, LIOB-592, LIOB-593, LIOB-594, LIOB-595, LIOB-596



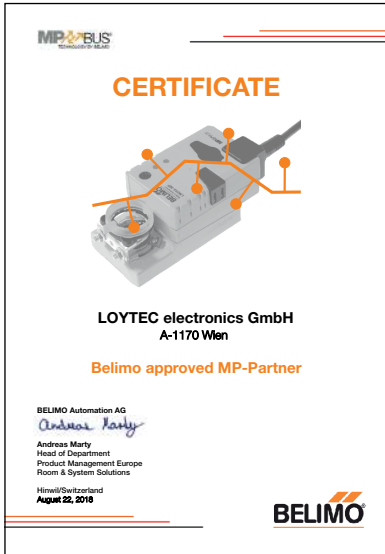

MP-Bus Certificate

LOYTEC is a Belimo approved MP-Partner and LOYTEC devices with built-in MP-Bus interface have been successfully certified.



SMI Certificate

The LSMI-800, LSMI-804 and LROC-40x are certified and registered according to the Standard Motor Interface certification process (www.standard-motor-interface.com).

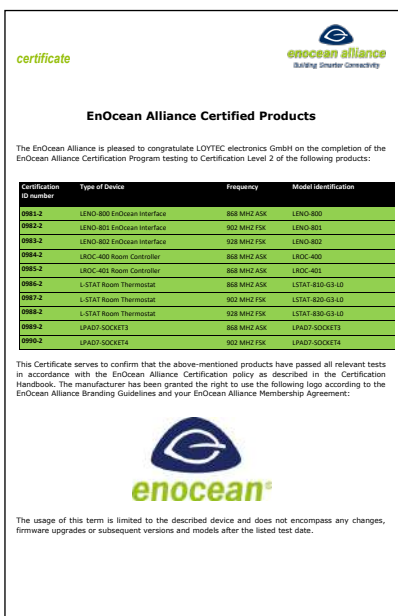

EnOcean Alliance Certificates

All LOYTEC EnOcean enabled products have been Level-2 certified by the EnOcean Alliance.

Certificates

AMEV
Arbeitskreis Maschinen- und Elektrotechnik
staatlicher und kommunaler Verwaltungen

**WSP
CERT**
BACnet ZERTIFIZIERUNGSSTELLE

AMEV attestation for certified BACnet devices

1. The following BACnet device is certified as per DIN EN ISO 16484-5:

Supplier	LOYTEC electronics GmbH	
Product name	BACnet Building Controller (L-INX, L-GATE, L-ROC, L-DALI, L-IP)	
Product model number	LINX-x, LGATE-x, LROC-x, LDALI-x, LIP-x	
Standard device profile	B-BC	BACnet protocol vers. / rev. 1.16
Firmware revision	7.6	

Data link layer options	<input checked="" type="checkbox"/> BACnet IP (Annex J)	<input type="checkbox"/> BACnet over LonTalk
	<input checked="" type="checkbox"/> BACnet MS/TP master	<input type="checkbox"/> BACnet MS/TP slave
M/STP baud rates:	<input type="checkbox"/> PTP	
	<input checked="" type="checkbox"/> Yes (for MS/TP only)	
Static device binding	<input checked="" type="checkbox"/> BBMD	<input type="checkbox"/> Reg. by foreign device
Networking options	<input checked="" type="checkbox"/> Router, medium: 9600, 19200, 38400, 57600, 76800, 115200	
Character set	<input checked="" type="checkbox"/> UTF-8	
Reporting options	<input checked="" type="checkbox"/> Intrinsic reporting	<input checked="" type="checkbox"/> Algorithmic reporting

2. The device supports BACnet functions as per AMEV profile:

<input type="checkbox"/> AMEV profile AS-A (Automation station, base version)	As of:
<input checked="" type="checkbox"/> AMEV profile AS-B (Automation station, extended version)	As of: AMEV BACnet 2017
<input type="checkbox"/> AMEV profile	As of:

3. Basis for AMEV attestation:

<input checked="" type="checkbox"/> Test report of test lab TÜV SÜD Industrie Service GmbH dated 22.12.2021 number BAC01007
<input checked="" type="checkbox"/> AMEV recommendation BACnet 2017 As of: 01.08.2017 (see www.amev-online.de)

4. The AMEV attestation is only valid in combination with the certificate:

<input checked="" type="checkbox"/> Certificate number BTL-30824-1 (see https://www.bacnetinternational.net/btl)

Cologne, 02.05.2022

B.H.L.

Dr. Ing. (FH) Elke Hruak
Geschäftsbereich der Stadt Köln
Ordnung 1
50678 Köln
Tel: +49 221 221 23405
Email: Elke.Hruak@stadt-koeln.de

.....
(AMEV chairman BACnet)

J.B.H.

**WSP
CERT**
Dr. Ing. Paul R. Bömer
Kölnstr. 7
50931 Köln
02131 41111

.....
(BACnet certification body)

AMEV Self-declarations

The German study group of public and municipal administrations for machines and electrical facilities in buildings (AMEV) presents the AMEV profiles A and B presenting the recommended minimum feature set of BACnet devices regarding object types, services, etc. With the AMEV attestations, a BTL test laboratory can certify the AMEV profile of a certified BACnet device. A selection of BACnet compliant L-IOB I/O controllers and modules, L-INX automation servers and L-GATE gateways meets the AMEV profile AS-B according to BACnet 2017.

Government Certified

We are proud to be licensed to carry the Austrian coat of arms for all business matters. This certificate is granted by the ministry of economics to companies with exceptional achievements for the Austrian industry and their nationwide prominent role within their market segment.



UL Certificate

The LOYTEC products listed on the certificates are certified and registered according to the UL certification process.

CERTIFICATE OF COMPLIANCE

Certificate Number: 20160820-E475420
Report Reference: E475420-20160727
Issue Date: 2016-AUGUST-03

Issued to: LOYTEC electronics GmbH
Blumengasse 35
1170 Wien AUSTRIA

This is to certify that representative samples of MISCELLANEOUS CONTROLS
LVIS-3ME7-G1, LVIS-3ME7-G2, LVIS-3ME12-A1,
LVIS-3ME15-A1, LVIS-3ME15-G1, LVIS-3ME15-G2,
LVIS-3ME15-G3

LSTAT-80x-y-Lz where x can be 0 or 1 or 2, y can be 01 or 02 or 03 and z can be any digit from 1 to 9

Have been investigated by UL in accordance with the Standard(s) indicated on this Certificate.

Standard(s) for Safety: UL 86730-1 - AUTOMATIC ELECTRICAL CONTROLS FOR HOUSEHOLD AND SIMILAR USE - PART 1: GENERAL REQUIREMENTS.
CSA E60730-1:13 - AUTOMATIC ELECTRICAL CONTROLS FOR HOUSEHOLD AND SIMILAR USE - PART 1: GENERAL REQUIREMENTS.

Additional information: See the UL Online Certifications Directory at www.ul.com/directory for additional information.

Only those products bearing the UL Certification Mark should be considered as being covered by UL's Certification and Follow-Up Service.

Look for the UL Certification Mark on the product.



Page 1 of 1

CERTIFICATE OF COMPLIANCE

Certificate Number: 20161025-E475420
Report Reference: E475420-20160728
Issue Date: 2016-OCTOBER-25

Issued to: LOYTEC Electronics GmbH
Blumengasse 35
1170 Wien AUSTRIA

This is to certify that representative samples of COMPONENT - MISCELLANEOUS CONTROLS
See Addendum Page

Have been investigated by UL in accordance with the Standard(s) indicated on this Certificate.

Standard(s) for Safety: UL 86730-1 and CSA E60730-1:13. AUTOMATIC ELECTRICAL CONTROLS FOR HOUSEHOLD AND SIMILAR USE - PART 1: GENERAL REQUIREMENTS

Additional information: See the UL Online Certifications Directory at www.ul.com/directory for additional information.

Only those products bearing the UL Certification Mark should be considered as being covered by UL's Certification and Follow-Up Service.

The UL Recognized Component Mark generally consists of the manufacturer's identification and listing number, model number or other product designation as specified under "Marking" for the particular Recognition as indicated in the appropriate UL Directory. As a supplementary means of identifying products that have been produced under UL's Component Recognition Program, UL's Recognized Component Mark may be used in conjunction with the required Recognition Mark. The Recognized Component Mark is required when specified in the UL Directory preceding the recognitions or under "Marking" for the individual recognitions.

Recognized components are incomplete in certain constructional features or restricted in performance capabilities and are intended for use as components of complete equipment submitted for investigation rather than for direct installation in the field. The final acceptance of the component is dependent upon its installation and use in complete equipment submitted to UL LLC.

Look for the UL Certification Mark on the product.



Page 1 of 2

CERTIFICATE OF COMPLIANCE

Certificate Number: 20161025-E475420
Report Reference: E475420-20160728
Issue Date: 2016-OCTOBER-25

This is to certify that representative samples of the product as specified on this certificate were tested according to the current UL requirements.

Model:
LIP-3ECTB, LIP-3ECTB, LIP-3ECTC, LIP-3ECTC, LIP-303ECTB, LIP-ME301, LIP-3ECTC,
LIP-303ECTC, LIP-ME300C, LIP-ME300C, LIP-ME304

LINK-102, LINK-101, LINK-110, LINK-111, LINK-200, LINK-201, LINK-210, LINK-211, LINK-102,
LINK-103, LINK-104, LINK-105, LINK-200, LINK-201, LINK-210, LINK-211, LINK-210, LINK-102,
LINK-121, LINK-220, LINK-221, LINK-150, LINK-151

LROC-100, LROC-101, LROC-400, LROC-401, LROC-402

LGATE-800, LGATE-802, LGATE-800, LGATE-801

LOB-100, LOB-101, LOB-102, LOB-103, LOB-102, LOB-101, LOB-102, LOB-103, LOB-104,
LOB-105, LOB-101, LOB-102, LOB-103, LOB-104, LOB-400, LOB-401, LOB-402, LOB-403,
LOB-404, LOB-403, LOB-401, LOB-402, LOB-403, LOB-404, LOB-400, LOB-401, LOB-402,
LOB-500, LOB-504, LOB-500, LOB-501, LOB-502, LOB-503, LOB-504

LOD-401, LOD-402

LPDW-2415A, LPDW-2415B

LDAL-IPWR1, LDAL-IPWR1, LDAL-ETD1-U, LDAL-ETD1-U, LDAL-3ETD4-U, LDAL-3ETD4-U,
LDAL-3ETD4-U, LDAL-3ETD4-U, LDAL-3ETD4-U, LDAL-3ETD4-U, LDAL-3ETD4-U, LDAL-3ETD4-U



Page 2 of 2

Certificates



EN ISO 9001:2015

We realize that the quality of our products substantially influences the overall performance of our customers' systems. Therefore we are committed to deliver high quality as defined by ISO 9001:2015. Our quality goals and their realization are documented in our quality management handbook and in process documents.

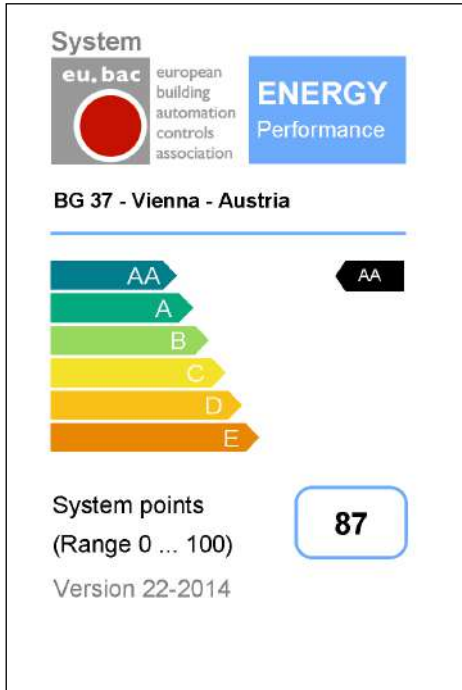

eu.bac System Certification

Thanks to the efficiency features of the room automation system L-ROC, LOYTEC was able to acquire an eu.bac system certification of the highest class AA, reaching 87 out of 100 possible points, for the new building at Blumengasse 37 in March 2014. The registered eu.bac Cert Mark symbolizes energy efficiency and quality and is also the European quality label for products in the field of building automation.

TRAINING

We offer trainings in multiple languages. Training dates are available at www.loytec.com/training. Please contact sales@loytec.com for additional training dates or trainings at a location of your choice.



LTRAIN-LSTUDIO

Programming the L-INX Automation Server (2 days)

- Introduction into the L-STUDIO Software
- Concepts and structure of the IEC 61131 and IEC 61499 language
- Creating function logic with data points and graphical systems
- Working with function blocks, device types and resources
- Testing and debugging of the system
- Configuration of schedulers, alarms, and trends
- Deploying of logic and graphical projects
- Contents of the LOYTEC building automation library
- Working with the LOYTEC building automation library

LTRAIN-GRAPHICS

Graphical design with L-VIS and L-WEB (2 days)

- Creating L-VIS and LWEB-803 projects with the L-VIS/L-WEB Configurator
- Creating a distributed visualization based on L-INX and LWEB-803
- Efficient project design using templates

LTRAIN-BMS

LWEB-900 Building Management System (2 days)

- Introduction to the LWEB-900 system
- LWEB-900 Project Setup
- Working with LWEB-900 Views
- LWEB-900 User Management

LTRAIN-DALI

Lighting control with L-DALI (2 days)

- Introduction to DALI
- Features of the LOYTEC DALI Controllers
- Configuring LOYTEC DALI Controllers
- Setting up a DALI network
- Troubleshooting the DALI installation

LTRAIN-LROC

Room Automation with L-ROC (2 days)

Training dates are available on request

- System design based on a sample project
- Creating the IEC 61499 application for the same project
- Creating virtual room operating units/ use with LWEB-802/803
- Creating floor plan visualizations
- Integration into LWEB-900
- Parameterization, testing, and debugging the application
- Concepts and features of important IEC 61499 function blocks



NEW!

ONLINE-TRAININGS

Use our extensive online training program!

You can also acquire your LOYTEC know-how online. Find out more: www.loytec.com/training

Brochures



LOYTEC Express Magazine for Building Automation

The new LOYTEC Express: Full of information and news about our company, our products and our partners. In addition you will find handy tips and a glimpse behind the scenes of LOYTEC.

For a free copy, please contact info@loytec.com!

For more info go to www.loytec.com/news/loytec-express

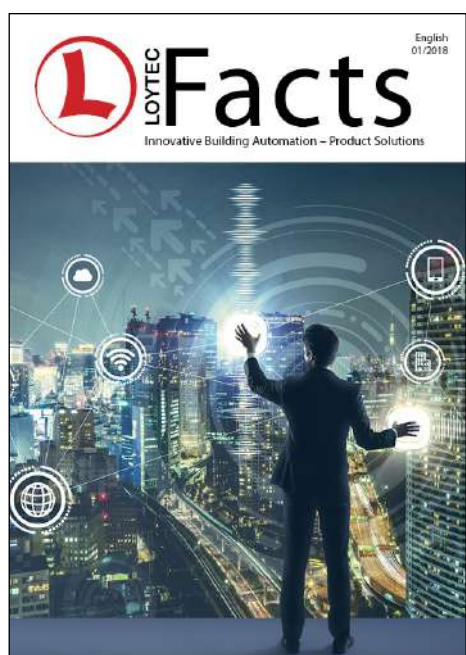

L-FACTS

The L-FACTS folders provide an overview of LOYTEC's product portfolio.

Our new digital-only L-FACTS Plus (26 pages) includes tables listing detailed product specifications.

If you wish to receive a free printed copy of our L-FACTS (8 pages), please send an e-mail request to info@loytec.com.

For more info go to www.loytec.com/products/catalogs.



L-FOCUS: L-DALI Lighting Control Solutions

L-FOCUS is an information brochure about LOYTEC automation solutions. The focus of this edition is on our intelligent L-DALI Lighting Control Solutions.

For a free copy, please contact info@loytec.com!

For more info go to www.loytec.com/products/catalogs.



L-VIS Touch Panel High-Gloss Brochure

The L-VIS Touch Panel high-gloss brochure provides information on our high-quality L-VIS touch panels and see how fascinating building control can be.

For a free copy, please contact info@loytec.com!

For more info go to www.loytec.com/products/catalogs.

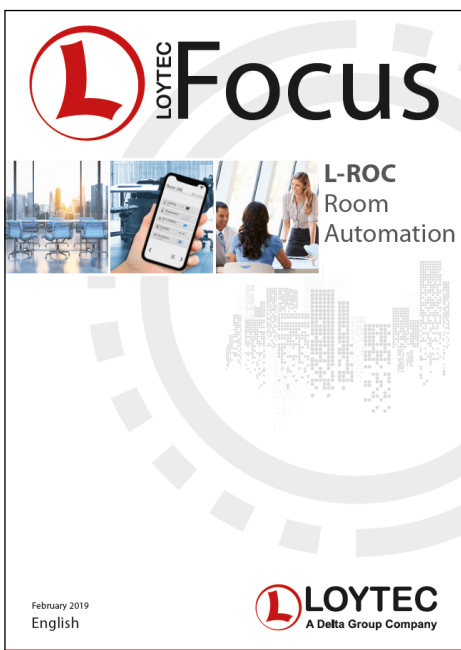

L-FOCUS: L-ROC Room Automation

L-FOCUS is an information brochure about LOYTEC automation solutions. The focus of this edition is on our L-ROC Room automation systems.

For more info go to www.loytec.com/products/catalogs.



LOYTEC Competence Partner

LOYTEC Competence Partner Program

LOYTEC is a provider of innovative product solutions for designing networked building automation systems and interconnected real estate. With our integrated products we offer the foundation to build highly efficient automation solutions.

We set high standards for ourselves regarding quality in research, development, and manufacturing of our products. As a LOYTEC Competence Partner you make a point of doing a professional planning and implementation of automation solutions to the satisfaction of your customers. With the Competence Partner Program we ensure that you get the necessary knowledge of LOYTEC products and implementation concepts through sustainable training programs.

A true partnership is the foundation for our joint success in the market.

Therefore LOYTEC offers:

- A balanced partnership while utilizing and marketing LOYTEC product solutions
- Adjusted training programs for products and implementation concepts
- Technical support for LOYTEC products and applications
- Access to the programmable L-INX Automation Servers and L-IOB I/O Controllers
- Access to L-WEB Building Management Software
- Access to LOYTEC graphics and function libraries
- Priority information on new products and solutions
- LOYTEC Competence Partner LOGO for use in your marketing activities
- Your company data on our website with link to your website

You offer:

- An established market access in building automation business
- Pro-active marketing of LOYTEC product solutions
- Pro-active feedback on LOYTEC products and market places
- A dedicated and technically well-trained team
- Regular attendance of LOYTEC trainings or trainings at a LOYTEC Competence Center
- At least two staff members in the team trained by LOYTEC or the LOYTEC Competence Center
- Preparation and publication of completed projects including a listing of utilized LOYTEC products and providing of project information for use by LOYTEC
- Link to LOYTEC website on your website

If you are interested in becoming LOYTEC Competence Partner, please contact sales@loytec.com





LOYTEC Competence Center

As part of our worldwide expansive distribution strategy LOYTEC Competence Centers are important partners in the local markets. Being cooperation and distribution partners, LOYTEC Competence Centers are authorized to distribute automation products such as L-INX Automation Servers, L-IOB I/O Controllers, and L-ROC Room Controllers to LOYTEC Competence Partners. Extended by infrastructure products, gateways, DALI lighting controllers and touch panels, LOYTEC Competence Centers provide the complete range of hardware and software products by LOYTEC.



LOYTEC Competence Partner

We set high standards for ourselves regarding quality in research, development and manufacturing of our products. As a 'Competence Partner' you make a point of doing a professional planning and completion of automation solutions to the satisfaction of your customers. With the 'Competence Partner Program' we ensure that you get the necessary knowledge for LOYTEC products and implementation concepts through sustainable training programs. A true partnership is the foundation for our joint success in the market.



LOYTEC Distributor

LOYTEC distributors offer standard products such as infrastructure products, gateways, DALI light controls and touch panels. If you are interested in LOYTEC automation products such as L-INX Automation Servers, L-IOB I/O Controllers, and L-ROC Room Controllers please contact us directly or contact a local LOYTEC Competence Center.

AST, LC3020, L-Chip, L-Core, L-DALI, L-ENO, L-GATE, L-INX, L-IOB, LIOB-AIR, LIOB-Connect, LIOB-FT, L-IOT, L-IP, L-KNX, L-MBUS, L-MPBUS, L-OPC, LPA, L-PAD, L-POW, L-Proxy, L-ROC, L-STAT, L-STUDIO, L-Switch^{XP}, L-TE, L-TEMP, L-Term, L-VIS, L-WEB, L-WLAN, L-SMI, LTRAIN, NIC, ORION Stack, Smart Auto-Connect, buildings under control are trademarks of LOYTEC electronics GmbH.

Echelon, LON, LONWORKS, LNS, LonMaker, and Neuron are trademarks of Echelon Corporation registered in the United States and other countries. LonMark and the LonMark Logo are registered trademarks owned by LonMark International. BACnet is a registered trade mark of the American Society of Heating, Refrigerating and Air Conditioning Engineers, Inc. (ASHRAE).

KNX Association cvba is the owner of the worldwide standard for Home and Building Control: KNX and also the owner of the KNX trademark logo worldwide. DiiA, DALI and DALI-2 logos are registered trademarks of the Digital Illumination Interface Alliance. EnOcean[®] and the EnOcean logo are registered trademarks of EnOcean GmbH.

Other trademarks and trade names used in this document refer either to the entities claiming the markets and names, or to their products. LOYTEC disclaims proprietary interest in the markets and names of others.

Statements in this report that relate to future results and events are based on the company's current expectations. Actual results in future periods may differ materially from those currently expected or desired because of a number of risks and uncertainties.

No part of this publication may be reproduced, stored in a retrieval system, or transmitted, in any form or by any means, electronic, mechanical, photocopying, recording, or otherwise, without the prior written permission of LOYTEC. Product specifications, availability, and design are subject to change without prior notice.

Document No. 04007425

2024-03-05

IMPRINT

Owner: LOYTEC electronics GmbH

Place of Publication: Vienna

Typesetting and printing errors reserved

© LOYTEC 2024

© Photos:

Metamorworks/Shutterstock, Zastolskiy Victor/Shutterstock, Jens Schöninger/PIXELIO, Michael Ottersbach/PIXELIO, escapechen/PIXELIO, Gemini Arts/PIXELIO, GiRom/PIXELIO, Rainer Sturm/PIXELIO

Marco Liotta, Oliver Heini

OUR MISSION

LOYTEC researches, develops and manufactures products and solutions to open up new ways and opportunities for the modern building automation business.

Utilizing innovative technologies and open communication protocols in trendsetting products, LOYTEC creates the basis for efficient system integration, highest energy efficiency during operation and protection of investment.



CONTACT

LOYTEC electronics GmbH
Blumengasse 35
1170 Vienna
Austria

www.loytec.com
sales@loytec.com
phone: +43 1 4020805 0
fax: +43 1 4020805 99

Delta Electronics (Americas), Inc.
LOYTEC
Building Automation Business Group
N27 W23957 Paul Road, Suite 103
Pewaukee, WI 53072, USA
www.loytec-americas.com
sales@loytec-americas.com
phone: +1 262 278 4370
fax: +1 262 408 5238

Delta Electronics, Inc.
256 Yangguang Street
Neihu District,
Taipei 114067
Taiwan
www.deltaww.com
bas.sales@deltaww.com
phone: +886 2 8797 2088
fax: +886 2 2659 8735

