

The image features a large, light blue rounded rectangle in the center. The word "KITZ" is written in a bold, white, sans-serif font across the middle of this rectangle. Below it, the words "GENERAL CATALOG" are written in a white, spaced-out, sans-serif font, extending across the width of the page. The background is a solid blue color with a dark blue triangle on the right side.

**KITZ**  
GENERAL CATALOG

**KITZ CORPORATION**

## The Reliable Brand

Since its establishment in 1951, KITZ Corporation has supplied products for applications ranging from the home to industrial processes as a manufacturer of valves and other devices for the control of fluids.

Over the years, we have grown into one of the world's leading valve manufacturers. Today, the KITZ brand has a solid reputation for outstanding quality in Japan and around the world.

As we enter a new century, concerns are growing about the global environment and access to sustainable sources of energy. At the same time, we are witnessing the advent of a society driven by sophisticated information and telecommunication technologies.

These developments will significantly alter our operating environment in the years ahead. KITZ Corporation is dedicated to increasing its corporate value through the provision of products and services rooted in originality and quality. We will focus on achieving even greater satisfaction for our customers, shareholders and the communities in which we operate.

KITZ Corporation will remain a manufacturer that concentrates on valves and other devices to control fluids, constantly working toward the goals of helping make our lives more fulfilling and earning the trust of all stakeholders.



A chrysanthemum-handle is a symbol of KITZ, the brand of valve reliability

## Product Lineup Targeting Requirements for Flow Control

Valves must be engineered to meet the demands of a broad spectrum of applications. Designs need to match the material, whether water, gas, oil or another substance, that is to be controlled. Temperature, pressure, control systems and other factors are also key considerations. With a diverse assortment of products, KITZ Corporation is able to meet every customer need involving valves.

## Technology

Starting out as a producer of manual valves, KITZ Corporation now employs advanced technology and quality control expertise to meet today's market needs with automated, centralized and other sophisticated fluid control techniques.

Even more innovative products are being created by sharing technology within the KITZ Group and through alliances with other companies.

This is what the KITZ brand stands for.

---

## Production

An exclusive production system, extending from order receipt through development, manufacture and delivery, eliminates waste, cuts costs and speeds deliveries.

Further backing up the reliability of KITZ products are exacting testing standards and a rigorous quality management program.

This is what the KITZ brand stands for.

---

## Major Production locations

### Japan

Plants in Japan handle everything from product development through manufacture, concentrating on value-added products. Priority is placed on new markets, new materials and new design functions. Japan also performs a vital role as the “control tower” for global manufacturing activities.

### Taiwan

Utilizing expertise in materials and processing technologies, our production plants in Taiwan produce mainly steel valves. These valves are sold in Japan and other countries around the world.

### Spain

This plant is a supply base for EU customers. Its main products are steel ball valves.

### Thailand

KITZ's plants in Thailand produce mainly copper alloy valves and butterfly valves. The plants combine sophisticated equipment with the just-in-time production method to achieve high productivity and adhere to the market-driven concept. These strengths make our plants in Thailand reliable suppliers of products to customers in many countries.

### China

This country, often referred to as the world's factory, is an extremely cost-efficient location for manufacturing valves. The KITZ Chinese plants manufacture steel valves for industrial applications.

---

## Global Marketing Network [www.kitz.com](http://www.kitz.com)



## Bronze & Brass

S	GATE	4
H	GATE	4
E	GATE	4
FH	GATE	4
FR	GATE	4
M	GATE	4
L	GATE	4
LB	GATE	4
125M	GATE	4
150S	GATE	4
150L	GATE	5
300LU	GATE	5
CH	GATE	5
CFS	GATE	5
CFH	GATE	5
CM	GATE	5
CL	GATE	5
C125E	GATE	5
C125M	GATE	5
C150E	GATE	5
C150L	GATE	6
C150LU	GATE	6
AKH	GATE	6
AKFS	GATE	6
AKFH	GATE	6
AK125E	GATE	6
AK125M	GATE	6
AK150E	GATE	6
AK150L	GATE	6
AK150LU	GATE	6
AK300LU	GATE	7
AS-FH	GATE	7
PN16S	GATE	7
PN16FH	GATE	7
PN20E	GATE	7
PN25H	GATE	7
A	GLOBE	7
Q	GLOBE	7
QA	GLOBE	7
G	GLOBE	7
C	GLOBE	8
CA	GLOBE	8
B	GLOBE	8
BH	GLOBE	8
D	GLOBE	8
DB	GLOBE	8
DBH	GLOBE	8
K	GLOBE	8
J	GLOBE	8
JB	GLOBE	8
150D	GLOBE	9
300D	GLOBE	9
C125C	GLOBE	9
C150D	GLOBE	9
AKA	GLOBE	9
AKG	GLOBE	9
AKC	GLOBE	9
AKCA	GLOBE	9
AK125C	GLOBE	9
AK150D	GLOBE	9
AK300D	GLOBE	10
AK300J	GLOBE	10
PN16A	GLOBE	10
PN16G	GLOBE	10
PN20D	GLOBE	10
PN25C	GLOBE	10
F	LIFT CHECK	10
R	SWING CHECK	10
O	SWING CHECK	10

OB	SWING CHECK	10
YR	SWING CHECK	11
10BWZ	WAFER CHECK	11
RF	LIFT CHECK	11
VF	LIFT CHECK	11
FT	FOOT CHECK	11
FTS	FOOT CHECK	11
150YR	SWING CHECK	11
300YR	SWING CHECK	11
CR	SWING CHECK	11
CYR	SWING CHECK	11
C150YR	SWING CHECK	12
CAF	LIFT CHECK	12
AKYR	SWING CHECK	12
AK150YR	SWING CHECK	12
AK300YR	SWING CHECK	12
AKAF	LIFT CHECK	12
PN16R	SWING CHECK	12
PN16YR	SWING CHECK	12
PN25F	LIFT CHECK	12
Y	Y TYPE STRAINER	12
CY	Y TYPE STRAINER	13
AKY	Y TYPE STRAINER	13
PN25Y	Y TYPE STRAINER	13

## Cast Iron

10FCHI	GATE	18
10FCL	GATE	18
10FCLS	GATE	18
125FCHI	GATE	18
125FCL	GATE	18
125FCLS	GATE	18
125FCWI	GATE	18
10FCJ	GLOBE	18
10FCJS	GLOBE	18
125FCJ	GLOBE	18
125FCJS	GLOBE	19
10FCO	SWING CHECK	19
10FCOC	SWING CHECK	19
125FCO	SWING CHECK	19
10FWZ	WAFER CHECK	19
125FWNB	WAFER CHECK	19
125FWNBE	WAFER CHECK	19
PN16FWNB	WAFER CHECK	19
PN16FWNBME	WAFER CHECK	19
10FCY	Y TYPE STRAINER	20
125FCY	Y TYPE STRAINER	20

## Ductile Iron

10SMS	GATE	24
10SMBF	GATE	24
10SMBOF	GATE	24
16SMB	GATE	24
16SMB0	GATE	24
16SMS	GATE	24
20SLS	GATE	24
150SMBO	GATE	24
10SJ	GLOBE	24
10SJBF	GLOBE	24
10SP	GLOBE	25
10SPBF	GLOBE	25
10SPBOF	GLOBE	25
10SPD	GLOBE	25
10SPDBF	GLOBE	25
10SPDBOF	GLOBE	25
10SD	GLOBE	25
10SDBF	GLOBE	25
10SDL	GLOBE	25
10SDLBF	GLOBE	25

16SP	GLOBE	26
16SPB	GLOBE	26
16SPBO	GLOBE	26
20SY	GLOBE	26
20SYB	GLOBE	26
150SPB	GLOBE	26
150SPDB	GLOBE	26
10SF	LIFT CHECK	26
10SFBF	LIFT CHECK	26
10SN	LIFT CHECK	26
10SNBF	LIFT CHECK	27
16SF	LIFT CHECK	27
16SFB	LIFT CHECK	27
20SN	LIFT CHECK	27
10SRBF	SWING CHECK	27
16SRB	SWING CHECK	27
20SOB	SWING CHECK	27
150SRB	SWING CHECK	27
10SWZU	WAFER CHECK	28
20SWZ	WAFER CHECK	28
20SWZU	WAFER CHECK	28
10FDY	Y TYPE STRAINER	28
10FDYBF	Y TYPE STRAINER	28
16FDY	Y TYPE STRAINER	28
16FDYB	Y TYPE STRAINER	28
20FDY	Y TYPE STRAINER	28

## Stainless Steel

UE	B-SEREAS GATE	32
UEM	B-SEREAS GATE	32
UEB	B-SEREAS GATE	32
UEBM	B-SEREAS GATE	32
UEL	B-SEREAS GATE	32
UELM	B-SEREAS GATE	32
DKUELM	B-SEREAS GATE	32
10UMA / 10UMAT	A-SEREAS GATE	32
10UMAM / 10UMAMT	A-SEREAS GATE	32
20UMA / 20UMAT	A-SEREAS GATE	32
20UMAM / 20UMAMT	A-SEREAS GATE	33
150UMA / 150UMAT	A-SEREAS GATE	33
150UMAM / 150UMAMT	A-SEREAS GATE	33
300UMA	A-SEREAS GATE	33
300UMAM	A-SEREAS GATE	33
600UMA	A-SEREAS GATE	33
600UMAM	A-SEREAS GATE	33
10UMAJ	A-SEREAS GATE	33
20UMAJ	A-SEREAS GATE	33
150UMAJ	A-SEREAS GATE	33
300UMAJ	A-SEREAS GATE	34
UAB	B-SEREAS GLOBE	34
UCL	B-SEREAS GLOBE	34
UCB	B-SEREAS GLOBE	34
UD	B-SEREAS GLOBE	34
UDM	B-SEREAS GLOBE	34
UDB	B-SEREAS GLOBE	34
UDBM	B-SEREAS GLOBE	34
UJ	B-SEREAS GLOBE	34
UJM	B-SEREAS GLOBE	34
UJB	B-SEREAS GLOBE	35
UJBM	B-SEREAS GLOBE	35
10UPA / G-10UPA / 10UPAT	A-SEREAS GLOBE	35
10UPAM / G-10UPAM / 10UPAMT	A-SEREAS GLOBE	35
20UPA / G-20UPA / 20UPAT	A-SEREAS GLOBE	35
20UPAM / G-20UPAM / 20UPAMT	A-SEREAS GLOBE	35
150UPA / G-150UPA / 150UPAT	A-SEREAS GLOBE	35
150UPAM / G-150UPAM / 150UPAMT	A-SEREAS GLOBE	35
300UPA / G-300UPA	A-SEREAS GLOBE	35
300UPAM / G-300UPAM	A-SEREAS GLOBE	35
600UPA	A-SEREAS GLOBE	36
600UPAM	A-SEREAS GLOBE	36

10UPAJ	A-SEREAS GLOBE	36
20UPAJ	A-SEREAS GLOBE	36
150UPAJ	A-SEREAS GLOBE	36
300UPAJ	A-SEREAS GLOBE	36
10UPAW	A-SEREAS GLOBE	36
10UPAWM	A-SEREAS GLOBE	36
20UPAW	A-SEREAS GLOBE	36
20UPAWM	A-SEREAS GLOBE	36
150UPAW	A-SEREAS GLOBE	37
150UPAWM	A-SEREAS GLOBE	37
300UPAW	A-SEREAS GLOBE	37
300UPAWM	A-SEREAS GLOBE	37
UN	B-SEREAS LIFT CHECK	37
UO	B-SEREAS SWING CHECK	37
UOM	B-SEREAS SWING CHECK	37
UOB	B-SEREAS SWING CHECK	37
UOBM	B-SEREAS SWING CHECK	37
10UNA / 10UNAT	A-SEREAS LIFT CHECK	37
10UNAM / 10UNAMT	A-SEREAS LIFT CHECK	38
20UNA / 20UNAT	A-SEREAS LIFT CHECK	38
20UNAM / 20UNAMT	A-SEREAS LIFT CHECK	38
150UNA / 150UNAT	A-SEREAS LIFT CHECK	38
150UNAM	A-SEREAS LIFT CHECK	38
300UNA	A-SEREAS LIFT CHECK	38
300UNAM	A-SEREAS LIFT CHECK	38
10UOA / 10UOAT	A-SEREAS SWING CHECK	38
10UOAM / 10UOAMT	A-SEREAS SWING CHECK	38
20UOA / 20UOAT	A-SEREAS SWING CHECK	38
20UOAM / 20UOAMT	A-SEREAS SWING CHECK	39
150UOA / 150UOAT	A-SEREAS SWING CHECK	39
150UOAM / 150UOAMT	A-SEREAS SWING CHECK	39
300UOA	A-SEREAS SWING CHECK	39
300UOAM	A-SEREAS SWING CHECK	39
600UOA	A-SEREAS SWING CHECK	39
600UOAM	A-SEREAS SWING CHECK	39
10UW	WAFER CHECK	39
10UWS	WAFER CHECK	39
10UNAJ	A-SEREAS LIFT CHECK	40
10UNAJM	A-SEREAS LIFT CHECK	40
20UNAJ	A-SEREAS LIFT CHECK	40
150UNAJ	A-SEREAS LIFT CHECK	40
300UNAJ	A-SEREAS LIFT CHECK	40
10UOAJ	A-SEREAS SWING CHECK	40
20UOAJ	A-SEREAS SWING CHECK	40
150UOAJ	A-SEREAS SWING CHECK	40
300UOAJ	A-SEREAS SWING CHECK	40
10UFT	BALL CHECK	41
10UFTE	BALL CHECK	41
UY	B-SEREAS Y TYPE STRAINER	41
UYM	B-SEREAS Y TYPE STRAINER	41
UYB	B-SEREAS Y TYPE STRAINER	41
UYBM	B-SEREAS Y TYPE STRAINER	41
10UYA	A-SEREAS Y TYPE STRAINER	41
10UYAM	A-SEREAS Y TYPE STRAINER	41
20UYA	A-SEREAS Y TYPE STRAINER	41
UN3-AP-	NEEDLE mm. Series	42
UN3-BP-	NEEDLE mm. Series	42
UN3-CP-	NEEDLE mm. Series	42
UN3-DP-	NEEDLE mm. Series	42
UN3-EP-	NEEDLE mm. Series	42
UN3-FP-	NEEDLE mm. Series	42
UN26-AP-	NEEDLE mm. Series	42
UN26-CP-	NEEDLE mm. Series	42
UN26-SP-	NEEDLE mm. Series	42
UN3-CP-	NEEDLE inch Series	42
UN3-DP-	NEEDLE inch Series	42
UN3-EP-	NEEDLE inch Series	42
UN3-FP-	NEEDLE inch Series	42
UN26-CP-	NEEDLE inch Series	42

## Carbon Steel

10SCLS	GATE	46
20SCLS	GATE	46
150SCLS	GATE	46
300SCLS	GATE	46
10SCJS	GLOBE	46
20SCJS / G-20SCJS	GLOBE	46
150SCJS / G-150SCJS	GLOBE	46
300SCJS / G-300SCJS	GLOBE	46
10SCOS	SWING CHECK	46
20SCOS	SWING CHECK	46
150SCOS	SWING CHECK	47
300SCOS	SWING CHECK	47

## Butterfly Valve

10XJME	BUTTERFLY	56
G-10XJME	BUTTERFLY	56
(PH)PN16XJME	BUTTERFLY	56
(PH)G-PN16XJME	BUTTERFLY	56
10DJ	BUTTERFLY	56
G-10DJ	BUTTERFLY	56
VG-10DJ	BUTTERFLY	56
PN16DJ	BUTTERFLY	56
G-PN16DJ	BUTTERFLY	56
PN16DJL	BUTTERFLY	56
G-PN16DJL	BUTTERFLY	57
PN25DJE	BUTTERFLY	57
PN25DJLE	BUTTERFLY	57
G-150DJ	BUTTERFLY	57
G-150DJE	BUTTERFLY	57
G-150DJL	BUTTERFLY	57
200DJ	BUTTERFLY	57
200DJL	BUTTERFLY	57
G-200DJ	BUTTERFLY	57
G-200DJE	BUTTERFLY	57
250DJL	BUTTERFLY	58
G-200DJL	BUTTERFLY	58
G-200DJLE	BUTTERFLY	58
250DJ	BUTTERFLY	58
G-250DJ	BUTTERFLY	58
G-250DJE	BUTTERFLY	58
250DJL	BUTTERFLY	58
G-250DJL	BUTTERFLY	58
G-250DJLE	BUTTERFLY	58
G-250DJA	BUTTERFLY	58
G-250DJA	BUTTERFLY	58
G-250DJAE	BUTTERFLY	58
G-250DJLA	BUTTERFLY	59
G-250DJLAE	BUTTERFLY	59
10UB	BUTTERFLY	59
GL-10UB	BUTTERFLY	59
GL-150UB	BUTTERFLY	59
10NFJNE	BUTTERFLY	59
10NFJNE	BUTTERFLY	59
10NFJNW	BUTTERFLY	59
G-10NFJNW	BUTTERFLY	59
10D	DAMPER	59
GL-10D	DAMPER	60
GL-10A	DAMPER	60
UV	BUTTERFLY	60
FV	BUTTERFLY	60

## Ball Valve

T	FLOATING BALL	72
AKT	FLOATING BALL	72
TT	FLOATING BALL	72
TO	FLOATING BALL	72
TF	FLOATING BALL	72
TG	FLOATING BALL	72
TB	FLOATING BALL	72

TL	FLOATING BALL	72
CTL	FLOATING BALL	72
TLT	FLOATING BALL	72
TFJ	FLOATING BALL	73
TH	FLOATING BALL	73
TM	FLOATING BALL	73
TK	FLOATING BALL	73
AKTK	FLOATING BALL	73
TKT	FLOATING BALL	73
TKW	FLOATING BALL	73
TN	3WAY FLOATING BALL	73
AKTN	3WAY FLOATING BALL	73
T4T	3WAY FLOATING BALL	73
T4L	3WAY FLOATING BALL	74
AK3TM	3 PIECE FLOATING BALL	74
AKTAF	FLOATING BALL	74
AKTAFM	FLOATING BALL	74
SZA	FLOATING BALL	74
AKSZA	FLOATING BALL	74
PN40SZA	FLOATING BALL	74
AKSZAW	FLOATING BALL	74
AKTAFLL	FLOATING BALL	74
10FCT	FLOATING BALL	74
10FCTB	FLOATING BALL	75
10FCTR	FLOATING BALL	75
125FCTB	FLOATING BALL	75
125FCTR	FLOATING BALL	75
10FCTB2L	3WAY FLOATING BALL	75
10FCTR2L	3WAY FLOATING BALL	75
STZ	FLOATING BALL	75
20ST	FLOATING BALL	75
10STBF	FLOATING BALL	75
10STB4TAF	3WAY FLOATING BALL	75
10STB4LAF	3WAY FLOATING BALL	76
10STR4TAF	3WAY FLOATING BALL	76
10STR4LAF	3WAY FLOATING BALL	76
10STLBF	FLOATING BALL	76
20STLB	FLOATING BALL	76
UTK	FLOATING BALL	76
UTKM	FLOATING BALL	76
UTKW	FLOATING BALL	76
UTKMW	FLOATING BALL	76
UTFM	FLOATING BALL	76
UTH	FLOATING BALL	77
UTHM	FLOATING BALL	77
UTHL	FLOATING BALL	77
UTH4LM	3WAY FLOATING BALL	77
UTH4TM	3WAY FLOATING BALL	77
U3TZM	3 PIECE FLOATING BALL	77
SWU3TZM	3 PIECE FLOATING BALL	77
10UT	FLOATING BALL	77
10UTB / G-10UTB	FLOATING BALL	77
10UTDZ	FLOATING BALL	77
10UTDZM	FLOATING BALL	78
20UTDZ	FLOATING BALL	78
20UTDZM	FLOATING BALL	78
10UTR	FLOATING BALL	78
20UTR	FLOATING BALL	78
150UTB / G-150UTB	FLOATING BALL	78
150UTBM	FLOATING BALL	78
150UTDZ / G-150UTDZ	FLOATING BALL	78
150UTDZM / G-150UTDZM	FLOATING BALL	78
300UTDZ	FLOATING BALL	78
300UTDZM	FLOATING BALL	79
150UTR	FLOATING BALL	79
300UTR	FLOATING BALL	79
10UTB2T	3WAY FLOATING BALL	79
10UTB2TM	3WAY FLOATING BALL	79
10UTB2L	3WAY FLOATING BALL	79
10UTR2L	3WAY FLOATING BALL	79
10UTB2LM	3WAY FLOATING BALL	79

10UTB4LA	3WAY FLOATING BALL	79
10UTB4LAM	3WAY FLOATING BALL	79
10UTB4TA	3WAY FLOATING BALL	80
10UTB4TAM	3WAY FLOATING BALL	80
10UTBLN	FLOATING BALL	80
10UTBT	FLOATING BALL	80
10UTBJ	FLOATING BALL	80
10UTBJM	FLOATING BALL	80
150UTBJ	FLOATING BALL	80
300UTBJ	FLOATING BALL	80
L-10UVVC	LAMBDA PORT	80
L-150UVVC / G-150UVVC	LAMBDA PORT	80
10UTDZ1H	FLOATING BALL	81
10UTDZ1HM	FLOATING BALL	81
20UTDZ1H / G-20UTDZ1H	FLOATING BALL	81
10UTDZ3H / G-10UTDZ3H	FLOATING BALL	81
20UTDZ3H / G-20UTDZ3H	FLOATING BALL	81
10UTDZ5H / G-10UTDZ5H	FLOATING BALL	81
20UTDZ5H / G-20UTDZ5H	FLOATING BALL	81
10UTDZ6H / G-10UTDZ6H	FLOATING BALL	81
10UTDZ6HM	FLOATING BALL	81
20UTDZ6H / G-20UTDZ6H	FLOATING BALL	81
150UTDZ / G-150UTDZ	FLOATING BALL	82
150UTDZ1H / G-150UTDZ1H	FLOATING BALL	82
150UTDZ1HM / G-150UTDZ1HM	FLOATING BALL	82
300UTDZ1H	FLOATING BALL	82
300UTDZ1HM	FLOATING BALL	82
150UTDZ3H / G-150UTDZ3H	FLOATING BALL	82
150UTDZ3HM / G-150UTDZ3HM	FLOATING BALL	82
300UTDZ3H / G-300UTDZ3H	FLOATING BALL	82
300UTDZ3HM / G-300UTDZ3HM	FLOATING BALL	82
150UTDZ5H / G-150UTDZ5H	FLOATING BALL	82
150UTDZ5HM / G-150UTDZ5HM	FLOATING BALL	83
300UTDZ5H / G-300UTDZ5H	FLOATING BALL	83
300UTDZ5HM / G-300UTDZ5HM	FLOATING BALL	83
150UTDZ6H / G-150UTDZ6H	FLOATING BALL	83
150UTDZ6HM / G-150UTDZ6HM	FLOATING BALL	83
300UTDZ6H / G-300UTDZ6H	FLOATING BALL	83
300UTDZ6HM / G-300UTDZ6HM	FLOATING BALL	83
150UTDZXL / G-150UTDZXL	FLOATING BALL	83
300UTDZXL / G-300UTDZXL	FLOATING BALL	83
SCTK	FLOATING BALL	84
10SCTDZ	FLOATING BALL	84
20SCTDZ	FLOATING BALL	84
150SCTDZ / G-150SCTDZ	FLOATING BALL	84
150SCTDZM	FLOATING BALL	84
300SCTDZ	FLOATING BALL	84
300SCTDZM	FLOATING BALL	84
10SCTDZ1H	FLOATING BALL	84
20SCTDZ1H / G-20SCTDZ1H	FLOATING BALL	84
150SCTDZ1H / G-150SCTDZ1H	FLOATING BALL	84
300SCTDZ1H / G-300SCTDZ1H	FLOATING BALL	85
10SCTDZ3H / G-10SCTDZ3H	FLOATING BALL	85
20SCTDZ3H / G-20SCTDZ3H	FLOATING BALL	85
150SCTDZ3H / G-150SCTDZ3H	FLOATING BALL	85
300SCTDZ3H / G-300SCTDZ3H	FLOATING BALL	85
10SCTDZ5H / G-10SCTDZ5H	FLOATING BALL	85
20SCTDZ5H / G-20SCTDZ5H	FLOATING BALL	85
150SCTDZ5H / G-150SCTDZ5H	FLOATING BALL	85
300SCTDZ5H / G-300SCTDZ5H	FLOATING BALL	85
10SCTDZ6H / G-10SCTDZ6H	FLOATING BALL	85
20SCTDZ6H / G-20SCTDZ6H	FLOATING BALL	86
150SCTDZ6H / G-150SCTDZ6H	FLOATING BALL	86
300SCTDZ6H / G-300SCTDZ6H	FLOATING BALL	86

## Ball Valve Seat

88

## Actuated Valves

EA100/200-TE	FLOATING BALL	104
EA100/200-TFE	FLOATING BALL	104
EA100/200-TGE	FLOATING BALL	104
EA100/200-TNE	3WAY FLOATING BALL/3WAY TRUNNION BALL	104
EA100/200-UTE	FLOATING BALL	104
EA100/200-UTFE	FLOATING BALL	104
EA100/200-UTGE	FLOATING BALL	104
EA100/200-UTNE	3WAY FLOATING BALL	104
ED12/24-TE	FLOATING BALL/TRUNNION BALL	104
ED12/24-TNE	3WAY FLOATING BALL/3WAY TRUNNION BALL	104
ED12/24-UTE	FLOATING BALL	105
ED12/24-UTFE	FLOATING BALL/TRUNNION BALL	105
ED12/24-UTGE	FLOATING BALL	105
EXS100/200-10DJ	BUTTERFLY	106
EXS100/200-10DJE	BUTTERFLY	106
EXS100/200-10XJME	BUTTERFLY	106
C-TE	FLOATING BALL/TRUNNION BALL	107
C-TFE	FLOATING BALL/TRUNNION BALL	107
C-TGE	FLOATING BALL	107
C-TLE	FLOATING BALL/TRUNNION BALL	107
C-TNE	3WAY FLOATING BALL/3WAY TRUNNION BALL	107
C-TUE	FLOATING BALL	107
C-UTE	FLOATING BALL	107
C-UTGE	FLOATING BALL	107
C-UTNE	3WAY FLOATING BALL	107
CS-TE	FLOATING BALL	107
CS-TLE	FLOATING BALL	108
CS-TNE	3WAY FLOATING BALL	108
CS-TUE	FLOATING BALL	108
CS-UTE	FLOATING BALL	108
CS-UTGE	FLOATING BALL	108
CS-UTNE	3WAY FLOATING BALL	108
FA-10FCT	FLOATING BALL	108
FA-10FCTB	FLOATING BALL	108
FA-10FCTB2L	3WAY FLOATING BALL	108
FA-10SCTDZ	FLOATING BALL	108
FA-10UT	FLOATING BALL	109
FA-10UTB2L	3WAY FLOATING BALL	109
FA-10UTB4LAM	3WAY FLOATING BALL	109
FA-10UTBLN	FLOATING BALL	109
FA-10UTDZ	FLOATING BALL	109
FA-150SCTDZ	FLOATING BALL	109
FA-150UTDZ	FLOATING BALL	109
FA-20SCTDZ	FLOATING BALL	109
FA-20UTDZ	FLOATING BALL	109
FA-300SCTDZ	FLOATING BALL	109
FA-300UTDZ	FLOATING BALL	110
FA-300UTDZM	FLOATING BALL	110
FA-10XJME	BUTTERFLY	110
FA-10DJ	BUTTERFLY	110
FA-10DJE	BUTTERFLY	110
FAS-10FCT	FLOATING BALL	110
FAS-10FCTB	FLOATING BALL	110
FAS-10FCTB2L	3WAY FLOATING BALL	110
FAS-10SCTDZ	FLOATING BALL	110
FAS-10UT	FLOATING BALL	110
FAS-10UTB2L	3WAY FLOATING BALL	111
FAS-10UTB4LA	3WAY FLOATING BALL	111
FAS-10UTBLN	FLOATING BALL	111
FAS-10UTDZ	FLOATING BALL	111
FAS-150SCTDZ	FLOATING BALL	111
FAS-150UTDZ	FLOATING BALL	111
FAS-150UTDZM	FLOATING BALL	111
FAS-20SCTDZ	FLOATING BALL	111
FAS-20UTDZ	FLOATING BALL	111
FAS-300SCTDZ	FLOATING BALL	111
FAS-300UTDZ	FLOATING BALL	112
FAS-300UTDZM	FLOATING BALL	112
FAS-10XJME	BUTTERFLY	112

FAS-10DJ	BUTTERFLY	112
FAS-10DJE	BUTTERFLY	112
B-10FCT	FLOATING BALL	112
B-10FCTB	FLOATING BALL	112
B-10FCTB2L	3WAY FLOATING BALL	112
B-10STLBF	FLOATING BALL	112
B-10UT	FLOATING BALL	112
B-10UTDZ	FLOATING BALL	113
B-10UTDZM	FLOATING BALL	113
B-10SCTDZ	FLOATING BALL	113
B-10UTB2L	3WAY FLOATING BALL	113
B-10UTB4LA	3WAY FLOATING BALL	113
B-10UTBLN	FLOATING BALL	113
B-150SCTDZ	FLOATING BALL	113
B-150UTDZ	FLOATING BALL	113
B-150UTDZM	FLOATING BALL	113
B-20SCTDZ	FLOATING BALL	113
B-20UTDZ	FLOATING BALL	114
B-20UTDZM	FLOATING BALL	114
B-300SCTDZ	FLOATING BALL	114
B-300UTDZ	FLOATING BALL	114
B-300UTDZM	FLOATING BALL	114
B-10DJ	BUTTERFLY	114
B-10DJE	BUTTERFLY	114
BS-10FCT	FLOATING BALL	114
BS-10FCTB	FLOATING BALL	114
BS-10FCTB2L	3WAY FLOATING BALL	114
BS-10STLBF	FLOATING BALL	115
BS-10UT	FLOATING BALL	115
BS-10UTDZ	FLOATING BALL	115
BS-10UTDZM	FLOATING BALL	115
BS-10SCTDZ	FLOATING BALL	115
BS-10UTB2L	3WAY FLOATING BALL	115
BS-10UTB4LA	3WAY FLOATING BALL	115
BS-10UTBLN	FLOATING BALL	115
BS-10UVVC	LAMBDA PORT	115
BS-150SCTDZ	FLOATING BALL	115
BS-150UTDZ	FLOATING BALL	116
BS-20SCTDZ	FLOATING BALL	116
BS-20UTDZ	FLOATING BALL	116
BS-20UTDZM	FLOATING BALL	116
BS-300SCTDZ	FLOATING BALL	116
BS-300UTDZ	FLOATING BALL	116
BS-300UTDZM	FLOATING BALL	116
BS-10DJ	BUTTERFLY	116
BS-10DJE	BUTTERFLY	116

# BRONZE & BRASS

# Presenting Design Features of KITZ Bronze/Brass Valves

## Human Engineering in Handwheel Design

Computer designed handwheels of all KITZ bronze/brass valves, the product of KITZ human engineering, are featured with an ideal combination of an operational efficiency and high mechanical strength for reliability.

## Asbestos-free Gland Packings

All KITZ bronze/brass gate and globe valves employ Aramid Fiber PTFE as the material of asbestos-free gland packing, meeting the latest industrial demand to minimize pollutional concerns. With its leak-free sealing performance and reduced valve operating torque, Aramid Fiber PTFE is considered a reliable substitution for conventional asbestos sheet for service of water, oil, gas and saturated steam pressure of maximum 300psi within the temperature range up to 300°C.

## Pressure Rating

The pressure rating designation of KITZ valves follows the accepted practice of the valve and pipe fitting industry today. Each product is rated for W.O.G. (Non-shock cold water, oil, and gas\*) and Saturated steam pressure service.

\*Please refer to our website ([www.kitz.co.jp](http://www.kitz.co.jp)) or contact KITZ for details.

## Inspection and Testing

KITZ valves are manufactured under strict quality control throughout all stages of production, beginning with inspection of chemical composition and mechanical properties of materials. Extra care is given to inspection and testing at all machine shops and assembly plants, utilizing up-to-date precision equipment. All KITZ valves are subjected to strict pressure testing of body and seat sealing to assure long-life service and quality performance.

\*The valves introduced in this catalog are not designed to handle toxic gases. Use specially designed or certified valves for flammable gas service.

## PN Series Valves Pressure-Temperature Ratings

Maximum permissible working pressure (bar)

Service temperature (°C)	Bronze & Brass valves		
	PN16	PN20	PN25
	-10 to 66		
100	16.0	20.0	25.0
120	13.5	17.2	21.8
150	9.5	13.0	16.5
170	7.0	10.3	12.8
180	-	9.0	11.3
186	-	-	10.5
198	-	-	-
200	-	-	-

(Note) : Intermediate values may be obtained by linear interpolation.

## Bronze/Brass Valve Solder Joints

Copper tubing is widely used with bronze/brass valves in steam and water-line applications in schools, hospitals, hotels, and private houses because of excellent physical characteristics. It resists corrosion, meets sanitation requirements, and is easy to install.

**Copper Tubes:** There are three types of copper tubing for complying with ASTM B88 shown below.

Each type is provided with a different wall thickness to meet application requirements.

<b>Type K</b>	For use in steam, oil and gas lines for underground installation and/or severe conditions.
<b>Type L</b>	For general cooling and heating systems and related water piping and ventilation systems.
<b>Type M</b>	For home air-conditioning and heating applications.

 <b>CAUTION</b>	Solder joint end valves should not be used in service where the temperature of the line fluid is higher than the softening point of solder.
--	---

## Soldering Leak-free Joints

Use solder of 95-5 tin-antimony or 96-4 tin-silver, and an open-flame torch. Keep torch temperature relatively low to assure a firmly soldered joint. Because the solder melting point ranges 500°F (260°C) solder jointed valves cannot be used for high temperature service.

## Solder P-T Rating

Solder	Max. temp. (°C)	Max. working pressure					
		size 1/4"~1"		size 1/4"~2"		size 2 1/4"~4"	
		MPa	psi	MPa	psi	MPa	psi
95-5 tin-antimony [H95 Sb-5A]	38	3.45	500	2.76	400	2.07	300
	66	2.76	400	2.41	350	1.90	275
96-4 tin-silver [H96 Ag-3.5A]	93	2.07	300	1.72	250	1.38	200
	121	1.38	200	1.21	175	1.03	150

Bronze & Brass, Cast Iron, Ductile Iron, Stainless Steel, Carbon Steel, Butterfly Valve, Ball Valve, Actuated Valve



## KITZ Bronze and Brass Materials to JIS Standards

### JIS H5120-2006 (Copper & Copper Alloy Castings)

Cast bronze Class 6	Designation	Chemical composition (%)										Mechanical property	
		Cu	Sn	Zn	Pb	Ni	Fe	P	Sb	Al	Si	Tensile strength 195 Min. (N/mm <sup>2</sup> )	Elongation (%) 15 Min.
	CAC406 (BC6)	83.0-87.0	4.0-6.0	4.0-6.0	4.0-6.0	1.0 Max.	0.3 Max.	0.05 Max.	0.2 Max.	0.01 Max.	0.01 Max.		

### JIS H3250-2006 (Copper & Copper Alloy Rods and Bars)

Forged brass Alloy No.3771	Designation		Chemical composition (%)				Mechanical property	
	Extruded	Drawn	Cu	Pb	Fe + Sn	Zn	Tensile strength 315 Min. (N/mm <sup>2</sup> )	Elongation (%) 15 Min.
	C3771BE	C3771BD	57.0-61.0	1.0-2.5	1.0 Max.	Remainder		

### JIS H3250-2006 (Copper & Copper Alloy Rods and Bars)

Free-cutting brass Alloy No.3604	Designation		Chemical composition (%)					Mechanical property	
	Extruded	Drawn	Cu	Pb	Fe	Fe + Sn	Zn	Tensile strength 335 Min. (N/mm <sup>2</sup> )	Elongation (%) -
	C3604BE	C3604BD	57.0-61.0	1.8-3.7	0.5 Max.	1.0 Max.	Remainder		

## KITZ Bronze and Brass Materials to ASTM Standards

### ASTM B62-2002

Chemical composition (%)											Mechanical properties		
Copper	Tin	Lead	Zinc	Nickel & cobalt	Iron	Sulfur	Phosphorus	Antimony	Aluminum	Silicon	Minimum		
84.0-86.0	4.0-6.0	4.0-6.0	4.0-6.0	1.0 Max.	0.30 Max.	0.08 Max.	0.05 Max.	0.25 Max.	0.005 Max.	0.005 Max.	Tensile strength 30 ksi	Yield strength 14 ksi	Elongation in 2 in. 20%

### ASTM B584 C84400-2004

Chemical composition (%)											Mechanical properties		
Copper	Tin	Lead	Zinc	Nickel & cobalt	Iron	Sulfur	Phosphorus	Antimony	Aluminum	Silicon	Minimum		
78.0-82.0	2.3-3.5	6.0-8.0	7.0-10.0	1.0 Max.	0.40 Max.	0.08 Max.	0.02 Max.	0.25 Max.	0.005 Max.	0.005 Max.	Tensile strength 29 ksi	Yield strength 13 ksi	Elongation in 2 in. 18%

### ASTM B283 C37700-2004

Chemical composition (%)				Mechanical properties		
Copper	Lead	Iron	Zinc	Minimum		
58.0-61.0	1.5-2.5	0.30 Max.	Remainder	Tensile strength 50 ksi	Yield strength 18 ksi	Elongation in 4x thickness 25%

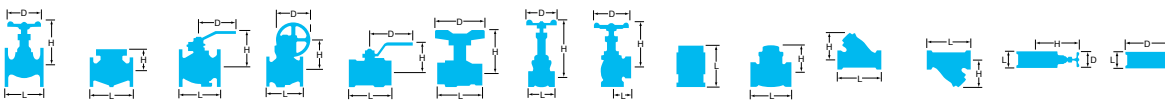

TYPE		GATE			GATE			GATE			GATE			GATE			
Bronze&Brass																	
FIG		S			H			E			FH			FR			
PRESSURE		Class 125			Class 125			Class 150			Class 125			Class 125			
END CONNECTION		BS21 (JIS B0203)			BS21 (JIS B0203)			BS21 (JIS B0203)			BS21			BS21 (JIS B0203)			
DIMENSIONS	inch	mm	L	H	D	L	H	D	L	H	D	L	H	D	L	H	D
	1/4	8	—	—	—	—	—	—	—	—	—	35	70	50	—	—	—
	3/8	10	38	75	50	42	74	50	43	86	50	38	73	50	38	73	50
	1/2	15	42	75	50	45	80	50	48	96	55	42	73	50	42	73	50
	3/4	20	47	86	55	50	90	55	53	111	60	47	87	55	47	87	55
	1	25	50	97	60	57	105	60	62	122	70	50	97	60	50	97	60
	1 1/4	32	60	117	70	61	118	70	69	141	80	60	118	70	60	118	70
	1 1/2	40	63	126	80	67	135	80	75	164	90	63	126	80	63	126	80
	2	50	72	154	90	74	159	90	86	197	100	72	154	90	72	154	90
	2 1/2	65	80	167	100	90	202	115	105	225	115	82	187	100	—	—	—
	3	80	90	200	115	100	223	135	116	261	135	92	205	115	—	—	—
	4	100	—	—	—	121	280	155	—	—	—	—	—	—	—	—	—
BODY		Cast Bronze			Cast Bronze			Cast Bronze			Forged Brass			Forged Brass			
BONNET		Forged Brass			Cast Bronze			Forged Brass			Forged Brass			Forged Brass			
STEM		Special Brass			Special Brass			Special Brass			Special Brass			Special Brass			
DISC		Forged Brass			Cast Bronze			Cast Bronze			Forged Brass			Forged Brass			
			Non-rising Stem			Non-rising Stem			Non-rising Stem			Non-rising Stem			Non-rising Stem		

TYPE		GATE			GATE			GATE			GATE			GATE			
Bronze&Brass																	
FIG		M			L			LB			125M			150S			
PRESSURE		5K			10K			10K			Class 125			Class 150			
END CONNECTION		BS21 (JIS B0203)			BS21 (JIS B0203)			JIS B2011			BS21 (JIS B0203)			BS21 (JIS B0203)			
DIMENSIONS	inch	mm	L	H	D	L	H	D	L	H	D	L	H	D	L	H	D
	1/4	8	—	—	—	—	—	—	—	—	—	—	—	—	—	—	—
	3/8	10	—	—	—	—	—	—	—	—	—	—	—	—	—	—	—
	1/2	15	50	126	60	55	126	60	—	—	—	51	129	55	42	75	50
	3/4	20	60	145	60	65	153	70	90	153	70	56	155	60	47	86	55
	1	25	65	170	70	70	178	80	100	178	80	66	180	70	50	97	60
	1 1/4	32	75	213	90	80	223	90	110	223	90	68	216	80	60	117	70
	1 1/2	40	85	244	100	90	254	100	125	254	100	74	257	90	63	126	80
	2	50	95	294	115	100	302	115	140	302	115	84	296	100	72	154	90
	2 1/2	65	115	366	135	120	376	155	170	376	155	—	—	—	80	167	100
	3	80	130	428	155	140	436	180	190	282	180	—	—	—	90	200	115
	4	100	—	—	—	—	—	—	220	327	225	—	—	—	—	—	—
BODY		Bronze			Bronze			Bronze			Cast Bronze			Cast Bronze			
BONNET		Cast Bronze			Cast Bronze			Cast Bronze			Cast Bronze			Cast Bronze			
STEM		Special Brass			Special Brass			Special Brass			Cast Bronze			Cast Bronze			
DISC		Bronze			Cast Bronze			Cast Bronze			Cast Bronze			Copper-Nickel Alloy			
												Non-rising Stem					

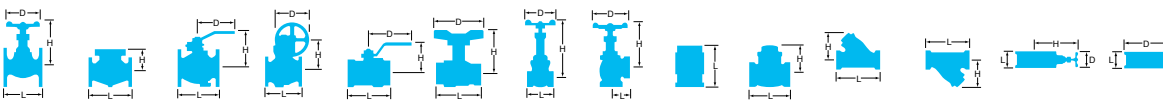

TYPE		GATE					GATE			GATE			GATE			GATE		
Bronze&Brass																		
FIG		150L					300LU			CH			CFS			CFH		
PRESSURE		Class 150					Class 300			Class 125			Class 125			Class 125		
END CONNECTION		BS21 (JIS B0203)					BS21 (JIS B0203)			ASME B16.18			Solder Joint			ASME B16.18		
DIMENSIONS	inch	mm	L	H	D	L	H	D	L	H	D	L	H	D	L	H	D	
	1/4	8	-	-	-	-	-	-	-	-	-	-	-	-	-	-	-	
	3/8	10	-	-	-	-	-	-	39	74	50	-	-	-	37	77	50	
	1/2	15	51	137	55	51	149	70	46	80	50	45	75	50	45	77	50	
	3/4	20	56	157	70	56	173	80	61	90	55	60	86	55	60	87	55	
	1	25	66	180	70	66	194	80	72	105	60	70	97	60	70	97	60	
	1 1/4	32	68	216	80	74	228	100	78	118	70	77	117	70	77	118	70	
	1 1/2	40	74	257	90	84	274	115	87	135	80	86	126	80	86	126	80	
	2	50	84	296	100	98	313	135	102	159	90	102	154	90	104	154	90	
	2 1/2	65	-	-	-	-	-	-	115	202	115	-	-	-	115	187	100	
	3	80	-	-	-	-	-	-	130	223	135	-	-	-	127	205	115	
	4	100	-	-	-	-	-	-	173	280	155	-	-	-	-	-	-	
BODY		Cast Bronze					Cast Bronze			Cast Bronze			Forged Brass			Forged Brass		
BONNET		Cast Bronze					Cast Bronze			Cast Bronze			Forged Brass			Forged Brass		
STEM		Cast Bronze					Cast Bronze			Special Brass			Special Brass			Special Brass		
DISC		Cast Bronze					Copper-Nickel Alloy			Cast Bronze			Forged Brass			Forged Brass		
										Solder end joint Non-rising Stem			Solder end joint Non-rising Stem			Solder end joint Non-rising Stem		

TYPE		GATE					GATE			GATE			GATE			GATE		
Bronze&Brass																		
FIG		CM					CL			C125E			C125M			C150E		
PRESSURE		5K					10K			Class 125			Class 125			Class 150		
END CONNECTION		JIS B2011					JIS B2011			ASME B16.18			ASME B16.18			ASME B16.18		
DIMENSIONS	inch	mm	L	H	D	L	H	D	L	H	D	L	H	D	L	H	D	
	1/4	8	-	-	-	-	-	-	-	-	-	-	-	-	-	-	-	
	3/8	10	-	-	-	-	-	-	39	86	50	-	-	-	-	-	-	
	1/2	15	50	126	60	50	126	60	46	93	55	49	129	55	46	98	55	
	3/4	20	65	145	60	65	153	70	60	110	70	64	155	60	60	114	70	
	1	25	75	170	70	75	178	80	71	126	70	76	180	70	71	126	70	
	1 1/4	32	80	213	90	82	223	90	79	145	80	82	216	80	79	145	80	
	1 1/2	40	88	244	100	92	254	100	88	176	90	86	257	90	88	176	90	
	2	50	108	294	115	110	302	115	108	201	100	109	296	100	108	201	100	
	2 1/2	65	-	-	-	-	-	-	-	-	-	-	-	-	-	-	-	
	3	80	-	-	-	-	-	-	-	-	-	-	-	-	-	-	-	
	4	100	-	-	-	-	-	-	-	-	-	-	-	-	-	-	-	
BODY		Cast Bronze					Cast Bronze			Cast Bronze			Cast Bronze			Cast Bronze		
BONNET		Cast Bronze					Cast Bronze			Cast Bronze			Cast Bronze			Cast Bronze		
STEM		Special Brass					Special Brass			Cast Bronze			Cast Bronze			Cast Bronze		
DISC		Cast Bronze					Cast Bronze			Cast Bronze			Cast Bronze			Cast Bronze		
		Solder end joint					Solder end joint			Solder end joint Non-rising Stem			Solder end joint			Solder end joint Non-rising Stem		

Bronze & Brass

Cast Iron

Ductile Iron

Stainless Steel

Carbon Steel

Butterfly Valve

Ball Valve

Ball Valve Seat

Actuated Valve

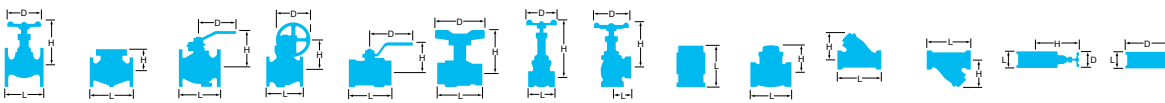

TYPE			GATE			GATE			GATE			GATE			GATE		
Bronze&Brass																	
FIG			C150L			C150LU			AKH			AKFS			AKFH		
PRESSURE			Class 150			Class 150			Class 125			-			Class 125		
END CONNECTION			ASME B16.18			ASME B16.18			NPT			ASME B1.20.1			ASME B1.20.1		
DIMENSIONS	inch	mm	L	H	D	L	H	D	L	H	D	L	H	D	L	H	D
	1/4	8	-	-	-	-	-	-	-	-	-	-	-	-	35	70	50
	3/8	10	-	-	-	-	-	-	42	74	50	38	75	50	38	73	50
	1/2	15	49	137	55	49	137	55	45	80	50	42	75	50	42	73	50
	3/4	20	64	157	70	64	157	70	50	90	55	47	86	55	47	87	55
	1	25	76	180	70	76	180	70	57	105	60	50	97	60	50	97	60
	1 1/4	32	82	216	80	82	216	80	61	118	70	60	117	70	60	118	70
	1 1/2	40	86	257	90	86	257	90	67	135	80	63	126	80	63	126	80
	2	50	109	296	100	109	296	100	74	159	90	72	154	90	72	154	90
	2 1/2	65	-	-	-	-	-	-	90	202	115	80	167	100	82	187	100
	3	80	-	-	-	-	-	-	100	223	135	90	200	115	92	205	115
	4	100	-	-	-	-	-	-	121	280	155	-	-	-	-	-	-
BODY			Cast Bronze			Cast Bronze			Cast Bronze			Forged Brass			Forged Brass		
BONNET			Cast Bronze			Cast Bronze			Cast Bronze			Forged Brass			Forged Brass		
STEM			Cast Bronze			Cast Bronze			Special Brass			Special Brass			Special Brass		
DISC			Cast Bronze			Cast Bronze			Cast Bronze			Forged Brass			Forged Brass		
			Solder end joint			Solder end joint			Non-rising Stem			Non-rising Stem			Non-rising Stem		

TYPE			GATE			GATE			GATE			GATE			GATE		
Bronze&Brass																	
FIG			AK125E			AK125M			AK150E			AK150L			AK150LU		
PRESSURE			Class 125			Class 125			Class 150			Class 150			Class 150		
END CONNECTION			ASME B1.20.1			ASME B1.20.1			BS21 (JIS B0203)			ASME B1.20.1			ASME B1.20.1		
DIMENSIONS	inch	mm	L	H	D	L	H	D	L	H	D	L	H	D	L	H	D
	1/4	8	-	-	-	-	-	-	-	-	-	-	-	-	45	108	50
	3/8	10	43	86	50	-	-	-	43	86	50	-	-	-	46	108	50
	1/2	15	49	93	55	51	129	55	49	98	55	51	137	55	51	137	55
	3/4	20	53	110	60	56	155	60	53	114	70	56	157	70	56	157	70
	1	25	61	126	70	66	180	70	61	126	70	66	180	70	66	180	70
	1 1/4	32	64	145	80	68	216	80	68	145	80	68	216	80	68	216	80
	1 1/2	40	68	170	90	74	257	90	74	176	90	74	257	90	74	257	90
	2	50	74	189	100	84	296	100	84	201	100	84	296	100	84	297	100
	2 1/2	65	-	-	-	115	371	135	-	-	-	120	385	155	-	-	-
	3	80	-	-	-	130	432	155	-	-	-	140	432	155	-	-	-
	4	100	-	-	-	-	-	-	-	-	-	-	-	-	-	-	-
BODY			Cast Bronze			Cast Bronze			Cast Bronze			Cast Bronze			Cast Bronze		
BONNET			Cast Bronze			Cast Bronze			Cast Bronze			Cast Bronze			Cast Bronze		
STEM			Special Brass			Cast Bronze			Cast Bronze			Cast Bronze			Cast Bronze		
DISC			Cast Bronze			Cast Bronze			Cast Bronze			Cast Bronze			Cast Bronze		
			Non-rising Stem						Non-rising Stem								

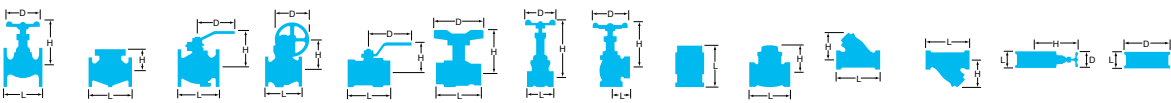

TYPE			GATE			GATE			GATE			GATE			GATE		
Bronze&Brass																	
FIG			AK300LU			AS-FH			PN16S			PN16FH			PN20E		
PRESSURE			Class 300			Class 125			PN16			PN16			PN20		
END CONNECTION			ASME B1.20.1			AS 1722.1			BS21 (JIS B0203)			ASME B1.20.1			BS21 (JIS B0203)		
DIMENSIONS	inch	mm	L	H	D	L	H	D	L	H	D	L	H	D	L	H	D
	1/4	8	-	-	-	-	-	-	-	-	-	35	70	50	-	-	-
	3/8	10	46	125	60	-	-	-	-	-	-	38	73	50	-	-	-
	1/2	15	51	149	70	55	74	55	42	75	50	42	73	50	48	96	55
	3/4	20	56	173	80	60	86	55	47	86	55	47	87	55	53	111	60
	1	25	66	194	80	68	94	60	50	97	60	50	97	60	62	122	70
	1 1/4	32	74	228	100	78	116	70	60	117	70	60	118	70	69	141	80
	1 1/2	40	84	274	115	81	128	80	63	126	80	63	126	80	75	164	90
	2	50	98	313	135	94	158	90	72	154	90	72	154	90	86	197	100
	2 1/2	65	-	-	-	-	-	-	-	-	-	82	187	100	-	-	-
	3	80	-	-	-	-	-	-	-	-	-	92	205	115	-	-	-
	4	100	-	-	-	-	-	-	-	-	-	-	-	-	-	-	-
BODY			Cast Bronze			Dezincification Resistance Brass			Cast Bronze			Forged Brass			Cast Bronze		
BONNET			Cast Bronze			Dezincification Resistance Brass			Forged Brass			Forged Brass			Forged Brass		
STEM			Cast Bronze			Dezincification Resistance Brass			Special Brass			Special Brass			Special Brass		
DISC			Copper-Nickel Alloy			Dezincification Resistance Brass			Forged Brass			Forged Brass			Cast Bronze		
						Non-rising Stem			Non-rising Stem			Non-rising Stem			Non-rising Stem		

TYPE			GATE			GLOBE			GLOBE			GLOBE			GLOBE		
Bronze&Brass																	
FIG			PN25H			A			Q			QA			G		
PRESSURE			PN25			Class 100			Class 100			Class 100			Class 125		
END CONNECTION			BS21 (JIS B0203)			BS21 (JIS B0203)			BS21			BS21 (JIS B0203)			BS21		
DIMENSIONS	inch	mm	L	H	D	L	H	D	L	H	D	L	H	D	L	H	D
	1/4	8	-	-	-	40	66	50	-	-	-	-	-	-	47	68	50
	3/8	10	-	-	-	42	67	50	-	-	-	-	-	-	53	88	55
	1/2	15	45	80	50	48	69	55	44	70	50	44	70	50	57	100	60
	3/4	20	50	90	55	53	80	60	50	73	55	50	73	55	66	110	70
	1	25	57	105	60	63	94	70	63	86	60	63	86	60	76	120	80
	1 1/4	32	61	118	70	73	104	80	-	-	-	73	108	80	88	140	90
	1 1/2	40	67	135	80	81	127	90	-	-	-	81	132	90	100	156	100
	2	50	74	159	90	94	147	100	-	-	-	94	150	100	120	185	115
	2 1/2	65	-	-	-	115	179	115	-	-	-	-	-	-	147	210	135
	3	80	-	-	-	131	200	135	-	-	-	-	-	-	162	229	155
	4	100	-	-	-	171	250	180	-	-	-	-	-	-	-	-	-
BODY			Cast Bronze			Cast Bronze			Cast Bronze			Cast Bronze			Cast Bronze		
BONNET			Cast Bronze			Forged Brass			Forged Brass			Forged Brass			Forged Brass		
STEM			Special Brass			Special Brass			Special Brass			Special Brass			Special Brass		
DISC			Special Brass			Cast Bronze			Uletan Rubber			PTFE			G/F PTFE		
			Non-rising Stem						Soft Seated disc			Soft Seated disc			Soft Seated disc		

Bronze & Brass

Cast Iron

Ductile Iron

Stainless Steel

Carbon Steel

Buttery Valve

Ball Valve

Ball Valve Seat

Actuated Valve

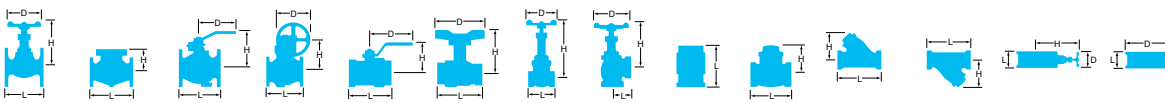

TYPE		GLOBE			GLOBE			GLOBE			GLOBE			GLOBE			
Bronze&Brass																	
FIG		C			CA			B			BH			D			
PRESSURE		Class 150			Class 150			Class 150			Class 150			Class 150			
END CONNECTION		BS21 (JIS B0203)			BS21			JIS B2240			JIS B2240			BS21			
DIMENSIONS	inch	mm	L	H	D	L	H	D	L	H	D	L	H	D	L	H	D
	1/4	8	44	66	50	21	66	50	-	-	-	-	-	-	-	-	-
	3/8	10	44	68	50	24	68	50	-	-	-	-	-	-	-	-	-
	1/2	15	53	79	60	28	79	60	83	79	60	83	79	60	64	113	60
	3/4	20	65	93	70	34	93	70	88	94	70	88	94	70	78	138	90
	1	25	77	104	80	40	104	80	100	105	80	100	105	80	90	156	100
	1 1/4	32	85	127	90	47	127	90	113	127	90	113	127	90	105	184	115
	1 1/2	40	100	145	100	52	145	100	120	145	100	120	145	100	120	187	115
	2	50	119	174	115	61	174	115	145	174	115	145	174	115	145	212	135
	2 1/2	65	139	199	135	74	199	135	165	198	135	165	198	135	-	-	-
	3	80	158	215	155	85	215	155	177	215	155	177	215	155	-	-	-
	4	100	-	-	-	-	-	-	220	250	180	220	250	180	-	-	-
BODY		Cast Bronze			Cast Bronze			Cast Bronze			Cast Bronze			Cast Bronze			
BONNET		Forged Brass			Forged Brass			Forged Brass			Forged Brass			Forged Brass			
STEM		Special Brass			Special Brass			Special Brass			Special Brass			Special Brass			
DISC		Cast Bronze			Cast Bronze			Cast Bronze			Cast Bronze			G/F PTFE			
								Framed ends undrilled						Soft Seated disc			

TYPE		GLOBE			GLOBE			GLOBE			GLOBE			GLOBE			
Bronze&Brass																	
FIG		DB			DBH			K			J			JB			
PRESSURE		Class 150			Class 150			5K			10K			10K			
END CONNECTION		JIS B2240			JIS B2240			BS21 (JIS B0203)			BS21 (JIS B0203)			JIS B2011			
DIMENSIONS	inch	mm	L	H	D	L	H	D	L	H	D	L	H	D	L	H	D
	1/4	8	-	-	-	-	-	-	-	-	-	50	86	50	-	-	-
	3/8	10	-	-	-	-	-	-	50	87	55	55	87	55	-	-	-
	1/2	15	82	113	60	82	113	60	60	90	60	65	93	60	85	93	60
	3/4	20	95	138	90	95	138	90	70	102	70	80	122	80	95	122	80
	1	25	108	156	100	108	156	100	80	112	80	90	135	90	110	135	90
	1 1/4	32	120	184	115	120	184	115	100	137	90	105	157	100	130	157	100
	1 1/2	40	140	187	115	140	187	115	110	142	100	120	171	115	150	171	115
	2	50	165	212	135	165	212	135	135	173	115	140	196	135	180	196	135
	2 1/2	65	190	244	155	190	244	155	160	203	135	180	232	155	210	232	155
	3	80	220	281	180	220	281	180	190	233	155	200	268	180	240	268	180
	4	100	270	321	225	270	321	225	-	-	-	-	-	-	280	323	225
BODY		Cast Bronze			Cast Bronze			Cast Bronze			Cast Bronze			Cast Bronze			
BONNET		Forged Brass			Forged Brass			Forged Brass			Forged Brass			Forged Brass			
STEM		Special Brass			Special Brass			Special Brass			Special Brass			Special Brass			
DISC		G/F PTFE			G/F PTFE			Cast Bronze			Cast Bronze			Cast Bronze			
		Soft Seated disc Framed ends undrilled			Soft Seated disc												

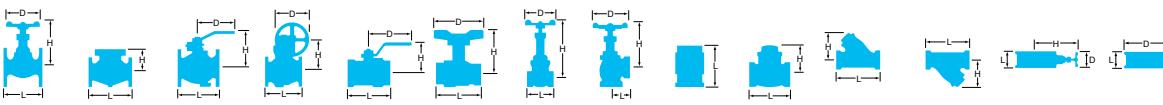

TYPE		GLOBE					GLOBE			GLOBE			GLOBE			GLOBE		
Bronze&Brass																		
FIG		150D					300D			C125C			C150D			AKA		
PRESSURE		Class 150					Class 300			Class 125			Class 150			Class 100		
END CONNECTION		BS21 (JIS B0203)					BS21 (JIS B0203)			ASME B16.18			ASME B16.18			ASME B1.20.1		
DIMENSIONS	inch	mm	L	H	D	L	H	D	L	H	D	L	H	D	L	H	D	
	1/4	8	53	109	60	53	113	60	—	—	—	58	109	60	40	66	50	
	3/8	10	55	109	60	55	113	60	—	—	—	61	109	60	42	67	50	
	1/2	15	64	116	70	64	126	80	64	76	60	72	116	70	48	69	55	
	3/4	20	78	136	90	78	139	90	84	98	70	95	136	90	53	80	60	
	1	25	90	149	100	90	157	100	100	108	80	112	149	100	63	94	70	
	1 1/4	32	105	173	115	105	187	115	115	137	90	126	173	115	73	104	80	
	1 1/2	40	120	182	115	120	192	135	130	160	100	145	182	115	81	127	90	
	2	50	145	209	135	145	221	155	155	180	115	180	209	135	94	147	100	
	2 1/2	65	—	—	—	—	—	—	192	202	135	205	247	155	115	179	115	
	3	80	—	—	—	—	—	—	232	246	155	244	275	180	131	200	135	
	4	100	—	—	—	—	—	—	—	—	—	312	298	225	171	250	180	
BODY		Cast Bronze					Cast Bronze			Cast Bronze			Cast Bronze			Cast Bronze		
BONNET		Cast Bronze					Cast Bronze			Forged Brass			Cast Bronze			Forged Brass		
STEM		Cast Bronze					Cast Bronze			Cast Bronze			Cast Bronze			Special Brass		
DISC		G/F PTFE					G/F PTFE			Cast Bronze			G/F PTFE			Cast Bronze		
		Soft Seated disc					Soft Seated disc			Solder end joint			Soft Seated disc Solder end joint					

TYPE		GLOBE					GLOBE			GLOBE			GLOBE			GLOBE		
Bronze&Brass																		
FIG		AKG					AKC			AKCA			AK125C			AK150D		
PRESSURE		Class 125					Class 150			Class 150			Class 125			Class 150		
END CONNECTION		ASME B1.20.1					ASME B1.20.1			ASME B1.20.1			ASME B1.20.1			ASME B1.20.1		
DIMENSIONS	inch	mm	L	H	D	L	H	D	L	H	D	L	H	D	L	H	D	
	1/4	8	47	68	50	44	66	50	21	66	50	—	—	—	53	109	60	
	3/8	10	53	88	55	44	68	50	24	68	50	—	—	—	55	109	60	
	1/2	15	57	100	60	53	79	60	28	79	60	53	76	60	64	116	70	
	3/4	20	66	110	70	65	93	70	34	93	70	65	98	70	78	136	90	
	1	25	76	120	80	77	104	80	40	104	80	77	108	80	90	149	100	
	1 1/4	32	88	140	90	85	127	90	47	127	90	85	137	90	105	173	115	
	1 1/2	40	100	156	100	100	145	100	52	145	100	100	160	100	120	182	115	
	2	50	120	185	115	119	174	115	61	174	115	119	180	115	145	209	135	
	2 1/2	65	147	210	135	139	199	135	74	199	135	150	202	135	170	247	155	
	3	80	162	229	155	158	215	155	85	215	155	178	246	155	200	275	180	
	4	100	—	—	—	—	—	—	—	—	—	—	—	—	245	298	225	
BODY		Cast Bronze					Cast Bronze			Cast Bronze			Cast Bronze			Cast Bronze		
BONNET		Forged Brass					Forged Brass			Forged Brass			Forged Brass			Cast Bronze		
STEM		Special Brass					Special Brass			Special Brass			Cast Bronze			Cast Bronze		
DISC		G/F PTFE					Cast Bronze			Cast Bronze			Cast Bronze			G/F PTFE		
		Soft Seated disc														Soft Seated disc		

Bronze & Brass

Cast Iron

Ductile Iron

Stainless Steel

Carbon Steel

Butterfly Valve

Ball Valve

Ball Valve Seat

Actuated Valve

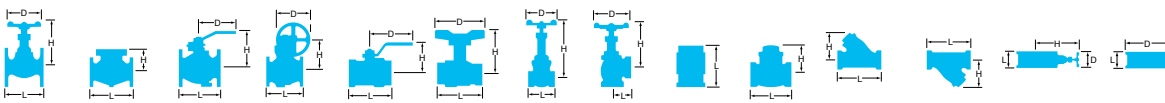

TYPE		GLOBE			GLOBE			GLOBE			GLOBE			GLOBE			
Bronze&Brass																	
FIG		AK300D			AK300J			PN16A			PN16G			PN20D			
PRESSURE		Class 300			Class 300			PN16			PN16			PN20			
END CONNECTION		ASME B1.20.1			ASME B1.20.1			BS21 (JIS B0203)			BS21 (JIS B0203)			BS21 (JIS B0203)			
DIMENSIONS	inch	mm	L	H	D	L	H	D	L	H	D	L	H	D	L	H	D
	1/4	8	53	113	60	53	113	60	—	—	—	—	—	—	—	—	—
	3/8	10	55	113	60	55	113	60	—	—	—	—	—	—	—	—	—
	1/2	15	64	126	80	64	126	80	48	69	55	57	100	60	64	113	60
	3/4	20	78	139	90	78	139	90	53	80	60	66	110	70	78	138	90
	1	25	90	157	100	90	159	100	63	94	70	76	120	80	90	156	100
	1 1/4	32	105	187	115	105	187	115	73	104	80	88	140	90	105	184	115
	1 1/2	40	120	192	135	120	195	135	81	127	90	100	156	100	120	187	115
	2	50	145	221	155	145	224	155	94	147	100	120	185	115	145	212	135
	2 1/2	65	—	—	—	—	—	—	—	—	—	—	—	—	—	—	—
	3	80	—	—	—	—	—	—	—	—	—	—	—	—	—	—	—
	4	100	—	—	—	—	—	—	—	—	—	—	—	—	—	—	—
BODY		Cast Bronze			Cast Bronze			Cast Bronze			Cast Bronze			Cast Bronze			
BONNET		Cast Bronze			Cast Bronze			Cast Bronze			Cast Bronze			Cast Bronze			
STEM		Cast Bronze			Cast Bronze			Cast Bronze			Cast Bronze			Cast Bronze			
DISC		G/F PTFE			Cast Bronze			Cast Bronze			Cast Bronze			G/F PTFE			
		Soft Seated disc									Soft Seated disc			Soft Seated disc			

TYPE		GLOBE			LIFT CHECK			SWING CHECK			SWING CHECK			SWING CHECK			
Bronze&Brass																	
FIG		PN25C			F			R			O			OB			
PRESSURE		PN25			Class 150			Class 125			10K			10K			
END CONNECTION		BS21 (JIS B0203)			BS21 (JIS B0203)			BS21 (JIS B0203)			JIS B0203			JIS B2240			
DIMENSIONS	inch	mm	L	H	D	L	H	D	L	H	D	L	H	D	L	H	D
	1/4	8	—	—	—	—	—	—	—	—	—	—	—	—	—	—	—
	3/8	10	—	—	—	44	26	23	53	39	23	55	38.5	24	—	—	—
	1/2	15	53	79	60	53	28	28	60	39	28	65	43	29	85	43	95
	3/4	20	65	93	70	65	34	35	70	45	35	80	51.5	35	95	52	100
	1	25	77	104	80	77	42	43	80	52	43	90	58.5	44	110	59	125
	1 1/4	32	85	127	90	85	50	52	92	62	52	105	67	54	130	67	135
	1 1/2	40	100	145	100	100	56	59	102	67	59	120	73.5	60	150	74	140
	2	50	119	174	115	119	67	72	122	79	72	140	86	74	180	86	155
	2 1/2	65	—	—	—	139	79	88	150	91	87	180	97	90	210	97	175
	3	80	—	—	—	158	91	105	165	102	102	200	108	103	240	108	185
	4	100	—	—	—	—	—	—	195	119	127	—	—	—	280	127	210
BODY		Cast Bronze			Cast Bronze			Cast Bronze			Cast Bronze			Cast Bronze			
BONNET		Forged Brass			—			—			—			—			
CAP		—			Brass			Brass			Brass			Brass			
STEM		Special Brass			—			—			—			—			
HINGE PIN		—			—			Brass Rod			Brass Rod			Brass Rod			
DISC		Cast Bronze			Cast Bronze			Forged Brass			Cast Bronze			Cast Bronze			



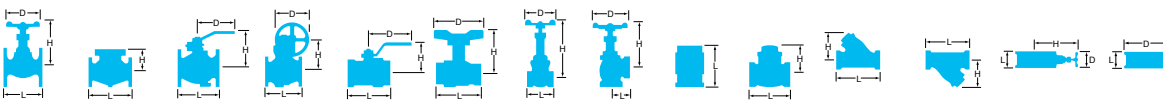







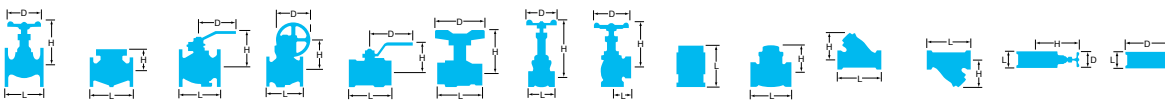



TYPE		SWING CHECK			WAFER CHECK			LIFT CHECK			LIFT CHECK			FOOT CHECK			
Bronze&Brass																	
FIG		YR			10BWZ			RF			VF			FT			
PRESSURE		Class 125			10K			10K			-			-			
END CONNECTION		BS21 (JIS B0203)			Wafer Type			BS21 (JIS B0203)			BS21			BS21 (JIS B0203)			
DIMENSIONS	inch	mm	L	H	D	L	H	D	L	H	D	L	H	D	L	H	D
	3/8	10	54	40	23	-	-	-	-	-	-	-	-	-	-	-	-
	1/2	15	56	40	28	-	-	-	53	-	28	37	-	24	-	-	-
	3/4	20	70	49	34	-	-	-	59	-	34	44	-	30	48	-	41
	1	25	80	58	41	-	-	-	67	-	41	51	-	36	58	-	52
	1 1/4	32	95	71	50	-	-	-	78	-	50	62	-	45	62	-	62
	1 1/2	40	110	80	57	54	132	55	84	-	57	69	-	52	70	-	70
	2	50	128	95	70	56	139	70	98	-	70	82	-	63	80	-	83
	2 1/2	65	-	-	-	56	146	70	-	-	-	-	-	-	90	-	102
	3	80	-	-	-	59	152	70	-	-	-	-	-	-	100	-	116
	4	100	-	-	-	66	165	70	-	-	-	-	-	-	-	-	-
	5	125	-	-	-	72	183	70	-	-	-	-	-	-	-	-	-
	6	150	-	-	-	78	208	80	-	-	-	-	-	-	-	-	-
	8	200	-	-	-	96	237	80	-	-	-	-	-	-	-	-	-
	10	250	-	-	-	109	289	90	-	-	-	-	-	-	-	-	-
	12	300	-	-	-	145	316	90	-	-	-	-	-	-	-	-	-
BODY		Bronze			Cast Bronze+NBR			Cast Bronze			Cast Bronze			Cast Bronze			
CAP		Brass			-			Bronze			Brass / Bronze			Bronze			
HINGE PIN		Copper			SUS304			-			-			-			
DISC		Bronze			Cast Bronze			NBR			Special Brass			NBR			
								Soft Seated disc						Soft Seated disc			

TYPE		FOOT CHECK			SWING CHECK			SWING CHECK			SWING CHECK			SWING CHECK			
Bronze&Brass																	
FIG		FTS			150YR			300YR			CR			CYR			
PRESSURE		-			Class 150			Class 300			Class 125			Class 125			
END CONNECTION		BS21 (JIS B0203)			BS21 (JIS B0203)			BS21			JIS B2011 / ASME B16.18(21/2 & 3)			ASME B16.18			
DIMENSIONS	inch	mm	L	H	D	L	H	D	L	H	D	L	H	D	L	H	D
	1/4	8	-	-	-	-	-	-	-	-	-	-	-	-	-	-	-
	3/8	10	-	-	-	54	39	23	-	-	-	56	39	-	-	-	-
	1/2	15	-	-	-	60	39	27	60	42	29	67	39	-	67	38	-
	3/4	20	25	-	31	72	49	33	72	51	35	89	45	-	86	47	-
	1	25	29	-	38	84	58	41	84	61	44	104	52	-	105	56	-
	1 1/4	32	32	-	47	99	70	51	99	74	54	120	62	-	121	69	-
	1 1/2	40	35	-	53	113	79	58	113	83	60	134	67	-	137	77	-
	2	50	43	-	66	131	95	71	131	98	74	164	79	-	170	92	-
	2 1/2	65	50	-	81	-	-	-	-	-	-	193	91	-	194	111	-
	3	80	51	-	94	-	-	-	-	-	-	213	102	-	222	127	-
	4	100	-	-	-	-	-	-	-	-	-	-	-	-	-	-	-
BODY		Cast Bronze			Cast Bronze			Cast Bronze			Cast Bronze			Cast Bronze			
CAP		-			Brass			Brass			Brass			Brass			
HINGE PIN		-			Copper			Copper			Copper			Copper			
DISC		NBR			Cast Bronze			Cast Bronze			Forged Brass			Cast Bronze			
		Soft Seated disc									Solder end joint			Solder end joint			

Bronze & Brass  
 Cast Iron  
 Ductile Iron  
 Stainless Steel  
 Carbon Steel  
 Battery Valve  
 Ball Valve  
 Ball Valve Seat  
 Actuated Valve



TYPE		SWING CHECK			LIFT CHECK			SWING CHECK			SWING CHECK			SWING CHECK			
Bronze&Brass																	
FIG		C150YR			CAF			AKYR			AK150YR			AK300YR			
PRESSURE		Class 150			Class 150			Class 125			Class 150			Class 300			
END CONNECTION		ASME B16.18			ASME B16.18			ASME B1.20.1			ASME B1.20.1			ASME B1.20.1			
DIMENSIONS	inch	mm	L	H	D	L	H	D	L	H	D	L	H	D	L	H	D
	1/4	8	—	—	—	—	—	—	—	—	—	—	—	—	—	—	—
	3/8	10	61	39	—	—	—	—	—	—	—	54	39	—	—	—	—
	1/2	15	67	39	—	61	—	—	56	40	—	60	39	—	60	42	—
	3/4	20	86	49	—	76	—	—	70	49	—	72	49	—	72	51	—
	1	25	105	58	—	89	—	—	80	58	—	84	58	—	84	61	—
	1 1/4	32	121	70	—	97	—	—	95	71	—	99	70	—	99	74	—
	1 1/2	40	137	79	—	110	—	—	110	80	—	113	79	—	113	83	—
	2	50	170	95	—	132	—	—	128	95	—	131	95	—	131	98	—
	2 1/2	65	194	114	—	—	—	—	156	114	—	162	114	—	—	—	—
	3	80	222	132	—	—	—	—	184	131	—	186	132	—	—	—	—
	4	100	—	—	—	—	—	—	—	—	—	—	—	—	—	—	—
BODY		Cast Bronze			Cast Bronze			Cast Bronze			Cast Bronze			Cast Bronze			
CAP		Brass			Cast Bronze			Brass			Brass			Brass			
HINGE PIN		Copper			—			Copper			Copper			Copper			
DISC		Cast Bronze			—			Cast Bronze			Cast Bronze			Cast Bronze			
SEAT		—			FKM			—			—			—			
		Solder end joint			Solder end joint												

TYPE		LIFT CHECK			SWING CHECK			SWING CHECK			LIFT CHECK			Y TYPE STRAINER			
Bronze&Brass																	
FIG		AKAF			PN16R			PN16YR			PN25F			Y			
PRESSURE		Class 150			PN16			PN16			PN25			10K			
END CONNECTION		ASME B1.20.1			BS21 (JIS B0203)			ASME B1.20.1			BS21 (JIS B0203)			BS21 (JIS B0203)			
DIMENSIONS	inch	mm	L	H	D	L	H	D	L	H	D	L	H	D	L	H	D
	1/4	8	—	—	—	—	—	—	—	—	—	—	—	—	—	—	—
	3/8	10	—	—	—	—	—	—	—	—	—	—	—	—	70	44	—
	1/2	15	53	26	—	60	39	—	56	40	28	53	28	28	80	49	—
	3/4	20	59	32	—	70	45	—	70	49	35	65	34	35	100	57	—
	1	25	67	39	—	80	52	—	80	58	43	77	42	43	115	70	—
	1 1/4	32	78	48	—	92	62	—	95	71	52	85	50	52	135	82	—
	1 1/2	40	84	54	—	102	67	—	110	80	59	100	56	59	160	98	—
	2	50	98	67	—	122	79	—	128	95	72	119	67	72	195	121	—
	2 1/2	65	—	—	—	—	—	—	—	—	—	—	—	—	230	148	—
	3	80	—	—	—	—	—	—	—	—	—	—	—	—	240	180	—
	4	100	—	—	—	—	—	—	—	—	—	—	—	—	—	—	—
BODY		Cast Bronze			Cast Bronze			Cast Bronze			Cast Bronze			Cast Bronze			
CAP		—			Brass			Brass			Brass			Brass			
HINGE PIN		—			Forged Brass			Copper			—			—			
DISC		—			Forged Brass			Cast Bronze			Cast Bronze			—			
SEAT		FKM			—			—			—			—			
SCREEN		—			—			—			—			SUS304			

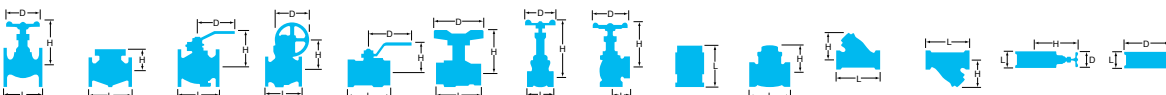

TYPE		Y TYPE STRAINER				Y TYPE STRAINER			Y TYPE STRAINER			
Bronze&Brass												
FIG		CY				AKY			PN25Y			
PRESSURE		10K				Class 150			PN25			
END CONNECTION		Solder Joint				ASME B1.20.1			BS21 (JIS B0203)			
DIMENSIONS		inch	mm	L	H	D	L	H	D	L	H	D
	1/4	8	—	—	—	—	—	—	—	—	—	—
	3/8	10	—	—	—	70	44	—	—	—	—	—
	1/2	15	80	49	—	80	49	—	80	49	—	—
	3/4	20	105	57	—	100	57	—	100	57	—	—
	1	25	125	70	—	115	70	—	115	70	—	—
	1 1/4	32	145	82	—	135	82	—	135	82	—	—
	1 1/2	40	170	98	—	160	98	—	160	98	—	—
	2	50	210	121	—	195	121	—	195	121	—	—
	2 1/2	65	250	148	—	—	—	—	—	—	—	—
	3	80	280	180	—	—	—	—	—	—	—	—
	4	100	—	—	—	—	—	—	—	—	—	—
BODY		Bronze				Cast Bronze			Cast Bronze			
CAP		Brass				Brass			Brass			
STEM		—				—			—			
DISC		—				—			—			
SCREEN		SUS304				SUS304			SUS304			
		Solder end joint										

Bronze & Brass

Cast Iron

Ductile Iron

Stainless Steel

Carbon Steel

Butterfly Valve

Ball Valve

Ball Valve Seat

Actuated Valve

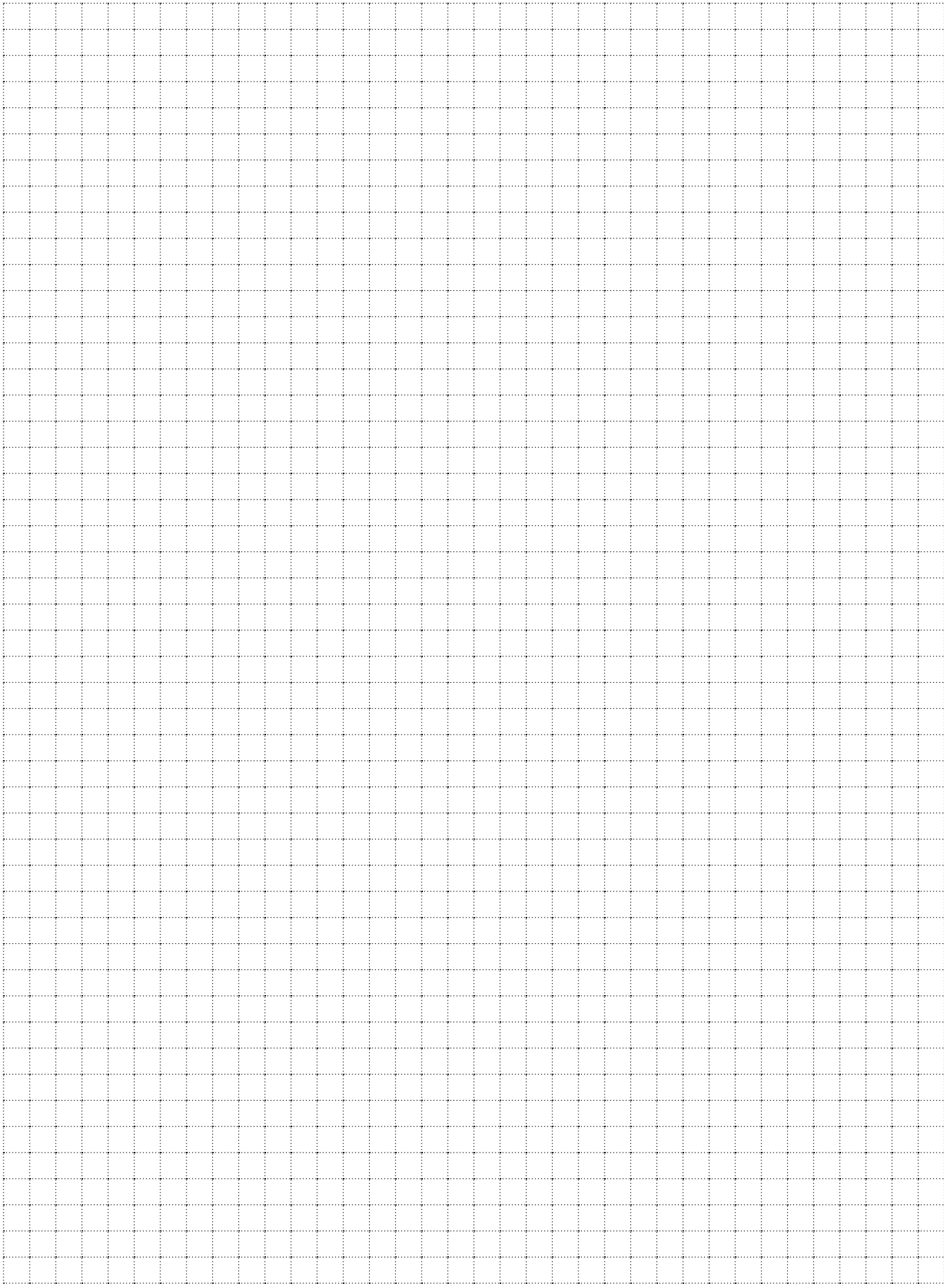

# CAST IRON

# Cast Iron

## Basic Design Specifications

Class	JIS5K/10K	Class 100/125
Face to face dimension	JIS B2031	ASME B16.10
End flange dimension		ASME B16.1
Wall thickness		KITZ Std.

\*Please refer to our website (www.kitz.co.jp) or contact KITZ for details.

## Material Specifications for Grey Iron Casting

Mechanical Properties	JIS materials		
	FC200	FC250	FC300
Tensile strength (N/mm <sup>2</sup> ) min.	200	250	300
Brinell hardness (HB) max.	235	248	269
ASTM A126 Class B	Tensile strength (min)		31ksi
Transverse test requirement	Face at center, min.		3,300 lb
	Deflection at center, min.		0.12in

## ASME Valves Pressure-Temperature Ratings

### Maximum Allowable Non-Shock Pressure

Service temperature		Class 125				
		Size 2" to 12"		Size 14" to 24"		
°F	°C	Psi.	MPa	Psi.	MPa	
-20 to 150	-29 to 66	200	1.37	150	1.03	
200	93	190	1.30	135	0.93	
225	107	180	1.24	130	0.89	
250	121	175	1.20	125	0.86	
275	135	170	1.17	120	0.82	
300	149	165	1.13	110	0.75	
325	163	155	1.06	105	0.72	
350	177	150	1.03	100	0.69	
375	191	145	1.00			
400	204	140	0.96			
425	218	130	0.89			
450	232	125	0.86			
Saturated steam		125	0.86	100	0.69	
Test Pressure	Hydro-static	Shell	350	2.41	265	1.83
		Seat	220	1.51	165	1.13
	Air	Seat	80	0.59	80	0.59

### Remarks:

- (1) All pressures are given in pounds per square inch gage (PSIG).
- (2) Pressure-temperature ratings extracted from MSS SP-70, 71, 85 apply to iron flanged end valves designed for primary working pressures in Class 125.

## JIS Valves Pressure-Temperature Ratings MPa

Service temperature °C (°F)	5K	10K	10K	
	All Sizes	Sizes 2" to 12"	Sizes 14" to 24"	FC300 all sizes
120°(248°) non-shock water	0.69	1.37	0.98	0.98
120°(248°) oil, water, air	0.49	0.98	0.86	0.86
Saturated steam	0.20	0.69/0.20	0.69	0.69

\*Inside screw gate valves only.

## PN Series Valves Pressure-Temperature Ratings

### Maximum permissible working pressure (bar)

Service temperature (°C)	Cast iron valves	
	PN16	
-10 to 66		
100	16	
120		
150	14.4	
170	13.7	
180	13.4	
186	13.2	
198	12.9	
200	12.8	

(Note) : Intermediate values may be obtained by linear interpolation.

## Simplified Material Indication (as referred to in each page)

**Bronze trim** : Iron body with bronze trim

**13 Cr. trim** : Iron body with 13 Cr. trim

**18-8 trim** : Iron body with 18 Cr.-8 Ni trim

## Certification by JIS Mark

Industrial Standardization Law of Japan provides an effective measure to promote introduction of high level quality assurance system of manufacture and processing. Wherever KITZ valves are identified with JIS Mark, it is officially certified that such valves are produced under strict quality assurance procedures and practices to satisfy the designated quality level stably and constantly.

## Valve Position Indicators



A valve position indicator is provided on gate valves with inside screw design as illustrated here. Opening or closing valves does not move the vertical position of the hand-wheel. Instead, the position indicator visually indicates three valve operating positions-fully opened, fully closed or half opened.

## Trim Materials

KITZ cast iron valves are provided with either one of the three trim materials tabled below for versatility of service applications.

Color coding is made on a spoke of the handwheel of gate or globe valves and on the cover of swing check valves.

Trim material	Color coding	Suffix of Fig.
■ Bronze seats / Brass stem	None	—
■ 13 Cr. seats / stem	Yellow	S
■ 18-8 seats / stem	Red	U

## Outside Screw (O.S.) Valves and Inside Screw (I.S.) Valves

### Outside Screw Gate Valve

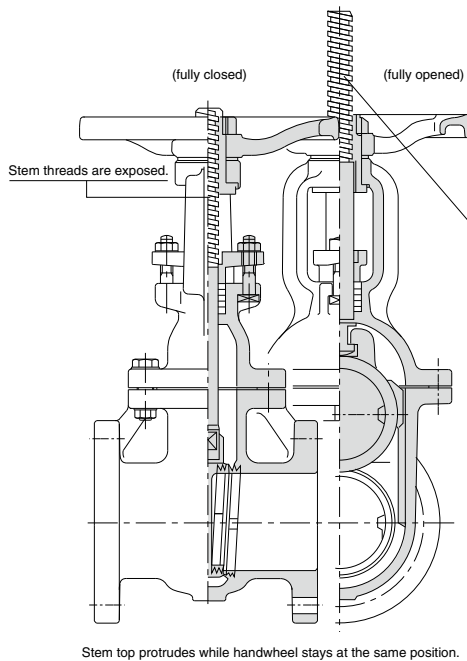

### Inside Screw Gate Valve

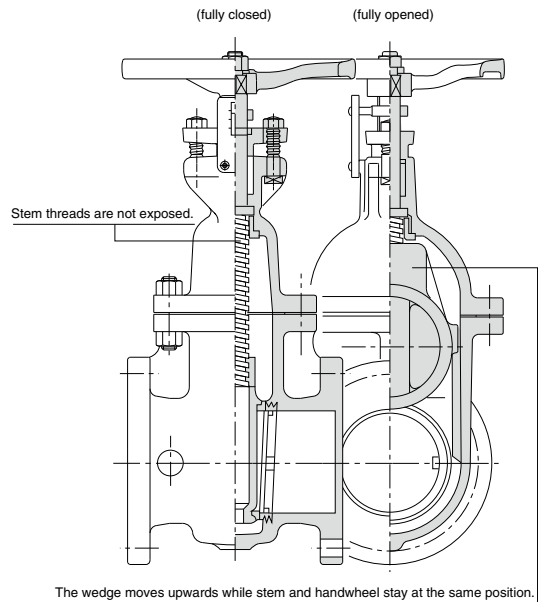

### Outside Screw Gate Valves

Stem threads are exposed to the air, and valve opening operation moves the stem upwards while the handwheel stays at the same position. Valve operating position can be visually known by observing stem travel. KITZ Fig. FCM, FCL, FCLS and FCLU are designed this way.

### Outside Screw Globe Valves

The stem and handwheel move upwards or downwards at the same time, following valve opening or closing operation. All KITZ globe valves are provided with this design.

### Inside Screw Gate Valves

Stem threads are not exposed to the air and valve opening operation does not make movement of the stem or handwheel so that valve operating position is not visible. A position indicator is provided for this reason.

Inside screw gate valves are generally designed shorter than outside screw gate valves and the stem and handwheel stay always at the same position. For this feature, inside screw gate valves are widely employed for underground installation or service in narrow areas with limited room. KITZ Fig. FCW and FCHI are designed this way.

### Asbestos-free Packings and Gaskets

KITZ has led the industry in employing asbestos-free sealers for all cast iron valves, meeting the requirement of pollution-free valve materials. PTFE impregnated glass fiber gland packings and compressed glass and aramid fiber gaskets are the standard sealers for KITZ cast iron valves.

### Product Coding

**125 FC L S**

1 2 3 4

#### 1 Valve class

100 ..... Class 100  
125 ..... Class 125  
5 ..... JIS 5K  
10 ..... JIS 10K  
EN16 ..... PN16

#### 2 Symbol of shell material

FC ..... Cast Iron

#### 3 Type of valve

L ..... Gate valve  
WI & HI ... Gate valve with indicator  
J ..... Globe valve  
O ..... Check valve  
TB ..... Full port ball valve  
TR ..... Reduced port ball valve

#### 4 Trim material

None ... Bronze trim  
U ..... Type 304 stainless steel  
S ..... Type 403 stainless steel  
M ..... Type 316 stainless steel

#### NOTE

B.B. .... Bolted bonnet      I.S. .... Inside screw  
O.S.&Y ... Outside screw & yoke      N.R.S. .... Non-rising stem

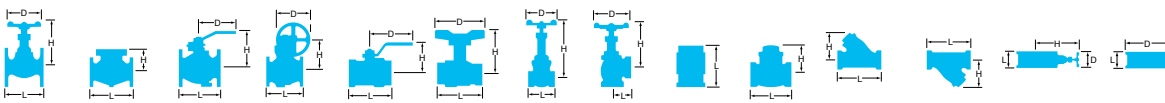

TYPE		GATE			GATE			GATE			GATE			GATE			
Cast Iron																	
FIG		10FCHI			10FCL			10FCLS			125FCHI			125FCL			
PRESSURE		10K			10K			10K			Class 125			Class 125			
END CONNECTION		JIS B2239			JIS B2239			JIS B2239			ASME B16.1			ASME B16.1			
DIMENSIONS	inch	mm	L	H	D	L	H	D	L	H	D	L	H	D	L	H	D
1½	40	140	210	140	165	306	160	165	306	160	140	210	140	—	—	—	—
2	50	146	250	140	180	343	170	180	343	170	146	250	140	178	328	160	160
2½	65	159	285	160	190	389	170	190	389	170	159	285	160	190	382	170	170
3	80	165	350	160	200	462	200	200	462	200	165	350	160	203	436	170	170
4	100	171	400	180	230	547	250	230	547	250	171	400	180	229	532	225	225
5	125	190	460	225	250	648	280	250	648	280	190	465	225	254	627	225	225
6	150	210	515	225	270	759	300	270	759	300	210	515	225	267	726	250	250
8	200	241	635	300	290	956	350	290	956	350	241	630	300	292	919	280	280
10	250	273	760	350	330	1168	400	330	1168	400	—	—	—	330	1134	350	350
12	300	305	870	350	350	1363	450	350	1363	450	—	—	—	356	1363	450	450
14	350	—	—	—	381	1560	500	381	1560	500	—	—	—	381	1560	500	500
16	400	—	—	—	—	—	—	406	1795	600	—	—	—	—	—	—	—
18	450	—	—	—	—	—	—	432	1995	600	—	—	—	—	—	—	—
20	500	—	—	—	—	—	—	457	2230	680	—	—	—	—	—	—	—
22	550	—	—	—	—	—	—	508	2640	760	—	—	—	—	—	—	—
BODY		Cast Iron			Cast Iron			Cast Iron			Cast Iron			Cast Iron			
BONNET		Cast Iron			Cast Iron			Cast Iron			Cast Iron			Cast Iron			
STEM		Forged Brass			Forged Brass			SUS403			Forged Brass			Forged Brass			
DISC		Cast Iron			Cast Iron			Cast Iron			Cast Bronze			Cast Bronze			
SEAT		—			—			BS:SUS403			—			—			

TYPE		GATE			GATE			GLOBE			GLOBE			GLOBE			
Cast Iron																	
FIG		125FCLS			125FCWI			10FCJ			10FCJS			125FCJ			
PRESSURE		Class 125			Class 125			10K			10K			Class 125			
END CONNECTION		ASME B16.1			ASME B16.1			JIS B2239			JIS B2239			ASME B16.1			
DIMENSIONS	inch	mm	L	H	D	L	H	D	L	H	D	L	H	D	L	H	D
1½	40	—	—	—	—	—	—	—	190	260	160	190	260	160	—	—	—
2	50	178	328	160	178	250	140	200	277	180	200	277	180	203	277	180	180
2½	65	190	382	170	190	285	160	220	307	180	220	307	180	216	307	180	180
3	80	203	436	170	203	350	160	240	353	225	240	353	225	241	353	225	225
4	100	229	532	225	229	400	180	290	404	280	290	404	280	292	404	280	280
5	125	254	627	225	254	465	225	360	467	300	360	454	300	330	467	300	300
6	150	267	726	250	267	515	225	410	533	350	410	533	350	356	533	350	350
8	200	292	919	280	292	630	300	500	642	450	500	642	450	495	620	450	450
10	250	330	1134	350	330	760	350	—	—	—	620	665	450	—	—	—	—
12	300	356	1363	450	356	870	350	—	—	—	700	883	500	—	—	—	—
14	350	381	1560	500	—	—	—	—	—	—	—	—	—	—	—	—	—
16	400	—	—	—	—	—	—	—	—	—	—	—	—	—	—	—	—
18	450	—	—	—	—	—	—	—	—	—	—	—	—	—	—	—	—
20	500	—	—	—	—	—	—	—	—	—	—	—	—	—	—	—	—
22	550	—	—	—	—	—	—	—	—	—	—	—	—	—	—	—	—
BODY		Cast Iron			Cast Iron			Cast Iron			Cast Iron			Cast Iron			
BONNET		Cast Iron			Cast Iron			Cast Iron			Cast Iron			Cast Iron			
STEM		SUS403			Forged Brass			Forged Brass			SUS403			Forged Brass			
DISC		Cast Bronze			Cast Iron			Cast Bronze			Cast Bronze			Cast Bronze			



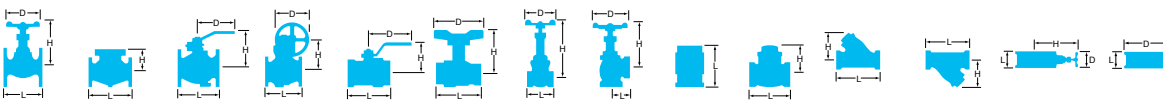

TYPE		GLOBE			SWING CHECK			SWING CHECK			SWING CHECK			WAFER CHECK			
Cast Iron																	
FIG		125FCJS			10FCO			10FCOC			125FCO			10FWZ			
PRESSURE		Class 125			10K			10K			Class 125			10K			
END CONNECTION		ASME B16.1			JIS B2220			JIS B2220			ASME B16.1			Wafer Type			
DIMENSIONS		inch	mm	L	H	D	L	H	D	L	H	D	L	H	D		
Cast Iron	1 1/2	40	—	—	—	190	106	140	—	—	—	—	54	128	55		
	2	50	203	277	180	200	111	155	200	116	155	203	111	152	56	143	70
	2 1/2	65	216	307	180	220	121	175	220	126	175	216	121	178	56	150	70
	3	80	241	353	225	240	145	185	240	153	185	241	145	190	59	156	70
	4	100	292	404	280	290	165	210	290	170	210	292	165	229	66	169	70
	5	125	330	467	300	360	207	250	360	217	250	330	207	254	72	183	70
	6	150	356	533	350	410	225	280	410	235	280	356	225	279	78	216	80
	8	200	495	620	450	500	268	330	500	273	330	495	268	343	96	243	80
	10	250	—	—	—	620	315	400	—	—	—	622	315	406	109	290	90
	12	300	—	—	—	700	356	445	—	—	—	—	—	—	145	315	90
	14	350	—	—	—	—	—	—	—	—	—	—	—	—	184	330	90
	16	400	—	—	—	—	—	—	—	—	—	—	—	—	191	355	90
	18	450	—	—	—	—	—	—	—	—	—	—	—	—	204	388	90
20	500	—	—	—	—	—	—	—	—	—	—	—	—	—	—	—	
24	600	—	—	—	—	—	—	—	—	—	—	—	—	—	—	—	
BODY		Cast Iron			Cast Iron			Cast Iron			Cast Iron			Cast Iron+NBR			
BONNET		Cast Iron			—			—			—			—			
COVER		—			Cast Iron			Cast Iron			Cast Iron			—			
STEM		SUS403			—			—			—			—			
HINGE PIN		—			Forged Brass			Forged Brass			Forged Brass			SUS304			
DISC		Cast Bronze			Cast Bronze			Cast Bronze			Cast Bronze			Cast Bronze			

TYPE		WAFER CHECK			WAFER CHECK			WAFER CHECK			WAFER CHECK				
Cast Iron															
FIG		125FWNB			125FWNBE			PN16FWNB			PN16FWNBME				
PRESSURE		Class 125			125FWNBE			PN16			PN16				
END CONNECTION		Wafer Type			Wafer Type			Wafer Type			Wafer Type				
DIMENSIONS		inch	mm	L	H	D	L	H	D	L	H	D	L	H	D
Cast Iron	1 1/2	40	—	—	—	—	—	—	—	—	—	—	—	—	—
	2	50	54	—	105	54	—	105	—	—	—	—	—	—	—
	2 1/2	65	54	—	124	54	—	124	—	—	—	—	—	—	—
	3	80	57	—	137	57	—	137	—	—	—	—	—	—	—
	4	100	64	—	175	64	—	175	—	—	—	—	—	—	—
	5	125	70	—	197	70	—	197	—	—	—	—	—	—	—
	6	150	76	—	222	76	—	222	—	—	—	—	—	—	—
	8	200	95	—	279	95	—	279	—	—	—	—	—	—	—
	10	250	108	—	340	108	—	340	—	—	—	—	—	—	—
	12	300	143	—	410	143	—	410	—	—	—	—	—	—	—
	14	350	—	—	—	—	—	—	184	—	446	184	—	446	—
	16	400	—	—	—	—	—	—	191	—	498	191	—	498	—
	18	450	—	—	—	—	—	—	203	—	558	203	—	558	—
20	500	—	—	—	—	—	—	213	—	620	213	—	620	—	
24	600	—	—	—	—	—	—	222	—	737	222	—	737	—	
BODY		Cast Iron			Cast Iron			Cast Iron			Cast Iron				
BONNET		—			—			—			—				
HINGE PIN		Stainless Steel			Stainless Steel			TYPE 304			TYPE 304				
DISC		Bronze			Bronze			CF8M			CF8M				
SEAT		NBR			EPDM			NBR			EPDM				

Bronze & Brass  
 Cast Iron  
 Ductile Iron  
 Stainless Steel  
 Carbon Steel  
 Battery Valve  
 Ball Valve  
 Ball Valve Seat  
 Actuated Valve

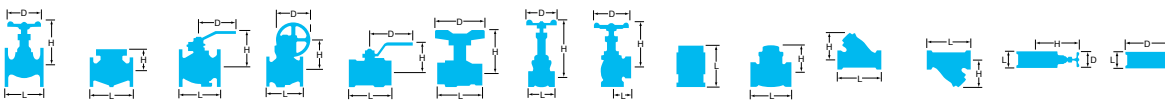

TYPE			Y TYPE STRAINER				Y TYPE STRAINER		
Cast Iron									
FIG			10FCY				125FCY		
PRESSURE			10K				Class 125		
END CONNECTION			JIS B2220				ASME B16.1		
DIMENSIONS	inch	mm	L	H	D	L	H	D	
	3/8	10	115	46	-	-	-	-	
	1/2	15	125	57	-	-	-	-	
	3/4	20	140	63	-	-	-	-	
	1	25	150	77	-	-	-	-	
	1 1/4	32	170	90	-	-	-	-	
	1 1/2	40	190	100	-	-	-	-	
	2	50	230	127	-	250	168	-	
	2 1/2	65	305	208	-	285	212	-	
	3	80	360	237	-	315	242	-	
	4	100	415	280	-	370	284	-	
	5	125	465	325	-	420	325	-	
	6	150	515	370	-	490	370	-	
	8	200	580	457	-	570	440	-	
	10	250	680	536	-	680	515	-	
	12	300	800	625	-	800	600	-	
	14	350	950	741	-	950	740	-	
BODY			Cast Iron				Cast Iron		
COVER			Cast Iron				Cast Iron		
STEM			-				-		
DISC			-				-		
SCREEN			SUS304				SUS304		

# DUCTILE IRON

## What is Ductile Iron ?

Gray iron, ductile iron and malleable iron are the three kinds of iron used for valve construction. Unlike gray iron, which has thin, flake-like molecular formations, the metallic structures of both ductile and malleable iron contain nodular graphite. (Refer to the microscopic views shown here.) This structure provides ductile and malleable iron with mechanical properties which exceed those of gray iron. It almost equals the properties of cast steel, which is an expensive material for industrial valves. Furthermore, their superior castability and machinability help to increase their suitability as a valve material.

Ductile iron outperforms malleable iron due to its better mechanical characteristics to build valve body, which is a kind of pressure containing device. For example, it has a 20% higher tensile strength and 70 to 80% better elongation. This difference comes from different formation process of nodulated graphite molecules.

KITZ ductile iron valves are made of JIS FCD-S or ASTM A395 ductile iron. The history of the introduction of ductile iron valves on the market is rather short, however, the demand is steadily increasing as a result of their economic advantage as well as the fact that their wide range of service applications is comparable with cast steel valves.

This catalog serves to provide design specifications, materials of construction and external dimensions of the following ductile iron valves and strainers manufactured by KITZ Corporation :

- JIS 10K, 16K & 20K Gate, Globe & Check Valves
- JIS 10K & 20K Ball Valves
- JIS 10K, 16K & 20K Strainers
- ASME 150 & 300 Gate, Globe & Check Valves

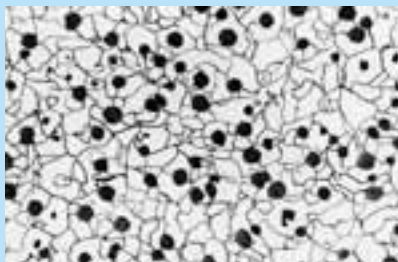

Ductile iron

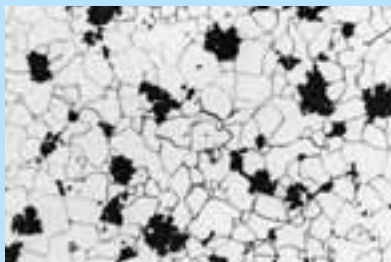

Malleable iron



Gray iron

### Service Recommendation

For higher mechanical shock resistance under high or low temperature, and better tensile strength and elongation characteristics than those of ordinary gray iron valves, ductile iron valves are highly re-commended for the following services, sometimes, in place of cast

- Piping for steam supply
- Air conditioning and heating systems
- High pressure gaseous service in general
- Piping for poisonous gas service

The range of high pressure gaseous service for iron valves is specified by Ministry of Economy, Trade and Industry of Japan as follows :

Valve material	Poisonous gas*	Inflammable gas	Other gas
Ductile iron (JIS FCD-S)		2.4MPa maximum -5°C to + 350°C	
Ductile iron (JIS FCD400)	not recommended	1.6MPa maximum 0°C to + 250°C	
Gray iron (JIS FC200)	not recommended		0.2MPa max. 0°C to + 250°C

\*Phosgene and hydrogen cyanide are excluded.

## Material Specifications of JIS FCD-S

### 1. Chemical composites :

Carbon : 3.00% minimum  
 Phosphor : 0.08% maximum  
 Silicon : 2.50% maximum however, 0.08% may be added for every decrease of 0.01% phosphor within the total maximum of 2.75%

### 2. Mechanical properties :

Tensile strength : 412N/mm<sup>2</sup>(42kgf/mm<sup>2</sup>) minimum  
 Yield strength : 275N/mm<sup>2</sup>(28kgf/mm<sup>2</sup>) minimum  
 Elongation : 18% minimum  
 Brinell haedness : 143 to 187

Charpy impact value:

- for ambient temperature service ;  
 17N·m/cm<sup>2</sup>(1.7kgf·m/cm<sup>2</sup>) minimum in average of 3 test pieces.  
 15N·m/cm<sup>2</sup>(1.5kgf·m/cm<sup>2</sup>) minimum for the lowest impact value.
- for -10°C or lower temperature service ;  
 15.3N·m/cm<sup>2</sup>(1.53kgf·m/cm<sup>2</sup>) minimum in average of 3 test pieces.  
 13.3N·m/cm<sup>2</sup>(1.33kgf·m/cm<sup>2</sup>) minimum for the lowest impact value.

## Compared Mechanical Properties of JIS Materials

### Tensile strength

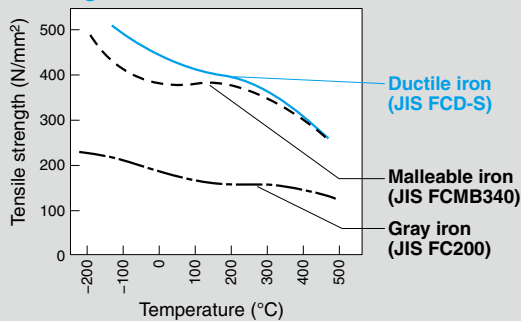

### Elongation

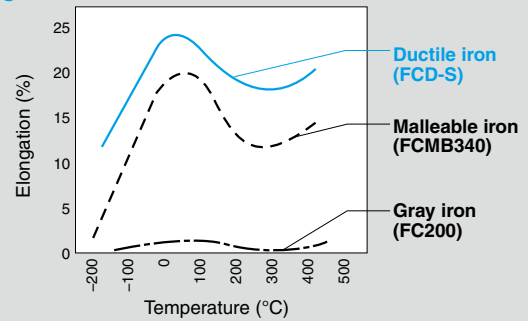

### Charpy impact value

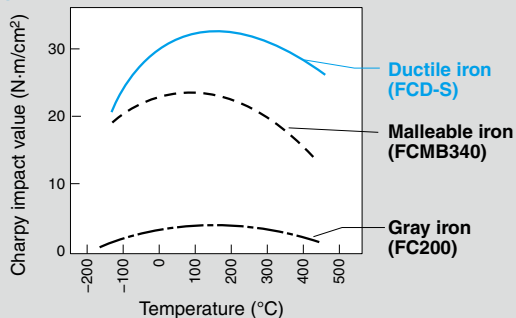

### Yield strength

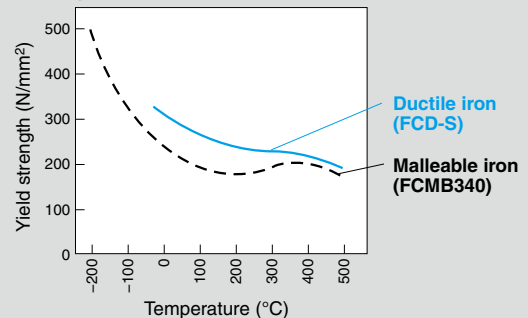

## Design Specifications (Please refer to our website ([www.kitz.co.jp](http://www.kitz.co.jp)) or contact KITZ for details.)

Class	JIS 10K/16K/20K	ASME 150/300
Face-to-face dimension	JIS B 2011, B 2002 or KITZ Std.	ASME B16. 10
End-to-end dimension	JIS B 2051 or KITZ Std.	—
End flange dimension	JIS B 2239	ASME B16. 5
End thread dimension	JIS B 0203	—
Shell wall thickness	KITZ standard, unless otherwise indicated on the following pages	

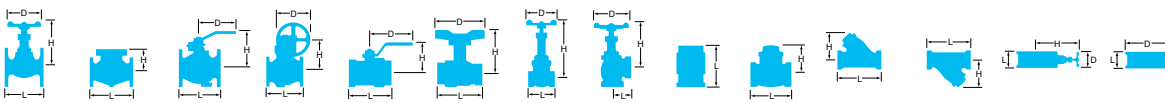

TYPE		GATE			GATE			GATE			GATE			GATE			
Ductile Iron																	
FIG		10SMS			10SMBF			10SMBOF			16SMB			16SMBO			
PRESSURE		10K			10K			10K			16K			16K			
END CONNECTION		BS21 (JIS B0203)			JIS B2239			JIS B2239			JIS B2239			JIS B2239			
DIMENSIONS	inch	mm	L	H	D	L	H	D	L	H	D	L	H	D	L	H	D
	1/2	15	60	150	60	90	164	70	—	—	—	108	163	70	—	—	—
	3/4	20	70	171	70	100	165	70	—	—	—	117	164	70	—	—	—
	1	25	75	198	80	110	188	80	—	—	—	127	187	80	—	—	—
	1 1/4	32	85	233	90	120	219	90	—	—	—	140	219	90	—	—	—
	1 1/2	40	95	274	100	130	253	100	165	300	160	165	253	100	165	300	160
	2	50	105	318	115	140	285	115	178	352	200	178	285	115	178	352	200
	2 1/2	65	—	—	—	—	—	—	190	410	200	—	—	—	190	410	200
	3	80	—	—	—	—	—	—	203	479	250	—	—	—	203	479	250
	4	100	—	—	—	—	—	—	229	566	250	—	—	—	229	566	250
	5	125	—	—	—	—	—	—	254	667	300	—	—	—	254	667	300
	6	150	—	—	—	—	—	—	267	779	300	—	—	—	267	779	300
	8	200	—	—	—	—	—	—	292	969	350	—	—	—	292	969	350
	10	250	—	—	—	—	—	—	330	1181	400	—	—	—	330	1181	400
	12	300	—	—	—	—	—	—	356	1404	450	—	—	—	356	1404	450
BODY		Ductile Iron			Ductile Iron			Ductile Iron			Ductile Iron			Ductile Iron			
BONNET		Ductile Iron			Ductile Iron			Ductile Iron			Ductile Iron			Ductile Iron			
STEM		SUS420J2			SUS420J2			SUS403			SUS420J2			SUS403			
DISC		SCS1			SCS1			SUS403 / SCS1			SCS1			SUS403 / SCS1			

TYPE		GATE			GATE			GATE			GLOBE			GLOBE			
Ductile Iron																	
FIG		16SMS			20SLS			150SMBO			10SJ			10SJBF			
PRESSURE		16K			20K			Class 150			10K			10K			
END CONNECTION		BS21 (JIS B0203)			BS21 (JIS B0203)			ASME B16.1			BS21 (JIS B0203)			JIS B2239			
DIMENSIONS	inch	mm	L	H	D	L	H	D	L	H	D	L	H	D	L	H	D
	1/4	8	—	—	—	—	—	—	—	—	—	50	108	60	—	—	—
	3/8	10	—	—	—	—	—	—	—	—	—	55	108	60	85	108	60
	1/2	15	65	163	70	70	175	90	—	—	—	65	122	70	85	122	70
	3/4	20	75	182	80	75	177	90	—	—	—	80	125	80	95	125	80
	1	25	80	212	90	85	214	100	—	—	—	90	146	90	110	146	90
	1 1/4	32	90	245	100	95	241	115	—	—	—	105	160	100	130	160	100
	1 1/2	40	100	285	115	105	277	135	165	300	160	120	180	115	150	180	115
	2	50	110	330	135	115	301	135	178	352	200	140	198	135	180	198	135
	2 1/2	65	—	—	—	—	—	—	190	408	200	180	250	180	210	250	180
	3	80	—	—	—	—	—	—	203	473	250	200	280	225	240	280	225
	4	100	—	—	—	—	—	—	229	566	250	—	—	—	—	—	—
	5	125	—	—	—	—	—	—	254	667	300	—	—	—	—	—	—
	6	150	—	—	—	—	—	—	267	779	300	—	—	—	—	—	—
	8	200	—	—	—	—	—	—	292	969	350	—	—	—	—	—	—
	10	250	—	—	—	—	—	—	330	1181	400	—	—	—	—	—	—
	12	300	—	—	—	—	—	—	356	1404	450	—	—	—	—	—	—
BODY		Ductile Iron			Ductile Iron			Ductile Iron			Ductile Iron			Ductile Iron			
BONNET		Ductile Iron			Ductile Iron			Ductile Iron			Ductile Iron			Ductile Iron			
STEM		SUS420J2			SUS420J2			SUS403			SUS420J2			SUS420J2			
DISC		SCS1			SCS1			SUS403 / SCS1			SUS403			SUS403			

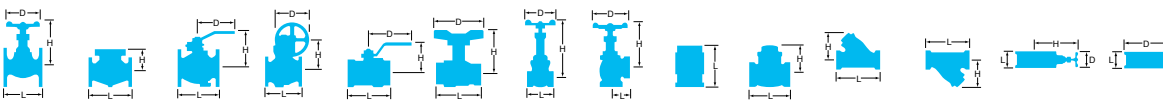

TYPE		GLOBE			GLOBE			GLOBE			GLOBE			GLOBE			
Ductile Iron																	
FIG		10SP			10SPBF			10SPBOF			10SPD			10SPDBF			
PRESSURE		10K			10K			10K			10K			10K			
END CONNECTION		BS21 (JIS B0203)			JIS B2239			JIS B2239			BS21 (JIS B0203)			JIS B2239			
DIMENSIONS	inch	mm	L	H	D	L	H	D	L	H	D	L	H	D	L	H	D
	3/8	10	64	107	60	108	107	60	-	-	-	-	-	-	-	-	-
	1/2	15	70	125	80	108	125	80	-	-	-	70	125	80	108	125	80
	3/4	20	80	125	80	117	125	80	-	-	-	80	125	80	117	125	80
	1	25	90	145	100	127	145	100	-	-	-	90	146	100	127	145	100
	1 1/4	32	110	162	115	140	162	115	-	-	-	110	162	115	140	162	115
	1 1/2	40	120	180	115	165	180	115	-	-	-	120	180	115	165	180	115
	2	50	140	198	135	203	198	135	203	302	200	140	198	135	203	198	135
	2 1/2	65	-	-	-	-	-	-	216	317	225	-	-	-	-	-	-
	3	80	-	-	-	-	-	-	241	356	250	-	-	-	-	-	-
	4	100	-	-	-	-	-	-	292	377	250	-	-	-	-	-	-
	5	125	-	-	-	-	-	-	356	460	300	-	-	-	-	-	-
	6	150	-	-	-	-	-	-	406	524	350	-	-	-	-	-	-
	8	200	-	-	-	-	-	-	495	585	400	-	-	-	-	-	-
BODY		Ductile Iron			Ductile Iron			Ductile Iron			Ductile Iron			Ductile Iron			
#ONNET		Ductile Iron			Ductile Iron			Ductile Iron			Ductile Iron			Ductile Iron			
STEM		SUS420J2			SUS420J2			SUS420J2			SUS420J2			SUS420J2			
#DISC		SUS403			SUS403			SUS403			G/F PTFE			G/F PTFE			
											Soft Seated disc			Soft Seated disc			

TYPE		GLOBE			GLOBE			GLOBE			GLOBE			GLOBE			
Ductile Iron																	
FIG		10SPDBF			10SD			10SDBF			10SDL			10SDLBF			
PRESSURE		10K			10K			10K			10K			10K			
END CONNECTION		JIS B2239			BS21 (JIS B0203)			JIS B2239			BS21 (JIS B0203)			JIS B2239			
DIMENSIONS	inch	mm	L	H	D	L	H	D	L	H	D	L	H	D	L	H	D
	1/4	8	-	-	-	50	108	60	-	-	-	-	-	-	-	-	-
	3/8	10	-	-	-	55	108	60	85	108	60	55	112	55	85	112	55
	1/2	15	-	-	-	65	123	70	85	123	70	65	122	60	85	122	60
	3/4	20	-	-	-	80	123	80	95	123	80	80	130	70	95	130	70
	1	25	-	-	-	90	144	90	110	144	90	90	149	80	110	149	80
	1 1/4	32	-	-	-	105	159	100	130	159	100	105	169	90	130	169	90
	1 1/2	40	-	-	-	120	178	115	150	178	115	120	187	100	150	187	100
	2	50	203	302	200	140	197	135	180	197	135	140	205	115	180	205	115
	2 1/2	65	216	317	225	180	262	180	210	262	180	-	-	-	-	-	-
	3	80	241	356	250	200	295	225	240	295	225	-	-	-	-	-	-
	4	100	292	377	250	-	-	-	-	-	-	-	-	-	-	-	-
	5	125	356	460	300	-	-	-	-	-	-	-	-	-	-	-	-
	6	150	406	527	350	-	-	-	-	-	-	-	-	-	-	-	-
	8	200	495	600	400	-	-	-	-	-	-	-	-	-	-	-	-
BODY		Ductile Iron			Ductile Iron			Ductile Iron			Ductile Iron			Ductile Iron			
#ONNET		Ductile Iron			Ductile Iron			Ductile Iron			Ductile Iron			Ductile Iron			
STEM		SUS403			SUS420J2			SUS420J2			SUS420J2			SUS420J2			
#DISC		G/F PTFE			G/F PTFE			G/F PTFE			G/F PTFE			G/F PTFE			
		Soft Seated disc			Soft Seated disc			Soft Seated disc			Soft Seated disc			Soft Seated disc			

Bronze & Brass  
 Cast Iron  
 Ductile Iron  
 Stainless Steel  
 Carbon Steel  
 Buttery Valve  
 Ball Valve  
 Ball Valve Seat  
 Actuated Valve

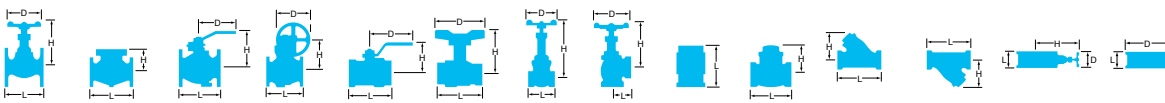

TYPE		GLOBE			GLOBE			GLOBE			GLOBE			GLOBE			
Ductile Iron																	
FIG		16SP			16SPB			16SPBO			20SY			20SYB			
PRESSURE		16K			16K			16K			20K			20K			
END CONNECTION		BS21 (JIS B0203)			JIS B2239			JIS B2239			BS21 (JIS B0203)			JIS B2239			
DIMENSIONS	inch	mm	L	H	D	L	H	D	L	H	D	L	H	D	L	H	D
	3/8	10	64	110	60	108	111	60	—	—	—	75	136	70	110	136	70
	1/2	15	70	122	80	108	122	80	—	—	—	78	138	80	110	138	80
	3/4	20	85	128	80	117	128	80	—	—	—	91	157	100	120	157	100
	1	25	95	147	100	127	146	100	—	—	—	105	178	115	130	178	115
	1 1/4	32	110	165	115	140	165	115	—	—	—	122	202	135	160	202	135
	1 1/2	40	125	182	115	165	182	115	—	—	—	135	210	135	180	210	135
	2	50	145	196	135	203	198	135	203	302	200	160	239	180	230	239	180
	2 1/2	65	—	—	—	—	—	—	216	313	225	—	—	—	—	—	—
	3	80	—	—	—	—	—	—	241	356	250	—	—	—	—	—	—
	4	100	—	—	—	—	—	—	292	377	250	—	—	—	—	—	—
	5	125	—	—	—	—	—	—	356	460	300	—	—	—	—	—	—
	6	150	—	—	—	—	—	—	406	524	350	—	—	—	—	—	—
	8	200	—	—	—	—	—	—	495	585	400	—	—	—	—	—	—
BODY		Ductile Iron			Ductile Iron			Ductile Iron			Ductile Iron			Ductile Iron			
BONNET		Ductile Iron			Ductile Iron			Ductile Iron			Ductile Iron			Ductile Iron			
STEM		SUS420J2			SUS420J2			SUS403			SUS420J2			SUS420J2			
DISC		SUS403			SUS403			SUS403			SUS403+HF			SUS403+HF			

TYPE		GLOBE			GLOBE			LIFT CHECK			LIFT CHECK			LIFT CHECK			
Ductile Iron																	
FIG		150SPB			150SPDB			10SF			10SFBF			10SN			
PRESSURE		Class 150			Class 150			10K			10K			10K			
END CONNECTION		ASME B16.1			ASME B16.1			BS21 (JIS B0203)			JIS B2239			BS21 (JIS B0203)			
DIMENSIONS	inch	mm	L	H	D	L	H	D	L	H	D	L	H	D	L	H	D
	3/8	10	—	—	—	—	—	—	—	—	—	—	—	—	—	—	—
	1/2	15	108	122	80	108	127	70	65	39	28	85	39	95	70	50	30
	3/4	20	117	128	80	117	135	70	80	42	34	95	42	100	80	53	36
	1	25	127	146	100	127	155	90	90	48	42	110	48	125	90	61	45
	1 1/4	32	140	165	115	140	172	100	105	56	52	130	56	135	110	69	55
	1 1/2	40	165	179	115	165	193	115	120	65	58	150	65	140	120	75	60
	2	50	203	198	135	203	208	135	140	73	72	180	73	155	140	87	78
	2 1/2	65	—	—	—	—	—	—	—	—	—	—	—	—	—	—	—
	3	80	—	—	—	—	—	—	—	—	—	—	—	—	—	—	—
	4	100	—	—	—	—	—	—	—	—	—	—	—	—	—	—	—
	5	125	—	—	—	—	—	—	—	—	—	—	—	—	—	—	—
	6	150	—	—	—	—	—	—	—	—	—	—	—	—	—	—	—
	8	200	—	—	—	—	—	—	—	—	—	—	—	—	—	—	—
BODY		Ductile Iron			Ductile Iron			Ductile Iron			Ductile Iron			Ductile Iron			
BONNET		Ductile Iron			Ductile Iron			—			—			CF8 / TYPE304			
CAP		—			—			TYPE 403 / SCS1			TYPE 403 / SCS1			—			
STEM		SUS420J2			SUS420J2			—			—			—			
DISC		SUS403			G/F PTFE			SUS403			SUS403			SUS403 / SCS1			
					Soft Seated disc												



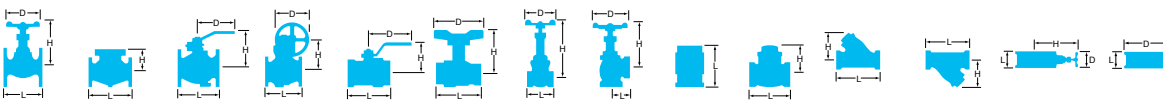

TYPE	LIFT CHECK					LIFT CHECK			LIFT CHECK			LIFT CHECK			SWING CHECK		
Ductile Iron																	
FIG	10SNBF					16SF			16SFB			20SN			10SRBF		
PRESSURE	10K					16K			16K			20K			10K		
END CONNECTION	JIS B2239					BS21 (JIS B0203)			JIS B2239			BS21 (JIS B0203)			JIS B2239		
DIMENSIONS	inch	mm	L	H	D	L	H	D	L	H	D	L	H	D	L	H	D
	1/2	15	108	50	95	70	50	30	108	50	95	78	56	32	—	—	—
	3/4	20	117	53	100	85	53	36	117	53	100	91	60	38	—	—	—
	1	25	127	61	125	95	61	45	127	61	125	105	68	47	—	—	—
	1 1/4	32	140	69	135	110	69	55	140	69	135	122	80	57	—	—	—
	1 1/2	40	165	75	140	125	75	60	165	75	140	135	85	62	165	115	140
	2	50	203	87	155	145	87	78	203	87	155	160	99	79	203	120	155
	2 1/2	65	—	—	—	—	—	—	—	—	—	—	—	—	216	130	175
	3	80	—	—	—	—	—	—	—	—	—	—	—	—	241	145	185
	4	100	—	—	—	—	—	—	—	—	—	—	—	—	292	160	210
	5	125	—	—	—	—	—	—	—	—	—	—	—	—	330	195	250
	6	150	—	—	—	—	—	—	—	—	—	—	—	—	356	215	280
	8	200	—	—	—	—	—	—	—	—	—	—	—	—	495	255	330
	10	250	—	—	—	—	—	—	—	—	—	—	—	—	622	310	400
	12	300	—	—	—	—	—	—	—	—	—	—	—	—	698	350	445
BODY	Ductile Iron					Ductile Iron			Ductile Iron			Ductile Iron			Ductile Iron		
BONNET	CF8 / TYPE304					CF8 / TYPE304			CF8 / TYPE304			TYPE 403 / SCS1			Ductile Iron		
COVER	—					—			—			—			Ductile Iron		
HINGE PIN	—					—			—			—			SUS403		
DISC	SUS403 / SCS1					SUS403 / SCS1			SUS403 / SCS1			SCS13A+HF			SUS403		
SEAT	—					—			—			Stainless Steel+HF			—		

TYPE	SWING CHECK					SWING CHECK			SWING CHECK		
Ductile Iron											
FIG	16SRB					20SOB			150SRB		
PRESSURE	16K					20K			Class 150		
END CONNECTION	JIS B2239					JIS B2239			ASME B16.1		
DIMENSIONS	inch	mm	L	H	D	L	H	D	L	H	D
	1 1/2	40	—	—	—	—	—	—	165	115	127
	2	50	203	120	155	267	135	155	203	120	152
	2 1/2	65	216	135	175	292	145	175	216	130	178
	3	80	241	145	200	318	160	200	241	145	190
	4	100	292	165	225	356	185	225	292	165	229
	5	125	330	200	270	400	220	270	330	200	254
	6	150	356	220	305	444	240	305	356	220	279
	8	200	495	265	350	533	275	350	495	260	343
	10	250	622	320	430	622	335	430	622	320	406
	12	300	698	360	480	711	370	480	698	360	483
	14	350	—	—	—	—	—	—	—	—	—
	16	400	—	—	—	—	—	—	—	—	—
	18	450	—	—	—	—	—	—	—	—	—
BODY	Ductile Iron					Ductile Iron			Ductile Iron		
COVER	Ductile Iron					Ductile Iron			Ductile Iron		
HINGE PIN	SUS403					SUS403			SUS403		
DISC	SUS403					SUS403			SUS403		

Brass & Bronze

Cast Iron

Ductile Iron

Stainless Steel

Carbon Steel

Battery Valve

Ball Valve

Ball Valve Seat

Actuated Valve

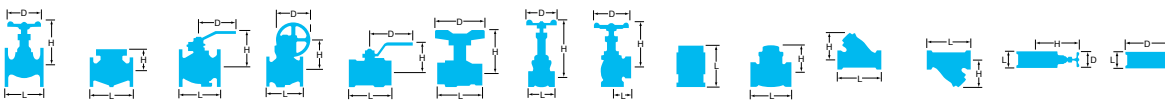

TYPE		WAFER CHECK				WAFER CHECK			WAFER CHECK		
Ductile Iron											
FIG		10SWZU				20SWZ			20SWZU		
PRESSURE		10K				20K			20K		
END CONNECTION		Wafer Type				Wafer Type			Wafer Type		
DIMENSIONS	inch	mm	L	H	D	L	H	D	L	H	D
	1 1/2	40	—	—	—	54	128	55	—	—	—
	2	50	56	161	70	56	133	60	56	146	60
	2 1/2	65	56	168	70	60	150	70	60	168	70
	3	80	59	174	70	67	156	70	67	174	70
	4	100	66	187	70	68	169	70	68	187	70
	5	125	72	201	70	83	183	70	83	201	70
	6	150	78	220	80	95	216	80	95	219	80
	8	200	96	247	80	127	243	80	127	246	90
	10	250	109	298	90	140	290	90	140	293	90
	12	300	145	324	90	181	315	90	181	318	90
	14	350	184	337	90	184	330	90	184	337	90
	16	400	191	365	90	191	355	90	191	365	90
	18	450	204	394	90	204	388	90	204	394	90
BODY		Ductile Iron+NBR				Ductile Iron+NBR			Ductile Iron+NBR		
BONNET		—				—			—		
HINGE PIN		SUS304				SUS304			SUS304		
DISC		SCS13				Cast Bronze			SCS13		

TYPE		Y TYPE STRAINER			Y TYPE STRAINER			Y TYPE STRAINER			Y TYPE STRAINER			Y TYPE STRAINER			
Ductile Iron																	
FIG		10FDY			10FDYBF			16FDY			16FDYB			20FDY			
PRESSURE		10K			10K			16K			16K			20K			
END CONNECTION		BS21 (JIS B0203)			JIS B2239			BS21 (JIS B0203)			JIS 2239			BS21 (JIS B0203)			
DIMENSIONS	inch	mm	L	H	D	L	H	D	L	H	D	L	H	D	L	H	D
	1/4	8	65	46	21	—	—	—	—	—	—	—	—	—	—	—	—
	3/8	10	70	46	23	—	—	—	—	—	—	—	—	—	80	65	27
	1/2	15	85	60	30	125	57	95	85	60	32	125	57	95	85	65	32
	3/4	20	100	65	36	140	63	100	100	65	38	140	63	100	100	70	38
	1	25	115	75	45	150	77	125	115	75	47	150	77	125	115	83	47
	1 1/4	32	135	90	55	170	90	135	135	90	57	170	90	135	135	120	57
	1 1/2	40	150	100	60	190	100	140	150	100	62	190	100	140	150	130	62
	2	50	180	115	78	230	138	155	180	115	79	250	158	155	180	152	79
	2 1/2	65	220	191	90	305	212	175	—	—	—	305	212	175	—	—	—
	3	80	250	215	105	360	242	185	—	—	—	360	242	200	—	—	—
	4	100	—	—	—	415	284	210	—	—	—	415	284	225	—	—	—
	5	125	—	—	—	465	325	250	—	—	—	465	325	270	—	—	—
	6	150	—	—	—	515	370	280	—	—	—	515	370	305	—	—	—
	8	200	—	—	—	580	462	330	—	—	—	580	462	350	—	—	—
	10	250	—	—	—	680	536	400	—	—	—	680	536	430	—	—	—
	12	300	—	—	—	800	625	445	—	—	—	800	625	480	—	—	—
BODY		Ductile Iron			Ductile Iron			Ductile Iron			Ductile Iron			Ductile Iron			
CAP		Ductile Iron			—			Brass			—			Ductile Iron			
COVER		—			Ductile Iron			—			Ductile Iron			Ductile Iron			
DISC		—			—			—			—			—			
SCREEN		SUS304			SUS304			SUS304			SUS304			SUS304			

# STAINLESS STEEL

# Stainless Steel

## General Design Specifications

Series	Normal pressure	Pressure - temperature ratings*	Face-to face dimensions	End connection dimensions	Wall thickness
A	10K	JIS B2220	JIS B2002	JIS B2220 10K flanged	ASME B16.34
	20K			JIS B2220 20K flanged	
	Class 150/300/600			ASME B16.5 flanged	
HA	Class 150/300	ASME B16.34	ASME B16.10	ASME B16.5 flanged	API 603
C	Class 150/300/600/900/1500	ASME B16.34	ASME B16.10	ASME B16.5 flanged	API 600
B	5K	0.5MPa 150°C	JIS B 2011 KITZ Std.	JIS B0203 threaded	JIS B 2011 KITZ Std.
	10K	1.0MPa 180°C		JIS B2220 5K 10K flanged	
	20K	2.0MPa 180°C		ASME B1.20.1 threaded	
	Type 200	KITZ Std.			
D	Class 150/300/600	ASME B16.34	KITZ Std.	ASME B1.20.1 threaded ASME B16.11 socket welded	ASME B16.34
AJ	10K	JIS B2220	KITZ Std.	JIS B2220 10K flanged	ASME B16.34
	20K			JIS B2220 20K flanged	
	Class 150/300			ASME B16.5 flanged	

\*Actual pressure-temperature rating in service depends on the materials of gland packing and gasket chosen for valves.

## Bonnet Gasket Materials

Depending on class ratings and servicing conditions, following gasket materials are available\* for body/bonnet flange gaskets of KITZ stainless and high alloy steel valves. Specify your gasket material in your purchase order.

Series	Series C			Series A·HA·D·AJ		
	Class 150	Class 300	Class 600/900/1500	10K, Class 150	20k, Class 300	Class 600
Gasket material						
Corrugated metal	●					
Ring joint metal			●			
Spiral wound metal, PTFE filled		●			●	●
Flexible graphite	●			●	●	
Spiral wound metal, flexible graphite filled		●			●	●
Stainless steel inserted flexible graphite	●			●	●	
Ceramic filled PTFE	●			●	●	

Please refer to our website ([www.kitz.co.jp](http://www.kitz.co.jp)) or contact KITZ for details. \*Except Series B valves which employ only KITZ standard materials.

## Gland Packing Materials



Following packing materials can be chosen for KITZ stainless and high alloy steel valves, depending on service conditions, or market requirements. Specify your packing material in your purchase order.

Asbestos-free	Packing material	Service conditions
	Braided PTFE fiber	260°C (500°F) corrosion resistant
PTFE cup & cone / PTFE V-ring	150°C (300°F) corrosion resistant	
Carbon fiber	500°C (930°F) high pressure	
Flexible graphite	600°C (1110°F)* corrosion resistant	
Inconel wired flexible graphite	600°C (1110°F)* corrosion resistant	

Please refer to our website ([www.kitz.co.jp](http://www.kitz.co.jp)) or contact KITZ for details. \*455°C(850°F) for oxidizing atmosphere.

Contact KITZ Corporation or your KITZ distributors for optional requirement of gasket or gland packing materials other than listed above.

## General Design Specifications

Series	Nominal Pressure	Solid wedge 	Flexible wedge 
<b>A</b>	10K, 20K, Class 150, 300, 600	—	All sizes
<b>HA</b>	Class 150, 300	—	All sizes
<b>C</b>	Class 150, 300	4 & smaller	6 & larger
	Class 600, 900, 1500	1 1/2 & smaller	2 & larger
<b>B</b>	5K, 10K, 20K, 200	All sizes	—
<b>D</b>	Class 150, 300, 600	—	All sizes
<b>AJ</b>	10K, 20K, Class 150, 300	—	All sizes

## Pressure-Temperature Ratings for Series B (KITZ Standard)

Temperature	W	G1	G2
	120°C below	150°C below	180°C below
5K	0.7	0.5	—
10K	1.4	1.1	1.0
20K	2.0	1.2	1.0

MPa

W: Static water without pressure variation

G1, G2: Steam, air, non-inflammable gas and oil (lubricant and machining oil)

Note: Actual pressure-temperature rating in service depends on the materials of gland packing and gasket chosen for valves.

### Product Coding (Except for Series B)

**AK-150 U M A M 4**



#### 1 End connection

None.. RF-Flanged with smooth finished gasket face

AK..... Threaded Ends to ASME B1.20.1 NPT

AW..... Socket Welding Ends to ASME B16.11

#### 2 Nominal Pressure

Code	Nominal Pressure	Code	Nominal Pressure
5	JIS 5K	300	ASME 300
10	JIS 10K	600	ASME 600
20	JIS 20K	900	ASME 900
150	ASME Class150	1500	ASME Class1500

#### 3 Product identification

U... Identification code for stainless and high alloy steel valves in general.

#### 4 Valve type

M... Gate valves  
P... Globe valves  
PD... Soft Seated Globe valves  
O... Swing Check valves  
N... Lift Check valves  
Y... Y-pattern Strainers

#### 5 Valve design

Code Series  
A..... Series A  
HA..... Series HA  
C..... Series C  
None.. Series D  
AJ..... Series A, Jacketed  
AW..... Series A, Bellows Seal

#### 6 Shell material

None.. CF8 (304)  
M..... CF8M (316)  
O..... CF3M (316L)  
V..... CF3 (304L)  
CB..... CF8C (321)  
CG..... CG8M (317)  
CK..... CK20 (310)  
SD..... Super Duplex Stainless Steel (SDPV-K1)  
CN..... CN7M (Alloy 20)  
HB..... N-12MV (Hastelloy B)  
HC..... CW-12MW (Hastelloy C)

#### 7 Nominal valve size

JIS flanged.. in mm base  
Others..... in inches base

## KITZ Low Emission Service Valves

In the United States, the Federal Clean Air Act was dramatically amended in 1990, to realize the new environmental protection policy of a 95% reduction in fugitive emission or leak levels of toxic gases and chemicals from plant equipment. Promulgated in April, 1994, the new law requires all plants handling the toxic gas specified by the Environmental Protection Agency, to periodically monitor their plant equipment for detection of leaks exceeding 500 ppm, and repair or replace all defective parts immediately. California has exceeded the Federal law with a state regulation requiring 100 ppm maximum leak level for an astonishing 99% reduction of such an environmental pollution for the Northern California Region after 1997.



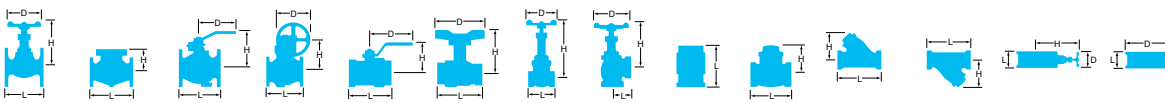

Our low emission valves, the proud fruits of several years of trial and error at our laboratory, are designed, engineered, manufactured and tested to now meet the 100 ppm maximum emission level. This is the standard specification in North America for KITZ Class 150, 300 and 600 Series A and C stainless and high alloy steel valves. In other markets, all these low emission valves are optionally available. Major design considerations for having upgraded our standard valves to the low emission performers are introduced below.



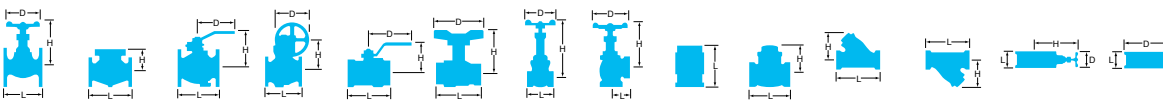



TYPE		B-SEREAS GATE			B-SEREAS GATE			B-SEREAS GATE			B-SEREAS GATE			B-SEREAS GATE			
Stainless Steel																	
FIG		UE			UEM			UEB			UEBM			UEL			
PRESSURE		10K			10K			10K			10K			10K			
END CONNECTION		BS21 (JIS B0203)			BS21 (JIS B0203)			JIS B2220			JIS B2220			BS21 (JIS B0203)			
DIMENSIONS	inch	mm	L	H	D	L	H	D	L	H	D	L	H	D	L	H	D
	1/2	15	-	-	-	-	-	-	85	99	70	-	-	-	54	96	70
	3/4	20	-	-	-	-	-	-	95	105	70	-	-	-	58	101	70
	1	25	-	-	-	-	-	-	100	116	80	100	116	80	65	112	80
	1 1/4	32	-	-	-	-	-	-	110	128	80	110	128	80	74	123	80
	1 1/2	40	-	-	-	-	-	-	125	170	100	125	170	100	78	150	100
	2	50	-	-	-	-	-	-	140	188	100	140	188	100	87	167	100
	2 1/2	65	115	248	135	115	248	135	170	248	135	170	248	135	-	-	-
	3	80	130	275	155	130	275	155	190	275	155	190	275	155	-	-	-
	4	100	155	315	200	155	315	200	-	-	-	-	-	-	-	-	-
BODY		SCS13A			SCS13A			SCS13A			SCS14A			SCS13A			
BONNET		SCS13A			SCS13A			SCS13A / SUS304			SCS14A / SUS316			SCS13A			
STEM		SUS304			SUS304			SUS304			SUS316			SUS304			
DISC		SCS13A			SCS13A			SCS13A			SCS14A			SCS13A			

TYPE		B-SEREAS GATE			B-SEREAS GATE			A-SEREAS GATE			A-SEREAS GATE			A-SEREAS GATE			
Stainless Steel																	
FIG		UELM			DKUELM			10UMA / 10UMAT			10UMAM / 10UMAMT			20UMA / 20UMAT			
PRESSURE		10K			PN16			10K			10K			20K			
END CONNECTION		BS21 (JIS B0203)			DIN 259			JIS B2220			JIS B2220			JIS B2220			
DIMENSIONS	inch	mm	L	H	D	L	H	D	L	H	D	L	H	D	L	H	D
	1/2	15	54	96	70	54	96	70	108	198	90	108	198	90	140	207	100
	3/4	20	58	101	70	58	101	70	117	208	90	117	208	90	152	217	100
	1	25	65	112	80	65	112	80	127	224	100	127	224	100	165	236	100
	1 1/4	32	74	123	80	74	123	80	140	238	100	140	238	100	190	292	140
	1 1/2	40	78	150	100	78	150	100	165	282	140	165	282	140	216	353	180
	2	50	87	167	100	87	167	100	178	336	160	178	336	160	241	404	180
	2 1/2	65	-	-	-	-	-	-	190	375	180	190	375	180	283	470	225
	3	80	-	-	-	-	-	-	203	445	200	203	445	200	305	560	250
	4	100	-	-	-	-	-	-	229	523	225	229	523	225	381	626	300
	5	125	-	-	-	-	-	-	254	606	250	254	606	250	403	753	350
	6	150	-	-	-	-	-	-	267	710	250	267	710	250	419	968	400
	8	200	-	-	-	-	-	-	292	920	300	292	920	300	457	1170	450
	10	250	-	-	-	-	-	-	330	1117	350	330	1117	350	502	1380	500
	12	300	-	-	-	-	-	-	356	1324	400	356	1324	400	762	1590	600
	14	350	-	-	-	-	-	-	381	1486	450	381	1486	450	838	1810	600
	16	400	-	-	-	-	-	-	406	1690	600	406	1690	600	914	1980	680
	18	450	-	-	-	-	-	-	432	1890	600	432	1890	600	991	2190	760
	20	500	-	-	-	-	-	-	457	2100	680	457	2100	680	1143	2580	910
	22	550	-	-	-	-	-	-	508	2460	760	508	2460	760	-	-	-
BODY		SCS14A			A351 Gr.CF8M			SCS13A			SCS14A			SCS13A			
BONNET		SCS14A			A351 Gr.CF8M			SCS13A			SCS14A			SCS13A			
STEM		SUS316			A276 TYPE316			SUS304			SUS316			SUS304			
DISC		SCS14A			A351 Gr.CF8M			SCS13A			SCS14A			SCS13A			
								Fig. 10UMAT : Gland Packing / PTFE			Fig. 10UMAMT : Gland Packing / PTFE			Fig. 20UMAT : Gland Packing / PTFE			



TYPE		A-SEREAS GATE				A-SEREAS GATE			A-SEREAS GATE			A-SEREAS GATE			A-SEREAS GATE			
Stainless Steel																		
FIG		20UMAM / 20UMAMT				150UMA / 150UMAT			150UMAM / 150UMAMT			300UMA			300UMAM			
PRESSURE		20K				Class 150			Class 150			Class 300			Class 300			
END CONNECTION		JIS B2220				ASME B16.5			ASME B16.5			ASME B16.5			ASME B16.5			
DIMENSIONS		inch	mm	L	H	D	L	H	D	L	H	D	L	H	D	L	H	D
		1/2	15	140	207	100	108	198	90	108	198	90	140	207	100	140	207	100
		3/4	20	152	217	100	117	208	90	117	208	90	152	217	100	152	217	100
		1	25	165	236	100	127	224	100	127	224	100	165	236	100	165	236	100
		1 1/2	40	190	292	140	165	282	140	165	282	140	190	292	140	190	292	140
		2	50	216	353	180	178	336	160	178	336	160	216	353	180	216	353	180
		2 1/2	65	241	404	180	190	375	180	190	375	180	241	404	180	241	404	180
		3	80	283	470	225	203	445	200	203	445	200	283	470	225	283	470	225
		4	100	305	560	250	229	523	225	229	523	225	305	560	250	305	560	250
		5	125	381	626	300	254	606	250	254	606	250	381	626	300	381	626	300
		6	150	403	753	350	267	710	250	267	710	250	403	753	350	403	753	350
		8	200	419	968	400	292	920	300	292	920	300	419	968	400	419	968	400
		10	250	457	1170	450	330	1117	350	330	1117	350	457	1170	450	457	1170	450
		12	300	502	1380	500	356	1324	400	356	1324	400	502	1380	500	502	1380	500
		14	350	762	1590	600	381	1486	450	381	1486	450	762	1590	600	762	1590	600
		16	400	838	1810	600	406	1690	600	406	1690	600	838	1810	600	838	1810	600
		18	450	914	1980	680	432	1890	600	432	1890	600	914	1980	680	914	1980	680
		20	500	991	2190	760	457	2100	680	457	2100	680	991	2190	760	991	2190	760
		24	600	1143	2580	910	508	2460	760	508	2460	760	1143	2580	910	1143	2580	910
BODY		SCS14A				A351 Gr.CF8			A351 Gr.CF8M			A351 Gr.CF8			A351 Gr.CF8M			
BONNET		SCS14A				A351 Gr.CF8			-			A351 Gr.CF8			A351 Gr.CF8M			
COVER		-				-			A351 Gr.CF8M			-			-			
STEM		SUS316				TYPE 304			TYPE 316			A276 TYPE 304			A276 TYPE 316			
DISC		SCS14A				A351 Gr.CF8			A351 Gr.CF8M			A351 Gr.CF8			A351 Gr.CF8M			
		Fig. 20UMAMT : Gland Packing / PTFE				Fig. 150UMAT : Gland Packing / PTFE			Fig. 150UMAMT : Gland Packing / PTFE									

TYPE		A-SEREAS GATE				A-SEREAS GATE			A-SEREAS GATE			A-SEREAS GATE			A-SEREAS GATE			
Stainless Steel																		
FIG		600UMA				600UMAM			10UMAJ			20UMAJ			150UMAJ			
PRESSURE		600LB				600LB			10K			20K			Class 150			
END CONNECTION		ASME B16.5				ASME B16.5			JIS B2220			JIS B2220			ASME B16.5			
DIMENSIONS		inch	mm	L	H	D	L	H	D	L	H	D	L	H	D	L	H	D
		1/2	15	165	207	100	165	207	100	169	199	100	173	199	100	165	199	100
		3/4	20	190	222	100	190	222	100	169	213	100	173	213	100	165	213	100
		1	25	216	250	140	216	250	140	177	232	100	181	232	100	177	232	100
		1 1/2	40	241	335	180	241	335	180	188	283	140	192	283	140	187	283	140
		2	50	292	450	200	292	450	200	201	322	160	270	353	180	203	322	160
		2 1/2	65	330	480	225	330	480	225	-	-	-	-	-	-	-	-	-
		3	80	356	544	250	356	544	250	217	447	200	289	470	225	229	447	200
		4	100	432	676	350	432	676	350	260	523	225	386	560	250	267	523	225
		5	125	-	-	-	-	-	-	-	-	-	-	-	-	-	-	-
		6	150	559	905	450	559	905	450	279	710	250	434	753	350	292	710	250
		8	200	660	1130	500	660	1130	500	-	-	-	-	-	-	-	-	-
		10	250	787	1328	600	787	1328	600	-	-	-	-	-	-	-	-	-
		12	300	838	1524	680	838	1524	680	-	-	-	-	-	-	-	-	-
BODY		A351 Gr.CF8				A351 Gr.CF8			SCS13A			SCS13A			A351 Gr.CF8			
BONNET		A351 Gr.CF8				A351 Gr.CF8			SCS13A			SCS13A			A351 Gr.CF8			
STEM		A276 TYPE 304 / A351 Gr.CF8				A276 TYPE 316 / A351 Gr.CF8M			SUS304			SUS304			TYPE 304			
DISC		A351 Gr.CF8				A351 Gr.CF8			SCS13A			SCS13A			A351 Gr.CF8			
									Full Jacketed			Full Jacketed			Full Jacketed			

Bronze & Brass  
 Cast Iron  
 Ductile Iron  
 Stainless Steel  
 Carbon Steel  
 Battery Valve  
 Ball Valve  
 Ball Valve Seat  
 Actuated Valve

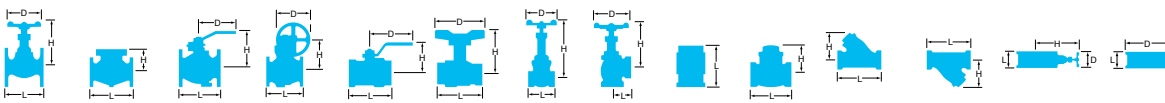





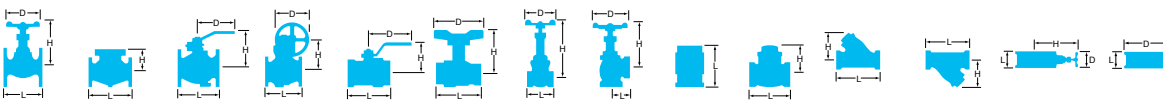

TYPE		A-SEREAS GATE			B-SEREAS GLOBE			B-SEREAS GLOBE			B-SEREAS GLOBE			B-SEREAS GLOBE			
Stainless Steel																	
FIG		300UMAJ			UAB			UCL			UCB			UD			
PRESSURE		Class 300			5K			10K			10K			10K			
END CONNECTION		ASME B16.5			JIS B2220			BS21 (JIS B0203)			JIS B2220			BS21 (JIS B0203)			
DIMENSIONS	inch	mm	L	H	D	L	H	D	L	H	D	L	H	D	L	H	D
	1/4	8	—	—	—	—	—	—	44	68	55	—	—	—	—	—	—
	3/8	10	—	—	—	73	106	70	48	68	55	73	106	70	55	109	60
	1/2	15	178	199	100	85	106	70	52	68	55	85	106	70	65	112	60
	3/4	20	178	213	100	95	108	70	60	93	60	95	108	70	80	113	70
	1	25	190	232	100	108	119	80	72	100	70	108	119	80	90	143	90
	1 1/4	32	—	—	—	120	142	90	80	122	80	120	142	90	105	150	90
	1 1/2	40	203	283	140	135	155	90	90	138	90	135	155	90	120	171	100
	2	50	283	353	180	155	186	115	100	153	100	155	186	115	140	189	115
	2 1/2	65	—	—	—	—	—	—	—	—	—	—	—	—	—	—	—
	3	80	305	470	225	—	—	—	—	—	—	—	—	—	—	—	—
	4	100	403	560	250	—	—	—	—	—	—	—	—	—	—	—	—
	5	125	—	—	—	—	—	—	—	—	—	—	—	—	—	—	—
	6	150	457	753	350	—	—	—	—	—	—	—	—	—	—	—	—
BODY		A351 Gr.CF8			SCS13A			SCS13A			SCS13A			SCS13A			
BONNET		A351 Gr.CF8			SCS13A			SCS13A			SUS304			SCS13A			
STEM		TYPE 304			SUS304			SUS304			SUS304			SUS304			
DISC		A351 Gr.CF8			SUS304			SUS304			SUS304			PTFE			
		Full Jacketed												Soft Seated disc			

TYPE		B-SEREAS GLOBE			B-SEREAS GLOBE			B-SEREAS GLOBE			B-SEREAS GLOBE			B-SEREAS GLOBE			
Stainless Steel																	
FIG		UDM			UDB			UDBM			UJ			UJM			
PRESSURE		10K			10K			10K			10K			10K			
END CONNECTION		BS21 (JIS B0203)			JIS B2220			JIS B2220			BS21 (JIS B0203)			BS21 (JIS B0203)			
DIMENSIONS	inch	mm	L	H	D	L	H	D	L	H	D	L	H	D	L	H	D
	1/4	8	—	—	—	—	—	—	—	—	—	—	—	—	—	—	—
	3/8	10	55	109	60	—	—	—	—	—	—	55	109	60	55	109	60
	1/2	15	65	112	60	85	112	60	85	112	60	65	111	60	65	111	60
	3/4	20	80	113	70	95	113	70	95	113	70	80	112	70	80	112	70
	1	25	90	143	90	110	143	90	110	143	90	90	142	90	90	142	90
	1 1/4	32	105	150	90	130	150	90	130	150	90	105	150	90	105	150	90
	1 1/2	40	120	171	100	150	171	100	150	171	100	120	171	100	120	171	100
	2	50	140	189	115	180	189	115	180	189	115	140	189	115	140	189	115
	2 1/2	65	—	—	—	210	252	180	210	252	180	180	253	180	180	253	180
	3	80	—	—	—	240	277	225	240	277	225	200	280	225	200	280	225
	4	100	—	—	—	—	—	—	—	—	—	—	—	—	—	—	—
	5	125	—	—	—	—	—	—	—	—	—	—	—	—	—	—	—
	6	150	—	—	—	—	—	—	—	—	—	—	—	—	—	—	—
BODY		SCS14A			SCS13A			SCS14A			SCS13A			SCS14A			
BONNET		SCS14A			SCS13A			SCS14A			SCS13A			SCS14A			
STEM		SUS316			SUS304			SUS316			SUS304			SUS316			
DISC		PTFE			PTFE			PTFE			SUS304 / SCS13A			SUS316 / SCS14A			
		Soft Seated disc			Soft Seated disc			Soft Seated disc									





TYPE		B-SEREAS GLOBE			B-SEREAS GLOBE			A-SEREAS GLOBE			A-SEREAS GLOBE			A-SEREAS GLOBE				
Stainless Steel																		
FIG		UJB			UJBM			10UPA / G-10UPA / 10UPAT			10UPAM / G-10UPAM / 10UPAMT			20UPA / G-20UPA / 20UPAT				
PRESSURE		10K			10K			10K			10K			20K				
END CONNECTION		JIS B2220			JIS B2220			JIS B2220			JIS B2220			JIS B2220				
DIMENSIONS		inch	mm	L	H	D	L	H	D	L	H	D	L	H	D	L	H	D
		3/8	10	85	109	60	85	109	60	—	—	—	—	—	—	—	—	—
		1/2	15	85	111	60	85	111	60	108	168	90	108	168	90	152	186	100
		3/4	20	95	112	70	95	112	70	117	168	90	117	168	90	178	186	100
		1	25	110	142	90	110	142	90	127	173	100	127	173	100	203	187	100
		1 1/4	32	130	150	90	130	150	90	140	190	120	140	190	120	—	—	—
		1 1/2	40	150	171	100	150	171	100	165	205	140	165	205	140	229	236	160
		2	50	180	189	115	180	189	115	203	235	160	203	235	160	267	289	180
		2 1/2	65	210	253	180	210	253	180	216	248	180	216	248	180	292	297	200
		3	80	240	280	225	240	280	225	241	291	200	241	291	200	318	343	250
		4	100	—	—	—	—	—	—	292	325	225	292	325	225	356	398	300
		5	125	—	—	—	—	—	—	356	380	250	356	380	250	400	493	350
		6	150	—	—	—	—	—	—	406	453	350	406	453	350	444	564	400
		8	200	—	—	—	—	—	—	495	559	400	495	559	400	559	874	500
		10	250	—	—	—	—	—	—	622	924	500	622	924	500	622	1048	600
		12	300	—	—	—	—	—	—	698	1011	500	698	1011	500	—	—	—
BODY		SCS13A			SCS14A			SCS13A			SCS14A			SCS13A				
BONNET		SCS13A			SCS14A			SCS13A			SCS14A			SCS13A				
STEM		SUS304			SUS316			SUS304			SUS316			SUS304				
DISC		SUS304 / SCS13A			SUS316 / SCS14A			SCS13A			SUS316 / SCS14A			SUS304 / SCS13A				
								Fig. 10UPAT : Gland Packing / PTFE SIZE.10 & 12 Gear operation type			Fig. 10UPAMT : Gland Packing / PTFE SIZE.10 & 12 Gear operation type			Fig. 20UPAT : Gland Packing / PTFE SIZE.8 & 10 Gear operation type				

TYPE		A-SEREAS GLOBE			A-SEREAS GLOBE			A-SEREAS GLOBE			A-SEREAS GLOBE			A-SEREAS GLOBE				
Stainless Steel																		
FIG		20UPAM / G-20UPAM / 20UPAMT			150UPA / G-150UPA / 150UPAT			150UPAM / G-150UPAMT / 150UPAMT			300UPA / G-300UPA			300UPAM / G-300UPAM				
PRESSURE		20K			Class 150			Class 150			Class 300			Class 300				
END CONNECTION		JIS B2220			ASME B16.5			ASME B16.5			ASME B16.5			ASME B16.5				
DIMENSIONS		inch	mm	L	H	D	L	H	D	L	H	D	L	H	D	L	H	D
		3/8	10	—	—	—	—	—	—	—	—	—	—	—	—	—	—	—
		1/2	15	152	186	100	108	168	90	108	168	90	152	186	100	152	186	100
		3/4	20	178	186	100	117	168	90	117	168	90	178	186	100	178	186	100
		1	25	203	187	100	127	173	100	127	173	100	203	187	100	203	187	100
		1 1/4	32	—	—	—	—	—	—	—	—	—	—	—	—	—	—	—
		1 1/2	40	229	236	160	165	205	140	165	205	140	229	236	160	229	236	160
		2	50	267	289	180	203	235	160	203	235	160	267	289	180	267	289	180
		2 1/2	65	292	297	200	216	248	180	216	248	180	292	297	200	292	297	200
		3	80	318	343	250	241	291	200	241	291	200	318	343	250	318	343	250
		4	100	356	398	300	292	325	225	292	325	225	356	398	300	356	398	300
		5	125	400	493	350	356	380	250	356	380	250	400	493	350	400	493	350
		6	150	444	564	400	406	453	350	406	453	350	444	564	400	444	564	400
		8	200	—	—	—	495	559	400	495	559	400	559	883	500	559	874	500
		10	250	—	—	—	622	924	500	622	924	500	622	1054	600	622	1048	600
		12	300	—	—	—	698	1011	500	698	1011	500	—	—	—	—	—	—
BODY		SCS14A			A351 Gr.CF8			A351 Gr.CF8M			A351 Gr.CF8			A351 Gr.CF8M				
BONNET		SCS14A			A351 Gr.CF8			A351 Gr.CF8M			A351 Gr.CF8			A351 Gr.CF8M				
STEM		SUS316			A276 TYPE304			A276 TYPE316			A276 TYPE304 / TYPE304			A276 TYPE316 / TYPE316				
DISC		SUS316			A351 Gr.CF8			A276 TYPE316			A276 TYPE304 / A351 Gr.CF8			A351 Gr.CF8M				
		Fig. 20UPAMT : Gland Packing / PTFE SIZE.8 & 10 Gear operation type			Fig. 150UPAT : Gland Packing / PTFE SIZE.10 & 12 Gear operation type			Fig. 150UPAMT : Gland Packing / PTFE SIZE.10 & 12 Gear operation type			SIZE.8 & 10 Gear operation type			SIZE.8 & 10 Gear operation type				

Bronze & Brass  
 Cast Iron  
 Ductile Iron  
 Stainless Steel  
 Carbon Steel  
 Battery Valve  
 Ball Valve  
 Ball Valve Seat  
 Actuated Valve

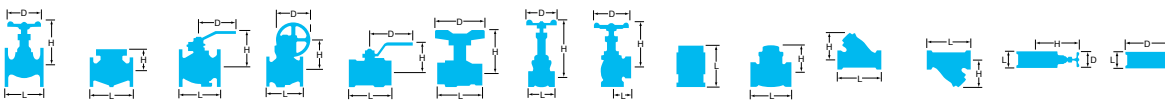

TYPE		A-SEREAS GLOBE			A-SEREAS GLOBE			A-SEREAS GLOBE			A-SEREAS GLOBE			A-SEREAS GLOBE			
Stainless Steel																	
FIG		600UPA			600UPAM			10UPAJ			20UPAJ			150UPAJ			
PRESSURE		600LB			600LB			10K			20K			Class 150			
END CONNECTION		ASME B16.5			ASME B16.5			JIS B2220			JIS B2220			ASME B16.5			
DIMENSIONS	inch	mm	L	H	D	L	H	D	L	H	D	L	H	D	L	H	D
	1/2	15	165	212	120	165	212	120	156	186	100	160	186	100	152	186	100
	3/4	20	190	210	120	190	210	120	156	186	100	160	186	100	152	186	100
	1	25	216	245	160	216	245	160	190	187	100	194	187	100	190	187	100
	1 1/2	40	241	282	200	241	282	200	214	236	160	218	236	160	213	236	160
	2	50	292	372	225	292	372	225	239	237	160	254	289	180	241	237	160
	2 1/2	65	330	411	250	330	411	250	-	-	-	-	-	-	-	-	-
	3	80	356	490	350	356	490	350	280	293	200	302	343	250	292	293	200
	4	100	432	584	400	432	584	400	349	326	225	339	398	300	356	326	225
	5	125	-	-	-	-	-	-	-	-	-	-	-	-	-	-	-
	6	150	559	742	600	559	742	600	-	-	-	-	-	-	-	-	-
BODY		A351 Gr.CF8			A351 Gr.CF8M			SCS13A			SCS13A			A351 Gr.CF8			
BONNET		A351 Gr.CF8			A351 Gr.CF8M			SCS13A			SCS13A			A351 Gr.CF8			
STEM		A276 TYPE304			A276 TYPE316			SUS304			SUS304			TYPE304			
DISC		A276 TYPE304			A276 TYPE316			SCS13A			SUS304			TYPE304			
								Full Jacketed			Full Jacketed			Full Jacketed			

TYPE		A-SEREAS GLOBE			A-SEREAS GLOBE			A-SEREAS GLOBE			A-SEREAS GLOBE			A-SEREAS GLOBE			
Stainless Steel																	
FIG		300UPAJ			10UPAW			10UPAWM			20UPAW			20UPAWM			
PRESSURE		Class 300			10K			10K			20K			20K			
END CONNECTION		ASME B16.5			JIS B2220			JIS B2220			JIS B2220			JIS B2220			
DIMENSIONS	inch	mm	L	H	D	L	H	D	L	H	D	L	H	D	L	H	D
	1/2	15	165	186	100	108	166	90	108	166	90	152	184	100	152	184	100
	3/4	20	165	186	100	117	166	90	117	166	90	178	184	100	178	184	100
	1	25	203	187	100	127	169	100	127	169	100	203	185	100	203	185	100
	1 1/2	40	229	236	160	165	201	140	165	201	140	229	234	160	229	234	160
	2	50	267	289	180	203	231	160	203	231	160	267	287	180	267	287	180
	2 1/2	65	-	-	-	216	244	180	216	244	180	292	293	200	292	293	200
	3	80	318	343	250	241	283	200	241	283	200	318	402	250	318	402	250
	4	100	356	398	300	292	363	225	292	363	225	356	453	300	356	453	300
	5	125	-	-	-	356	425	250	356	425	250	400	538	350	400	538	350
	6	150	-	-	-	406	482	350	406	482	350	444	606	400	444	606	400
BODY		A351 Gr.CF8			SCS13A			SCS14A			SCS13A			SCS14A			
BONNET		A351 Gr.CF8			SCS13A			SCS14A			SCS13A			SCS14A			
STEM		TYPE304			SUS304			SUS304			SUS304			SUS304			
DISC		TYPE304			SUS316 / SCS14A			SUS316 / SCS14A			SUS316 / SCS14A			SUS316 / SCS14A			
		Full Jacketed			Bellows seal globe valve			Bellows seal globe valve			Bellows seal globe valve			Bellows seal globe valve			

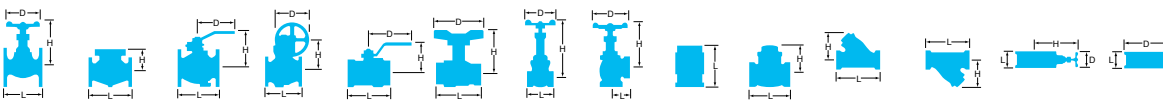

TYPE		A-SEREAS GLOBE			A-SEREAS GLOBE			A-SEREAS GLOBE			A-SEREAS GLOBE			B-SEREAS LIFT CHECK			
Stainless Steel																	
FIG		150UPAW			150UPAWM			300UPAW			300UPAWM			UN			
PRESSURE		Class 150			Class 150			Class 300			Class 300			10K			
END CONNECTION		ASME B16.5			ASME B16.5			ASME B16.5			ASME B16.5			BS21 (JIS B0203)			
DIMENSIONS	inch	mm	L	H	D	L	H	D	L	H	D	L	H	D	L	H	D
	3/8	10	—	—	—	—	—	—	—	—	—	—	—	—	55	50	24
	1/2	15	108	166	90	108	166	90	152	184	100	152	184	100	65	53	29
	3/4	20	117	166	90	117	166	90	178	184	100	178	184	100	80	54	35
	1	25	127	169	100	127	169	100	203	185	100	203	185	100	90	62	43
	1 1/4	32	—	—	—	—	—	—	—	—	—	229	234	160	105	66	53
	1 1/2	40	165	201	140	165	201	140	229	234	160	267	287	180	120	76	59
	2	50	203	231	160	203	231	160	267	287	180	292	293	200	140	85	74
	2 1/2	65	216	244	180	216	244	180	292	293	200	318	402	250	—	—	—
	3	80	241	283	200	241	283	200	318	402	250	356	453	300	—	—	—
	4	100	292	363	225	292	363	225	356	453	300	400	538	350	—	—	—
	5	125	356	425	250	356	425	250	400	538	350	444	606	400	—	—	—
	6	150	406	482	350	406	482	350	444	606	400	—	—	—	—	—	—
BODY		A351 Gr.CF8			A351 Gr.CF8M			A351 Gr.CF8			A351 Gr.CF8M			SCS13A			
BONNET		A351 Gr.CF8			A351 Gr.CF8M			A351 Gr.CF8			A351 Gr.CF8M			—			
CAP		—			—			—			—			CF8 / TYPE 304			
STEM		TYPE304			A276 TYPE304			TYPE304			A276 TYPE304			—			
DISC		TYPE316 / A351 Gr.CF8M			A276 TYPE316 / A351 Gr.CF8M			TYPE316 / A351 Gr.CF8M			A276 TYPE316 / A351 Gr.CF8M			SCS13A / SUS304			
		Bellows seal globe valve			Bellows seal globe valve			Bellows seal globe valve			Bellows seal globe valve						

TYPE		B-SEREAS SWING CHECK			B-SEREAS SWING CHECK			B-SEREAS SWING CHECK			B-SEREAS SWING CHECK			A-SEREAS LIFT CHECK			
Stainless Steel																	
FIG		UO			UOM			UOB			UOBM			10UNA / 10UNAT			
PRESSURE		10K			10K			10K			10K			10K			
END CONNECTION		JIS B2220			BS21 (JIS B0203)			JIS B2220			JIS B2220			JIS B2220			
DIMENSIONS	inch	mm	L	H	D	L	H	D	L	H	D	L	H	D	L	H	D
	3/8	10	—	—	—	—	—	—	—	—	—	—	—	—	—	—	—
	1/2	15	65	45	29	65	45	29	85	45	95	85	45	95	108	74	95
	3/4	20	80	55	35	80	55	35	95	55	100	95	55	100	117	76	100
	1	25	90	61	44	90	61	44	110	61	125	110	61	125	127	76	125
	1 1/4	32	105	71	53	105	71	53	130	71	135	130	71	135	140	84	135
	1 1/2	40	120	72	59	120	72	59	150	72	140	150	72	140	165	86	140
	2	50	140	81	73	140	81	73	180	81	155	180	81	155	—	—	—
	2 1/2	65	180	93	89	180	93	89	210	93	175	210	93	175	—	—	—
	3	80	200	104	104	200	104	104	240	104	185	240	104	185	—	—	—
	4	100	—	—	—	—	—	—	—	—	—	—	—	—	—	—	—
	5	125	—	—	—	—	—	—	—	—	—	—	—	—	—	—	—
	6	150	—	—	—	—	—	—	—	—	—	—	—	—	—	—	—
BODY		SCS13A			SCS14A			SCS13A			SCS14A			SCS13A			
CAP		CF8 / TYPE 304			CF8M / TYPE316			CF8 / TYPE 304			CF8M / TYPE316			—			
COVER		—			—			—			—			SCS13A			
DISC		SCS13A			SCS14A			SCS13A			SCS14A			SUS304			
HINGE PIN		SUS304			SUS316			SUS304			SUS316			—			
														Fig. 10UNAT : Gasket / PTFE			

Bronze & Brass

Cast Iron

Ductile Iron

Stainless Steel

Carbon Steel

Butterfly Valve

Ball Valve

Ball Valve Seat

Actuated Valve

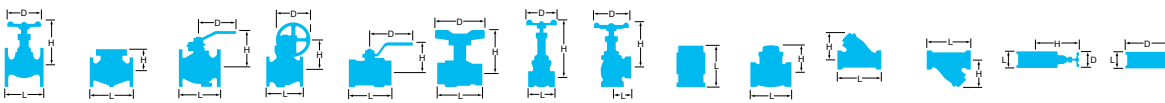

TYPE		A-SEREAS LIFT CHECK			A-SEREAS LIFT CHECK			A-SEREAS LIFT CHECK			A-SEREAS LIFT CHECK			A-SEREAS LIFT CHECK			
Stainless Steel																	
FIG		10UNAM / 10UNAMT			20UNA / 20UNAT			20UNAM / 20UNAMT			150UNA / 150UNAT			150UNAM			
PRESSURE		10K			20K			20K			Class 150			Class 150			
END CONNECTION		JIS B2220			JIS B2220			JIS B2220			ASME B16.5			ASME B16.5			
DIMENSIONS	inch	mm	L	H	D	L	H	D	L	H	D	L	H	D	L	H	D
	1/2	15	108	74	95	152	73	95	152	73	95	108	74	89	108	74	89
	3/4	20	117	76	100	178	73	100	178	73	100	117	76	98	117	76	98
	1	25	127	76	125	203	73	125	203	73	125	127	76	108	127	76	108
	1 1/4	32	140	84	135	-	-	-	-	-	-	-	-	-	-	-	-
1 1/2	40	165	86	140	229	90	140	229	90	140	165	86	127	165	86	127	
BODY		SCS14A			SCS13A			SCS14A			A351 Gr.CF8			A351 Gr.CF8M			
COVER		SCS14A			SCS13A			SCS14A			A351 Gr.CF8			A351 Gr.CF8M			
STEM		-			-			-			-			-			
DISC		SUS316			SUS304			SUS316			TYPE304			A276 TYPE316			
GASKET		Fig. 10UNAMT : Gasket / PTFE			Fig. 20UNAT : Gasket / PTFE			Fig. 20UNAMT : Gasket / PTFE			Fig. 150UNAT : Gasket / PTFE						

TYPE		A-SEREAS LIFT CHECK			A-SEREAS LIFT CHECK			A-SEREAS SWING CHECK			A-SEREAS SWING CHECK			A-SEREAS SWING CHECK			
Stainless Steel																	
FIG		300UNA			300UNAM			10UOA / 10UOAT			10UOAM / 10UOAMT			20UOA / 20UOAT			
PRESSURE		Class 300			Class 300			10K			10K			20K			
END CONNECTION		ASME B16.5			ASME B16.5			JIS B2220			JIS B2220			JIS B2220			
DIMENSIONS	inch	mm	L	H	D	L	H	D	L	H	D	L	H	D	L	H	D
	1/2	15	152	73	95	152	73	95	-	-	-	-	-	-	-	-	-
	3/4	20	178	73	117	178	73	117	-	-	-	-	-	-	-	-	-
	1	25	203	73	124	203	73	124	-	-	-	-	-	-	-	-	-
	1 1/4	32	-	-	-	-	-	-	-	-	-	-	-	-	-	-	-
	1 1/2	40	229	90	156	229	90	156	165	110	140	165	110	140	241	121	140
	2	50	-	-	-	-	-	-	203	120	155	203	120	155	267	143	155
	2 1/2	65	-	-	-	-	-	-	216	133	175	216	133	175	292	167	175
	3	80	-	-	-	-	-	-	241	147	185	241	147	185	318	182	200
	4	100	-	-	-	-	-	-	292	161	210	292	161	210	356	206	225
	5	125	-	-	-	-	-	-	330	191	250	330	191	250	400	236	270
	6	150	-	-	-	-	-	-	356	216	280	356	216	280	444	265	305
	8	200	-	-	-	-	-	-	495	264	330	495	264	330	533	295	350
10	250	-	-	-	-	-	-	622	287	400	622	287	400	622	363	430	
12	300	-	-	-	-	-	-	698	315	445	698	315	445	711	375	480	
14	350	-	-	-	-	-	-	787	363	490	787	363	490	-	-	-	
16	400	-	-	-	-	-	-	864	407	560	864	407	560	-	-	-	
BODY		A351 Gr.CF8			A351 Gr.CF8M			SCS13A			SCS14A			SCS13A			
COVER		A351 Gr.CF8			A351 Gr.CF8M			SCS13A			SCS14A			SCS13A			
STEM		-			-			-			-			-			
DISC		A276 TYPE304			A276 TYPE316			SUS13A			SCS14A			SCS13A			
HINGE PIN		-			-			SUS304			SUS316			SUS304			
GASKET								Fig. 10UOAT : Gasket / PTFE			Fig. 10UOAMT : Gasket / PTFE			Fig. 20UOAT : Gasket / PTFE			

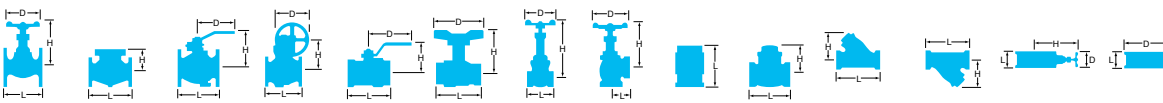

TYPE		A-SEREAS SWING CHECK			A-SEREAS SWING CHECK			A-SEREAS SWING CHECK			A-SEREAS SWING CHECK			A-SEREAS SWING CHECK			
Stainless Steel																	
FIG		20UOAM / 20UOAMT			150UOA / 150UOAT			150UOAM / 150UOAMT			300UOA			300UOAM			
PRESSURE		20K			Class 150			Class 150			Class 300			Class 300			
END CONNECTION		JIS B2220			ASME B16.5			ASME B16.5			ASME B16.5			ASME B16.5			
DIMENSIONS	inch	mm	L	H	D	L	H	D	L	H	D	L	H	D	L	H	D
	1½	40	241	121	140	165	110	127	165	110	127	241	121	156	241	121	156
	2	50	267	143	155	203	120	152	203	120	152	267	143	165	267	143	165
	2½	65	292	167	175	216	133	178	216	133	178	292	167	190	292	167	190
	3	80	318	182	200	241	147	190	241	147	190	318	182	210	318	182	210
	4	100	356	206	225	292	161	229	292	161	229	356	206	254	356	206	254
	5	125	400	236	270	330	191	254	330	191	254	400	236	279	400	236	279
	6	150	444	265	305	356	216	279	356	216	279	444	265	318	444	265	318
	8	200	533	295	350	495	264	343	495	264	343	533	295	381	533	295	381
	10	250	622	363	430	622	287	406	622	287	406	622	363	444	622	363	444
	12	300	711	375	480	698	315	483	698	315	483	711	375	521	711	375	521
	14	350	—	—	—	787	363	533	787	363	533	—	—	—	—	—	—
	16	400	—	—	—	864	407	597	864	407	597	—	—	—	—	—	—
BODY		SCS14A			A351 Gr.CF8			A351 Gr.CF8M			A351 Gr.CF8			A351 Gr.CF8M			
COVER		SCS14A			A351 Gr.CF8			A351 Gr.CF8M			A351 Gr.CF8			A351 Gr.CF8M			
STEM		—			—			—			—			—			
DISC		SCS14A			A351 Gr.CF8			A351 Gr.CF8M			A351 Gr.CF8			A351 Gr.CF8M			
HINGE PIN		SUS316			TYPE304			TYPE316			A276 TYPE304			A276 TYPE316			
		Fig. 20UOAMT : Gasket / PTFE			Fig. 150UOAT : Gasket / PTFE			Fig. 150UOAMT : Gasket / PTFE									

TYPE		A-SEREAS SWING CHECK			A-SEREAS SWING CHECK			WAFER CHECK			WAFER CHECK			
Stainless Steel														
FIG		600UOA			600UOAM			10UW			10UWS			
PRESSURE		600LB			600LB			10K			10K			
END CONNECTION		ASME B16.5			ASME B16.5			Wafer Type			Wafer Type			
DIMENSIONS	inch	mm	L	H	D	L	H	D	L	H	D	L	H	D
	½	15	165	90	95	165	90	95	—	—	—	—	—	—
	¾	20	190	95	117	190	95	117	—	—	—	—	—	—
	1	25	216	105	124	216	105	124	—	—	—	—	—	—
	1½	32	—	—	—	—	—	—	—	—	—	—	—	—
	1½	40	241	120	156	241	120	156	—	—	—	—	—	—
	2	50	292	180	165	292	180	165	60	147	60	60	147	60
	2½	65	330	205	190	330	205	190	67	155	60	67	155	60
	3	80	356	235	210	356	235	210	73	163	60	73	163	60
	4	100	432	270	273	432	270	273	73	175	60	73	175	60
	5	125	—	—	—	—	—	—	89	189	70	89	189	70
	6	150	559	330	356	559	330	356	98	202	70	98	202	70
	8	200	660	400	419	660	400	419	127	229	70	127	229	70
	10	250	—	—	—	—	—	—	146	280	90	146	280	90
	12	300	838	470	508	838	470	508	181	307	90	181	307	90
BODY		A351 Gr.CF8			A351 Gr.CF8M			SCS13A+NBR			SCS13A			
COVER		A351 Gr.CF8			A351 Gr.CF8M			—			—			
STEM		—			—			—			—			
DISC		A351 Gr.CF8			A351 Gr.CF8M			SCS13A			SCS13A			
HINGE PIN		TYPE304			TYPE316			SUS304			SUS304			

Bronze & Brass  
 Cast Iron  
 Ductile Iron  
 Stainless Steel  
 Carbon Steel  
 Battery Valve  
 Ball Valve  
 Ball Valve Seat  
 Actuated Valve

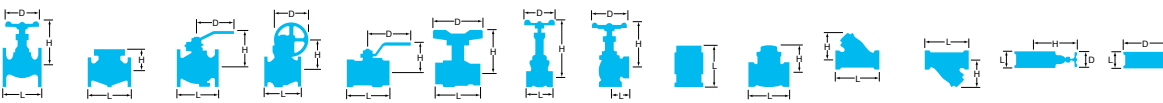

TYPE		A-SEREAS LIFT CHECK			A-SEREAS LIFT CHECK			A-SEREAS LIFT CHECK			A-SEREAS LIFT CHECK			A-SEREAS LIFT CHECK			
Stainless Steel																	
FIG		10UNAJ			10UNAJM			20UNAJ			150UNAJ			300UNAJ			
PRESSURE		10K			10K			20K			Class 150			Class 300			
END CONNECTION		JIS B2220			JIS B2220			JIS B2220			ASME B16.5			ASME B16.5			
DIMENSIONS		inch	mm	L	H	D	L	H	D	L	H	D	L	H	D		
	1/2	15	156	73	140	156	73	140	160	73	140	152	73	127	165	73	156
	3/4	20	156	73	140	156	73	140	160	73	140	152	73	127	165	73	156
	1	25	190	73	155	190	73	155	194	73	155	190	73	152	203	73	165
	1 1/2	40	214	90	175	214	90	175	218	90	175	213	90	178	229	90	190
BODY		SCS13A			SCS14A			SCS13A			A351 Gr.CF8			A351 Gr.CF8			
BONNET		SCS13A			SCS14A			SCS13A			A351 Gr.CF8			A351 Gr.CF8			
STEM		-			-			-			-			-			
DISC		SUS304			SUS316			SUS304			A276 TYPE316			TYPE304			
		Full Jacketed			Full Jacketed			Full Jacketed			Full Jacketed			Full Jacketed			

TYPE		A-SEREAS SWING CHECK			A-SEREAS SWING CHECK			A-SEREAS SWING CHECK			A-SEREAS SWING CHECK				
Stainless Steel															
FIG		10UOAJ			20UOAJ			150UOAJ			300UOAJ				
PRESSURE		10K			20K			Class 150			Class 300				
END CONNECTION		JIS B2220			JIS B2220			ASME B16.5			ASME B16.5				
DIMENSIONS		inch	mm	L	H	D	L	H	D	L	H	D	L	H	D
	1 1/2	40	-	-	-	-	-	-	-	-	-	-	-	-	-
	2	50	239	122	185	254	146	200	241	122	190	267	146	210	
	2 1/2	65	-	-	-	-	-	-	-	-	-	-	-	-	
	3	80	280	149	210	314	180	225	292	149	229	330	180	254	
	4	100	349	171	280	383	200	305	356	171	279	400	200	318	
	6	150	393	214	330	421	255	350	406	214	343	444	255	381	
8	200	-	-	-	-	-	-	-	-	-	-	-	-	-	
BODY		SCS13A			SCS13A			A351 Gr.CF8			A351 Gr.CF8				
COVER		SCS13A			SCS13A			A351 Gr.CF8			A351 Gr.CF8				
STEM		-			-			-			-				
DISC		SCS13A			SCS13A			A351 Gr.CF8			A351 Gr.CF8				
HINGE PIN		SUS304			SUS304			TYPE304			TYPE304				
		Full Jacketed			Full Jacketed			Full Jacketed			Full Jacketed				

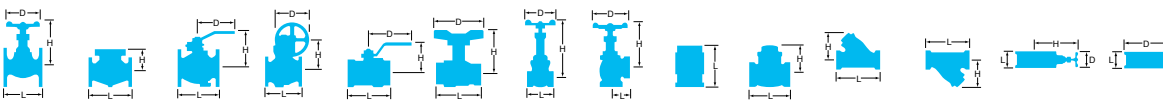

TYPE		BALL CHECK			BALL CHECK			B-SEREAS Y TYPE STRAINER			B-SEREAS Y TYPE STRAINER			B-SEREAS Y TYPE STRAINER			
Stainless Steel																	
FIG		10UFTE			10UFTE			UY			UYM			UYB			
PRESSURE		10K			10K			20K			20K			10K			
END CONNECTION		JIS B2220			JIS B2220			BS21 (JIS B0203)			BS21 (JIS B0203)			JIS B2220			
DIMENSIONS		inch	mm	L	H	D	L	H	D	L	H	D	L	H	D		
	1/4	8	—	—	—	—	—	—	—	65	50	21	65	50	21		
	3/8	10	—	—	—	—	—	—	—	70	50	23	70	50	23		
	1/2	15	—	—	—	—	—	—	—	85	60	29	85	60	29		
	3/4	20	—	—	—	—	—	—	—	100	65	35	100	65	35		
	1	25	—	—	—	—	—	—	—	115	77	43	115	77	43		
	1 1/4	32	—	—	—	—	—	—	—	135	90	54	135	90	54		
	1 1/2	40	190	87	140	—	—	—	—	150	100	61	150	100	61		
	2	50	200	100.5	155	200	100.5	155	180	115	73	180	115	73	220	122	155
	2 1/2	65	220	123.5	175	220	123.5	175	220	150	90	220	150	90	—	—	—
	3	80	240	150	185	240	150	185	250	193	105	250	193	105	—	—	—
	4	100	290	187	210	290	187	210	—	—	—	—	—	—	—	—	—
	6	150	410	275	280	410	275	280	—	—	—	—	—	—	—	—	—
8	200	—	—	—	500	366	330	—	—	—	—	—	—	—	—	—	
BODY		CF8			CF8			SCS13A			SCS14A			SCS13A			
COVER		CF8			CF8			—			—			—			
CAP		—			—			CF8 / TYPE 304			CF8M / TYPE316			CF8 / TYPE 304			
DISC		NBR			NBR			—			—			—			
SCREEN		—			—			SUS304			SUS316			SUS304			

TYPE		B-SEREAS Y TYPE STRAINER			A-SEREAS Y TYPE STRAINER			A-SEREAS Y TYPE STRAINER			A-SEREAS Y TYPE STRAINER			
Stainless Steel														
FIG		UYBM			10UYA			10UYAM			20UYA			
PRESSURE		10K			10K			10K			20K			
END CONNECTION		JIS B2220			JIS B2220			JIS B2220			JIS B2220			
DIMENSIONS		inch	mm	L	H	D	L	H	D	L	H	D		
	3/8	10	110	50	90	—	—	—	—	—	—	—		
	1/2	15	120	58	95	—	—	—	—	160	70	95		
	3/4	20	130	66	100	—	—	—	—	160	80	100		
	1	25	150	78	125	—	—	—	—	190	92	125		
	1 1/4	32	170	93	135	—	—	—	—	—	—	—		
	1 1/2	40	190	104	140	—	—	—	—	240	125	140		
	2	50	220	122	155	—	—	—	—	250	150	155		
	2 1/2	65	—	—	—	270	160	175	270	160	175	300	160	175
	3	80	—	—	—	290	197	185	290	197	185	320	197	200
	4	100	—	—	—	350	233	210	350	233	210	380	246	225
	5	125	—	—	—	390	267	250	390	267	250	—	—	—
	6	150	—	—	—	440	320	280	440	320	280	550	342	305
8	200	—	—	—	540	380	330	540	380	330	600	430	350	
10	250	—	—	—	760	538	440	760	538	440	760	538	430	
12	300	—	—	—	870	635	445	870	635	445	870	635	480	
BODY		SCS14A			SCS13A			CF8M			SCS13A			
CAP		CF8M / TYPE316			—			—			—			
COVER		—			SCS13A			CF8M			SCS13A			
DISC		—			—			—			—			
SCREEN		SUS316			SUS304			TYPE316			SUS304			

Bronze & Brass  
 Cast Iron  
 Ductile Iron  
 Stainless Steel  
 Carbon Steel  
 Battery Valve  
 Ball Valve  
 Ball Valve Seat  
 Actuated Valve

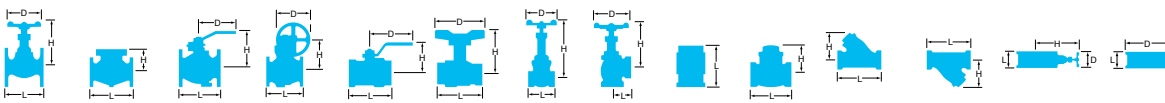

TYPE	NEEDLE				NEEDLE			NEEDLE			NEEDLE			NEEDLE		
mm. Serie																
FIG	UN3-AP-				UN3-BP-			UN3-CP-			UN3-DP-			UN3-EP-		
PRESSURE	30K				30K			30K			30K			30K		
END CONNECTION	BS21 (JIS B0203)				BS21 (JIS B0203)			COUPLE LOK			COUPLE LOK			JIS B0203 / COUPLE LOK		
DIMENSIONS	mm	L	H	D	L	H	D	L	H	D	L	H	D	L	H	D
	6	40	59	40	15	59	40	60.8	59	40	30.4	59	40	55.4	59	40
	8	40	59	40	15	59	40	60.8	59	40	30.4	59	40	55.4	59	40
	10	45	64	40	18	64	40	62.4	64	40	—	—	—	56.2	64	40
	10	—	—	—	—	—	—	—	—	—	—	—	—	56.2	64	40
	12	55	79	50	—	—	—	70.2	64	40	—	—	—	60.1	64	40
	12	—	—	—	—	—	—	—	—	—	—	—	—	60.1	64	40
BODY	SUS 316				SUS 316			SUS 316			SUS 316			SUS 316		
STEM	SUS630				SUS630			SUS630			SUS630			SUS630		
FIG	Rc1/8": UN3-AP-1 Rc1/4": UN3-AP-2 Rc3/8": UN3-AP-3 Rc1/2": UN3-AP-4				Rc1/8": UN3-BP-1 Rc1/4": UN3-BP-2 Rc3/8": UN3-BP-3			6mm : UN3-CP-6 8mm : UN3-CP-8 10mm : UN3-CP-10 12mm : UN3-CP-12			6mm : UN3-DP-6 8mm : UN3-DP-8			6mm x R1/4": UN3-EP-6-2 8mm x R1/4": UN3-EP-8-2 10mm x R3/8": UN3-EP-10-2 12mm x R1/2": UN3-EP-12-2 12mm x R3/8": UN3-EP-12-3		

TYPE	NEEDLE				NEEDLE			NEEDLE			NEEDLE		
mm. Serie													
FIG	UN3-FP-				UN26-AP-			UN26-CP-			UN26-SP-		
PRESSURE	30K				260K			260K			260K		
END CONNECTION	JIS B0203 / COUPLE LOK				BS21 (JIS B0203)			COUPLE LOK			JIS B2316		
DIMENSIONS	mm	L	H	D	L	H	D	L	H	D	L	H	D
	6	30.4	59	40	48	69	40	64.8	69	40	60	69	40
	8	30.4	59	40	48	69	40	64.8	69	40	60	69	40
	10	31.2	64	40	55	82	70	68.4	83	50	65	82	70
	12	35.1	64	40	—	—	—	74.7	83	50	—	—	—
	15	—	—	—	60	87	70	—	—	—	75	87	70
	20	—	—	—	70	104	85	—	—	—	85	104	85
	25	—	—	—	85	122	85	—	—	—	100	122	85
BODY	SUS 316				SUS 316			SUS 316			SUS 316		
STEM	SUS630				SUS630			SUS630			SUS630		
FIG	6mm x R1/8": UN3-FP-6-2 8mm x R1/4": UN3-FP-8-2 10mm x R1/4": UN3-FP-10-2 10mm x R3/8": UN3-FP-10-3 12mm x R1/2": UN3-FP-12-2 12mm x R3/8": UN3-FP-12-3				Rc1/8": UN26-AP-1 Rc1/4": UN26-AP-2 Rc3/8": UN26-AP-3 Rc1/2": UN26-AP-4 Rc3/4": UN26-AP-5 Rc1": UN26-AP-6			6mm : UN26-CP-6 8mm : UN26-CP-8 10mm : UN26-CP-10 12mm : UN26-CP-12			1/8": UN26-SP-1 1/4": UN26-SP-2 3/8": UN26-SP-3 1/2": UN26-SP-4 3/4": UN26-SP-5 1": UN26-SP-6		

TYPE	NEEDLE				NEEDLE			NEEDLE			NEEDLE			NEEDLE			
Inch Serie																	
FIG	UN3-CP-				UN3-DP-			UN3-EP-			UN3-FP-			UN26-CP-			
PRESSURE	30K				30K			30K			30K			260K			
END CONNECTION	COUPLE LOK				COUPLE LOK			JIS B0203 / COUPLE LOK			JIS B0203 / COUPLE LOK			COUPLE LOK			
DIMENSIONS	inch	L	H	D	L	H	D	L	H	D	L	H	D	L	H	D	
	1/8	6	—	—	—	—	—	—	—	—	—	—	—	—	—	—	
	1/4	8	60.8	59	40	30.4	59	40	55.4	59	40	30.4	59	40	64.8	69	40
	3/8	10	62.4	64	40	—	—	—	56.2	64	40	31.2	64	40	68.4	83	50
	3/8	12	—	—	—	—	—	—	—	—	—	—	—	—	—	—	—
	1/2	15	70.2	64	40	—	—	—	—	—	—	—	—	—	74.7	83	50
BODY	SUS 316				SUS 316			SUS 316			SUS 316			SUS 316			
STEM	SUS630				SUS630			SUS630			SUS630			SUS630			
FIG	1/4": UN3-CP-02 3/8": UN3-CP-03 1/2": UN3-CP-04				1/4": UN3-DP-02			1/4": UN3-EP-02-2 3/8": UN3-EP-03-2 3/8": UN3-EP-03-3			1/4": UN3-FP-02-2 3/8": UN3-FP-03-2 3/8": UN3-FP-03-3			1/4": UN26-CP-02 3/8": UN26-CP-03 1/2": UN26-CP-04			



# CARBON STEEL

# Carbon Steel

## General Design Specifications

Items	American Std.	British Std.
Shell wall thickness and general valve design	API 600	BS 1414 (Gate valve) BS 1873 (Globe valve) BS 1868 (Check valve)
Pressure-temperature ratings	ASME B16.34	BS 1560
Face-to-face dimensions End-to-end dimensions	ASME B16.10	BS 2080
End flange dimensions Gasket contact facing	ASME B16.5*	BS 1560
Welding end dimensions	ASME B16.25	BS 1414 (Gate valve) BS 1873 (Globe valve) BS 1868 (Check valve)

\*MSS SP-44 for Nominal size 22 and ASME B16.47 Series B for Nominal size 26 and larger, for end flange dimensions.

## Mounting of Body Seat Rings

Body seat rings of KITZ cast steel valves are mounted on the valve body by seal welding as shown in the typical examples of gate valves illustrated below. Unless specifically requested in advance, mounting of body seat rings shall be made at the manufacturer's discretion. Specify your own method of mounting, noting your purchase orders with adequate KITZ product code numbers.

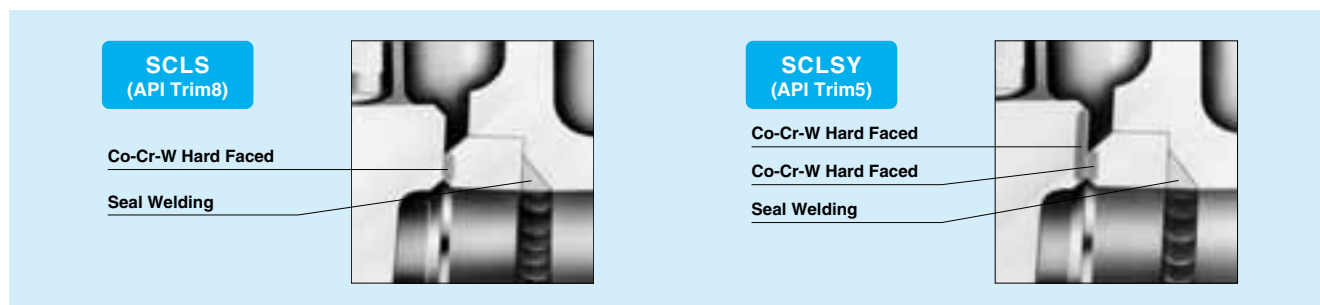

For KITZ cast steel valves made of ASTM A216 WCB, the standard shell material, disc seats and body seat rings shall be provided as follows. (Refer to Page 45 for Product Coding)

KITZ Product Code	Standard Disc Seat	Standard Body Seat	Mounting of Body Seat Rings
SCLS (Gate) SCJS (Globe) SCOS (Check)	F6a or WCB + 13Cr or A105 + 13Cr or CA15	A105 + HF* or A106 Gr. B + HF* or AISI 1022 + HF* or Direct HF**	Seal Welded or Direct HF**
SCLSY (Gate) SCJSY (Globe) SCOSY (Check)	A105 + HF* or WCB + HF* or CA15 + HF*	A105 + HF* or A106 Gr. B + HF* or AISI 1022 + HF* or Direct HF**	Seal Welded or Direct HF**

\* Co-Cr-W Alloy deposited for hard facing.

\*\* Co-Cr-W Alloy is directly deposited on valve body for hard facing.

KITZ Product Code 900SCJS, 900SCJSY, 1500SCJS, 1500SCJSY, 2500SCJS and 2500SCJSY globe valves employ this hard facing.

## Bonnet Gasket Materials

Depending on class ratings and servicing conditions, following gasket materials are available for body/bonnet flange gaskets of KITZ cast steel valves. Specify your gasket material in purchase order.

Gasket Material	Class					
	150	300	600	900	1500	2500
Corrugated metal with flexible graphite	●					
Ring joint metal			●	●	●	●
Spiral wound metal, flexible graphite filled		●				
Stainless steel inserted flexible graphite	●					

Please refer to our website ([www.kitz.co.jp](http://www.kitz.co.jp)) or contact KITZ for details.

### Product Coding

**G- 150 SC LS6CY**

5 4 1 2 3

- 1 ASME pressure class:**  
150 through 2500

- 2 Shell material code:**  
Carbon and low alloy steel are always identified as "SC"

- 3 Other valve specifications:**

**L S 6C Y**

a b c b

- a Valve type code:**  
L... Gate valve  
J... Globe valve  
O... Swing check valve

- b Seat material/mounting:**

Code	Disc Seat Material	Body Seat Material	Type of Mounting
S□	13Cr	HF	Refer to Page 6
S□Y	HF	HF	

□: Special shell material code

- c Special shell material:**  
No code is required for WCB.

- 4 Type of end connection:**  
No code is required for RF-flanged ends  
W... Butt-welding ends.

- 5 Type of valve operation:**  
No code is required for manual handwheel operation.  
G ... Gear operation.  
E ... Electric actuator operation.

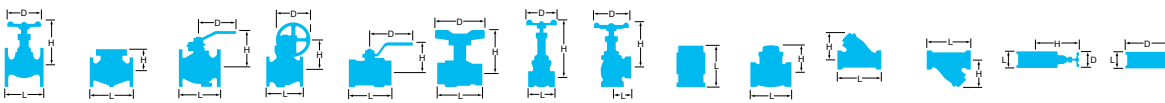

Please refer to our website ([www.kitz.co.jp](http://www.kitz.co.jp)) or contact KITZ for details.

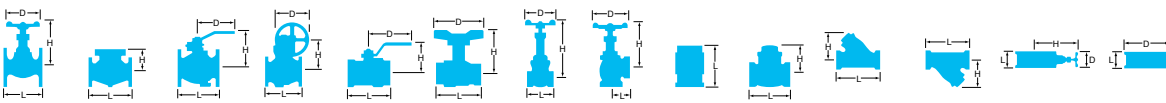

TYPE		GATE					GATE				GATE			GLOBE					
Carbon Steel																			
FIG		10SCLS					20SCLS				150SCLS			300SCLS			10SCJS		
PRESSURE		10K					20K				Class 150			Class 300			10K		
END CONNECTION		JIS B2220					JIS B2220				ASME B16.5			ASME B16.5			JIS B2220		
DIMENSIONS	inch	mm	L	H	D	L	H	D	L	H	D	L	H	D	L	H	D		
	1½	40	—	—	—	—	—	—	165	385	200	—	—	—	—	—	—		
	2	50	178	385	200	216	411	200	178	385	200	216	411	200	203	332	200		
	2½	65	190	432	200	241	454	200	190	432	200	241	454	200	216	379	250		
	3	80	203	509	250	283	528	250	203	509	250	283	528	250	241	390	250		
	4	100	229	592	250	305	613	250	229	592	250	305	613	250	292	460	250		
	5	125	254	658	300	381	692	300	254	658	300	381	692	300	356	484	300		
	6	150	267	758	300	403	790	350	267	758	300	403	790	350	406	513	350		
	8	200	292	958	350	419	1013	400	292	958	350	419	1013	400	—	—	—		
	10	250	330	1162	400	457	1215	450	330	1162	400	457	1215	450	—	—	—		
	12	300	356	1362	450	502	1458	600	356	1362	450	502	1458	600	—	—	—		
	14	350	381	1572	600	762	1561	600	381	1572	600	762	1561	600	—	—	—		
	16	400	406	1692	600	838	1741	680	406	1692	600	838	1741	680	—	—	—		
	18	450	432	1888	600	914	1931	680	432	1888	600	914	1931	680	—	—	—		
	20	500	457	2123	680	991	2137	760	457	2123	680	991	2137	760	—	—	—		
	24	600	508	2497	760	1143	2540	910	508	2497	760	1143	2540	910	—	—	—		
BODY		SCPH2 / A216 Gr.WCB					SCPH2 / A216 Gr.WCB				SCPH2 / A216 Gr.WCB			SCPH2 / A216 Gr.WCB			SCPH2 / A216 Gr.WCB		
BONNET		SCPH2 / A216 Gr.WCB					SCPH2 / A216 Gr.WCB				SCPH2 / A216 Gr.WCB			SCPH2 / A216 Gr.WCB			SCPH2 / A216 Gr.WCB		
STEM		A182 Gr.F6A					A182 Gr.F6A				A182 Gr.F6A			A182 Gr.F6A			A182 Gr.F6A		
DISC		A182 Gr.F6A / A216 Gr.WCB+13Cr					A182 Gr.F6A / A216 Gr.WCB+13Cr				A182 Gr.F6A / A216 Gr.WCB+13Cr			A182 Gr.F6A / A216 Gr.WCB+13Cr			A182 Gr.F6A / A216 Gr.WCB+13Cr		

TYPE		GLOBE					GLOBE				GLOBE			SWING CHECK			SWING CHECK		
Carbon Steel																			
FIG		20SCJS / G-20SCJS					150SCJS / G-150SCJS				300SCJS / G-300SCJS			10SCOS			20SCOS		
PRESSURE		20K					Class 150				Class 300			10K			20K		
END CONNECTION		JIS B2220					JIS B2220				JIS B2220			JIS B2220			JIS B2220		
DIMENSIONS	inch	mm	L	H	D	L	H	D	L	H	D	L	H	D	L	H	D		
	1½	40	—	—	—	165	332	200	229	362	200	—	—	—	—	—	—		
	2	50	267	362	200	203	332	200	267	362	200	203	152	155	267	165	155		
	2½	65	292	433	250	216	379	250	292	433	250	216	170	175	292	190	175		
	3	80	318	436	250	241	390	250	318	436	250	241	180	185	318	205	200		
	4	100	356	510	350	292	460	250	356	510	350	292	200	210	356	225	225		
	5	125	400	610	400	356	484	300	400	610	400	330	235	250	400	250	270		
	6	150	444	990	500	406	513	350	444	990	500	356	250	280	444	272	305		
	8	200	559	1062	500	495	929	500	559	1062	500	495	295	330	533	330	430		
	10	250	622	1143	600	622	979	500	622	1143	600	622	334	400	622	360	480		
	12	300	711	1188	600	698	1049	500	711	1188	600	698	368	445	711	406	540		
	14	350	—	—	—	—	—	—	—	—	—	787	415	490	838	480	605		
	16	400	—	—	—	—	—	—	—	—	—	864	460	560	864	535	675		
	18	450	—	—	—	—	—	—	—	—	—	978	510	620	978	575	730		
	20	500	—	—	—	—	—	—	—	—	—	978	583	675	1016	630	845		
	24	600	—	—	—	—	—	—	—	—	—	1295	630	795	—	—	—		
BODY		SCPH2 / A216 Gr.WCB					SCPH2 / A216 Gr.WCB				SCPH2 / A216 Gr.WCB			SCPH2 / A216 Gr.WCB			SCPH2 / A216 Gr.WCB		
BONNET		SCPH2 / A216 Gr.WCB					SCPH2 / A216 Gr.WCB				SCPH2 / A216 Gr.WCB			—			—		
COVER		—					—				—			SCPH2 / A216 Gr.WCB			SCPH2 / A216 Gr.WCB		
STEM		A182 Gr.F6A					A182 Gr.F6A				A182 Gr.F6A			—			—		
HINGE PIN		—					—				—			A276 TYPE403			A276 TYPE403		
DISC		A182 Gr.F6A / A216 Gr.WCB+13Cr SIZE:6-12 Gear operation type					A182 Gr.F6A / A216 Gr.WCB+13Cr / A105+13Cr SIZE:8-12 Gear operation type				A182 Gr.F6A / A216 Gr.WCB+13Cr / A105+13Cr SIZE:6-12 Gear operation type			A182 Gr.F6A / A216 Gr.WCB+13Cr			A182 Gr.F6 / WCB+13Cr		



TYPE		SWING CHECK				SWING CHECK			
Carbon Steel									
FIG		150SCOS				300SCOS			
PRESSURE		Class 150				Class 300			
END CONNECTION		JIS B2220				JIS B2220			
DIMENSIONS	inch	mm	L	H	D	L	H	D	
	1 1/2	40	165	135	127	241	155	156	
	2	50	203	152	152	267	165	165	
	2 1/2	65	216	170	178	292	190	190	
	3	80	241	180	190	318	205	210	
	4	100	292	200	229	356	225	254	
	5	125	330	235	254	400	250	279	
	6	150	356	250	279	444	272	318	
	8	200	495	295	343	533	330	381	
	10	250	622	334	406	622	360	444	
	12	300	698	368	483	711	406	521	
	14	350	787	415	533	838	480	584	
	16	400	864	460	597	864	535	648	
	18	450	978	510	635	978	575	711	
	20	500	978	583	698	1016	630	775	
	24	600	1295	630	813	—	—	—	
BODY		SCPH2 / A216 Gr.WCB				SCPH2 / A216 Gr.WCB			
COVER		SCPH2 / A216 Gr.WCB				SCPH2 / A216 Gr.WCB			
HINGE PIN		A276 TYPE403				A276 TYPE403			
DISC		A182 Gr.F6A / A216 Gr.WCB+13Cr				A182 Gr.F6 / WCB+13Cr			

Brass & Bronze

Cast Iron

Ductile Iron

Stainless Steel

Carbon Steel

Butterfly Valve

Ball Valve

Ball Valve Seat

Actuated Valve

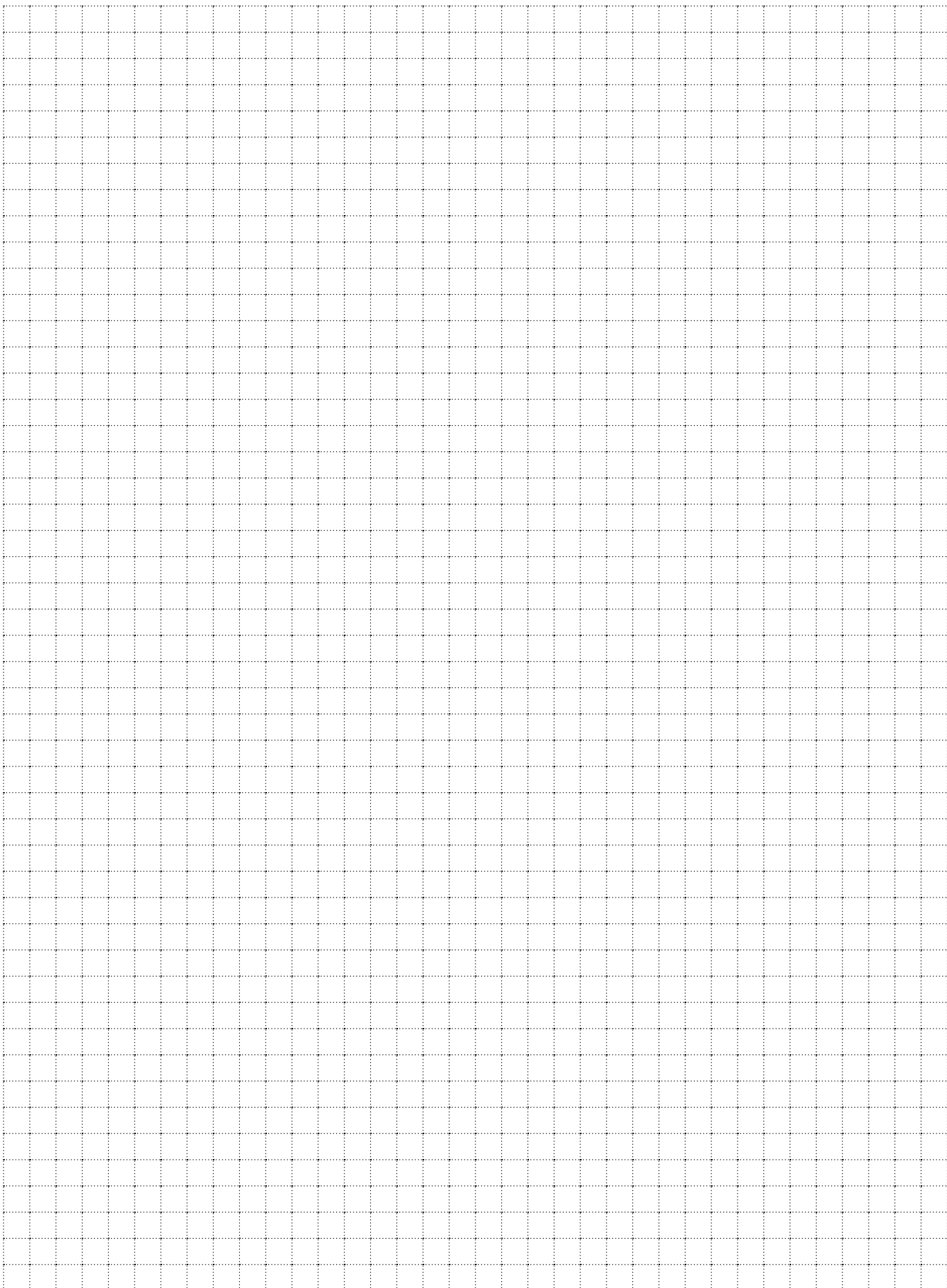

# BUTTERFLY VALVE

# Butterfly Valve

## KITZ DJ Series Butterfly Valves

Thorough pursuit of functions required for butterfly valves  
 Variety of product ranges to comply with customers' requirements

### Design Features

#### Molded-in (bonded) seat structure (Size 2 to 12)

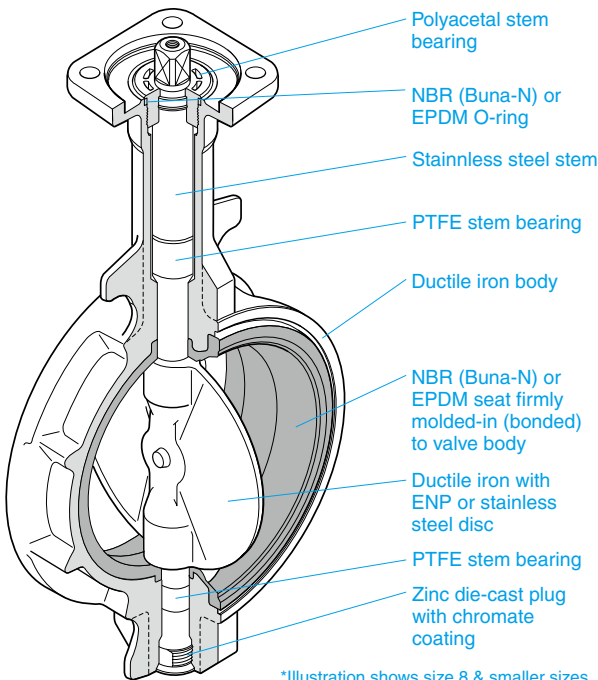

\*Illustration shows size 8 & smaller sizes

#### Replaceable seat structure (Size 14 to 24)

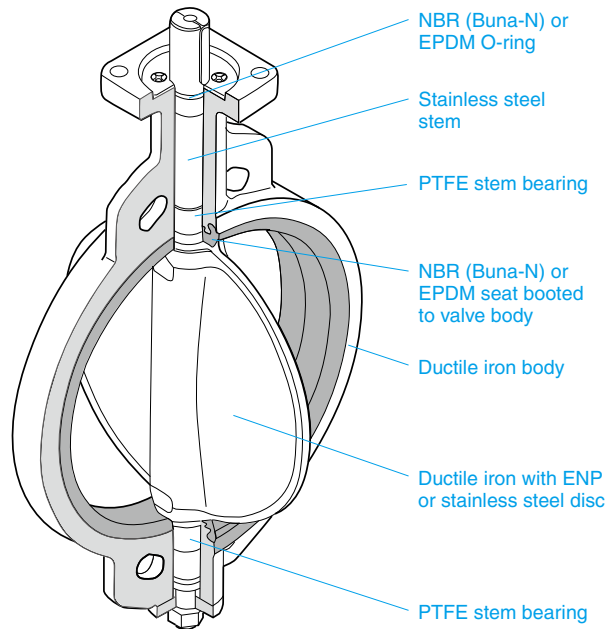

### P-T Rating

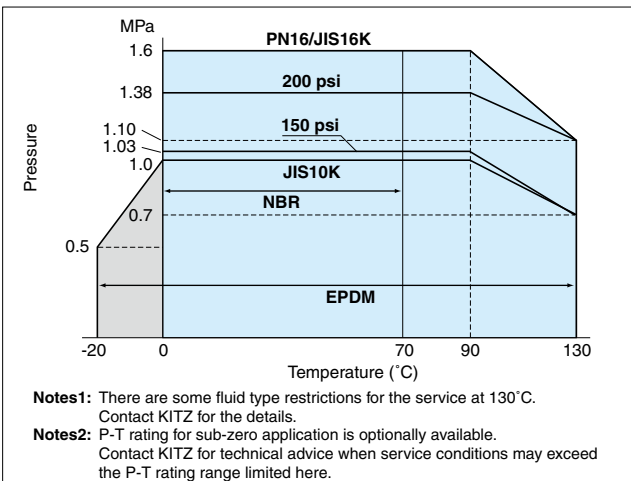

### Pressure Loss

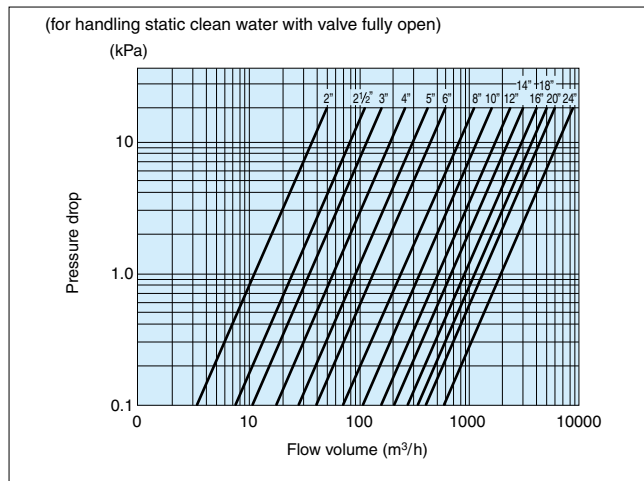



## Technical Specifications

### Maximum Service Pressure

ASME 150 psi	1.03MPa
ASME 200 psi	1.38MPa
BS PN16	1.6 MPa
JIS 10K	1.0 MPa
JIS 16K	1.6 MPa

### Body Material

Ductile iron	ASTM A536 Gr. 65-45-12 *1
--------------	---------------------------

\*1 JIS 10K design, size 14" & larger: Cast iron ASTM A126 Class B

### Service Temperature Range

NBR (Buna-N) seat	0°C to +70°C
EPDM seat	-20°C to +130°C *2
Continuous service temperature range	0°C to +100°C

\*2 There are some fluid type restrictions for the service at 130°C. Contact KITZ for the details.

### Applicable Standards

Valve design	API 609, MSS-SP 67, EN 593, JIS B 2032
Face to face dimensions	API 609 Category A, MSS-SP 67 W-1 : Size 2 to 14 W-2 : Size 16 to 24 EN 558 basic series 20, ISO 5752 20 Series, JIS B 2002 46 Series

### Coupling Flanges

Wafer type	ASME Class 125/150 EN 1092 PN 10: DN 50 to DN 350, PN 16: All Sizes BS 10 Table D/Table E JIS 10K/16K
Lugged type	ASME Class 125/150 EN 1092 PN 10: DN 50 to DN 150, PN 16: All Sizes

### Explanation of Product Code

**G - PN16 DJ L U E**

1                      2                      3                      4                      5                      6

#### 1 Valve operation

None ..... Lever handle  
**G** ..... Gear  
**VG** ..... Vertical gear  
**B** ..... Type B pneumatic actuator  
**BS** ..... Type BS pneumatic actuator  
**FA** ..... Type FA pneumatic actuator  
**FAS** ..... Type FAS pneumatic actuator  
**EXS110/200** ... Type EXS KELMO® electric actuator  
**EXD110/200** ... Type EXC KELMO® electric proportional control actuator

#### 2 Class

150..... ASME 150 psi  
 200..... ASME 200 psi  
**PN16**..... EN1092 PN 16  
 10..... JIS 10K  
 16..... JIS 16K

#### 3 Valve material and design

**DJ**..... Ductile iron DJ series  
 \*Cast iron for JIS10K, Size 350-600  
**FDDJ**..... Ductile iron for JIS10K,  
 Size 350-600 (Option)

#### 4 Connection

None..... Wafer  
**L**..... Lugged  
**F**..... Double flanged

#### 5 Disc material

None..... Ductile iron (Ni-plated)  
**U**..... 304 stainless steel  
**M**..... 316 stainless steel  
**A**..... Aluminum bronze

#### 6 Seat material

None..... NBR (Buna-N)  
**E**..... EPDM

# KITZ EJ Series Butterfly Valves

## Materials

Parts	Materials
Body	Ductile iron [EN-GJS-450-10]
Stem	Stainless Steel [AISI 410]
Disc	Stainless Steel [A351 Gr.CF8M]
Seat	W-NBR (White NBR) VMQ (Silicone rubber) FKM (Fluoro rubber)
O-ring	FKM
Bearing	Stainless Steel
Stem bearing	Multi-layered bearing*
Plug	Zinc die-cast
Bottom stem	Stainless Steel [AISI 410]

\* Tetrafluoroethylene resin filled overlayer, a sintered bronze interlayer and a steel backing.

## Flange Table

Standard		BS EN 1092			BS10	ASME B16.5
Size		PN6	PN10	PN16	Table E	Class150
inch	mm					
2	50	●	●	●	●	▲
2 1/2	65	▲	●	●	●	▲
3	80	●	●	●	●	●
4	100	●	●	●	●	●
5	125	●	▲	▲	▲	●
6	150	●	●	●	▲	●
8	200	●	●	●	▲	●
10	250	●	▲	●	▲	▲
12	300	●	▲	▲	▲	▲

● : Standard mounting  
▲ : Special mounting (Proper centering is required)

### 3 type of Seat material.

The 3 type of seat material are; VMQ(Silicone rubber) which can be used for a wide range of temperature applications, W-NBR(White NBR), which is suitable for use in the food processing industry and FKM(Fluoro rubber) which has properties such as strength and durability idea for use on variety of fluid applications. W-NBR and VMQ meet the requirement of FDA.\*

\*All the above chemical materials used are approved by FDA, and the seats are manufactured within the maximum allowable limitations and restrictions.

### Suitable for various flanges.

All the sizes are suitable for the flanges of EN1092 PN6, PN10, PN16 / BS10 Table E / ASME Class125 and Class150

## Design Features

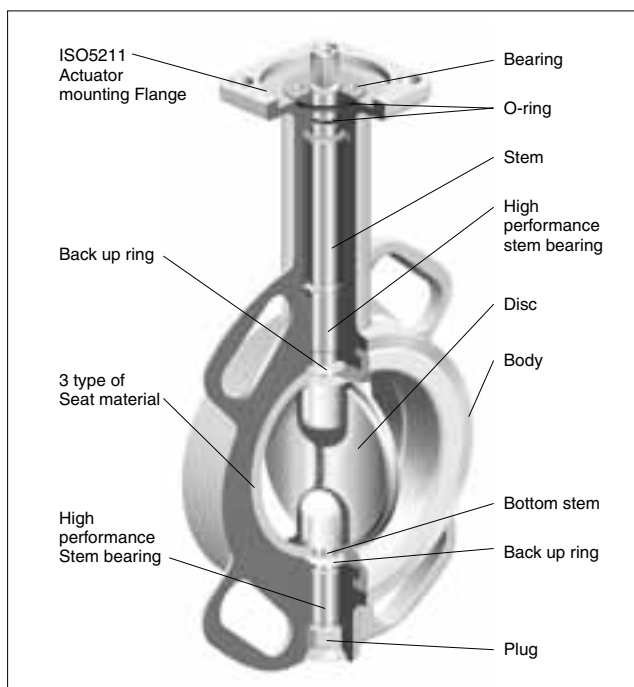

### Integral ISO 5211 actuator mounting flange.

Any pneumatic or electric valve actuator provided with ISO 5211 valve mounting flange can be easily mounted for actuation of valves in the field.

### High performance stem bearing having additional strength to withstand high temperature and high pressure.

The stem bearing of the EJ series is a multilayered backmetal to provide a high performance bearing surface capable of withstanding high pressure and temperature.

### Backup ring to maintain the stem sealing.

The backup ring around the stem maintains the performance of the stem sealing caused by the movement of the stem / disc in the sealing / seat of valve.

### Stainless steel bearing features.

Within the stainless upper body bearing is a multi-layered bearing embedded to provide smooth stem operation. Housed also within the stem bearing is a snap ring to provide protection and prevent blow out of the stem due to internal pressure.

### Polished disc.

The polished disc is standard for VMQ and optional for W-NBR seats for use within the food and pharmaceutical industry.

## Technical Specifications

### Maximum service pressure

**PN10** 10bar (1.0MPa)

### Body material

**Ductile iron** EN-GJS-450-10, Equivalent to ASTM A536 Gr. 65-45-12, BS 2789 Gr. 40/10\*1

\*1 Obsolete Standard.

### Applicable standards

**Valve design** EN 593:2004

### Coupling flanges

**Wafer type** EN1092 PN6, PN10, PN16  
BS10 Table E  
ASME Class125, Class150

## Technical Data

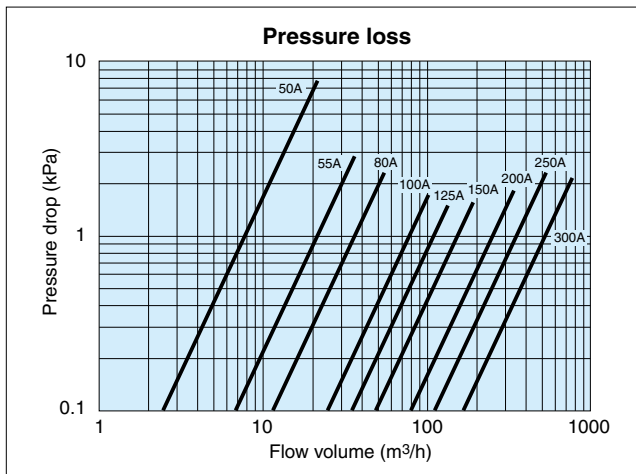

## P-T rating

### W-NBR seat

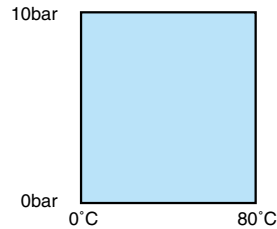

### VMQ seat

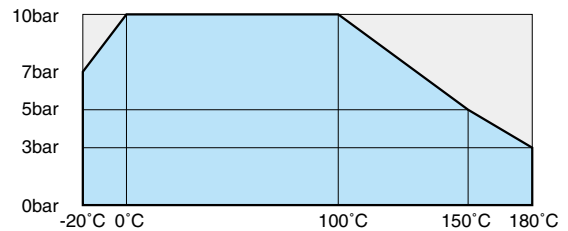

### FKM seat

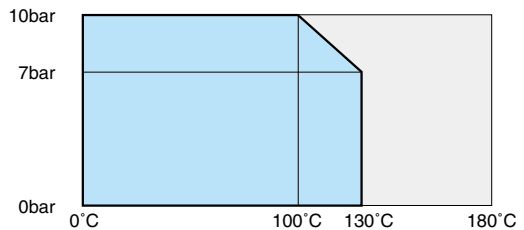

: Continuous service  
 : Occasional use (Fully open or closed position)

## Explanation of Product Code

**G – PN10 EJ M W**

1

2

3

4

5

### 1 Valve operation

None..... Lever handle  
G..... Gear

### 2 Class

PN10

### 3 Valve material and design

EJ..... Ductile iron EJ series

### 4 Disc material

M..... 316 stainless steel

### 5 Seat material

W..... W-NBR  
Q..... VMQ  
F..... FKM

Please consult KITZ sales staff or our local agent for details of the seat and the disc combination  
Please consult KITZ sales staff or our local agent for vacuum service.

## Aluminum Butterfly Valves XJ Series

KITZ XJ Series aluminum butterfly valves : Featured with unique style of the neck designs (U.S.P. No.6676109), for accommodation of various piping designs, piping positions and installation environments.

### Two neck designs for your choice :

Long neck type, short neck type are available for versatile applications.

### Easy valve-to-flange centering :

Light weight of die-cast aluminum valve body (which is only one-thirds of KITZ's conventional cast iron butterfly valves) eases valve-to-flange centering work on mounting valves on pipelines.

### Wide range of service applications :

Austenitic stainless steel discs and EPDM rubber seats can handle many different kinds of line fluid without concern of corrosion.

### Stabilized operating torque :

A pair of stem bearing assembled around the top and bottom stems prevents stem galling, and stabilizes valve operating torque for smooth and trouble-free disc rotation.

### On-the-spot actuator assembly :

The actuator mounting pads of all necks are designed in conformity with ISO 5211 requirements for direct on-site mounting of actuators which are provided with ISO 5211 valve mounting flanges.

### Prevention of dew condensation (Long neck type) :

A long stainless steel neck blocks transfer of the fluid heat to a valve operating device, which thus needs no insulation on the operating device. Dew condensation is minimized also in case of gear operated valves on cold water service.

### Rust prevention :

Main parts such as stems, discs, necks, neck connectors and endplates, and small parts such as stopper plates, washers and boltings are all made of stainless steel for highly graded rust prevention.

### S-shape spherical disc for high sealing performance (patented) :

KITZ's original cross-sectionally S-shaped valve discs with spherical surface evenly make tight contact with rubber liners for excellent sealing performance with reduced operating torque. Thorough 360° shut-off mechanism helps extend service life of rubber liners. (Size 2inch and over.)

#### Long Neck Type

Prevented dew condensation



- A long stainless steel neck reduces conductivity of the fluid heat for prevention of dew condensation.
- Availability of valve body and neck insulation.
- Choice of actuators for automated valve operation.

#### Applications:

- Building utilities .
- Piping networks for cold water, hot water and other water supply.

#### Short Neck Type

Compact design



- Suitable for piping in a limited space.
- Choice of actuators for automated valve operation.

#### Applications:

- Building utilities.
- Plant facilities.
- Water treatment service.
- Operation of industrial machineries.

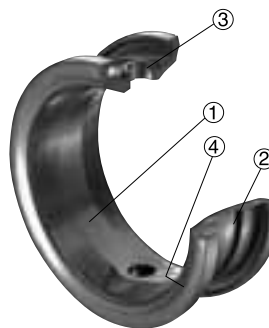

**Elaborately designed KITZ EPDM seats are featured with the following uniqueness for functional stability, high sealing performance and long life cycle:**

- Self-reinforcing back-ribs
- Wider disc seating contact
- Dual stem seal bearings

- ① Wider disc seating contact for high sealing performance.
- ② Reinforcing back-ribs to minimize valve operating problems such as distortion, skidding and exfoliation of rubber liners caused by line pressure load and friction with metal discs.
- ③ Stem seal bearings are assembled on top and bottom stems for stabilized sealing function.
- ④ Gasketless flange sealing contact for easy valve mounting.

## Technical Specification

Class	JIS 10K	Class 150	PN16
Maximum service pressure	1MPa	1MPa	1.6MPa (16bar)
Service temperature range*1	-20°C~+120°C		
Continuous service temperature range*1	0°C~+100°C		
Face-to-face dimension	API609, BS5155 (Short pattern) ISO 5752-20, JIS B 2002 46 series		
Coupling flanges	JIS B 2220 / 2239 10K	ASME Class 150 JIS B 2220 / 2239 10K	EN1092 PN16*1

\*1 Condition : Fluid is not frozen.

\*2 Refer to P-T rating chart.

\*3 With centering sleeves.

Please refer to our website ([www.kitz.co.jp](http://www.kitz.co.jp)) or contact KITZ for details.

## P-T Rating

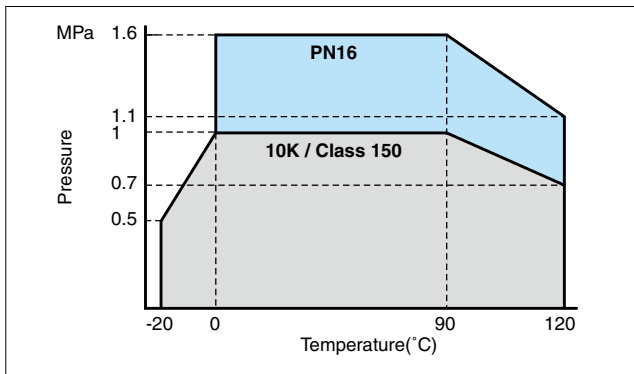

Note : Contact KITZ corporation for technical advice when service conditions may exceed the P-T rating range limited here.

## Material

Parts	Material
Body	Aluminum Die-cast / Equivalent ASTM B85-84-383.0
Neck	A351 Gr. CF8
Stem	(Equivalent ASTM A276 Type 410)
Disc	A351 Gr. CF8M
O-ring	EPDM
Rubber seat	EPDM
Bottom stem	(Equivalent ASTM A276 Type 410)
Bearing	Metal Backed PTFE (Size 10" and 12") Polyphenylenesulfide (10XJMEA : Size 1 1/2" to 8") Bronze : CAC401C (PN16XJME : Size 2" to 8")

## Pressure Loss (for handling static clean water)

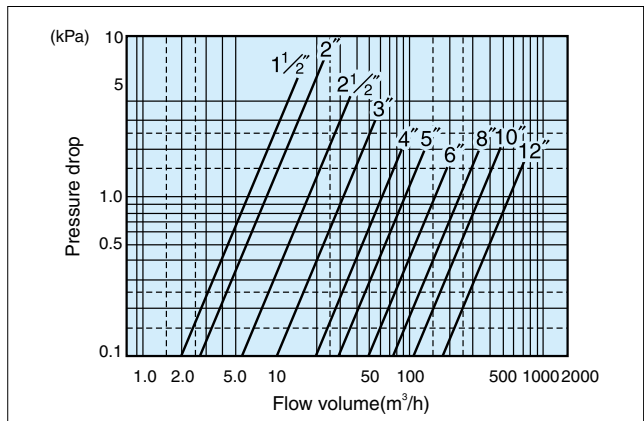

## Dew Condensation Test

Samples of KITZ XJ Series butterfly valves equipped with long necks (KITZ Product Code : G-10XJMEA) were tested at KITZ laboratory under the conditions introduced below. Lower surface temperature of gear boxes, atmospheric temperatures and atmospheric humidities were measured as the variable functions. The dew condensations boundary was estimated as illustrated below.

### Test condition :

Line fluid : +5°C cold water

Atmospheric temperature : +20°C to +40°C

Valve insulation : 50mm glass wool (JIS A 9501) around the test valve with gear boxes exposed to the open air.

### Note:

The estimation introduced here is a result of summary of the tests carried out within a test basin provided with constant temperature and humidity, and does not necessarily represent absolute values. Note that dew condensation preventative property of these valves may be affected by change of test environments such as extent of air transfer and variation of line fluid temperature, atmospheric humidity or condition of insulation. Thus, acceptance of allowance of  $\pm 5\%$  over the boundary area is recommended.

G-10XJMEA Estimated Dew Condensation Boundary

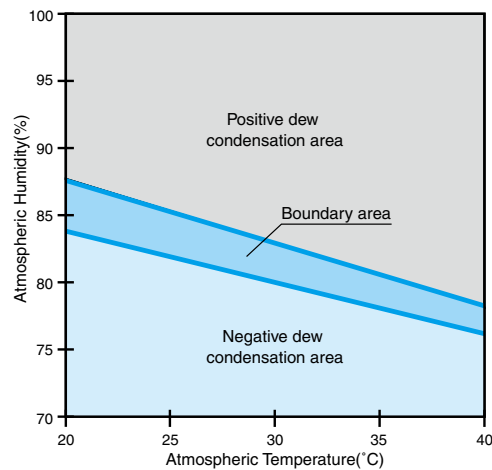

## Product Coding

### 1 Valve operation

None... Lever

G..... Gear

FA..... Pneumatic actuator(Double action)

FAS..... Pneumatic actuator  
(Spring return action)

EXS..... Electric actuator(Please consult KITZ  
for availability of power supply)

**G - 10 XJ S M E A**

1

2

3

4

5

6

2

### 2 Class

10..... JIS 10K

10...A... JIS 10K/ASME Class 150

PN16..... EN1092 4504 PN16

### 3 KITZ Butterfly valve series

XJ.....XJ series

### 4 Design

None... Long neck

S..... Short neck

### 5 Disc material

M.....316 stainless steel

### 6 Seat material

E.....EPDM

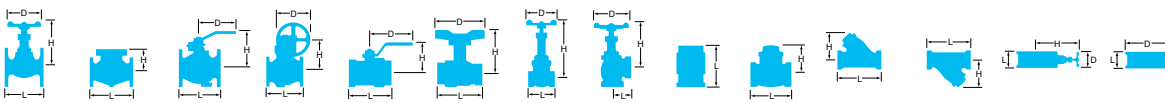

TYPE		BUTTERFLY			BUTTERFLY			BUTTERFLY			BUTTERFLY			BUTTERFLY			
Butterfly Valve																	
FIG		10XJME			G-10XJME			(PH)PN16XJME			(PH)G-PN16XJME			10DJ			
PRESSURE		10K			10K			PN16			PN16			10K			
END CONNECTION		Wafer Type (JIS 5K,10K)			Wafer Type (JIS 5K,10K)			Wafer Type (BS E1092 PN16)			Wafer Type (BS E1092 PN16)			Wafer Type (JIS 5K,10K)			
DIMENSIONS	inch	mm	L	H	D	L	H	D	L	H	D	L	H	D	L	H	D
	1 1/2	40	33	172	180	33	175	122	43	176	180	43	179	122	43	191	180
	50	50	43	176	180	43	179	122	43	176	180	43	179	122	43	191	180
	65	65	46	185	180	46	188	122	46	185	180	46	188	122	46	199	180
	80	80	46	193	180	46	196	122	46	193	180	46	212	135	46	217	180
	100	100	52	204	180	52	223	135	52	204	180	52	223	135	52	227	180
	125	125	56	249	230	56	258	150	56	249	230	56	258	150	56	265	230
	6	150	56	261	230	56	270	150	56	261	230	56	270	150	56	277	230
	8	200	-	-	-	60	311	180	-	-	-	60	311	180	-	-	-
	10	250	-	-	-	68	405	180	-	-	-	-	-	-	-	-	-
	12	300	-	-	-	78	430	180	-	-	-	-	-	-	-	-	-
	14	350	-	-	-	-	-	-	-	-	-	-	-	-	-	-	-
	16	400	-	-	-	-	-	-	-	-	-	-	-	-	-	-	-
	18	450	-	-	-	-	-	-	-	-	-	-	-	-	-	-	-
	20	500	-	-	-	-	-	-	-	-	-	-	-	-	-	-	-
	24	600	-	-	-	-	-	-	-	-	-	-	-	-	-	-	-
BODY		Aluminum Die-Cast			Aluminum Die-Cast			Aluminum Die-Cast			Aluminum Die-Cast			FCD450-10			
BONNET		-			-			-			-			-			
STEM		SUS410			SUS410			SUS410			SUS410			SUS403 / SUS410			
DISC		A276 316 / A351 CF8M			A276 316 / A351 CF8M			A276 316 / A351 CF8M			A276 316 / A351 CF8M			FCD450-10+ENP			
SEAT		EPDM			EPDM			EPDM			EPDM			NBR			
														Ductile iron (Ni-plated) disc			

TYPE		BUTTERFLY			BUTTERFLY			BUTTERFLY			BUTTERFLY			BUTTERFLY			
Butterfly Valve																	
FIG		G-10DJ			VG-10DJ			PN16DJ			G-PN16DJ			PN16DJL			
PRESSURE		10K			10K			PN16			PN16			PN16			
END CONNECTION		Wafer Type (JIS 5K,10K)			Wafer Type (JIS 5K,10K)			Wafer Type (BS E1092 PN16)			Wafer Type (BS E1092 PN16)			Lug Type (BS E1092 PN16)			
DIMENSIONS	inch	mm	L	H	D	L	H	D	L	H	D	L	H	D	L	H	D
	1 1/2	40	-	-	-	-	-	-	-	-	-	-	-	-	-	-	-
	50	50	43	194	122	43	270	110	43	191	180	43	194	80	43	191	180
	65	65	46	202	122	46	278	110	46	199	180	46	202	80	46	199	180
	80	80	46	236	135	46	285	110	46	217	180	46	236	110	46	217	180
	100	100	52	246	135	52	295	110	52	227	180	52	246	110	52	227	180
	125	125	56	274	150	56	325	170	56	265	230	56	274	110	56	265	230
	6	150	56	286	150	56	337	170	56	277	230	56	286	110	56	277	230
	8	200	60	325	180	60	404	200	60	295	350	60	325	170	60	295	350
	10	250	68	381	250	68	461	310	-	-	-	68	381	250	-	-	-
	12	300	78	406	250	78	486	310	-	-	-	78	406	250	-	-	-
	14	350	78	445	220	78	569	360	-	-	-	78	461	360	-	-	-
	16	400	102	500	220	102	624	360	-	-	-	102	516	360	-	-	-
	18	450	114	524	220	114	648	360	-	-	-	114	540	360	-	-	-
	20	500	127	589	350	127	741	500	-	-	-	127	623	500	-	-	-
	24	600	154	637	350	154	789	500	-	-	-	154	671	500	-	-	-
BODY		FCD450-10			FCD450-10			FCD450-10			FCD450-10			FCD450-10			
BONNET		-			-			-			-			-			
STEM		SUS403 / SUS410			SUS403 / SUS410			A276 TYPE 410			A276 TYPE 410			A276 TYPE 410			
DISC		FCD450-10+ENP			FCD450-10+ENP			FCD450-10+ENP			FCD450-10+ENP			FCD450-10+ENP			
SEAT		NBR			NBR			NBR			NBR			NBR			
		Ductile iron (Ni-plated) disc			Ductile iron (Ni-plated) disc			Ductile iron (Ni-plated) disc			Ductile iron (Ni-plated) disc			Ductile iron (Ni-plated) disc			

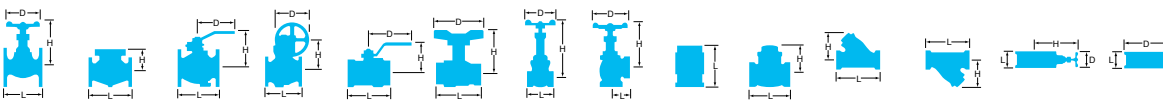

TYPE		BUTTERFLY			BUTTERFLY			BUTTERFLY			BUTTERFLY			BUTTERFLY				
Butterfly Valve																		
FIG		G-PN16DJL			PN25DJE			PN25DJLE			G-150DJ			G-150DJE				
PRESSURE		PN16			PN25			PN25			Class 150			Class 150				
END CONNECTION		Lug Type (BS E1092 PN16)			Wafer Type (BS EN1092 PN25)			Lug Type (BS E1092 PN16)			Wafer Type (ASME B16.5 CL150)			Wafer Type (ASME B16.5 CL150)				
DIMENSIONS		inch	mm	L	H	D	L	H	D	L	H	D	L	H	D	L	H	D
		2	50	43	194	80	43	191	180	43	191	180	-	-	-	-	-	-
		2 1/2	65	46	202	80	46	199	180	46	199	180	-	-	-	-	-	-
		3	80	46	236	110	46	217	180	46	217	180	-	-	-	-	-	-
		4	100	52	246	110	52	227	180	52	227	180	-	-	-	-	-	-
		5	125	56	274	110	56	265	230	56	265	230	-	-	-	-	-	-
		6	150	56	286	110	56	277	230	56	277	230	-	-	-	-	-	-
		8	200	60	325	170	-	-	-	-	-	-	-	-	-	-	-	-
		10	250	68	381	250	-	-	-	-	-	-	-	-	-	-	-	-
		12	300	78	406	250	-	-	-	-	-	-	-	-	-	-	-	-
		14	350	78	461	360	-	-	-	-	-	-	77.7	447	220	77.7	447	220
		16	400	102	516	360	-	-	-	-	-	-	101.6	502	220	101.6	502	220
		18	450	114	540	360	-	-	-	-	-	-	114.3	526	220	114.3	526	220
		20	500	127	623	500	-	-	-	-	-	-	127	587	360	127	587	360
		24	600	154	671	500	-	-	-	-	-	-	153.9	635	360	153.9	635	360
BODY		FCD450-10			EN-GJS-450-10			EN-GJS-450-10			A536			A536				
BONNET		-			-			-			-			-				
STEM		A276 TYPE 410 / 420			AISI 410			AISI 410			A276 Type410			A276 Type410				
DISC		FCD450-10+ENP			EN-GJS-450-10(PLATED)			EN-GJS-450-10(PLATED)			FCD450-10+ENP			FCD450-10+ENP				
SEAT		NBR			EPDM			EPDM			NBR			EPDM				
		Ductile iron (Ni-plated) disc			Ductile iron (Ni-plated) disc			Ductile iron (Ni-plated) disc			Ductile iron (Ni-plated) disc			Ductile iron (Ni-plated) disc				

TYPE		BUTTERFLY			BUTTERFLY			BUTTERFLY			BUTTERFLY			BUTTERFLY				
Butterfly Valve																		
FIG		G-150DJL			200DJ			200DJL			G-200DJ			G-200DJE				
PRESSURE		Class 150			Class 200			Class 200			Class 200			Class 200				
END CONNECTION		Lug Type (ASME B16.5 CL150)			Wafer Type (ASME B16.5 CL150)			Lug Type (ASME B16.5 CL150)			Wafer Type (ASME B16.5 CL150)			Wafer Type (ASME B16.5 CL150)				
DIMENSIONS		inch	mm	L	H	D	L	H	D	L	H	D	L	H	D	L	H	D
		2	50	-	-	-	42.9	191	180	42.9	191	180	42.9	194	121.5	42.9	194	121.5
		2 1/2	65	-	-	-	46	199	180	46	199	180	46	202	121.5	46	202	121.5
		3	80	-	-	-	46	217	180	46	217	180	46	236	135	46	236	135
		4	100	-	-	-	52.3	227	180	52.3	227	180	52.3	246	135	52.3	246	135
		5	125	-	-	-	55.6	265	230	55.6	265	230	55.6	274	150	55.6	274	150
		6	150	-	-	-	55.6	277	230	55.6	277	230	55.6	286	150	55.6	286	150
		8	200	-	-	-	60.5	295	350	60.5	295	350	60.5	325	180	60.5	325	180
		10	250	-	-	-	-	-	-	-	-	-	68.3	381	180	68.3	381	180
		12	300	-	-	-	-	-	-	-	-	-	77.7	406	180	77.7	406	180
		14	350	77.7	447	220	-	-	-	-	-	-	-	-	-	-	-	-
		16	400	101.6	502	220	-	-	-	-	-	-	-	-	-	-	-	-
		18	450	114.3	526	220	-	-	-	-	-	-	-	-	-	-	-	-
		20	500	127	587	360	-	-	-	-	-	-	-	-	-	-	-	-
		24	600	153.9	635	360	-	-	-	-	-	-	-	-	-	-	-	-
BODY		A536			A536			A536			A536			A536				
BONNET		-			-			-			-			-				
STEM		A276 Type410			A276 Type410			A276 Type410			A276 Type410			A276 Type410				
DISC		FCD450-10+ENP			FCD450-10+ENP			FCD450-10+ENP			FCD450-10+ENP			FCD450-10+ENP				
SEAT		NBR			NBR			NBR			NBR			EPDM				
		Ductile iron (Ni-plated) disc			Ductile iron (Ni-plated) disc			Ductile iron (Ni-plated) disc			Ductile iron (Ni-plated) disc			Ductile iron (Ni-plated) disc				

Brass & Bronze  
Cast Iron  
Ductile Iron  
Stainless Steel  
Carbon Steel  
Butterfly Valve  
Ball Valve  
Ball Valve Seat  
Actuated Valve

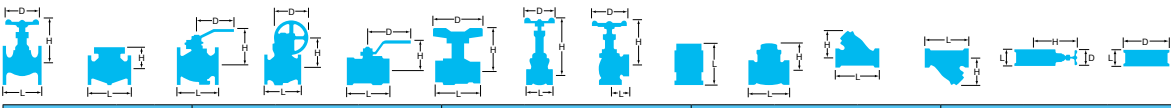

TYPE			BUTTERFLY			BUTTERFLY			BUTTERFLY			BUTTERFLY			BUTTERFLY		
Butterfly Valve																	
FIG			G-200DJL			G-200DJLE			250DJ			G-250DJ			G-250DJE		
PRESSURE			Class 200			Class 200			Class 200			Class 200			Class 200		
END CONNECTION			Lug Type (ASME B16.5 CL150)			Lug Type (ASME B16.5 CL150)			Wafer Type (ASME B16.5 CL150)			Wafer Type (ASME B16.5 CL150)			Wafer Type (ASME B16.5 CL150)		
DIMENSIONS	inch	mm	L	H	D	L	H	D	L	H	D	L	H	D	L	H	D
2	50	127	42.9	194	121.5	42.9	194	121.5	42.9	191	180	42.9	194	121.5	42.9	194	121.5
2½	65	165	46	202	121.5	46	202	121.5	46	199	180	46	202	121.5	46	202	121.5
3	80	203	46	236	135	46	236	135	46	217	180	46	236	135	46	236	135
4	100	254	52.3	246	135	52.3	246	135	52.3	227	180	52.3	246	135	52.3	246	135
5	125	318	55.6	274	150	55.6	274	150	55.6	265	230	55.6	274	150	55.6	274	150
6	150	381	55.6	286	150	55.6	286	150	55.6	277	230	55.6	286	150	55.6	286	150
8	200	508	60.5	325	180	60.5	325	180	60.5	295	350	60.5	325	180	60.5	325	180
10	250	635	68.3	381	180	68.3	381	180	—	—	—	68.3	381	180	68.3	381	180
12	300	762	77.7	406	180	77.7	406	180	—	—	—	77.7	406	250	77.7	406	250
BODY			A536			A536			A536			A536			A536		
BONNET			—			—			—			—			—		
STEM			A276 Type410			A276 Type410			A276 Type410			A276 Type410			A276 Type410		
DISC			FCD450-10+ENP			FCD450-10+ENP			FCD450-10+ENP			FCD450-10+ENP			FCD450-10+ENP		
SEAT			NBR			NBR			NBR			NBR			EPDM		
			Ductile iron (Ni-plated) disc			Ductile iron (Ni-plated) disc			Ductile iron (Ni-plated) disc			Ductile iron (Ni-plated) disc			Ductile iron (Ni-plated) disc		

TYPE			BUTTERFLY			BUTTERFLY			BUTTERFLY			BUTTERFLY			BUTTERFLY		
Butterfly Valve																	
FIG			250DJL			G-250DJL			G-250DJLE			G-250DJA			G-250DJA E		
PRESSURE			Class 200			Class 200			Class 250			Class 250			Class 250		
END CONNECTION			Lug Type (ASME B16.5 CL150)			Lug Type (ASME B16.5 CL150)			Lug Type (ASME B16.5 CL150)			Wafer Type (ASME B 16.5 CL150)			Wafer Type (ASME B 16.5 CL150)		
DIMENSIONS	inch	mm	L	H	D	L	H	D	L	H	D	L	H	D	L	H	D
2	50	127	42.9	191	180	42.9	194	121.5	42.9	194	121.5	42.9	194	121.5	42.9	194	121.5
2½	65	165	46	199	180	46	202	121.5	46	202	121.5	46	202	121.5	46	202	121.5
3	80	203	46	217	180	46	236	135	46	236	135	46	236	135	46	236	135
4	100	254	52.3	227	180	52.3	246	135	52.3	246	135	52.3	246	135	52.3	246	135
5	125	318	55.6	265	230	55.6	274	150	55.6	274	150	55.6	274	150	55.6	274	150
6	150	381	55.6	277	230	55.6	286	150	55.6	286	150	55.6	286	150	55.6	286	150
8	200	508	60.5	295	350	60.5	325	180	60.5	325	180	60.5	325	180	60.5	325	180
10	250	635	—	—	—	68.3	381	250	68.3	381	250	68.3	381	250	68.3	381	250
12	300	762	—	—	—	77.7	406	250	77.7	406	250	77.7	406	250	77.7	406	250
BODY			A536			A536			A536			A536			A536		
BONNET			—			—			—			—			—		
STEM			A276 Type410			A276 Type410			A276 Type410			A276 Type410			A276 Type410		
DISC			FCD450-10+ENP			FCD450-10+ENP			FCD450-10+ENP			Aluminum-Bronze			Aluminum-Bronze		
SEAT			NBR			NBR			EPDM			NBR			EPDM		
			Ductile iron (Ni-plated) disc			Ductile iron (Ni-plated) disc			Ductile iron (Ni-plated) disc								



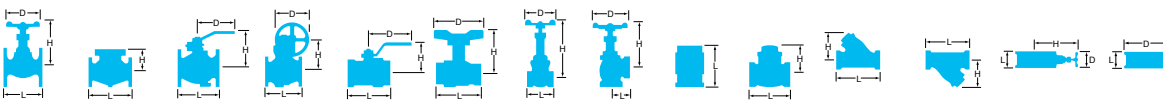

TYPE		BUTTERFLY			BUTTERFLY			BUTTERFLY			BUTTERFLY			BUTTERFLY				
Butterfly Valve																		
FIG		G-250DJLA			G-250DJLAE			10UB			GL-10UB			GL-150UB				
PRESSURE		Class 250			Class 250			10K			10K			Class 150				
END CONNECTION		Lug Type (ASME B16.5 CL150)			Lug Type (ASME B16.5 CL150)			Wafer Type			Wafer Type			Wafer Type				
DIMENSIONS		inch	mm	L	H	D	L	H	D	L	H	D	L	H	D	L	H	D
	2	50	42.9	194	121.5	42.9	194	121.5	43	176	230	43	192	150	43	192	150	
	2 1/2	65	46	202	121.5	46	202	121.5	46	186	230	46	202	150	46	202	150	
	3	80	46	236	135	46	236	135	46	207	280	46	226	195	46	226	195	
	4	100	52.3	246	135	52.3	246	135	52	221	280	52	240	195	52	240	195	
	5	125	55.6	274	150	55.6	274	150	56	241	350	56	261	204	56	261	204	
	6	150	55.6	286	150	55.6	286	150	56	263	350	56	283	204	56	283	204	
	8	200	60.5	325	180	60.5	325	180	-	-	-	71	348	280	71	348	280	
	10	250	68.3	381	250	68.3	381	250	-	-	-	76	416	310	-	-	-	
	12	300	77.7	406	250	77.7	406	250	-	-	-	83	443	310	-	-	-	
	14	350	-	-	-	-	-	-	-	-	-	92	476	358	-	-	-	
	16	400	-	-	-	-	-	-	-	-	-	102	572	360	-	-	-	
	18	450	-	-	-	-	-	-	-	-	-	114	607	360	-	-	-	
20	500	-	-	-	-	-	-	-	-	-	127	623	360	-	-	-		
24	600	-	-	-	-	-	-	-	-	-	154	757	377	-	-	-		
BODY		A536			A536			SCS13A			SCS13A			A351 GR.CF8				
BONNET		-			-			-			-			-				
STEM		A276 Type410			A276 Type410			SUS304			SUS304			SUS304 N2				
DISC		Aluminum-Bronze			Aluminum-Bronze			SCS13A			SCS13A			A351 GR. CF8				
SEAT		NBR			EPDM			PTFE			PTFE			PTFE				

TYPE		BUTTERFLY			BUTTERFLY			BUTTERFLY			BUTTERFLY			DAMPER				
Butterfly Valve																		
FIG		10NFJNE			G-10NFJNE			10NFJNW			G-10NFJNW			10D				
PRESSURE		10K			10K			10K			10K			10K				
END CONNECTION		Wafer Type (JIS 5K,10K)			Wafer Type (JIS 5K,10K)			Wafer Type (JIS 5K,10K)			Wafer Type (JIS 5K,10K)			Wafer Type				
DIMENSIONS		inch	mm	L	H	D	L	H	D	L	H	D	L	H	D	L	H	D
	2	50	43	176	180	43	179	122	43	176	180	43	179	122	40	183	200	
	2 1/2	65	46	184	180	46	187	122	46	184	180	46	187	122	45	191	200	
	3	80	46	194	180	46	213	135	46	194	180	46	213	135	50	198	200	
	4	100	52	204	180	52	223	135	52	204	180	52	223	135	60	208	200	
	5	125	56	249	230	56	258	150	56	249	230	56	258	150	65	237	280	
	6	150	56	261	230	56	270	150	56	261	230	56	270	150	70	247	280	
	8	200	-	-	-	60	311	180	-	-	-	60	311	180	80	272	280	
	10	250	-	-	-	68	381	250	-	-	-	68	381	250	90	340	350	
12	300	-	-	-	78	406	250	-	-	-	78	406	250	100	365	350		
BODY		FCD450-10			FCD450-10			FCD450-10			FCD450-10			FCD250+HCr				
BONNET		-			-			-			-			-				
STEM		SUS410			SUS410			SUS410			SUS410			SUS403				
DISC		FCD450-10+Nyron11			FCD450-10+Nyron11			FCD450-10+Nyron11			FCD450-10+Nyron11			SUS430				
SEAT		EPDM			EPDM			White-NBR			White-NBR			-				
		Nylon Corted disc			Nylon Corted disc			Nylon Corted disc			Nylon Corted disc							

Brass & Bronze

Cast Iron

Ductile Iron

Stainless Steel

Carbon Steel

Butterfly Valve

Ball Valve

Ball Valve Seat

Actuated Valve

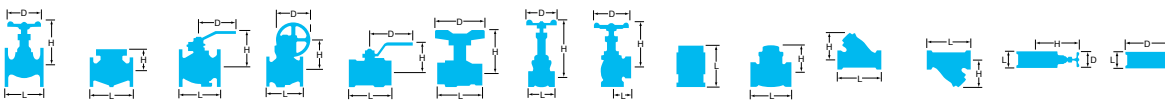

TYPE		DAMPER			DAMPER			BUTTERFLY			BUTTERFLY			
Butterfly Valve														
FIG		GL-10D			GL-10A			UV			FV			
PRESSURE		10K			10K			Class 175			Class 175			
END CONNECTION		Wafer Type			Wafer Type			BS21 (JIS B0203)			BS21 (JIS B0203)			
DIMENSIONS	inch	mm	L	H	D	L	H	D	L	H	D	L	H	D
	1/2	15	-	-	-	-	-	-	43	45	85	47	45	85
	3/4	20	-	-	-	-	-	-	47	47	85	51	47	85
	1	25	-	-	-	-	-	-	56	50	85	58	50	85
	1 1/4	32	-	-	-	-	-	-	63	60	110	67	60	110
	1 1/2	40	-	-	-	-	-	-	69	64	110	73	64	110
	2	50	40	198	150	40	198	150	77	70	110	82	70	110
	2 1/2	65	45	206	150	45	206	150	-	-	-	-	-	-
	3	80	50	213	150	50	213	150	-	-	-	-	-	-
	4	100	60	223	150	60	223	150	-	-	-	-	-	-
	5	125	65	249	190	65	249	190	-	-	-	-	-	-
	6	150	70	259	190	70	259	190	-	-	-	-	-	-
	8	200	80	284	190	80	284	190	-	-	-	-	-	-
	10	250	90	355	195	90	355	195	-	-	-	-	-	-
	12	300	100	380	195	100	380	195	-	-	-	-	-	-
BODY		FCD250+HCr			FCD250+HCr			SCS13A			Forged Brass			
BONNET		-			-			-			-			
STEM		SUS403			SUS403			SUS304			SUS304			
DISC		SUS430			SUS430			SUS304+W-NBR			SUS304+W-NBR			
SEAT		-			-			NBR			NBR			

# BALL VALVE

# Ball Valve

## KITZ Steel Ball Valves Floating Ball Design

### Design and Inspection Standards of KITZ Flanged Ball Valves

Item		American Standards	British Standards
Pressure-temperature ratings	Body	ASME B16.34	BS 5351
	Resilient sealing parts	KITZ Standard	
Shell wall thickness		ASME B16.34	BS 5351
Face-to-face dimensions		ASME B16.10	BS 2080*1
End flange dimensions and flange gasket facing		ASME B16.5	BS 1560
Pressure test		API 598 or API 6D*2	BS 6755 Part 1*2
Fire test		API 607 and API 6FA	BS 6755 Part 2

\*1 Option for 2 to 4 Class 150 full port design.

\*2 Option.

### Explanation of Product Coding

#### Example:

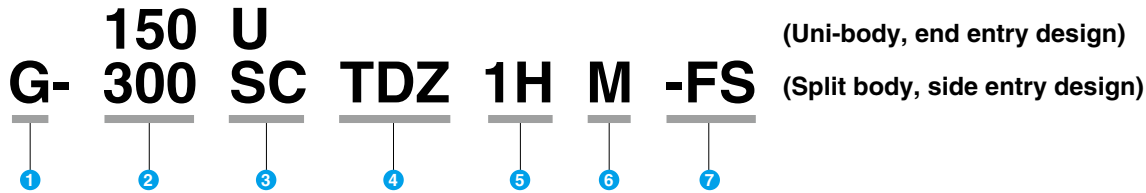

#### 1 Valve operation measure

- None ..... Lever handle
- G ..... Worm gear
- B ..... KITZ Type B double action pneumatic actuator
- BS ..... KITZ Type BS Spring return pneumatic actuator
- BSW ..... KITZ Type BSW Spring return pneumatic actuator with manual operation device
- FA ..... KITZ Type FA double action pneumatic actuator
- FAS ..... KITZ Type FAS spring return pneumatic actuator
- HAS ..... KITZ Type HAS Spring return pneumatic actuator
- E ..... Electric actuator

#### 2 ASME pressure class

150, 300, 600 or 1500

#### 3 & 6 Shell material & Trim material

- U: Symbol of stainless or high alloy steel
- SC: Symbol of carbon or low alloy steel
- U/None ..... CF8      U/CN ..... CN7M
- U/M ..... CF8M      U/HB ..... N-12MV
- U/V ..... CF3      U/HC ..... CW-12MW
- U/O ..... CF3M      SC/None/None\* ... WCB/CF8
- U/CB ..... CF8C      SC/None/M\* ..... WCB/CF8M
- U/CG ..... CG8M      SC/CL/None\* ..... LCC/CF8
- U/CK ..... CK20      SC/CL/M\* ..... LCC/CF8M
- U/SD ..... CD3MWCuN

#### 4 Valve design & type

- TDZ ..... Type TDZ
- TDZX ..... Extended stem, Type TDZ
- TB ..... Type TB
- TR ..... Type TR
- TBP ..... Pocketless, Type TB
- TB2L ..... 3-way 2-seat, L-port, Type TB
- TB2T ..... 3-way 2-seat, T-port, Type TB
- TB4LA ..... 3-way 4-seat, L-port, Type TB
- TB4TA ..... 3-way 4-seat, T-port, Type TB
- TBT ..... Direct routing to tank bottom
- TBJ ..... Jacketed, Type TB
- TBLN ..... PFA lined, Type TB
- TA ..... Type TA
- TAZ ..... Modified Type TA

#### 5 Seat Material

- None ..... HYPATITE® PTFE
- 1H\*\* ..... FILLTITE®
- 3H\*\* ..... Hard graphite seat for low abrasion service, 500°C
- 5H\*\* ..... Metal seat for abrasive service, 300°C
- 6H\*\* ..... Metal seat for high abrasive service, 500°C
- \*\* Type TDZ only

#### 6 See 3

#### 7 No symbol suffixed for PTFE packing and gasket.

"FS" or "S" suffixed for flexible graphite packing and gasket for super-firesafe provision

This catalog uses MPa, a SI unit, for indication of pressures. psi and kgf/cm<sup>2</sup> are also added for readers convenience.

## KITZ 150/300 SCTDZ/UTDZM Series Full Bore, Split Body, Side Entry Ball Valves

This is an illustrated cross-section of a typical KITZ split body floating type full bore ball valve to exhibit the basic design concept. The actual design of a valve may be slightly different from this illustration, depending on its size and pressure class.

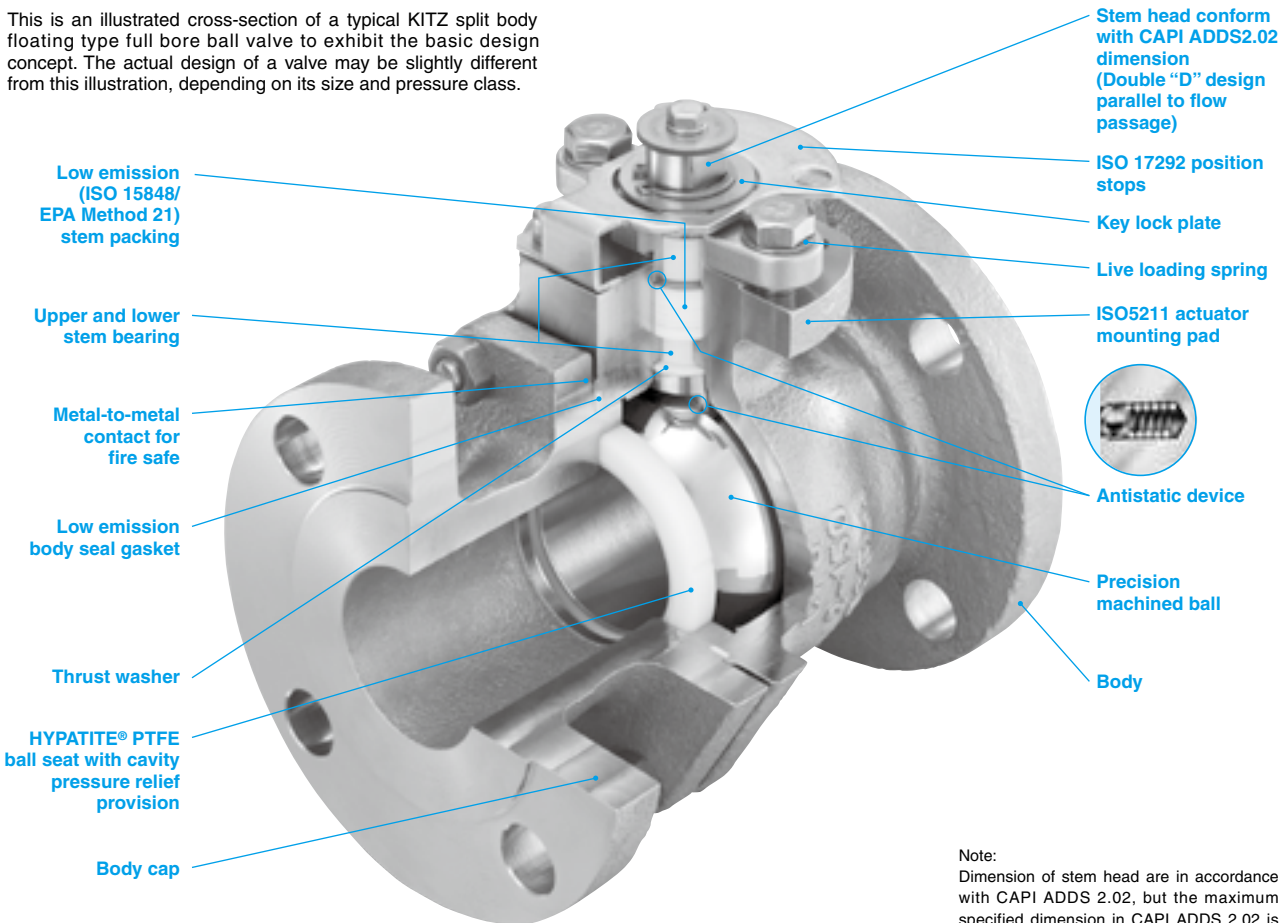

2" KITZ 150UTDZ

Note:  
Dimension of stem head are in accordance with CAPI ADDS 2.02, but the maximum specified dimension in CAPI ADDS 2.02 is "F14"  
For NPS 8 and 10, mounting pads are F16/ISO 5211.

### Bubble-tight sealing performance with HYPATITE® PTFE ball seats

HYPATITE® PTFE ball seats, standard stem seals of KITZ ball valves, are made of denatured PTFE, a molecularly reinforced PTFE copolymer, and specifically engineered for high **bi-directional** sealing performance and prolonged service life of valves. Its resistance to high or low temperature, creep or compression, abrasion and corrosion is all outstanding. As an option, KITZ **SWELLESS®** ball seats principally made of PFA are recommended specifically for monomer service. This epoch-making new seat maximizes resistance to the permeation of monomer into its molecular structure (generally known as a "swelling" problem) which causes seat deformation and seriously affects shut-off function of valves in styrene and butadiene monomer service.

### Simplified actuator mounting

For 150/300 SCTDZ/UTDZM and SCTAZ/UTAZ Series ball valves, ISO 5211 actuator mounting pad is integrally provided for uniformly simplified mounting of any actuators provided with valve mounting flanges designed to ISO 5211 dimensional requirement. 150UTBM Series ball valves are provided with KITZ standard integral actuator mounting pad.

### Easy maintenance

Split body design for KITZ SCTDZ/UTDZM Series provides the convenience of very easy maintenance critically required for process plants. Body inserts of uni-body, end entry design for KITZ 150/300 SCTDZ/UTDZ Series are threaded into the valve body with provision of unthreading for valve disassembly in case of maintenance operation.

# Ball Valve

## Pressure-Temperature Ratings

150/300 UTDZM/SCTDZ: 1/2", 3/4"

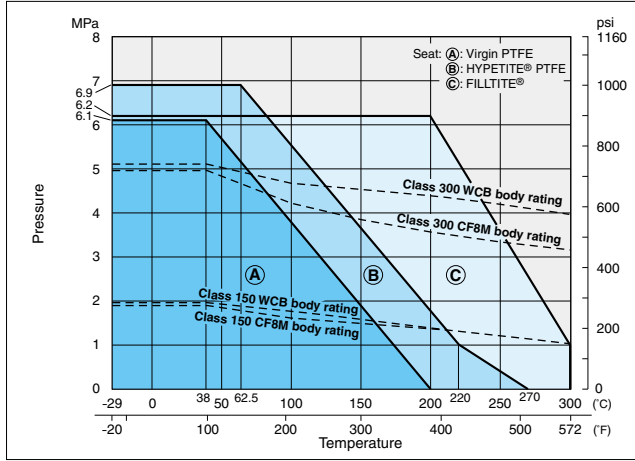

150/300 UTDZM/SCTDZ: 1" to 2 1/2"

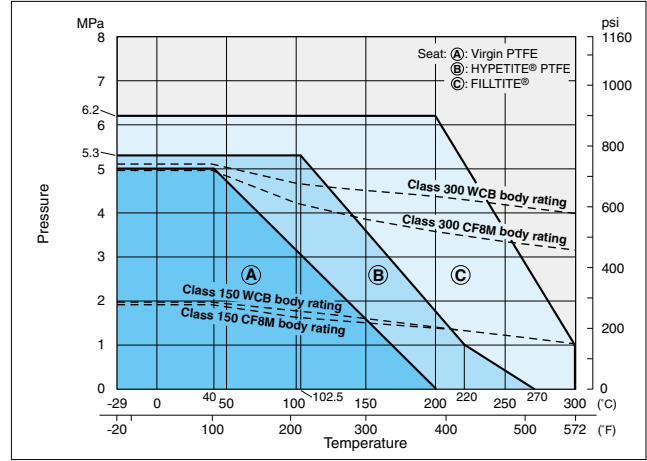

150/300 UTDZM/SCTDZ: 3", 4"

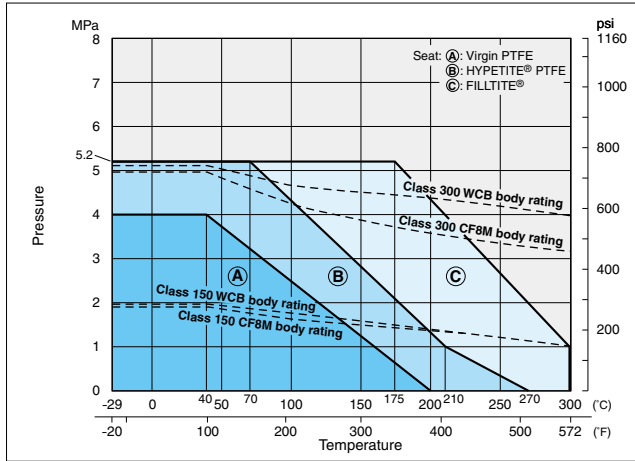

150/300 UTDZM/SCTDZ: 5", 6"

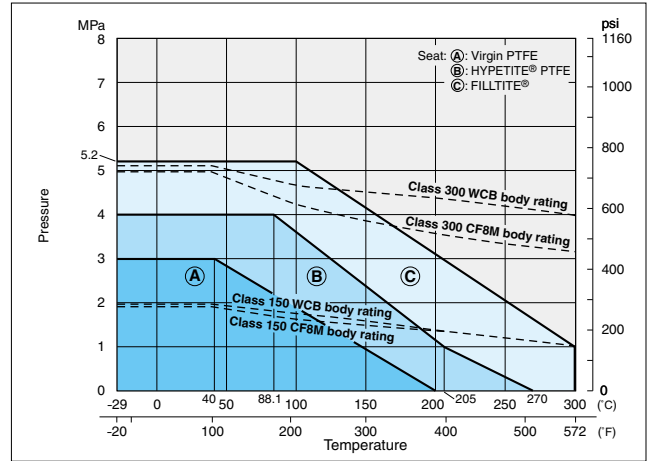

150/300 UTDZM/SCTDZ: 8", 10"

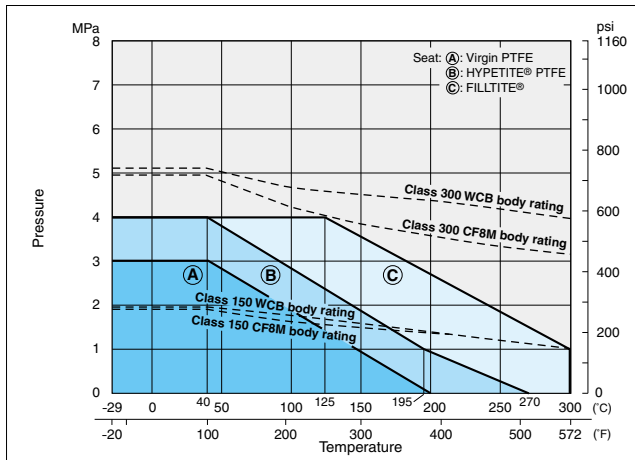

Bronze & Brass  
 Cast Iron  
 Ductile Iron  
 Stainless Steel  
 Carbon Steel  
 Butterfly Valve  
 Ball Valve  
 Ball Valve Seat  
 Actuated Valve

## Pressure-Temperature Ratings

150 UTBM : 1/2" & 3/4"\*

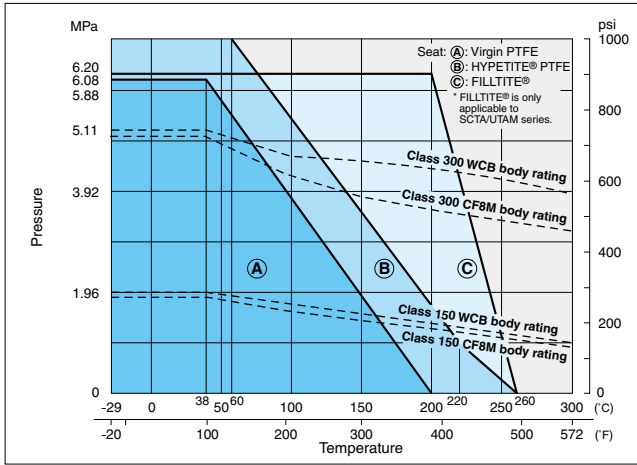

150 UTBM : 1" to 2 1/2"\*

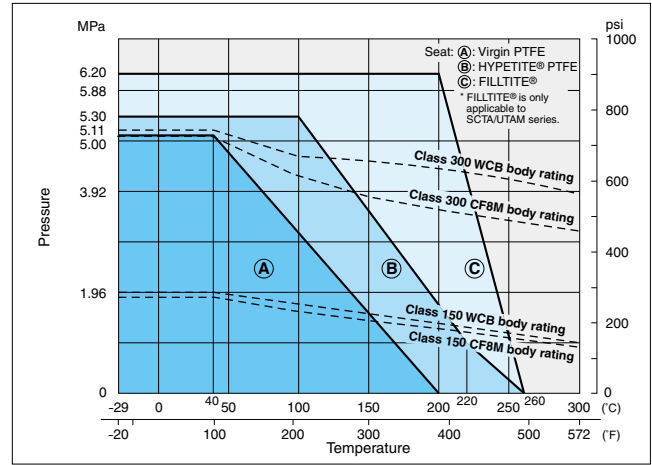

150 UTBM : 3" & 4"\*

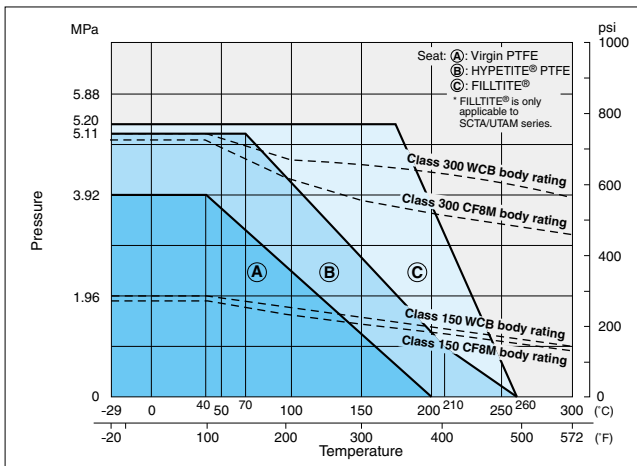

150 UTBM : 5" & 6"\*

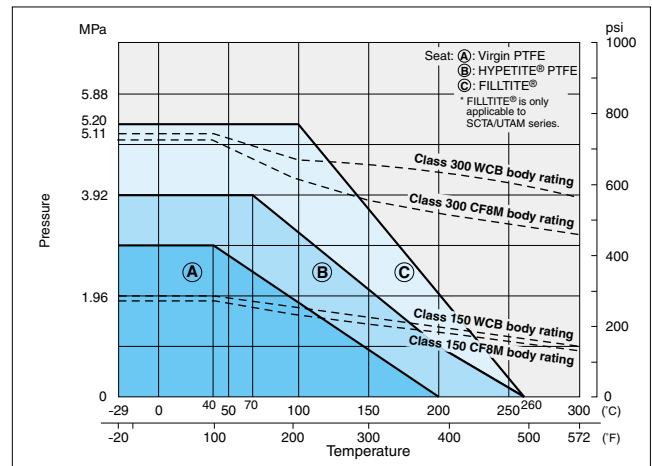

150 UTBM : 8" & 10"

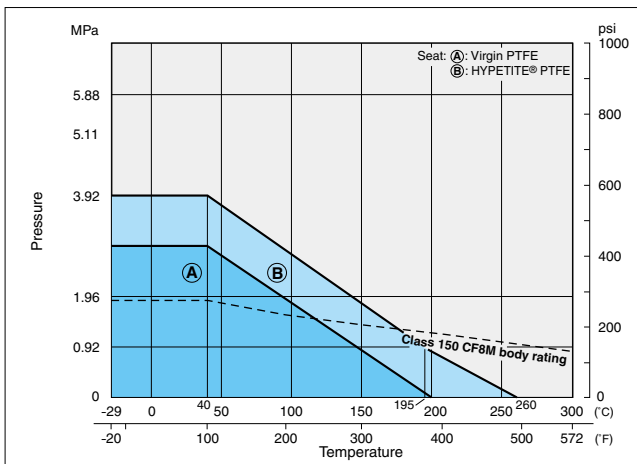

# Ball Valve

## Pressure-Temperature Ratings

### 600/1500 SCTB/UTBM

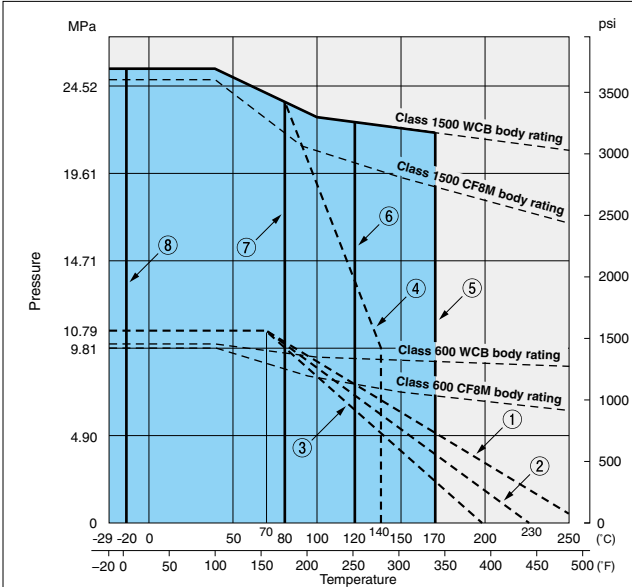

#### Ball Seat Materials

- ①: Carbon-filled PTFE
- ②: KITZ HYPATITE® or Glass-filled PTFE with MoS<sub>2</sub>
- ③: Virgin PTFE
- ④: Nylon with MoS<sub>2</sub>

#### O-ring Upper Limit

- ⑤: (1) FKM  
(2) Low-temperature FKM
- ⑥: (1) EPDM  
(2) ECO (Epichlorohydrin Copolymer)
- ⑦: (1) NBR  
(2) Low-temperature NBR

#### O-ring Lower Limit

- ⑧: FKM
- \* O-rings made of others than FKM can withstand -29°C (-20°F)

### 3-way: 150UTB4LAM/4TAM

\*Refer to 150UTBM ratings for 150UTB2LM/2TM

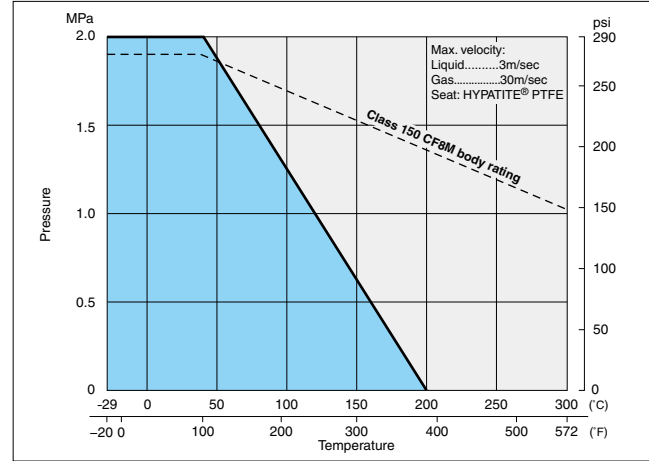

### PFA Lined: 10UTBLN

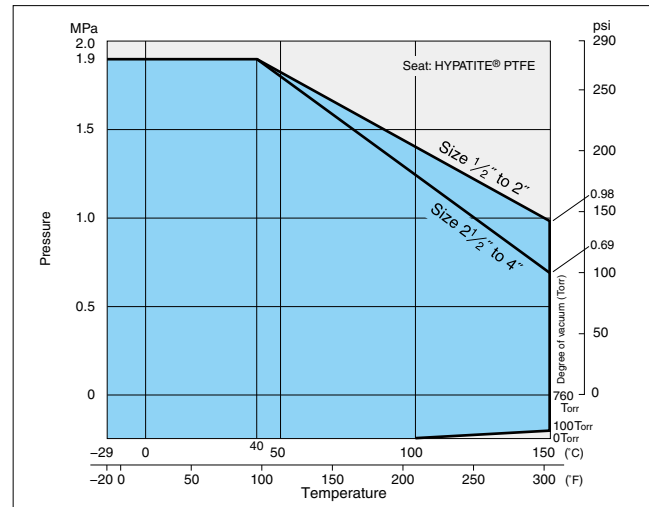

### 150/300 UTDZXL

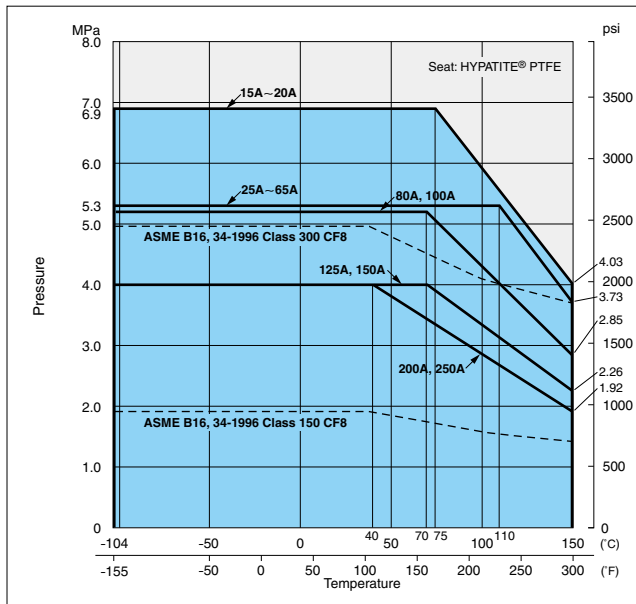



## Pressure-Temperature Ratings

**Type 600: SCK/UTKM**

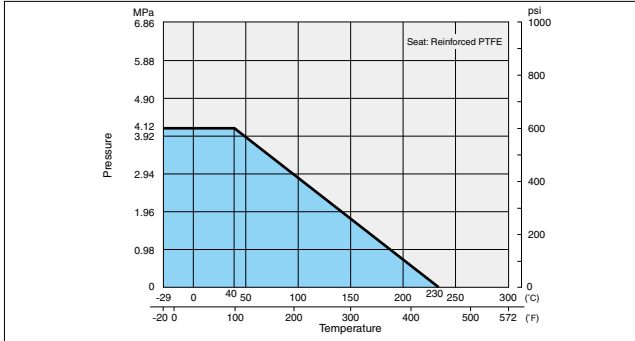

**Type 1000: UTFM**

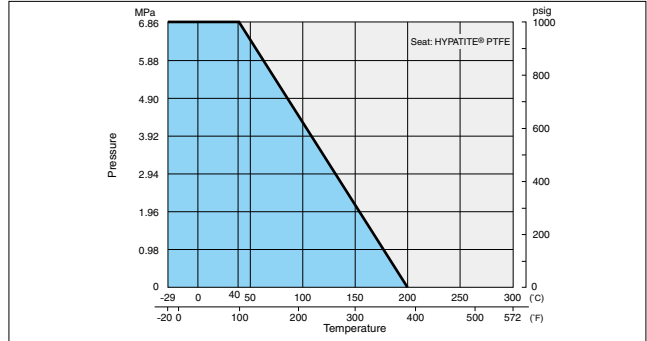

**Type 800: UTHM**

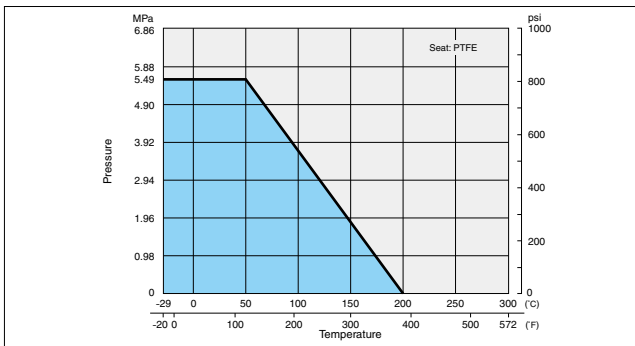

**Class 800 and Type 3000: SCK**

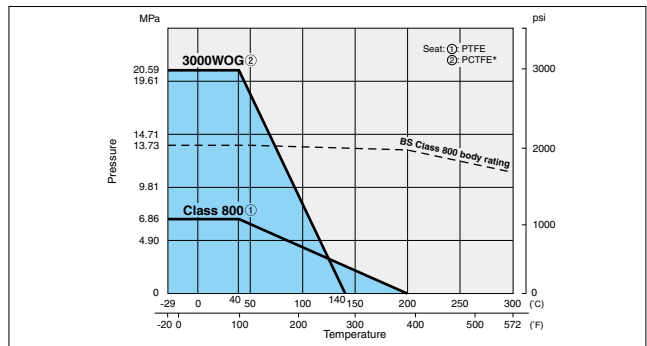

\* Polychloro-Trifluoro-Ethylene

**Type 800: UTH4LM/4TM**

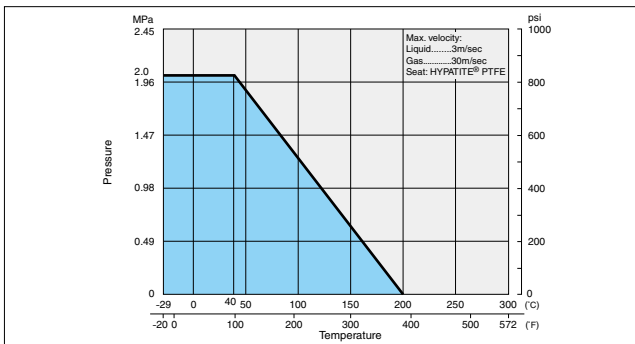

**Type 1000: SC3TZ/U3TZ Series**

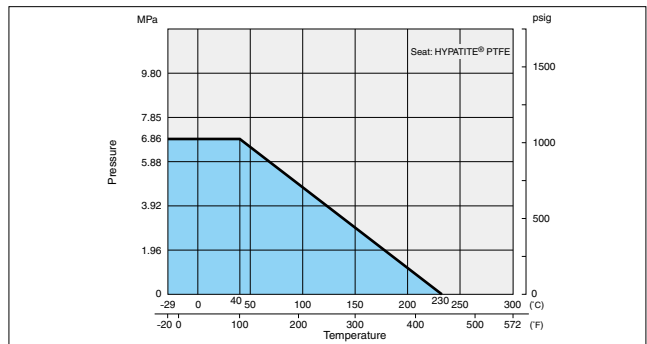

Note: Type 1500 is optionally available

**Type 1500/2000: AKSCTHZM/AKSCTHWZM/AKUTHZM/AKUTHWZM**

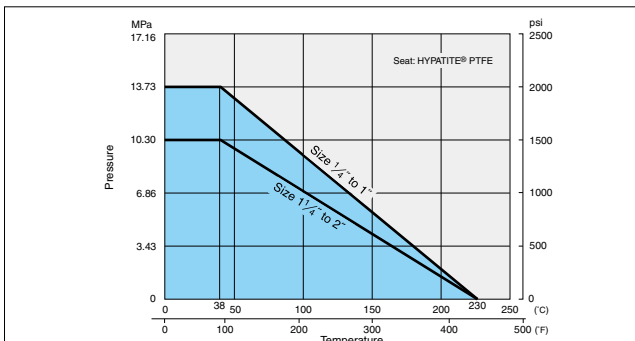

**Class 150: AK150TM**

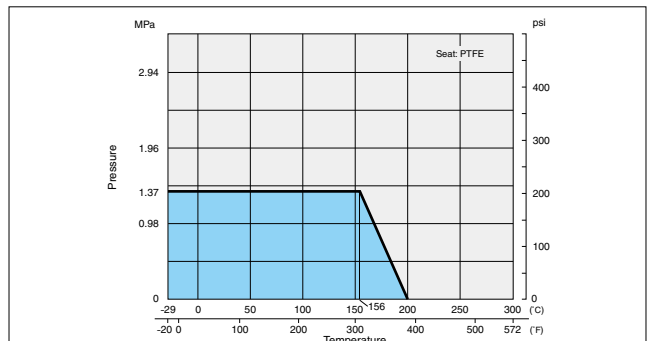

**Ball Valve**

# KITZ Steel Ball Valves for High Temperature

## Design Feature Trim 3H,5H,6H

### Split Body, Side Entry, Full Bore Design

This is an illustrated cross-section of a typical KITZ high performance ball valve to exhibit the basic design concept. The actual design of a valve may be slightly different from this illustration, depending on its size and pressure class.

Stem head conform with CAPI ADDS2.02 dimension  
(Double "D" design parallel to flow passage)

Flexible graphite  
Low emission(ISO 15848/EPA Method 21)  
stem packing

Upper and lower  
carbon stem bearing

Blowout-proof stem collar

Locking hole

Integral actuator  
mounting pad  
(ISO 5211, CAPI ADDS2.02)

Trim 3H: 304 (or 316) ball  
Trim 6H: Hard-faced 316 ball

Metal-to-metal  
firesafe contact

Flexible graphite  
flange gasket

#### Seating Design

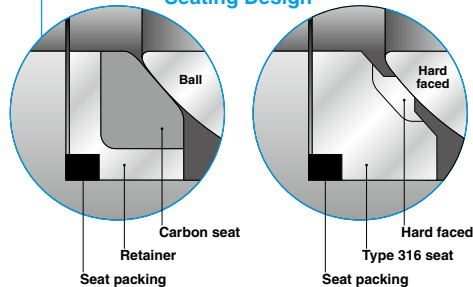

Note:  
Dimension of stem head are in accordance with CAPI ADDS 2.02, but the maximum specified dimension in CAPI ADDS 2.02 is "F14".  
For NPS 8 and 10, mounting pads are F16/ISO 5211.

**2" 150 UTDZ 6H**

**3H**

**6H**

## Technical Data

### 1. Choice of trim for heated abrasive service

Metal seated ball valves are guaranteed for a maximum service temperature of 300°C(572°F) (Trim symbol 5H) and 500°C(932°F) (Trim symbol 6H\*). For hard graphite seated ball valves, a maximum service temperature of 500°C(932°F) is also guaranteed (Trim symbol 3H\*). Heat resistant sealing and trim materials qualify these valves for heated abrasive service which cannot be properly handled by conventional soft seated ball valves due to the limited heat resistant characteristics and mechanical properties of their soft seats. "FILLTITE®" is a specially reinforced ball seat, made by using more carbon based fillers into PTFE than conventional carbon filled PTFE, which greatly improves heat and abrasion resistance. The material shows excellent operability, durability, chemical resistance and sealing performance at a high temperature of 300°C. In addition, the ball seat is replaceable with the most of our conventional ball seats, so it also has the cost advantage.

\* Temperature is limited to 425°C(797°F) for SCTDZ3H(M), 6H(M).

### 2. Unconditional firesafe provision

While metal or hard graphite seats are extremely heat resistant, other sealing components such as gland packing and flange gaskets are made of flexible graphite, another heat resistant material, so that no part of the valve will be affected by extraordinarily heated environments. Also the provision of an anti-static device is not required because of inter-component electric conductivity.

### 3. Maintenance ease

Split body construction of the valve body provides the convenience of easy maintenance, a critical requirement for handling slurries and other viscous fluids.

### 4. Valve automation

Quarter-turn valve drive mechanism makes mounting of valve automation measures such as electric and pneumatic actuators technically easier. KITZ floating ball valves employ integral actuator mounting pads, complying with ISO 5211 and CAPI, for easy, safe and assured on-the-spot actuator mounting without disassembly of valve glands.

### 5. High flow efficiency

Full port design provides maximized and linearized flow characteristic with minimal pressure loss as the line flow travels through the valve bore. This is a necessary design requirement particularly for trouble-free service of slurries and other viscous fluids.

### 6. Metal seated ball valves (Trim 5H/6H)

Rigid construction with full metallic contact between the ball and seats, and high durability of trim materials make KITZ metal seated ball valves ideally suited to highly abrasive services handling slurries and other viscous fluids.



#### ● Trim materials

Valve Design		Floating Ball Valve	
Trim symbol		5H	6H
Temp.		300°C	500°C *3
		572°F	932°F *3
Seat leakage*1		ANSI FCI 70-2 Class VI	
Parts	Ball	ASTM A276 Type 316 or ASTM A351 CF8M + Cr plated	ASTM A276 Type 316 or A351 Gr.CF8M + SFNi *2
	Ball Seat	ASTM A276 Type 316 + SFNi *2	ASTM A276 Type 316 + SFNi *2
	Stem	A 564 Type 630	A 564 Type 630

\*1 Maximum allowable seat leakage \*2 Ni-Cr alloy thermal spraying  
\*3 Temperature is limited to 425°C(797°F) for SCTDZ6H(M)

- Durable metal seat design and material also provides fully guaranteed throttling service performance, which makes KITZ metal seated ball valves function as a reliable control valve.
- Bi-directional flow.

#### Caution:

- Use a gear operator or valve actuator to fix the valve position when used for throttling service.

### 7. Carbon seated ball valves (Trim 3H)

- Bi-directional flow.
- Recommended for low abrasion service.

Valve Design		Floating Ball Valve	
Trim symbol		3H	
Temp.		500°C *5	
		932°F *5	
Seat leakage*1		ANSI FCI 70-2 Class VI	
Parts	Ball	ASTM A276 Type 304*1 or A351 Gr.CF8*2	
	Ball Seat	Carbon + JIS SUS329J1*3	
	Stem	ASTM A276 Type 304*4	

\*1 Maximum allowable seat leakage \*2 Shell material CF8M; Ball Type 316 or CF8M  
\*3 Equivalent to AISI Type 329 \*4 Shell material CF8M; Stem Type 316  
\*5 Temperature is limited to 425°C (797°F) for SCTD3H(M).

#### Caution:

- Not recommended for throttling service.
- Not recommended for high abrasion service.
- Maximum working temperature for oxidizing service, such as high temperature air, is 450°C (842°F).

### 8. FILLTITE® seated ball valves (Trim 1H)

- Highest heat resistance among PTFE based materials.

Valve Design		Floating Ball Valve	
Trim symbol		1H	
Temp.		300°C	
		572°F	
Parts	Ball	ASTM A276 Type 304*1 or A351 Gr.CF8*1	
	Ball Seat	FILLTITE® PTFE	
	Stem	ASTM A276 Type 304*2 ASTM A276 Type 316*2	

\*1 Shell material CF8M; Ball Type 316 or CF8M  
\*2 Shell material CF8M; Stem Type 316



# Ball Valve

## Technical Data

### Pressure - Temperature Rating

#### ● FILLTITE® seated floating ball valves: Trim 1H

Size: 1/2 to 21/2

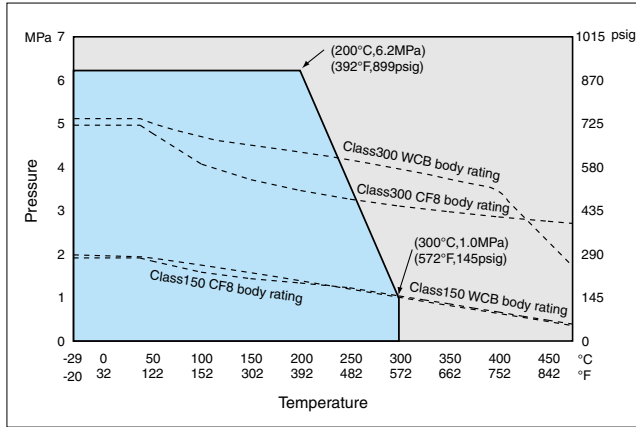

Size: 3 and 4

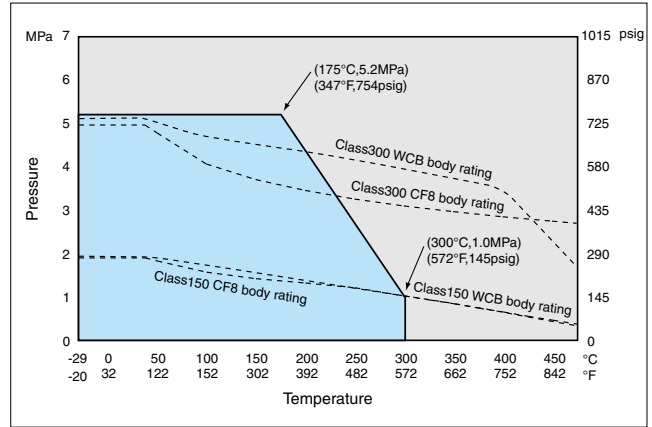

Size: 5 and 6

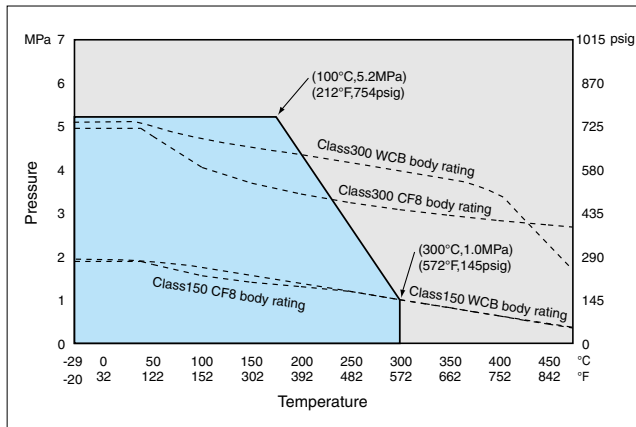

Size: 8 and 10

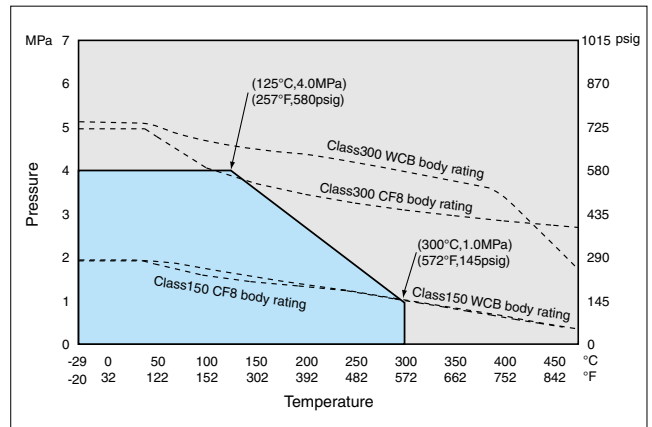

#### ● Hard graphite seated floating ball valves: Trim 3H

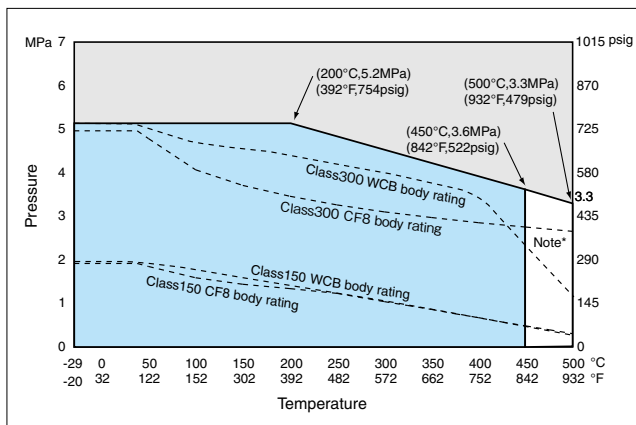

Note\* Maximum working temperature for oxidizing service, such as high temperature air, is 450°C(842°F).

Note: Temperature is limited to 425°C(797°F) for SCTDZ3H(M).

Note: 3H/5H/6H Serviceable temperature terminates at 300°C(572°F) for JIS 10K and at 425°C(797°F) for JIS 20K.

**Technical Date**

**Pressure - Temperature Rating**

● **Metal seated floating ball valves: Trim 5H** Size: 1/2 to 11/4

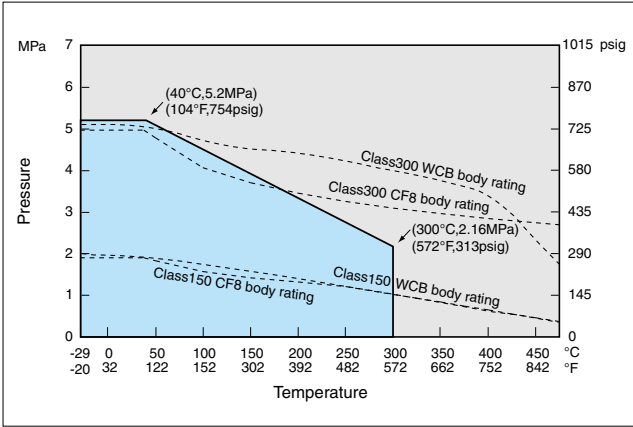

Size: 11/2 and 2

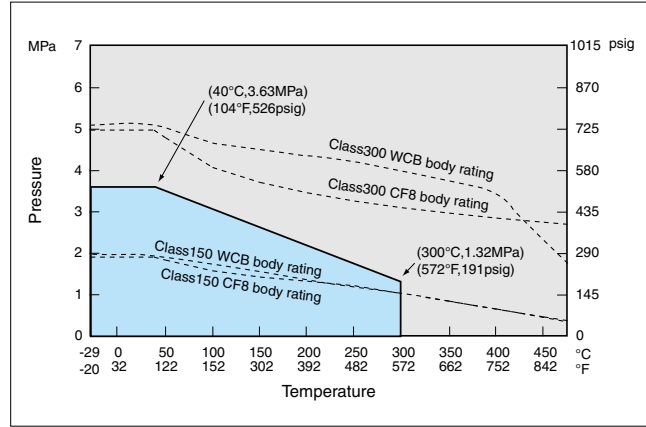

Size: 2 1/2 to 4

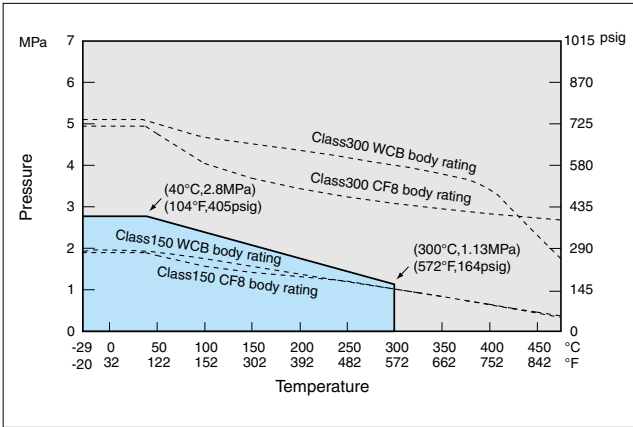

Size: 5 to 8

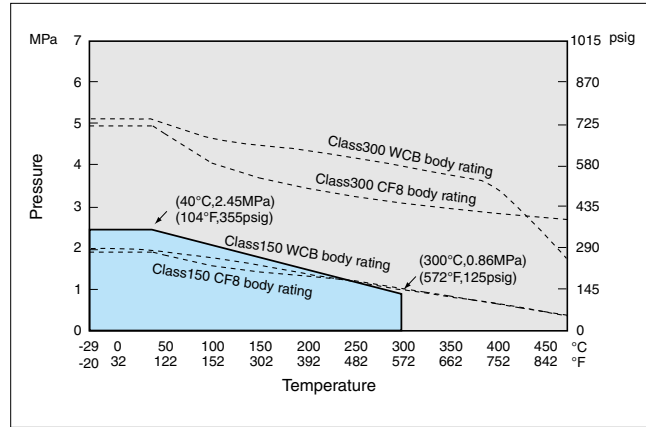

● **Metal seated floating ball valves: Trim 6H** Size: 1/2 to 5

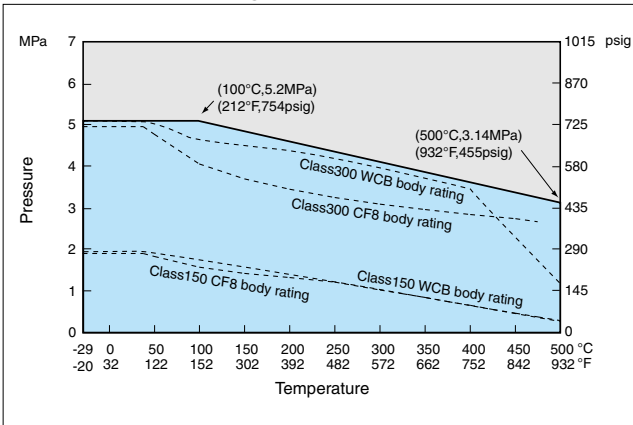

Size: 6 and 8

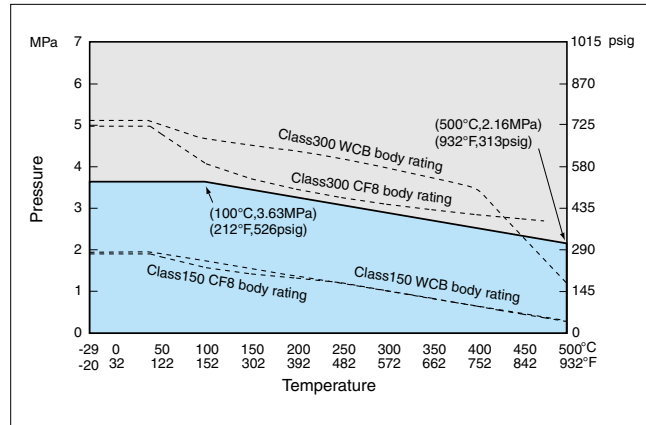

Note: Temperature is limited to 425°C(797°F) for SCTDZ6H(M).

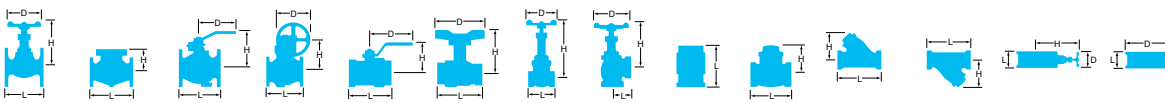

TYPE		FLOATING BALL			FLOATING BALL			FLOATING BALL			FLOATING BALL			FLOATING BALL			
Ball Valve																	
FIG		T			AKT			TT			TO			TF			
PRESSURE		Class 400			Class 400			Class 400			Class 400			Class 400			
END CONNECTION		BS21 (JIS B0203)			ASME B1.20.1			BS21 (JIS B0203)			BS21 (JIS B0203)			BS21 (JIS B0203)			
DIMENSIONS	inch	mm	L	H	D	L	H	D	L	H	D	L	H	D	L	H	D
	1/4	8	50	45	60	50	45	60	50	41	65	59	45	60	—	—	—
	3/8	10	50	45	60	50	45	60	50	41	65	60	45	60	—	—	—
	1/2	15	65	45	80	65	45	80	65	44	80	74	45	80	62	48	80
	3/4	20	68	50	80	68	50	80	68	48	80	80	50	80	73	54	110
	1	25	79	60	110	79	55	110	79	55	90	94	55	110	85	58	110
	1 1/4	32	86	60	110	86	60	110	86	61	105	—	—	—	98	64	110
	1 1/2	40	96	65	110	96	65	110	96	66	105	—	—	—	108	75	140
	2	50	109	75	140	109	75	140	109	80	120	—	—	—	124	84	150
	2 1/2	65	127	91	200	127	91	200	—	—	—	—	—	—	—	—	—
	3	80	153	105	300	153	105	300	—	—	—	—	—	—	—	—	—
	4	100	179	124	400	179	124	400	—	—	—	—	—	—	—	—	—
BODY		Brass			Forged Brass			Forged Brass			Forged Brass			Forged Brass			
BONNET		Forged Brass			Forged Brass			Forged Brass			Forged Brass			Forged Brass			
STEM		Special Brass			Special Brass			Special Brass			Special Brass			Special Brass			
DISC		Brass			Forged Brass			Forged Brass			Forged Brass			Forged Brass			
SEAT		PTFE			PTFE			PTFE			PTFE			PTFE			
		Standard Port			Reduced Port			Standard Port			Standard Port			Full Port			

TYPE		FLOATING BALL			FLOATING BALL			FLOATING BALL			FLOATING BALL			FLOATING BALL			
Ball Valve																	
FIG		TG			TB			TL			CTL			TLT			
PRESSURE		Class 400			10K			Class 400			Class 400			Class 400			
END CONNECTION		BS21 (JIS B0203)			JIS B2240			BS21 (JIS B0203)			ASME B16.18			BS21 (JIS B0203)			
DIMENSIONS	inch	mm	L	H	D	L	H	D	L	H	D	L	H	D	L	H	D
	1/4	8	50	45	60	—	—	—	—	—	—	—	—	—	—	—	—
	3/8	10	50	45	60	—	—	—	—	—	—	—	—	—	—	—	—
	1/2	15	65	45	80	110	85	130	56	75	80	58	75	80	56	79	82
	3/4	20	68	50	80	120	88	130	65	79	80	73	79	80	65	83	82
	1	25	79	55	110	130	95	160	78	83	110	88	83	110	78	90	94
	1 1/4	32	86	60	110	140	100	160	86	98	110	99	98	110	86	105	94
	1 1/2	40	96	65	110	165	115	230	96	102	110	114	102	110	96	109	94
	2	50	109	75	140	180	122	230	109	109	140	135	109	140	109	124	120
	2 1/2	65	127	91	200	190	153	400	—	—	—	—	—	—	—	—	—
	3	80	153	105	300	200	162	400	—	—	—	—	—	—	—	—	—
	4	100	—	—	—	230	190	460	—	—	—	—	—	—	—	—	—
BODY		Forged Brass			Cast Bronze			Cast Bronze			Cast Bronze			Cast Bronze			
BONNET		Forged Brass			Cast Bronze			Cast Bronze			Cast Bronze			Cast Bronze			
STEM		Special Brass			Special Brass			Special Brass			Special Brass			Special Brass			
DISC		Forged Brass			Forged Brass			Stainless Steel			Stainless Steel			Stainless Steel			
SEAT		PTFE			PTFE			PTFE			PTFE			PTFE			
		Standard Port			Full Port			Standard Port			Standard Port			Standard Port			

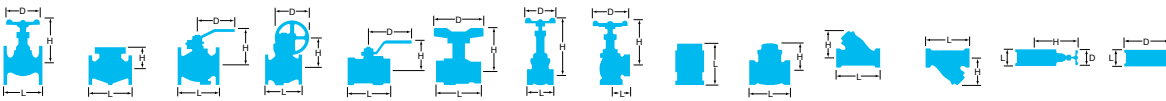

TYPE		FLOATING BALL			FLOATING BALL			FLOATING BALL			FLOATING BALL			FLOATING BALL			
Ball Valve																	
FIG		TFJ			TH			TM			TK			AKTK			
PRESSURE		Class 150			Class 400			Class 400			Class 600			Class 600			
END CONNECTION		BS21 (JIS B0203)			BS21 (JIS B0203)			BS21 (JIS B0203)			BS21 (JIS B0203)			BS21 (JIS B0203)			
DIMENSIONS	inch		L	H	D	L	H	D	L	H	D	L	H	D	L	H	D
	mm																
	1/8	6	-	-	-	-	-	-	-	-	-	32	31	60	-	-	-
	1/4	8	-	-	-	44	41	60	-	-	-	39	31	60	39	31	60
	3/8	10	-	-	-	45	41	60	56	45	60	44	36	70	44	36	70
	1/2	15	62	53	65	56	45	80	60	45	80	56.5	41	85	56.5	41	85
	3/4	20	73	58	65	63	48	80	68	49	80	59	44	85	59	44	85
	1	25	85	67	90	74	54	110	80	55	110	71	48	100	71	48	100
	1 1/4	32	98	72	90	82	58	110	86	60	110	78	54	100	78	54	100
	1 1/2	40	108	90	110	91	63	110	101	65	110	83	65	125	83	65	125
	2	50	124	98.5	110	104	74	140	117	75	140	100	72	125	100	72	125
	2 1/2	65	-	-	-	-	-	-	136	91	200	-	-	-	-	-	-
	3	80	-	-	-	-	-	-	160	105	300	-	-	-	-	-	-
BODY		Forged Brass			Forged Brass			Forged Brass			Forged Brass			Forged Brass			
BONNET		Forged Brass			Forged Brass			Forged Brass			Brass Rod			Brass Rod			
STEM		Special Brass			Special Brass			Special Brass			Special Brass			Special Brass			
DISC		Forged Brass			Forged Brass			Forged Brass			Forged Brass			Forged Brass			
SEAT		PTFE			PTFE			PTFE			G/R PTFE			PTFE			
		Full Port			Standard Port			Standard Port			Reduced Port			Reduced Port			

TYPE		FLOATING BALL			FLOATING BALL			3WAY FLOATING BALL			3WAY FLOATING BALL			3WAY FLOATING BALL			
Ball Valve																	
FIG		TKT			TKW			TN			AKTN			T4T			
PRESSURE		Class 600			Class 600			Class 400			Class 400			Class 400			
END CONNECTION		BS21 (JIS B0203)			BS21 (JIS B0203)			BS21 (JIS B0203)			BS21 (JIS B0203)			BS21 (JIS B0203)			
DIMENSIONS	inch		L	H	D	L	H	D	L	H	D	L	H	D	L	H	D
	mm																
	1/8	6	32	23	35	32	25	35	-	-	-	-	-	-	-	-	-
	1/4	8	39	23	35	39	25	35	40	30	60	40	30	60	-	-	-
	3/8	10	44	27	40	44	29	40	46	34	70	46	34	70	-	-	-
	1/2	15	56.5	31	60	56.5	35	55	67	45	80	67	45	80	70	52	130
	3/4	20	59	34	60	59	39	55	68	48	80	68	48	80	85	56	130
	1	25	71	42	76	71	40.8	69	79	55	110	79	55	110	100	63	150
	1 1/4	32	78	48	76	-	-	-	89	60	110	89	60	110	115	68	150
	1 1/2	40	83	53	100	-	-	-	100	65	110	100	65	110	130	94.5	230
	2	50	100	60	100	-	-	-	115	75	140	115	75	140	150	102	230
	2 1/2	65	-	-	-	-	-	-	138	91	200	138	91	200	-	-	-
	3	80	-	-	-	-	-	-	166	105	300	166	105	300	-	-	-
BODY		Forged Brass			Forged Brass			Forged Brass			Forged Brass			Cast Bronze			
BONNET		Brass Rod			Brass Rod			Forged Brass			Forged Brass			Forged Brass			
STEM		Special Brass			Special Brass			Special Brass			Special Brass			Special Brass			
DISC		Forged Brass			Forged Brass			Forged Brass			Forged Brass			Forged Brass			
SEAT		G/R PTFE			G/R PTFE			PTFE			PTFE			PTFE			
		Reduced Port			Reduced Port			Reduced Port			Reduced Port			Reduced Port			

Brass & Brass  
Cast Iron  
Ductile Iron  
Stainless Steel  
Carbon Steel  
Buttery Valve  
Ball Valve  
Ball Valve Seat  
Actuated Valve

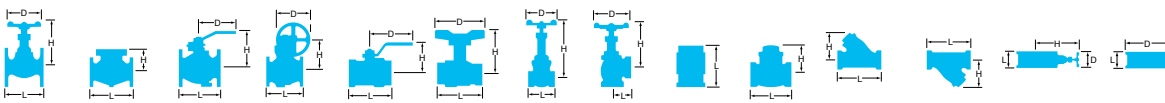

TYPE		3WAY FLOATING BALL			3 PIECE FLOATING BALL			FLOATING BALL			FLOATING BALL			FLOATING BALL			
Ball Valve																	
FIG		T4L			AK3TM			AKTAF			AKTAFM			SZA			
PRESSURE		Class 400			Class 600			Class 600			Class 600			Class 600			
END CONNECTION		BS21 (JIS B0203)			ASME B1.20.1			ASME B1.20.1			ASME B1.20.1			BS21 (JIS B0203)			
DIMENSIONS	inch	mm	L	H	D	L	H	D	L	H	D	L	H	D	L	H	D
	1/4	8	—	—	—	1.9	1.5	3.2	40.6	38.1	81.3	1.6	1.5	3.2	42	37	70
	3/8	10	—	—	—	1.9	1.5	3.2	40.6	38.1	81.3	1.6	1.5	3.2	42	37	70
	1/2	15	70	52	130	2.4	1.8	3.2	50.8	40.6	81.3	2	1.6	3.2	53	40	80
	3/4	20	85	56	130	2.7	2.1	3.9	58.4	50.8	99.1	2.3	2	3.9	60	43	80
	1	25	100	63	150	3.2	2.4	5.1	71.1	58.4	129.5	2.8	2.2	5.1	72	50	110
	1 1/4	32	115	68	150	3.9	2.7	5.1	81.3	63.5	129.5	3.2	2.5	5.1	84	55	110
	1 1/2	40	130	94.5	230	4.6	3	5.9	91.4	71.1	149.9	3.6	2.8	5.9	92	65	150
	2	50	150	102	230	5.4	3.3	5.9	104.1	78.7	149.9	4.1	3.1	5.9	110	72	150
	2 1/2	65	—	—	—	—	—	—	—	—	—	—	—	—	138	101	200
	3	80	—	—	—	—	—	—	—	—	—	—	—	—	167	113	300
	4	100	—	—	—	—	—	—	—	—	—	—	—	—	193	131	300
BODY		Cast Bronze			Forged Brass			Forged Brass			Forged Brass			Forged Brass			
BONNET		Forged Brass			Forged Brass			Forged Brass			Forged Brass			Forged Brass			
STEM		Special Brass			Special Brass			Special Brass			Stainless Steel			Brass Rod			
DISC		Forged Brass			Forged Brass			Forged Brass			Stainless Steel			Forged Brass			
SEAT		PTFE			PTFE			PTFE			PTFE			PTFE			
		Reduced Port			Full Port			Full Port			Full Port			Full Port			

TYPE		FLOATING BALL			FLOATING BALL			FLOATING BALL			FLOATING BALL			FLOATING BALL			
Ball Valve																	
FIG		AKSZA			PN40SZA			AKSZAW			AKTAFLL			10FCT			
PRESSURE		Class 600			PN40			Class 600			Class 600			10K			
END CONNECTION		ASME B1.20.1			BS21 (JIS B0203)			ASME B1.20.1			ASME B1.20.1			BS21 (JIS B0203)			
DIMENSIONS	inch	mm	L	H	D	L	H	D	L	H	D	L	H	D	L	H	D
	1/4	8	42	37	70	—	—	—	42	34	55	41	39	81	—	—	—
	3/8	10	42	37	70	—	—	—	42	34	55	42	39	81	72	71	130
	1/2	15	53	40	80	53	40	80	53	40	70	53	42	81	80	102	130
	3/4	20	60	43	80	60	43	80	60	44	70	60	51	100	85	105	130
	1	25	72	50	110	72	50	110	72	53	100	72	58	130	95	125	160
	1 1/4	32	84	55	110	84	55	110	84	58	100	82	64	130	120	130	160
	1 1/2	40	92	65	150	92	65	150	92	74	130	92	73	150	120	115	230
	2	50	110	72	150	110	72	150	110	81	130	105	80	150	140	120	230
	2 1/2	65	137	101	200	—	—	—	—	—	—	—	—	—	160	155	400
	3	80	167	113	300	—	—	—	—	—	—	—	—	—	182	165	400
	4	100	193	131	300	—	—	—	—	—	—	—	—	—	—	—	—
BODY		Forged Brass			Forged Brass			Forged Brass			Forged Brass			FC200			
BONNET		Forged Brass			Forged Brass			Forged Brass			Forged Brass			FC200			
STEM		Brass Rod			Brass Rod			Brass Rod			Special Brass			SUS403			
DISC		Forged Brass			Forged Brass			Forged Brass			Forged Brass			SUS304 / SCS13A			
SEAT		PTFE			PTFE			PTFE			PTFE			PTFE			
		Full Port			Full Port			Full Port			Full Port			Full Port			



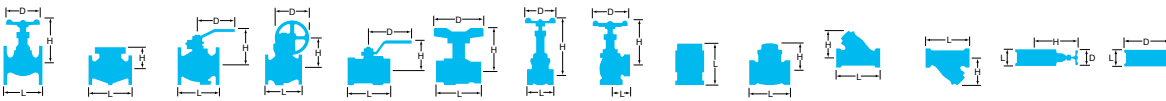

TYPE	FLOATING BALL					FLOATING BALL			FLOATING BALL			FLOATING BALL			3WAY FLOATING BALL		
Ball Valve																	
FIG	10FCTB					10FCTR			125FCTB			125FCTR			10FCTB2L		
PRESSURE	10K					10K			Class 125			Class 125			10K		
END CONNECTION	JIS B2239					JIS B2239			ASME B16.18			ASME B16.18			JIS B2239		
DIMENSIONS	inch	mm	L	H	D	L	H	D	L	H	D	L	H	D	L	H	D
	1/2	15	110	102	130	-	-	-	-	-	-	-	-	-	-	-	-
	3/4	20	120	105	130	-	-	-	-	-	-	-	-	-	-	-	-
	1	25	130	124	160	-	-	-	-	-	-	-	-	-	-	-	-
	1 1/4	32	140	128	160	-	-	-	-	-	-	-	-	-	-	-	-
	1 1/2	40	165	114	230	-	-	-	-	-	-	-	-	-	210	115	230
	2	50	180	121	230	-	-	-	178	120	230	-	-	-	220	120	230
	2 1/2	65	190	154	400	-	-	-	190	155	400	-	-	-	250	155	400
	3	80	200	163	400	-	-	-	203	165	400	-	-	-	260	165	400
	4	100	230	199	460	-	-	-	229	200	460	-	-	-	330	200	460
5	125	300	219	460	250	200	460	-	-	-	-	-	-	-	-	-	
6	150	340	292	1000	270	220	460	394	295	1000	267	220	460	-	-	-	
8	200	450	352	1500	290	295	1000	457	355	1500	292	295	1000	-	-	-	
10	250	-	-	-	330	355	1500	-	-	-	330	355	1500	-	-	-	
BODY	FC200					FC200			FC200			FC200			FC200		
BONNET	FC200					FC200			FC200			FC200			FC200		
STEM	SUS403					SUS403			SUS403			SUS403			SUS403		
DISC	SUS304 / SCS13A					SUS304 / SCS13A			SUS304 / SCS13A			SUS304 / SCS13A			SCS13A		
SEAT	PTFE					PTFE			PTFE			PTFE			PTFE		
	Full Port					Reduced Port			Full Port			Reduced Port			Full Port		

TYPE	3WAY FLOATING BALL					FLOATING BALL			FLOATING BALL			FLOATING BALL			3WAY FLOATING BALL		
Ball Valve																	
FIG	10FCTR2L					STZ			20ST			10STBF			10STB4TAF		
PRESSURE	10K					400LB			20K			10K			10K		
END CONNECTION	JIS B2239					BS21 (JIS B0203)			BS21 (JIS B0203)			JIS B2239			JIS B2239		
DIMENSIONS	inch	mm	L	H	D	L	H	D	L	H	D	L	H	D	L	H	D
	1/4	8	-	-	-	46	38	80	-	-	-	-	-	-	-	-	-
	3/8	10	-	-	-	51	38	80	-	-	-	-	-	-	-	-	-
	1/2	15	-	-	-	57	42	100	75	106	130	108	106	130	-	-	-
	3/4	20	-	-	-	65	49	130	80	106	130	117	109	130	-	-	-
	1	25	-	-	-	76	52	130	90	107	130	127	130	160	-	-	-
	1 1/4	32	-	-	-	86	57	130	105	129	160	140	135	160	-	-	-
	1 1/2	40	-	-	-	95	63	130	115	133	160	165	115	230	180	143	400
	2	50	-	-	-	115	68	150	130	114	230	178	120	230	200	152	400
	2 1/2	65	-	-	-	-	-	-	-	-	-	190	153	400	240	183	460
3	80	-	-	-	-	-	-	-	-	-	203	162	400	260	190	460	
4	100	-	-	-	-	-	-	-	-	-	229	199	460	330	259	1000	
5	125	370	205	460	-	-	-	-	-	-	356	219	460	-	-	-	
6	150	430	225	460	-	-	-	-	-	-	394	293	1000	-	-	-	
8	200	540	295	1000	-	-	-	-	-	-	457	352	1500	-	-	-	
10	250	-	-	-	-	-	-	-	-	-	-	-	-	-	-	-	
BODY	FC200					Ductile Iron			Ductile Iron			Ductile Iron			Ductile Iron		
BONNET	FC200					Ductile Iron			Ductile Iron			Ductile Iron			Ductile Iron		
STEM	SUS403					Special Brass			SUS403			SUS304			SUS304		
DISC	SCS13A					C3771BE			SUS304 / SCS13A			SCS13A / SUS304			SCS13A / SUS304		
SEAT	PTFE					G/F PTFE			HYPATITE PTFE			PTFE			HYPATITE PTFE		
	Reduced Port					Reduced Port			Reduced Port			Full Port			Full Port		



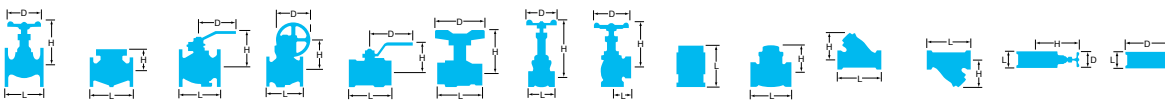

Brass & Bronze  
Cast Iron  
Ductile Iron  
Stainless Steel  
Carbon Steel  
Buttery Valve  
Ball Valve  
Ball Valve Seat  
Actuated Valve



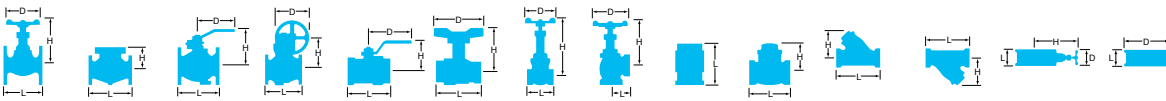



TYPE		3WAY FLOATING BALL			3WAY FLOATING BALL			3WAY FLOATING BALL			FLOATING BALL			FLOATING BALL			
Ball Valve																	
FIG		10STB4LAF			10STR4TAF			10STR4LAF			10STLBF			20STLB			
PRESSURE		10K			10K			10K			10K			20K			
END CONNECTION		JIS B2239			JIS B2239			JIS B2239			JIS B2239			JIS B2239			
DIMENSIONS	inch	mm	L	H	D	L	H	D	L	H	D	L	H	D	L	H	D
	1/2	15	-	-	-	-	-	-	-	-	-	108	106	130	140	106	130
	3/4	20	-	-	-	-	-	-	-	-	-	117	109	130	152	109	130
	1	25	-	-	-	-	-	-	-	-	-	127	130	160	165	130	160
	1 1/4	32	-	-	-	-	-	-	-	-	-	140	135	160	178	135	160
	1 1/2	40	180	143	400	-	-	-	-	-	-	165	115	230	190	115	230
	2	50	200	152	400	-	-	-	-	-	-	178	120	230	216	120	230
	2 1/2	65	240	183	460	-	-	-	-	-	-	190	153	400	241	153	400
	3	80	260	190	460	-	-	-	-	-	-	203	162	400	283	162	400
	4	100	330	259	1000	-	-	-	-	-	-	229	199	460	305	241	750
	5	125	-	-	-	340	259	1000	340	259	1000	356	219	460	-	-	-
	6	150	-	-	-	400	281	1000	400	281	1000	394	293	1000	403	293	1000
	8	200	-	-	-	450	323	1500	450	323	1500	457	352	1500	502	352	1500
BODY		Ductile Iron			Ductile Iron			Ductile Iron			Ductile Iron			Ductile Iron			
BONNET		Ductile Iron			Ductile Iron			Ductile Iron			Ductile Iron			Ductile Iron			
STEM		SUS304			SUS304			SUS304			SUS403			SUS403			
DISC		SCS13A / SUS304			SCS13A			SCS13A			SCS13A / SUS304			SUS304 / SCS13A			
SEAT		HYPATITE PTFE			HYPATITE PTFE			HYPATITE PTFE			PTFE			HYPATITE PTFE			
		Full Port			Reduced Port			Reduced Port			Full Port			Full Port			

TYPE		FLOATING BALL			FLOATING BALL			FLOATING BALL			FLOATING BALL			FLOATING BALL			
Ball Valve																	
FIG		UTK			UTKM			UTKW			UTKMW			UTFM			
PRESSURE		Class 600			Class 600			Class 600			Class 600			Class 1000			
END CONNECTION		BS21 (JIS B0203)			BS21 (JIS B0203)			BS21 (JIS B0203)			BS21 (JIS B0203)			BS21 (JIS B0203)			
DIMENSIONS	inch	mm	L	H	D	L	H	D	L	H	D	L	H	D	L	H	D
	1/4	8	39	31	60	39	31	60	39	25	35	39	25	35	-	-	-
	3/8	10	44	36	70	44	36	70	44	29	40	44	29	40	-	-	-
	1/2	15	56.5	41	85	56.5	41	85	56.5	35	55	56.5	35	55	62	53	100
	3/4	20	59	44	85	59	44	85	59	39	55	59	39	55	73	63	130
	1	25	71	48	100	71	48	100	71	41	69	71	41	69	85	67	130
	1 1/4	32	78	54	100	78	54	100	-	-	-	-	-	-	98	75	150
	1 1/2	40	83	65	125	83	65	125	-	-	-	-	-	-	108	81	150
	2	50	100	72	125	100	72	125	-	-	-	-	-	-	124	102	200
BODY		SCS13A			SCS14A			SCS13A			SCS14A			SCS14A			
BONNET		-			-			-			-			SCS14A			
STEM		SUS316 / SUS304			SUS316			SUS316 / SUS304			SUS316			SUS316			
DISC		SUS316 / SUS304			SUS316			SUS316 / SUS304			SUS316			SCS316 / SCS14A			
SEAT		G/F PTFE			G/F PTFE			G/F PTFE			G/F PTFE			HYPATITE PTFE			
		Reduced Port			Reduced Port			Reduced Port			Reduced Port			Full Port			



TYPE	FLOATING BALL						FLOATING BALL			FLOATING BALL			3WAY FLOATING BALL			3WAY FLOATING BALL		
Ball Valve																		
FIG	UTH						UTHM			UTHL			UTH4LM			UTH4TM		
PRESSURE	Class 800						Class 800			Class 1000			Class 800			Class 800		
END CONNECTION	BS21 (JIS B0203)						BS21 (JIS B0203)			BS21 (JIS B0203)			BS21 (JIS B0203)			BS21 (JIS B0203)		
DIMENSIONS	inch	mm	L	H	D	L	H	D	L	H	D	L	H	D	L	H	D	
			1/2	15	60	47	100	60	47	100	60	76	100	69	63	130	69	63
	3/4	20	70	54	100	70	54	100	70	80	100	84	65	130	84	65	130	
	1	25	80	63	130	80	63	130	80	85	130	96	75.5	150	96	75.5	150	
	1 1/4	32	95	68	130	95	68	130	95	99	130	114	79.5	150	114	79.5	150	
	1 1/2	40	108	79	150	108	78	150	108	105	150	132	95.5	230	132	95.5	230	
2	50	124	85	150	124	85	150	124	113	150	150	101	230	150	101	230		
BODY	SCS13A						SCS14A			SCS13A			SCS14A			SCS14A		
BONNET	SCS13A						SCS14A			SCS13A			SCS14A			SCS14A		
STEM	SUS304						SUS316			SUS304			SUS316			SUS316		
DISC	SUS304						SUS316			SUS304			SUS316 / SCS14A			SUS316 / SCS14A		
SEAT	PTFE						PTFE			HYPATITE PTFE			HYPATITE PTFE			HYPATITE PTFE		
	Reduced Port						Reduced Port			Reduced Port			Reduced Port			Reduced Port		

TYPE	3 PIECE FLOATING BALL						3 PIECE FLOATING BALL			FLOATING BALL			FLOATING BALL			FLOATING BALL		
Ball Valve																		
FIG	U3TZM						SWU3TZM			10UT			10UTB / G-10UTB			10UTDZ		
PRESSURE	Class 1000						Class 1000			10K			10K			10K		
END CONNECTION	BS21 (JIS B0203)						JIS B2316			BS21 (JIS B0203)			JIS B2220			JIS B2220		
DIMENSIONS	inch	mm	L	H	D	L	H	D	L	H	D	L	H	D	L	H	D	
			3/8	10	-	-	-	-	-	-	62	71	130	-	-	-	-	-
	1/2	15	63	48	120	63	48	120	65	102	130	110	102	130	108	108	130	
	3/4	20	71	60	130	71	60	130	80	105	130	120	105	130	117	111	130	
	1	25	90	69	130	90	69	130	90	124	160	130	124	160	127	124	160	
	1 1/4	32	103	83	150	103	83	150	110	130	160	140	128	160	140	128	160	
	1 1/2	40	110	88	150	110	88	150	120	115	230	165	115	230	165	134	230	
	2	50	127	104	180	127	104	180	140	120	230	180	120	230	178	143	230	
	2 1/2	65	-	-	-	-	-	-	-	160	155	400	190	155	400	190	179	400
	3	80	-	-	-	-	-	-	-	182	165	400	200	165	400	203	189	400
	4	100	-	-	-	-	-	-	-	-	-	-	230	200	460	229	224	460
	5	125	-	-	-	-	-	-	-	-	-	-	300	220	460	356	240	460
6	150	-	-	-	-	-	-	-	-	-	-	340	295	1000	394	315	1000	
8	200	-	-	-	-	-	-	-	-	-	-	450	355	1500	457	406	1500	
10	250	-	-	-	-	-	-	-	-	-	-	533	477	500	-	-	-	
BODY	SCS14A						SCS14A			SCS13A			SCS13A			SCS13A		
BONNET	SCS14A						SCS14A			SCS13A			SCS13A			SCS13A		
STEM	SUS316						SUS316			SUS304			SUS304			SUS304		
DISC	SUS316 / SCS14A						SUS316 / SCS14A			SUS304 / SCS13A			SUS304 / SCS13A			SUS304 / SCS13A		
SEAT	HYPATITE PTFE						HYPATITE PTFE			PTFE			HYPATITE PTFE			HYPATITE PTFE		
	Reduced Port						Reduced Port			Full Port			Full Port SIZE.10 Gear operation type			Full Port		

Brass & Bronze

Cast Iron

Ductile Iron

Stainless Steel

Carbon Steel

Battery Valve

Ball Valve

Ball Valve Seat

Actuated Valve

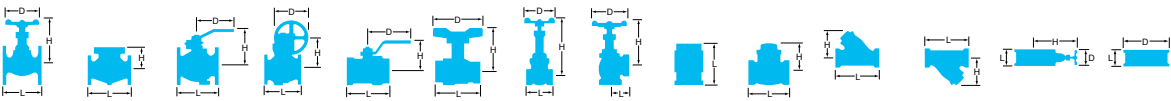

TYPE		FLOATING BALL			FLOATING BALL			FLOATING BALL			FLOATING BALL			FLOATING BALL			
Ball Valve																	
FIG		10UTDZM			20UTDZ			20UTDZM			10UTR			20UTR			
PRESSURE		10K			20K			20K			10K			20K			
END CONNECTION		JIS B2220			JIS B2220			JIS B2220			JIS B2220			JIS B2220			
DIMENSIONS	inch	mm	L	H	D	L	H	D	L	H	D	L	H	D	L	H	D
	mm	mm	mm	mm	mm	mm	mm	mm	mm	mm	mm	mm	mm	mm	mm	mm	mm
	1/2	15	108	108	130	140	108	130	140	108	130	—	—	—	—	—	—
	3/4	20	117	111	130	152	111	130	152	111	130	—	—	—	—	—	—
	1	25	127	124	160	165	124	160	165	124	160	—	—	—	—	—	—
	1 1/4	32	140	128	160	178	128	160	178	128	160	—	—	—	—	—	—
	1 1/2	40	165	134	230	190	134	230	190	134	230	—	—	—	—	—	—
	2	50	178	143	230	216	143	230	216	143	230	—	—	—	216	115	230
	2 1/2	65	190	179	400	241	179	400	241	179	400	—	—	—	—	—	—
	3	80	203	189	400	283	189	400	283	189	400	203	155	400	283	155	400
	4	100	229	224	460	305	251	750	305	251	750	229	165	400	305	165	400
	5	125	356	240	460	381	267	750	381	267	750	250	200	460	—	—	—
	6	150	394	315	1000	403	315	1000	403	315	1000	270	220	460	403	260	750
	8	200	457	406	1500	502	406	1500	502	406	1500	290	295	1000	419	295	1000
	10	250	—	—	—	—	—	—	—	—	—	330	355	1500	—	—	—
BODY		SCS14A			SCS13A			SCS14A			SCS13A			SCS13A			
BONNET		SCS14A			SCS13A			SCS14A			SCS13A			SCS13A			
STEM		SUS316			SUS304			SUS316			SUS304			SUS304			
DISC		SUS316 / SCS14A			SUS304 / SCS13A			SUS316 / SCS14A			SUS304 / SCS13A			SUS304 / SCS13A			
SEAT		HYPATITE PTFE			HYPATITE PTFE			HYPATITE PTFE			HYPATITE PTFE			HYPATITE PTFE			
		Full Port			Full Port			Full Port			Reduced Port			Reduced Port			

TYPE		FLOATING BALL			FLOATING BALL			FLOATING BALL			FLOATING BALL			FLOATING BALL			
Ball Valve																	
FIG		150UTB / G-150UTB			150UTBM			150UTDZ / G-150UTDZ			150UTDZM / G-150UTDZM			300UTDZ			
PRESSURE		Class 150			Class 150			Class 150			Class 150			Class 300			
END CONNECTION		ASME B16.18			ASME B16.18			ASME B16.18			ASME B16.18			ASME B16.18			
DIMENSIONS	inch	mm	L	H	D	L	H	D	L	H	D	L	H	D	L	H	D
	mm	mm	mm	mm	mm	mm	mm	mm	mm	mm	mm	mm	mm	mm	mm	mm	mm
	1/2	15	108	102	130	108	102	130	108	108	130	108	108	130	140	108	130
	3/4	20	117	105	130	117	105	130	117	111	130	117	111	130	152	111	130
	1	25	127	124	160	127	124	160	127	124	160	127	124	160	165	124	160
	1 1/4	32	—	—	—	—	—	—	140	128	160	140	128	160	—	—	—
	1 1/2	40	165	115	230	165	115	230	165	134	230	165	134	230	190	134	230
	2	50	178	120	230	178	120	230	178	143	230	178	143	230	216	143	230
	2 1/2	65	190	155	400	190	155	400	190	179	400	190	179	400	241	179	400
	3	80	203	165	400	203	165	400	203	189	400	203	189	400	283	189	400
	4	100	229	200	460	229	200	460	229	224	460	229	224	460	305	251	750
	5	125	356	220	460	356	220	460	356	240	460	356	240	460	—	—	—
	6	150	394	295	1000	394	295	1000	394	315	1000	394	315	1000	403	315	1000
	8	200	457	355	1500	457	355	1500	457	406	1500	457	406	1500	502	406	1500
	10	250	533	477	500	—	—	—	533	448	500	533	448	500	—	—	—
BODY		A351 Gr.CF8			A351 Gr.CF8M			A351 Gr.CF8			A351 Gr.CF8M			A351 Gr.CF8			
BONNET		A351 Gr.CF8			A351 Gr.CF8M			A351 Gr.CF8			A351 Gr.CF8M			A351 Gr.CF8			
STEM		A276 TYPE304			TYPE316			A276 TYPE304			A276 TYPE316			A276 TYPE304			
DISC		TYPE304 / A351 Gr.CF8			TYPE316 / A351 Gr.CF8M			A276 TYPE304 / A351Gr.CF8			A276 TYPE316 / A351 Gr.CF8M			A276 TYPE304 / A351 Gr.CF8			
SEAT		HYPATITE PTFE			HYPATITE PTFE			HYPATITE PTFE			HYPATITE PTFE			HYPATITE PTFE			
		Full Port SIZE:10 Gear operation type			Full Port			Full Port SIZE:10 Gear operation type			Full Port SIZE:10 Gear operation type			Full Port			

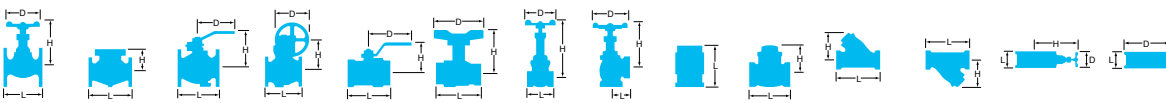

TYPE		FLOATING BALL					FLOATING BALL			FLOATING BALL			3WAY FLOATING BALL			3WAY FLOATING BALL		
Ball Valve																		
FIG		300UTDZM					150UTR			300UTR			10UTB2T			10UTB2TM		
PRESSURE		Class 300					Class 150			Class 300			10K			10K		
END CONNECTION		ASME B16.18					ASME B16.18			ASME B16.18			JIS B2220			JIS B2220		
DIMENSIONS		inch	mm	L	H	D	L	H	D	L	H	D	L	H	D	L	H	D
		1/2	15	140	108	130	-	-	-	-	-	-	-	-	-	-	-	-
		3/4	20	152	111	130	-	-	-	-	-	-	-	-	-	-	-	-
		1	25	165	124	160	-	-	-	-	-	-	165	124	160	165	124	160
		1 1/2	40	190	134	230	-	-	-	-	-	-	210	115	230	210	115	230
		2	50	216	143	230	178	115	230	216	115	230	220	123	230	220	123	230
		2 1/2	65	241	179	400	-	-	-	-	-	-	250	155	400	250	155	400
		3	80	283	189	400	203	155	400	283	155	400	260	165	400	260	165	400
		4	100	305	251	750	229	165	400	305	165	400	330	200	460	330	200	460
		5	125	-	-	-	254	200	460	-	-	-	-	-	-	-	-	-
		6	150	403	315	1000	267	220	460	403	260	750	-	-	-	-	-	-
		8	200	502	406	1500	292	295	1000	419	295	1000	-	-	-	-	-	-
		10	250	-	-	-	330	355	1500	457	355	1500	-	-	-	-	-	-
BODY		A351 Gr.CF8M					A351 Gr.CF8			A351 Gr.CF8			SCS13A			SCS14A		
BONNET		A351 Gr.CF8M					A351 Gr.CF8			A351 Gr.CF8			SCS13A			SCS14A		
STEM		A276 TYPE316					TYPE304			TYPE304			SUS304			SUS316		
DISC		A276 TYPE316 / A351 Gr.CF8M					TYPE304 / A351 Gr.CF8			TYPE304 / A351 Gr.CF8			SUS304 / SCS13A			SUS316 / SCS14A		
SEAT		HYPATITE PTFE					HYPATITE PTFE			HYPATITE PTFE			HYPATITE PTFE			HYPATITE PTFE		
		Full Port					Reduced Port			Reduced Port			Full Port			Full Port		

TYPE		3WAY FLOATING BALL					3WAY FLOATING BALL			3WAY FLOATING BALL			3WAY FLOATING BALL			3WAY FLOATING BALL		
Ball Valve																		
FIG		10UTB2L					10UTR2L			10UTB2LM			10UTB4LA			10UTB4LAM		
PRESSURE		10K					10K			10K			10K			10K		
END CONNECTION		JIS B2220					JIS B2220			JIS B2220			JIS B2220			JIS B2220		
DIMENSIONS		inch	mm	L	H	D	L	H	D	L	H	D	L	H	D	L	H	D
		1/2	15	-	-	-	-	-	-	-	-	-	120	128	160	120	128	160
		3/4	20	-	-	-	-	-	-	-	-	-	140	132	160	140	132	160
		1	25	165	124	160	-	-	-	165	124	160	160	135	160	160	135	160
		1 1/2	40	210	115	230	-	-	-	210	115	230	180	146	400	180	146	400
		2	50	220	123	230	-	-	-	220	123	230	200	155	400	200	155	400
		2 1/2	65	250	155	400	-	-	-	250	155	400	240	185	460	240	185	460
		3	80	260	165	400	-	-	-	260	165	400	260	198	460	260	198	460
		4	100	330	200	460	-	-	-	330	200	460	330	267	1000	330	267	1000
		5	125	-	-	-	-	-	-	-	-	-	-	-	-	-	-	-
		6	150	-	-	-	430	220	460	-	-	-	-	-	-	-	-	-
BODY		SCS13A					SCS13A			SCS14A			SCS13A			SCS14A		
BONNET		SCS13A					SCS13A			SCS14A			SCS13A			SCS14A		
STEM		SUS304					SUS304			SUS316			SUS304			SUS316		
DISC		SUS304 / SCS13A					SCS13A			SUS316 / SCS14A			SUS304 / SCS13A			SUS316 / SCS14A		
SEAT		HYPATITE PTFE					HYPATITE PTFE			HYPATITE PTFE			HYPATITE PTFE			HYPATITE PTFE		
		Full Port					Reduced Port			Reduced Port			Full Port			Full Port		

Brass & Bronze

Cast Iron

Ductile Iron

Stainless Steel

Carbon Steel

Battery Valve

Ball Valve

Ball Valve Seat

Actuated Valve

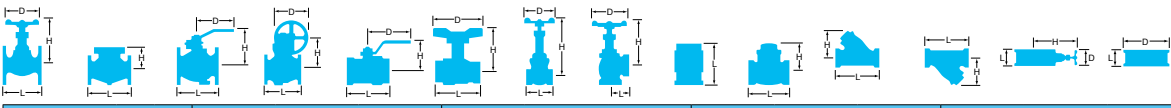

TYPE		3WAY FLOATING BALL			3WAY FLOATING BALL			FLOATING BALL			FLOATING BALL			FLOATING BALL			
Ball Valve																	
FIG		10UTB4TA			10UTB4TAM			10UTBLN			10UTBT			10UTBJ			
PRESSURE		10K			10K			10K			10K			10K			
END CONNECTION		JIS B2220			JIS B2220			JIS B2220			JIS B2220			JIS B2220			
DIMENSIONS	inch	mm	L	H	D	L	H	D	L	H	D	L	H	D	L	H	D
	1/2	15	120	128	160	120	128	160	140	104	130	—	—	—	110	131	130
	3/4	20	140	132	160	140	132	160	152	106	130	—	—	—	120	135	130
	1	25	160	135	160	160	135	160	165	129	160	105	150	160	130	150	160
	1 1/2	40	180	146	400	180	146	400	191	118	230	125	134	230	165	150	230
	2	50	200	155	400	200	155	400	216	124	230	143	143	230	180	157	230
	2 1/2	65	240	185	460	240	185	460	240	157	400	160	177	400	190	188	400
	3	80	260	198	460	260	198	460	250	166	400	167	187	400	—	—	—
	4	100	330	267	1000	330	267	1000	280	204	460	176.5	222	460	—	—	—
	5	125	—	—	—	—	—	—	—	—	—	227	242	460	—	—	—
	6	150	—	—	—	—	—	—	—	—	—	265	312	1000	—	—	—
BODY		SCS13A			SCS14A			SCS13A			SCS13A			SCS13A			
BONNET		SCS13A			SCS14A			SCS13A			SCS13A			SCS13A			
STEM		SUS304			SUS316			SUS304			SUS304			SUS304			
DISC		SUS304 / SCS13A			SUS316 / SCS14A			SUS304 / SCS13A			SUS304 / SCS13A			SUS304 / SCS13A			
SEAT		HYPATITE PTFE			HYPATITE PTFE			HYPATITE PTFE			HYPATITE PTFE			HYPATITE PTFE			
		Full Port			Full Port			Full Port PEA Lining			Full Port Tank Ball Valve L is dimenstions except Tank pad			Full Port Jacketed			

TYPE		FLOATING BALL			FLOATING BALL			FLOATING BALL			LAMBDA PORT			LAMBDA PORT			
Ball Valve																	
FIG		10UTBJM			150UTBJ			300UTBJ			L-10UVC			L-150UVC / G-150UVC			
PRESSURE		10K			Class 150			Class 300			10K			Class 150			
END CONNECTION		JIS B2220			ASME B16.18			ASME B16.18			JIS B2220			ASME B16.18			
DIMENSIONS	inch	mm	L	H	D	L	H	D	L	H	D	L	H	D	L	H	D
	1/2	15	110	131	130	110	131	130	140	128	130	—	—	—	—	—	—
	3/4	20	120	135	130	120	135	130	152	132	130	—	—	—	—	—	—
	1	25	130	150	160	130	150	160	165	150	160	127	181	160	127	181	160
	1 1/2	40	165	150	230	165	150	230	190	150	230	165	199	230	165	199	230
	2	50	180	157	230	180	157	230	216	157	230	178	205	230	178	205	230
	2 1/2	65	190	188	400	190	188	400	241	187	400	190	252	400	190	252	400
	3	80	—	—	—	—	—	—	283	212	400	203	259	400	203	259	400
	4	100	—	—	—	—	—	—	305	238	750	229	292	460	229	292	460
	5	150	—	—	—	—	—	—	403	261	1000	394	411	1000	394	411	1000
	6	200	—	—	—	—	—	—	—	—	—	457	483	1500	457	483	1500
	10	250	—	—	—	—	—	—	—	—	—	—	—	—	533	446	500
BODY		SCS14A			A351 Gr.CF8M			A351 Gr.CF8M			SCS13A			A351 Gr.CF8			
BONNET		SCS14A			A351 Gr.CF8M			A351 Gr.CF8M			SCS13A			A351 Gr.CF8			
STEM		SUS316			A276 TYPE304			A276 TYPE304			SUS316			TYPE316			
DISC		SUS316 / SCS14A			A276 TYPE304 / A351 Gr.CF8			A276 TYPE304 / A351 Gr.CF8			SCS14A			A351 Gr.CF8M			
SEAT		HYPATITE PTFE			HYPATITE PTFE			HYPATITE PTFE			—			—			
		Full Port Jacketed			Full Port Jacketed			Full Port Jacketed						SIZE:10 Gear operation type			

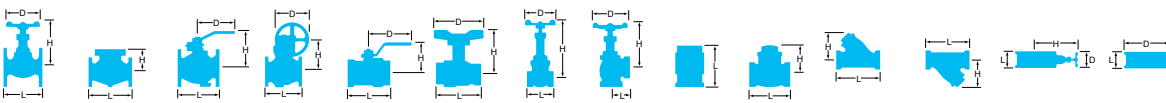

TYPE		FLOATING BALL			FLOATING BALL			FLOATING BALL			FLOATING BALL			FLOATING BALL			
Ball Valve																	
FIG		10UTDZ1H			10UTDZ1HM			20UTDZ1H / G-20UTDZ1H			10UTDZ3H / G-10UTDZ3H			20UTDZ3H / G-20UTDZ3H			
PRESSURE		10K			10K			20K			10K			20K			
END CONNECTION		JIS B2220			JIS B2220			JIS B2220			JIS B2220			JIS B2220			
DIMENSIONS	inch	mm	L	H	D	L	H	D	L	H	D	L	H	D	L	H	D
	1/2	15	108	108	130	108	108	130	140	108	130	108	108	130	140	108	130
	3/4	20	117	111	130	117	111	130	152	111	130	117	111	130	152	111	130
	1	25	127	124	160	127	124	160	165	124	160	127	124	160	165	124	160
	1 1/4	32	140	128	160	140	128	160	178	128	160	140	128	160	178	128	160
	1 1/2	40	165	134	230	165	134	230	190	134	230	165	134	230	190	139	600
	2	50	178	143	230	178	143	230	216	143	230	178	148	300	216	148	600
	2 1/2	65	190	179	400	190	179	400	241	179	400	190	209	600	241	209	1000
	3	80	203	189	400	203	189	400	283	189	400	203	219	600	283	219	1000
	4	100	229	251	750	229	251	750	305	258	310	229	251	1000	305	286	360
	5	125	-	-	-	-	-	-	381	302	360	356	274	310	381	302	360
	6	150	-	-	-	-	-	-	403	332	500	394	335	360	403	360	500
	8	200	-	-	-	-	-	-	502	417	500	457	417	500	502	489	500
BODY		SCS13A			SCS14A			SCS13A			SCS13A			SCS13A			
BONNET		SCS13A			SCS14A			SCS13A			SCS13A			SCS13A			
STEM		SUS304			SUS316			SUS304			SUS304			SUS304			
DISC		SUS304 / SCS13A			SUS316 / SCS14A			SUS304 / SCS13A			SUS304 / SCS13A			SUS304 / SCS13A			
SEAT		FILLTITE PTFE			FILLTITE PTFE			FILLTITE PTFE			CARBON+329J1			CARBON+329J1			
		Full Port			Full Port			Full Port SIZE:5-8 Gear operation type			Full Port SIZE:5-8 Gear operation type			Full Port SIZE:5-8 Gear operation type			

TYPE		FLOATING BALL			FLOATING BALL			FLOATING BALL			FLOATING BALL			FLOATING BALL			
Ball Valve																	
FIG		10UTDZ5H / G-10UTDZ5H			20UTDZ5H / G-20UTDZ5H			10UTDZ6H / G-10UTDZ6H			10UTDZ6HM			20UTDZ6H / G-20UTDZ6H			
PRESSURE		10K			20K			10K			10K			20K			
END CONNECTION		JIS B2220			JIS B2220			JIS B2220			JIS B2220			JIS B2220			
DIMENSIONS	inch	mm	L	H	D	L	H	D	L	H	D	L	H	D	L	H	D
	1/2	15	108	108	130	140	108	130	108	108	130	108	108	130	140	108	130
	3/4	20	117	111	130	152	111	130	117	111	130	117	111	130	152	111	130
	1	25	127	124	160	165	124	160	127	124	160	127	124	160	165	124	160
	1 1/4	32	140	128	160	178	128	160	140	128	160	140	128	160	178	128	160
	1 1/2	40	165	134	230	190	139	600	165	134	230	165	134	230	190	139	600
	2	50	178	148	300	216	148	600	178	148	300	178	148	300	216	148	600
	2 1/2	65	190	209	600	241	209	1000	190	209	600	190	209	600	241	209	1000
	3	80	203	219	600	283	219	1000	203	219	600	203	219	600	283	219	1000
	4	100	229	251	1000	305	286	360	229	251	1000	229	251	1000	305	286	360
	5	125	356	302	360	381	299	500	356	302	360	-	-	-	381	299	500
	6	150	394	335	360	403	360	500	394	335	360	-	-	-	403	360	500
	8	200	457	417	500	502	489	500	457	417	500	-	-	-	502	489	500
BODY		SCS13A			SCS13A			SCS13A			SCS14A			SCS14A			
BONNET		SCS13A			SCS13A			SCS13A			SCS14A			SCS14A			
STEM		SUS630			SUS630			SUS630			SUS630			SUS630			
DISC		SUS316+Cr PLATING			SUS316+Cr PLATING			SUS316+Ni-Cr ALLOY			SUS316+Ni-Cr ALLOY			SUS316+Ni-Cr ALLOY			
SEAT		SUS316+Ni-Cr ALLOY			SUS316+Ni-Cr ALLOY			SUS316+Ni-Cr ALLOY			SUS316+Ni-Cr ALLOY			SUS316+Ni-Cr ALLOY			
		Full Port SIZE:5-8 Gear operation type			Full Port SIZE:5-8 Gear operation type			Full Port SIZE:5-8 Gear operation type			Full Port			Full Port SIZE:4-8 Gear operation type			

Brass & Bronze

Cast Iron

Ductile Iron

Stainless Steel

Carbon Steel

Battery Valve

Ball Valve

Ball Valve Seat

Actuated Valve

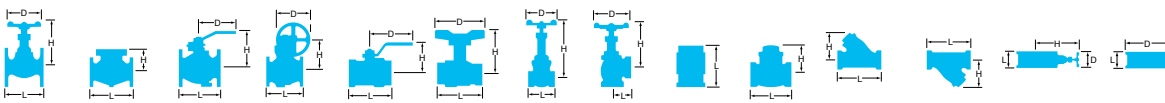

TYPE		FLOATING BALL			FLOATING BALL			FLOATING BALL			FLOATING BALL			FLOATING BALL			
Ball Valve																	
FIG		150UTDZ / G-150UTDZ			150UTDZ1H / G-150UTDZ1H			150UTDZ1HM / G-150UTDZ1HM			300UTDZ1H			300UTDZ1HM			
PRESSURE		Class 150			Class 150			Class 150			Class 300			Class 300			
END CONNECTION		ASME B16.5			ASME B16.5			ASME B16.5			ASME B16.5			ASME B16.5			
DIMENSIONS	inch	mm	L	H	D	L	H	D	L	H	D	L	H	D	L	H	D
	1/2	15	108	108	130	108	108	130	108	108	130	140	108	130	140	108	130
	3/4	20	117	111	130	117	111	130	117	111	130	152	111	130	152	111	130
	1	25	127	124	160	127	124	160	127	124	160	165	124	160	165	124	160
	1 1/4	32	140	128	160	140	128	160	140	128	160	—	—	—	—	—	—
	1 1/2	40	165	134	230	165	134	230	165	134	230	190	134	230	190	134	230
	2	50	178	143	230	178	143	230	178	143	230	216	143	230	216	143	230
	2 1/2	65	190	179	400	190	179	400	190	179	400	241	179	400	241	179	400
	3	80	203	189	400	203	189	400	203	189	400	283	189	400	283	189	400
	4	100	229	251	750	229	251	750	229	251	750	—	—	—	—	—	—
	5	125	356	274	310	356	274	310	356	274	310	—	—	—	—	—	—
	6	150	394	335	360	394	335	360	394	335	360	—	—	—	—	—	—
	8	200	457	409	500	457	409	500	457	409	500	—	—	—	—	—	—
	10	250	533	456	500	533	456	500	533	456	500	—	—	—	—	—	—
BODY		A351 Gr.CF8			A351 Gr.CF8			A351 Gr.CF8M			A351 Gr.CF8			A351 Gr.CF8M			
BONNET		A351 Gr.CF8			A351 Gr.CF8			A351 Gr.CF8M			A351 Gr.CF8			A351 Gr.CF8M			
STEM		A276 TYPE304			A276 TYPE304			A276 TYPE316			A276 TYPE304			A276 TYPE316			
DISC		A276 TYPE304 / A351 Gr.CF8			A276 TYPE304 / A351 Gr.CF8			A276 TYPE316 / A351 Gr.CF8M			A276 TYPE304 / A351 Gr.CF8			A276 TYPE316 / A351 Gr.CF8M			
SEAT		HYPATITE PTFE			FILLTITE PTFE			FILLTITE PTFE			FILLTITE PTFE			FILLTITE PTFE			
		Full Port SIZE:5-8 Gear operation type			Full Port SIZE:5-8 Gear operation type			FILLTITE PTFE SIZE:5-8 Gear operation type			Full Port			Full Port			

TYPE		FLOATING BALL			FLOATING BALL			FLOATING BALL			FLOATING BALL			FLOATING BALL			
Ball Valve																	
FIG		150UTDZ3H / G-150UTDZ3H			150UTDZ3HM / G-150UTDZ3HM			300UTDZ3H / G-300UTDZ3H			300UTDZ3HM / G-300UTDZ3HM			150UTDZ5H / G-150UTDZ5H			
PRESSURE		Class 150			Class 150			Class 300			Class 300			Class 150			
END CONNECTION		ASME B16.5			ASME B16.5			ASME B16.5			ASME B16.5			ASME B16.5			
DIMENSIONS	inch	mm	L	H	D	L	H	D	L	H	D	L	H	D	L	H	D
	1/2	15	108	108	130	108	108	130	140	108	130	140	108	130	108	108	130
	3/4	20	117	111	130	117	111	130	152	111	130	152	111	130	117	111	130
	1	25	127	124	160	127	124	160	165	124	160	165	124	160	127	124	160
	1 1/4	32	140	128	160	140	128	160	—	—	—	—	—	—	140	128	160
	1 1/2	40	165	134	230	165	134	230	190	139	600	190	139	600	165	134	230
	2	50	178	148	300	178	148	300	216	148	600	216	148	600	178	148	300
	2 1/2	65	190	209	600	190	209	600	241	209	1000	241	209	1000	190	209	600
	3	80	203	219	600	203	219	600	283	219	1000	283	219	1000	203	219	600
	4	100	229	251	1000	229	251	1000	305	286	360	305	286	360	229	251	1000
	5	125	356	274	310	356	274	310	—	—	—	—	—	—	356	302	360
	6	150	394	335	360	394	335	360	403	360	500	403	360	500	394	335	360
	8	200	457	417	500	457	417	500	502	489	500	502	489	500	457	417	500
BODY		A351 Gr.CF8			A351 Gr.CF8M			A351 Gr.CF8			A351 Gr.CF8M			SCS13A			
BONNET		A351 Gr.CF8			A351 Gr.CF8M			A351 Gr.CF8			A351 Gr.CF8M			A351 Gr.CF8			
STEM		A276 TYPE304			A276 TYPE316			A276 TYPE304			A276 TYPE316			(JIS G4303 SUS630)			
DISC		A276 TYPE304			A276 TYPE316			A276 TYPE304			A276 TYPE316			A276 TYPE316+Cr PLATING			
SEAT		CARBON+(JIS SUS329J1)			CARBON+(JIS SUS329J1)			CARBON+(JIS SUS329J1)			CARBON+(JIS SUS329J1)			A276 TYPE316+Ni-Cr ALLOY			
		Full Port SIZE:5-8 Gear operation type			Full Port SIZE:5-8 Gear operation type			Full Port SIZE:5-8 Gear operation type			Full Port SIZE:4-8 Gear operation type			Full Port SIZE:5-8 Gear operation type			



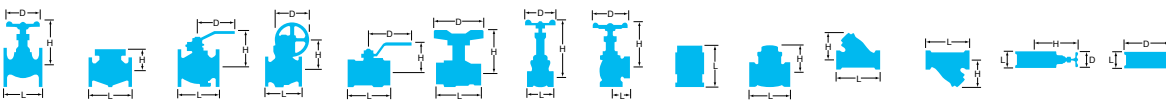

TYPE		FLOATING BALL					FLOATING BALL			FLOATING BALL			FLOATING BALL			FLOATING BALL		
Ball Valve																		
FIG		150UTDZ5HM / G-150UTDZ5HM					300UTDZ5H / G-300UTDZ5H			300UTDZ5HM / G-300UTDZ5HM			150UTDZ6H / G-150UTDZ6H			150UTDZ6HM / G-150UTDZ6HM		
PRESSURE		Class 150					Class 300			Class 300			Class 150			Class 150		
END CONNECTION		ASME B16.5					ASME B16.5			ASME B16.5			ASME B16.5			ASME B16.5		
DIMENSIONS		inch	mm	L	H	D	L	H	D	L	H	D	L	H	D	L	H	D
		1/2	15	108	108	130	140	108	130	140	108	130	108	108	130	108	108	130
		3/4	20	117	111	130	152	111	130	152	111	130	117	111	130	117	111	130
		1	25	127	124	160	165	124	160	165	124	160	127	124	160	127	124	160
		1 1/4	32	140	128	160	—	—	—	—	—	—	140	128	160	140	128	160
		1 1/2	40	165	134	230	190	139	600	190	139	600	165	134	230	165	134	230
		2	50	178	148	300	216	148	600	216	148	600	178	148	300	178	148	300
		2 1/2	65	190	209	600	241	209	1000	241	209	1000	190	209	600	190	209	600
		3	80	203	219	600	283	219	1000	283	219	1000	203	219	600	203	219	600
		4	100	229	251	1000	305	286	360	305	286	360	229	251	1000	229	251	1000
		5	125	356	302	360	—	—	—	—	—	—	356	302	360	356	302	360
		6	150	394	335	360	403	360	500	403	360	500	394	335	360	394	335	360
		8	200	457	417	500	502	489	500	502	489	500	457	417	500	457	417	500
BODY		SCS14A					SCS13A			SCS14A			A351 Gr.CF8			A351 Gr.CF8M		
BONNET		A351 Gr.CF8M					A351 Gr.CF8			A351 Gr.CF8M			A351 Gr.CF8			A351 Gr.CF8M		
STEM		(JIS G4303 SUS630)					(JIS G4303 SUS630)			(JIS G4303 SUS630)			(JIS G4303 SUS630)			(JIS G4303 SUS630)		
DISC		A276 TYPE316+Cr PLATING					A276 TYPE316+Cr PLATING			A276 TYPE316+Cr PLATING			A276 TYPE316+Cr PLATING			A276 TYPE316+Cr PLATING		
SEAT		A276 TYPE316+Ni-Cr ALLOY					A276 TYPE316+Ni-Cr ALLOY			A276 TYPE316+Ni-Cr ALLOY			A276 TYPE316+Ni-Cr ALLOY			A276 TYPE316+Ni-Cr ALLOY		
		Full Port SIZE:5-8 Gear operation type					Full Port SIZE:4-8 Gear operation type			Full Port SIZE:4-8 Gear operation type			Full Port SIZE:5-8 Gear operation type			Full Port SIZE:5-8 Gear operation type		

TYPE		FLOATING BALL					FLOATING BALL			FLOATING BALL			FLOATING BALL		
Ball Valve															
FIG		300UTDZ6H / G-300UTDZ6H					300UTDZ6HM / G-300UTDZ6HM			150UTDZXL / G-150UTDZXL			300UTDZXL / G-300UTDZXL		
PRESSURE		Class 300					Class 300			Class 150			Class 300		
END CONNECTION		ASME B16.5					ASME B16.5			ASME B16.5			ASME B16.5		
DIMENSIONS		inch	mm	L	H	D	L	H	D	L	H	D	L	H	D
		1/2	15	140	108	130	140	108	130	108	228	130	140	228	130
		3/4	20	152	111	130	152	111	130	117	231	130	152	231	130
		1	25	165	124	160	165	124	160	127	268	160	165	268	160
		1 1/4	32	—	—	—	—	—	—	140	272	160	—	—	—
		1 1/2	40	190	139	600	190	139	600	165	300	230	190	300	230
		2	50	216	148	600	216	148	600	178	309	230	216	309	230
		2 1/2	65	241	209	1000	241	209	1000	190	373	400	241	373	400
		3	80	283	219	1000	283	219	1000	203	383	400	283	383	400
		4	100	305	286	360	305	286	360	229	258	750	305	466	310
		5	125	—	—	—	—	—	—	356	482	310	—	—	—
		6	150	403	360	500	403	360	500	394	572	360	403	569	500
		8	200	502	489	500	502	489	500	457	685	500	502	685	500
		10	250	—	—	—	—	—	—	533	724	500	—	—	—
BODY		A351 Gr.CF8					A351 Gr.CF8M			A351 Gr.CF8			A351 Gr.CF8		
BONNET		A351 Gr.CF8					A351 Gr.CF8M			A351 Gr.CF8			A351 Gr.CF8		
STEM		(JIS G4303 SUS630)					(JIS G4303 SUS630)			A276 TYPE304			A276 TYPE304		
DISC		A276 TYPE316+Cr PLATING					A276 TYPE316+Cr PLATING			A351 Gr.CF8			A276 TYPE304 / A351 Gr.CF8		
SEAT		A276 TYPE316+Ni-Cr ALLOY					A276 TYPE316+Ni-Cr ALLOY			HYPATITE PTFE			HYPATITE PTFE		
		Full Port SIZE:4-8 Gear operation type					Full Port SIZE:4-8 Gear operation type			Full Port SIZE:5-10 Gear operation type			Full Port SIZE:4-8 Gear operation type		

Brass & Bronze

Cast Iron

Ductile Iron

Stainless Steel

Carbon Steel

Battery Valve

Ball Valve

Ball Valve Seat



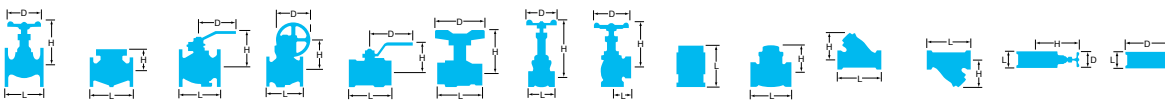

Actuated Valve

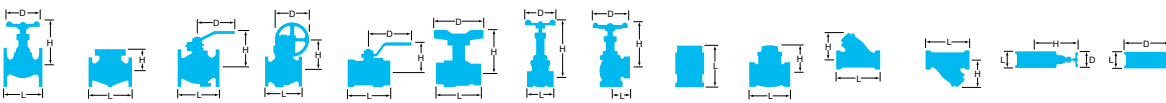

TYPE		FLOATING BALL					FLOATING BALL			FLOATING BALL			FLOATING BALL			FLOATING BALL		
Ball Valve																		
FIG		SCTK					10SCTDZ			20SCTDZ			150SCTDZ / G-150SCTDZ			150SCTDZM		
PRESSURE		Class 600					10K			20K			Class 150			Class 150		
END CONNECTION		BS21 (JIS B0203)					JIS B2220			JIS B2220			ASME B16.5			ASME B16.5		
DIMENSIONS	inch	mm	L	H	D	L	H	D	L	H	D	L	H	D	L	H	D	
	1/4	8	39	31	60	—	—	—	—	—	—	—	—	—	—	—	—	
	3/8	10	44	36	70	—	—	—	—	—	—	—	—	—	—	—	—	
	1/2	15	56.5	39	85	108	108	130	140	108	130	108	108	130	108	108	130	
	3/4	20	59	43	85	117	111	130	152	111	130	117	111	130	117	111	130	
	1	25	71	48	100	127	124	160	165	124	160	127	124	160	127	124	160	
	1 1/4	32	78	53	100	—	—	—	—	—	—	—	—	—	—	—	—	
	1 1/2	40	83	62	125	165	134	230	190	134	230	165	134	230	165	134	230	
	2	50	100	70	125	178	143	230	216	143	230	178	143	230	178	143	230	
	2 1/2	65	—	—	—	190	179	400	241	179	400	190	179	400	190	179	400	
	3	80	—	—	—	203	189	400	283	189	400	203	189	400	203	189	400	
	4	100	—	—	—	229	224	460	305	251	750	229	224	460	229	224	460	
	5	125	—	—	—	356	240	460	381	267	750	356	240	460	356	240	460	
	6	150	—	—	—	394	315	1000	403	315	1000	394	315	1000	394	315	1000	
	8	200	—	—	—	457	406	1500	502	406	1500	457	406	1500	457	406	1500	
	10	250	—	—	—	—	—	—	—	—	—	533	448	500	—	—	—	
BODY		SCPH2 (WCB)					SCPH2 (WCB)			SCPH2 (WCB)			A216 Gr.WCB			A216 Gr.WCB		
BONNET		—					SCPH2			SCPH2			A216 Gr.WCB			A216 Gr.WCB		
STEM		SUS316 / SUS304					SUS304			SUS304			A276 TYPE304			A276 TYPE316		
DISC		SUS316 / SUS304					SUS304 / SCS13A			SUS304 / SCS13A			A276 TYPE304 / A351 Gr.CF8			A276 TYPE316 / A351 Gr.CF8M		
SEAT		G/F PTFE					HYPATITE PTFE			HYPATITE PTFE			HYPATITE PTFE			HYPATITE PTFE		
		Reduced Port					Full Port			Full Port			Full Port SIZE:10 Gear operation type			Full Port		

TYPE		FLOATING BALL					FLOATING BALL			FLOATING BALL			FLOATING BALL			FLOATING BALL		
Ball Valve																		
FIG		300SCTDZ					300SCTDZM			10SCTDZ1H			20SCTDZ1H / G-20SCTDZ1H			150SCTDZ1H / G-150SCTDZ1H		
PRESSURE		Class 300					Class 300			10K			20K			Class 150		
END CONNECTION		ASME B16.5					ASME B16.5			JIS B2220			JIS B2220			ASME B16.5		
DIMENSIONS	inch	mm	L	H	D	L	H	D	L	H	D	L	H	D	L	H	D	
	1/2	15	140	108	130	140	108	130	108	108	130	140	108	130	108	108	130	
	3/4	20	152	111	130	152	111	130	117	111	130	152	111	130	117	111	130	
	1	25	165	124	160	165	124	160	127	124	160	165	124	160	127	124	160	
	1 1/2	40	190	134	230	190	134	230	165	134	230	190	134	230	165	134	230	
	2	50	216	143	230	216	143	230	178	143	230	216	143	230	178	143	230	
	2 1/2	65	241	179	400	241	179	400	190	179	400	241	179	400	190	179	400	
	3	80	283	189	400	283	189	400	203	189	400	283	189	400	203	189	400	
	4	100	305	251	750	305	251	750	229	251	750	305	258	310	229	251	750	
	5	125	—	—	—	—	—	—	—	—	—	381	302	360	356	274	310	
	6	150	403	315	1000	403	315	1000	—	—	—	403	332	500	394	335	360	
	8	200	502	406	1500	502	406	1500	—	—	—	502	417	500	457	409	500	
	10	250	—	—	—	—	—	—	—	—	—	—	—	—	533	456	500	
BODY		A216 Gr.WCB					A216 Gr.WCB			SCPH2 (WCB)			SCPH2 (WCB)			A216 Gr.WCB		
BONNET		A216 Gr.WCB					A216 Gr.WCB			SCPH2			SCPH2			A216 Gr.WCB		
STEM		A276 TYPE304					A276 TYPE316			SUS304			SUS304			A276 TYPE304		
DISC		A276 TYPE304 / A351 Gr.CF8					A276 TYPE316 / A351 Gr.CF8M			SUS304 / SCS13A			SUS304 / SCS13A			A276 TYPE304 / A351 Gr.CF8		
SEAT		HYPATITE PTFE					HYPATITE PTFE			FILLTITE PTFE			FILLTITE PTFE			FILLTITE PTFE		
		Full Port					Full Port			Full Port			Full Port SIZE:100-200 Gear operation type			Full Port SIZE:5-10 Gear operation type		



TYPE		FLOATING BALL					FLOATING BALL			FLOATING BALL			FLOATING BALL			FLOATING BALL		
Ball Valve																		
FIG		300SCTDZ1H / G-300SCTDZ1H					10SCTDZ3H / G-10SCTDZ3H			20SCTDZ3H / G-20SCTDZ3H			150SCTDZ3H / G-150SCTDZ3H			300SCTDZ3H / G-300SCTDZ3H		
PRESSURE		Class 300					10K			20K			Class 150			Class 300		
END CONNECTION		ASME B16.5					JIS B2220			JIS B2220			ASME B16.5			ASME B16.5		
DIMENSIONS		inch	mm	L	H	D	L	H	D	L	H	D	L	H	D	L	H	D
		1/2	15	140	108	130	108	108	130	140	108	130	108	108	130	140	108	130
		3/4	20	152	111	130	117	111	130	152	111	130	117	111	130	152	111	130
		1	25	165	124	160	127	124	160	165	124	160	127	124	160	165	124	160
		1 1/2	40	190	134	230	165	134	230	190	139	600	165	134	230	190	139	600
		2	50	216	143	230	178	148	300	216	148	600	178	148	300	216	148	600
		2 1/2	65	241	179	400	190	209	600	241	209	1000	190	209	600	241	209	1000
		3	80	283	189	400	203	219	600	283	219	1000	203	219	600	283	219	1000
		4	100	305	258	310	229	251	1000	305	286	360	229	251	1000	305	286	360
		5	125	—	—	—	356	274	310	381	302	360	356	274	310	—	—	—
		6	150	403	332	500	394	335	360	403	360	500	394	335	360	403	360	500
		8	200	502	417	500	457	417	500	502	489	500	457	417	500	502	489	500
BODY		A216 Gr.WCB					SCPH2 (WCB)			SCPH2 (WCB)			A216 Gr.WCB			A216 Gr.WCB		
BONNET		A216 Gr.WCB					SCPH2			SCPH2			A216 Gr.WCB			A216 Gr.WCB		
STEM		A276 TYPE304					SUS304			SUS304			A276 TYPE304			A276 TYPE304		
DISC		A276 TYPE304 / A351 Gr.CF8					SUS304			SUS304			A276 TYPE304			A276 TYPE304		
SEAT		FILLTITE PTFE					CARBON+329J1			CARBON+329J1			CARBON+(JIS SUS329J1)			CARBON+(JIS SUS329J1)		
		Full Port SIZE:4-8 Gear operation type					Full Port SIZE:125-200 Gear operation type			Full Port SIZE:100-200 Gear operation type			Full Port SIZE:5-8 Gear operation type			Full Port SIZE:4-8 Gear operation type		

TYPE		FLOATING BALL					FLOATING BALL			FLOATING BALL			FLOATING BALL			FLOATING BALL		
Ball Valve																		
FIG		10SCTDZ5H / G-10SCTDZ5H					20SCTDZ5H / G-20SCTDZ5H			150SCTDZ5H / G-150SCTDZ5H			300SCTDZ5H / G-300SCTDZ5H			10SCTDZ6H / G-10SCTDZ6H		
PRESSURE		10K					20K			Class 150			Class 300			10K		
END CONNECTION		JIS B2220					JIS B2220			ASME B16.5			ASME B16.5			JIS B2220		
DIMENSIONS		inch	mm	L	H	D	L	H	D	L	H	D	L	H	D	L	H	D
		1/2	15	108	108	130	140	108	130	108	108	130	140	108	130	108	108	130
		3/4	20	117	111	130	152	111	130	117	111	130	152	111	130	117	111	130
		1	25	127	124	160	165	124	160	127	124	160	165	124	160	127	124	160
		1 1/2	40	165	134	230	190	139	600	165	134	230	190	139	600	165	134	230
		2	50	178	148	300	216	148	600	178	148	300	216	148	600	178	148	300
		2 1/2	65	190	209	600	241	209	1000	190	209	600	241	209	1000	190	209	600
		3	80	203	219	600	283	219	1000	203	219	600	283	219	1000	203	219	600
		4	100	229	251	1000	305	286	360	229	251	1000	305	286	360	229	251	1000
		5	125	356	302	360	381	299	500	356	302	360	—	—	—	356	302	360
		6	150	394	335	360	403	360	500	394	335	360	403	360	500	394	335	360
		8	200	457	417	500	502	489	500	457	417	500	502	489	500	457	417	500
BODY		SCPH2 (WCB)					SCPH2 (WCB)			A216 Gr.WCB			A216 Gr.WCB			SCPH2 (WCB)		
BONNET		SCPH2					SCPH2			A216 Gr.WCB			A216 Gr.WCB			SCPH2		
STEM		SUS630					SUS630			(JIS G4303 SUS630)			A276 TYPE304			SUS630		
DISC		SUS316+Cr PLATING					SUS316+Cr PLATING			A276 TYPE316+Cr PLATING			A276 TYPE304			SUS316+Ni-Cr ALLOY		
SEAT		SUS316+Ni-Cr ALLOY					SUS316+Ni-Cr ALLOY			A276 TYPE316+Ni-Cr ALLOY			CARBON+(JIS SUS329J1)			SUS316+Ni-Cr ALLOY		
		Full Port SIZE:125-200 Gear operation type					Full Port SIZE:100-200 Gear operation type			Full Port SIZE:5-8 Gear operation type			Full Port SIZE:4-8 Gear operation type			Full Port SIZE:125-200 Gear operation type		



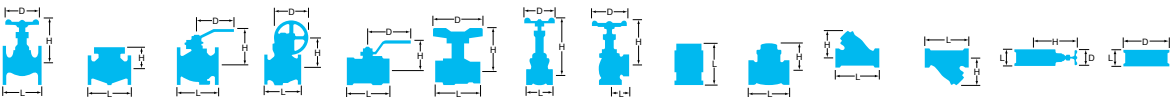

Brass & Bronze  
Cast Iron  
Ductile Iron  
Stainless Steel  
Carbon Steel  
Battery Valve  
Ball Valve  
Ball Valve Seat  
Actuated Valve







TYPE		FLOATING BALL			FLOATING BALL			FLOATING BALL			
Ball Valve											
FIG		20SCTDZ6H / G-20SCTDZ6H			150SCTDZ6H / G-150SCTDZ6H			300SCTDZ6H / G-300SCTDZ6H			
PRESSURE		20K			Class 150			Class 300			
END CONNECTION		JIS B2220			ASME B16.5			ASME B16.5			
DIMENSIONS	inch	mm	L	H	D	L	H	D	L	H	D
	1/2	15	140	108	130	108	108	130	140	108	130
	3/4	20	152	111	130	117	111	130	152	111	130
	1	25	165	124	160	127	124	160	165	124	160
	1 1/2	40	190	139	600	165	134	230	190	139	600
	2	50	216	148	600	178	148	300	216	148	600
	2 1/2	65	241	209	1000	190	209	600	241	209	1000
	3	80	283	219	1000	203	219	600	283	219	1000
	4	100	305	286	360	229	251	1000	305	286	360
	5	125	381	299	500	356	302	360	—	—	—
	6	150	403	360	500	394	335	360	403	360	500
	8	200	502	489	500	457	417	500	502	489	500
BODY		SCPH2 (WCB)			A216 Gr.WCB			A216 Gr.WCB			
BONNET		SCPH2			A216 Gr.WCB			A216 Gr.WCB			
STEM		SUS630			(JIS G4303 SUS630)			(JIS G4303 SUS630)			
DISC		SUS316+Ni-Cr ALLOY			A276 TYPE316+Cr PLATING			A276 TYPE316+Cr PLATING			
SEAT		SUS316+Ni-Cr ALLOY			A276 TYPE316+Ni-Cr ALLOY			A276 TYPE316+Ni-Cr ALLOY			
		Full Port SIZE:100-200 Gear operation type			Full Port SIZE:5-8 Gear operation type			Full Port SIZE:4-8 Gear operation type			

# BALL VALVE SEAT

# Ball Valve Seat

TYPE	PTFE	Hypatite PTFE	C/F PTFE	FILLTITE® (1H)
	Polytetrafluoroethylene resin	Hypatite Polytetrafluoroethylene resin	Carbon fiber filled Polytetrafluoroethylene resin	Polytetrafluoroethylene resin with carbon based special filler
<b>BALL VALVE SEAT</b>				
	<ul style="list-style-type: none"> <li>PTFE seats possess high chemical resistance and excellent sealing performance</li> </ul>	<ul style="list-style-type: none"> <li>Hypatite seats are made of modified PTFE.</li> <li>Hypatite seats has an excellent resistance to creep or compression and abrasion service, featuring of high elasticity and resilience. Hypatite seats also have good chemical resistance, so they can be used for as widerange of chemicals as PTFE.</li> <li>* Hypatite PTFE® is a registered trademark of KITZ Corporation.</li> </ul>	<ul style="list-style-type: none"> <li>This ball seat is made of PTFE reinforced with carbon.</li> <li>The seat has high mechanical strength and abrasion resistance.</li> </ul>	<ul style="list-style-type: none"> <li>FILLTITE® seats can be used at a temperature as high as 300°C, the highest service temperature among PTFE based ball seats.</li> </ul> <p>The ball seats are used in Class JIS 10K · 20K / ASME Class 150 · 300 ductile iron, stainless steel and carbon steel floating ball valves.</p>
	<p>The ball seats are used in</p> <p>bronze, brass and cast iron floating ball valves</p> <p>Maximum Service Temperature: 200°C</p>	<p>The ball seats are used in</p> <p>Class JIS 10K · 20K / ASME Class150 · 300 ductile iron, stainless steel and carbon steel floating ball valves.</p> <p>Maximum Service Temperature: 270°C</p>	<p>The ball seats are used in</p> <p>Class JIS 10K · 20K / ASME Class 150 · 300 ductile iron, stainless steel and carbon steel floating ball valves.</p> <p>Maximum Service Temperature: 270°C</p>	<p>The ball seats are used in</p> <p>Class JIS 10K · 20K / ASME Class 150 · 300 ductile iron, stainless steel and carbon steel floating ball valves.</p> <p><b>Maximum allowable seat leakage</b></p> <ul style="list-style-type: none"> <li>For oil-free valves: ANSI /FCI 70-2 Class VI. (Test media, Air)</li> </ul> <p>Maximum Service Temperature: 300°C</p>

TYPE	CARBOTITE (3H)	Metal seat (5H)	Metal seat (6H)	SWELLESS seat	PEEK seat
	Hard carbon	Hard faced metal seat	Hard faced metal seat		Polyetheretherketone resin
<b>BALL VALVE SEAT</b>					
	<ul style="list-style-type: none"> <li>CARBOTITE seats are made of hard carbon with excellent heat resistance. Maximum service temperature is 500°C. The leakage may increase when valves are exposed to an oxidized service at a higher temperature than 450°C for extended periods</li> </ul>	<ul style="list-style-type: none"> <li>The surface of the 316 stainless steel seats is hard faced by thermal-spraying with nickel and chrome alloys for 300°C high temperature service.</li> <li>The seat has high abrasion resistance so that it can handle fluids including foreign particles.</li> </ul>	<ul style="list-style-type: none"> <li>The ball and ball seat surfaces are hard faced by thermal-spraying with nickel and chrome alloys, which enables valves to be used at a temperature of 500°C.</li> <li>Valves with the 6H seats are excellent in high abrasion and high temperature services so that they can be used for fluids including foreign particles and application of heated steam.</li> </ul>	<ul style="list-style-type: none"> <li>SWELLESS seats have excellent resistance to the permeation of monomer, such as Styrene or Butadiene, into the molecular structure of the ball seat materials, which is known as a "swelling" problem.</li> <li>Excellent sealing performance, operability and chemical resistance have been achieved by using fluoride resin as the base for the ball seat.</li> </ul>	<ul style="list-style-type: none"> <li>PEEK seats have high mechanical strength at a wide range of temperatures.</li> <li>The seat has excellent heat and chemical resistance, conforming with the requirements of UL94-V0 for its flame retardancy</li> </ul>
	<p>The ball seats are used in</p> <p>Class JIS 10K · 20K / ASME Class 150 · 300 stainless steel and carbon steel floating ball valves.</p> <p><b>Maximum allowable seat leakage</b></p> <p>ANSI /FCI 70-2 Class VI. (Test media, Air)</p> <p>Maximum Service Temperature: 500°C</p>	<p>The ball seats are used in</p> <p>Class JIS 10K · 20K / ASME Class 150 · 300 stainless steel and carbon steel floating ball valves.</p> <p><b>Maximum allowable seat leakage</b></p> <ul style="list-style-type: none"> <li>ANSI /FCI 70-2 Class VI. (Test media, Air)</li> <li>For oil-free valves:21.75ml/min. x port diameter (inch) x differential pressure (MPa)</li> </ul> <p>Maximum Service Temperature: 300°C</p>	<p>The ball seats are used in</p> <p>Class JIS 10K · 20K / ASME Class 150 · 300 stainless steel and carbon steel floating ball valves.</p> <p><b>Maximum allowable seat leakage</b></p> <ul style="list-style-type: none"> <li>ANSI /FCI 70-2 Class VI. (Test media, Air)</li> <li>For oil-free valves:21.75ml/min. x port diameter (inch) x differential pressure (MPa)</li> </ul> <p>Maximum Service Temperature: 500°C</p>	<p>The ball seats are used in</p> <p>Class JIS 10K · 20K / ASME Class 150 · 300 stainless steel and carbon steel floating ball valves.</p> <p>Maximum Service Temperature: 260°C</p>	<p>The ball seats are used in</p> <p>Class ASME Class 150 · 300 stainless steel and carbon steel floating and trunnion mounted ball valves.</p> <p>Maximum Service Temperature: 270°C</p>

# ACTUATED VALVE

# KITZ 10K Compact Ball Valves

## Valve design features

- Convenient size range from ¼" through 2".
- Integral actuator mounting pads enabling easy mounting or dismantling of actuators for speedy maintenance.
- Tight contact between PTFE ball seats and high precision machined balls for leakage-free service.
- Stems, made of high strength brass, are used for long service life.
- Choice of materials: Stainless steel for corrosion resistant service, or brass and bronze for general W.O.G. service.

## Valve design specifications

Threaded ends:	JIS B 0203
Union ends:	JIS B 2301
Maximum service pressure:	1.0MPa
	TKE, TKVE & TKSE for ¾" and larger, 5UTWE: 0.5MPa

## Ball valve design and applications

KITZ Fig.	JIS Material	Port	Bore*	Neck	End connection	Applications	Electric Actuator	Pneumatic Actuator
TE	CAC406	2-way	S.B.	Short	Threaded	On-off control of water, oil, and gas.	EA EAB EAL EALB ED** EAE***	Type C & CS (FBS)
TFE	C3771BE or CAC406		F.B.			Insulation for thermal isolation.		
TLE	CAC406	Horizontal 3-way	S.B.	Long		Instantaneous change of line fluid.		
TNE				Short		High temperature service.		
TGE		2-way	R.B.	Long	Male and female threaded with an union ring	Easy installation.		
TUE	TUE with insulation for thermal isolation.							
TLUE	Chrome plating C3771BE	Vertical 3-way	R.B.	Short	Threaded	On-off control of water, oil and gas. M5 tapped for panel mounting.	EC	Type C & CS
TKE						Instantaneous change of line fluid. (Free from concern of fluid mixing.)	ECS	
TKVE						On-off control of water, oil and gas. M5 tapped for panel mounting.	EAE***	
TKSE	CAC406	Vertical 3-way	S.B.	Short	Threaded	Instantaneous change of line fluid. (Free from concern of fluid mixing.)	EAH EAHB	Type C & CS (FBS)
TNVE						TE made of stainless steel.		
UTE	SCS14A	2-way	R.B.	Short	Threaded	TEE made of stainless steel.	EA EAB EAL EALB ED** EAE***	Type C & CS (FBS)
UTFE			F.B.			TNE made of stainless steel.		
UTNE		Horizontal 3-way	S.B.			TGE made of stainless steel.		
UTGE		R.B.	Wafer			Full bore wafer design. Maintenance ease.		
5/10UTWE	SCS13A	2-way	F.B.	Threaded	Integrally molded body. Instantaneous change of fluid. (Free from concern of fluid mixing.)	EAH EAHB		
UTVE	SCS14A	Vertical 3-way	R.B.					

\* Bore design: F.B.=Full bore, S.B.=Standard bore, R.B.=Reduced bore to API 608.

\*\* ED Series are available only for TE, TNE, UTE, UTFE, UTGE and 5/10UTWE ball valves.

\*\*\* EAE Series are available only for TE, TNE, TUE, TKSE and UTE ball valves.



## Applications

Automated on-off or 3-way flow control in HVAC service handling water, oil, gas and air (by brass and bronze valves) or in light load industrial processes for pharmaceutical, fine chemical, petro-chemical, food, beverage, textile and other general industries.

## Precautions

- ① No application to fluids including powders, dirt or sands.
- ② ● Fluid of high viscosity, steam or vacuum
  - Operational frequency higher than 10 times an hour
  - Velocity of 3 m/sec or faster
  - Service with concern of an extraordinary pressure rise of line fluid or a variation of fluid temperature higher than 80°C.
  - For voltages other than KITZ standard specification, contact KITZ or its local distributors for technical advice on application to:

## PTFE seat pressure-temperature ratings

### Valve: TE·TFE·TLE·TNE·TUE·TLUE UTE·UTFE·UTNE·5/10UTWE

- Fluid: water, oil, gas (unfrozen)
- Ball seat: PTFE (Standard)
- O-ring: FKM (Standard)

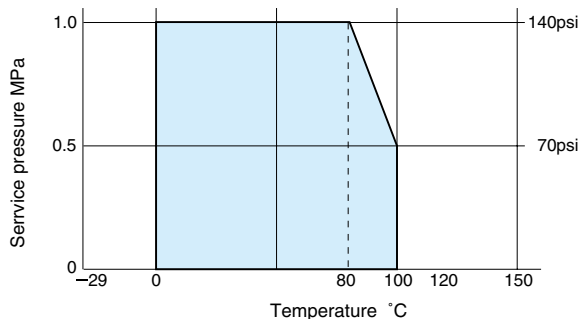

### Valve: TGE

- Fluid: water, oil or gas (unfrozen)
- Ball seat: reinforced PTFE
- Gland packing: Flexible graphite + PTFE braided packing

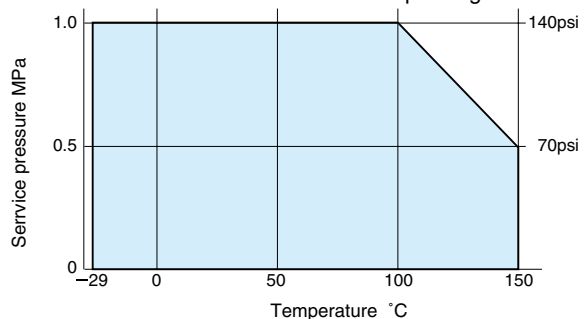

### Valve: TE·TFE·TLE·TNE·TUE·TLUE UTE·UTFE·UTNE·5/10UTWE

- Fluid: water, oil, gas (unfrozen) or saturated steam
- Ball seat: reinforced PTFE (Option\*)
- O-ring: FKM (Option\*)

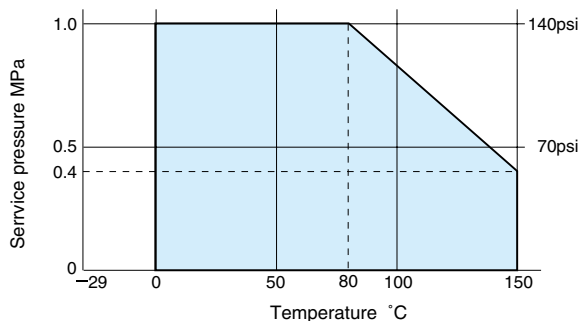

### Valve: UTGE

- Fluid: water, oil, gas (unfrozen)
- Ball seat: reinforced PTFE
- Gland packing: Flexible graphite + PTFE braided packing

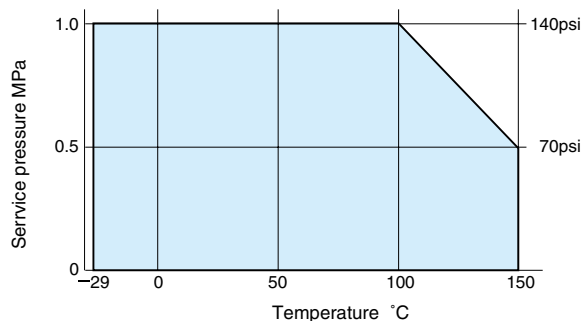

\* Specify these materials in your order for the P-T ratings covered by the graph shown above, except for 1½" and 2". Standard materials are only available for these sizes.

- Note:**
- Please refer to our website ([www.kitz.co.jp](http://www.kitz.co.jp)) or contact KITZ for PTFE pressure-temperature ratings of TKE, TKVE and TKSE.
  - Serviceable ambient temperature depends on the design of actuators. Refer to the information given for each of actuators introduced in this catalog.

# Actuated Valve

## KITZ 3-way Compact Ball Valves: Change of Flow Directional Form

KITZ horizontal 3-way ball valves are principally used for quick change of flow direction. Also 3-way ball valves can be used for simplification of piping systems as shown in Fig. 1.

KITZ Fig. TNE, TNVE, TKVE, UTNE and UTVE 3-way ball valves are provided with L-port and double face seating design for change of flow direction between Form 1 and 2. It should be noted that, if the line pressure of the closed bore is higher than that of the open bores, a small rate of fluid leakage may occur from the closed bore. (Fig. 2)

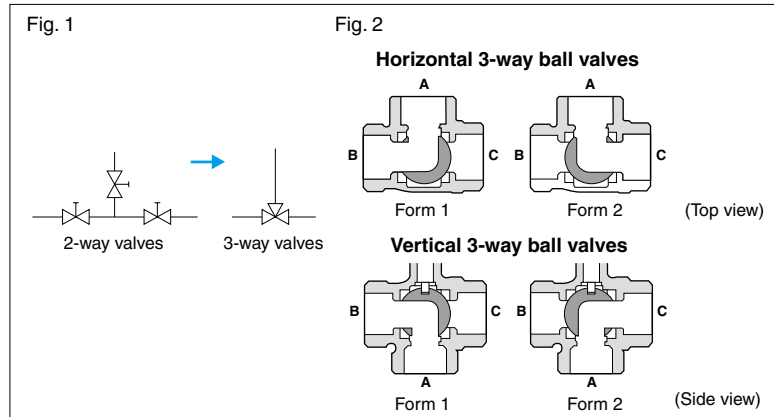

## KITZ 3-way Compact Ball Valves: Flow Directional Form

Shipment shall be made with the flow directional form fixed as illustrated here. (Fig. 3)

**Location of cord connectors** (top view):

Horizontal 3-way: Size 1 & 1.5: Right hand side  
 Size 2: Diagonally forward right  
 Vertical 3-way: Size 1: Right hand side  
 Size 2: Diagonally forward left

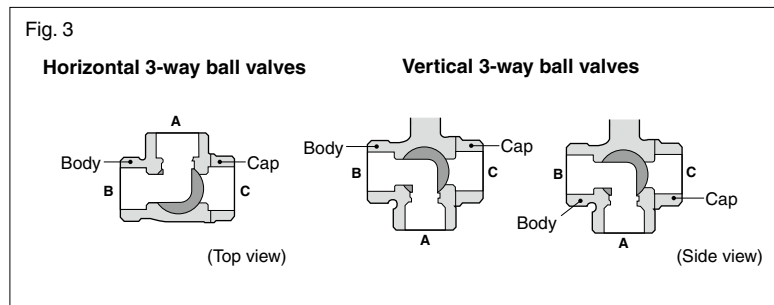

## KITZKELMO® Electric Actuators: EA and ED Series

### General design features

- Compact size and light weight with diecast aluminium housing and powerful miniature motor for economy and handling ease.
- Simple mechanism with minimized number of component parts for high durability and trouble-free service.
- Free from concerns common with conventional solenoid valves such as water hammer, pressure loss, malfunction caused by jammed valve interior, and restricted flow direction.
- All weather type design for outdoor service.
- Availability of manual operation in case of electric failure.
- Versatile applications by means of optional built-in relay circuit for parallel drive, terminal boxes and 180° rotary mechanism for 3-way flow direction.
- Safety provision to protect the motor from overheat damage caused by accidental overload.
- Factory-made actuator-to-valve assembly for off-the-shelf supply.

## KITZ KELMO® Electric Actuators

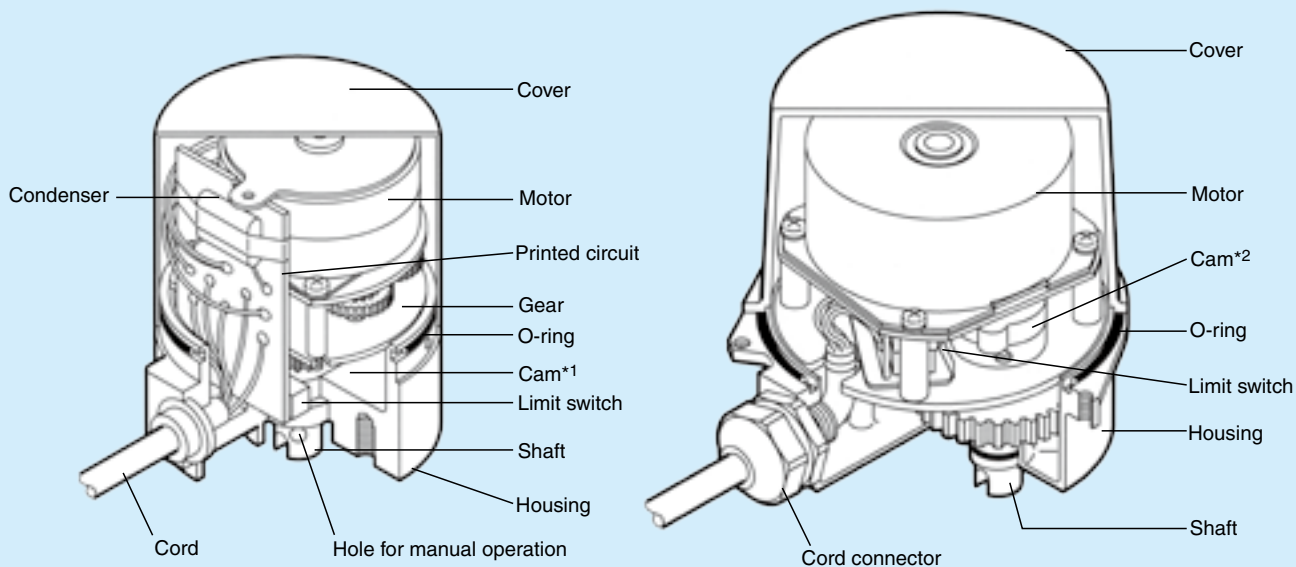

**Type EA100 / 200 Size 1 & 1.5**

\*1 Different cam design for Type EAH100 / 200-1

**Type EA100 / 200 Size 2**

\*2 Different cam design for Type EAH100 / 200-2

### Compact KELMO® actuators: power sources and functional features

Type of actuator		* Power source	Functional features
EA Series	EA100 / EA200	100V AC 200V AC (50Hz / 60Hz)	90°bi-directional rotation
	EAB100 / EAB200		90°bi-directional rotation / Terminal box
	EAL100 / EAL200		90°bi-directional rotation / Built-in relay
	EALB100 / EALB200		90°bi-directional rotation / Built-in relay / Terminal box
	EAH100 / EAH200		180°bi-directional rotation
	EAHB100 / EAHB200		180°bi-directional rotation / Terminal box
	EAE100 / EAE200		100V / 200V AC (50Hz / 60Hz)
ED Series	ED12 / ED24	12V / 24V DC	90°bi-directional rotation / Parallel drive

\* Optional Specification (EA Series)

110V AC (50/60HZ)

115V AC\* (50/60HZ)

120V AC (50/60HZ)

230V AC\* (50/60HZ)

240V AC (50/60HZ)

\* EA100/200-1 only

# Actuated Valve

## Type EA Electric Actuators / 10K Bronze or Stainless Steel Ball Valves

■ 90° bi-directional rotation

100V / 200V AC 50Hz / 60Hz

### Type EA actuator design specifications

Specification \ Type	EA100-1	EA200-1	EA100-1.5	EA200-1.5	EA100-2	EA200-2
Power source 50Hz / 60Hz	100V AC	200V AC	100V AC	200V AC	100V AC	200V AC
Rated current	90mA	50mA	90mA	50mA	100mA	50mA
Max. power consumption	9W	10W	9W	10W	10W	
Valve closing time 90°	50Hz	Approx.6 sec.		Approx.12 sec.		Approx.15 sec.
	60Hz	Approx.5 sec.		Approx.10 sec.		Approx.13 sec.
Max. output torque	1.9N·m		3.9N·m		9.8N·m	
Rated time	Continuous					
Insulation Class	JIS Class E					
Sensitive switch contact capacity	125V AC / 2A (Resistance load) 250V AC / 0.6A (Resistance load)				125V AC / 2A (Resistance load) 250V AC / 2A (Resistance load)	
Position limit switch	1 unit each for opening / closing (Using the same power source as that of the actuator)					
Insulation strength	1500V AC (1 min. interval)					
Insulation resistance	Minimum 10MΩ (500V DC)					
Standard protection	All weather type (for outdoor use, avoid sunlight)					
Ambient temperature	-20°C ~ +50°C					
Mounting position	Vertical to horizontal					
Wiring	Vinyl cabtyre cord with 5 cores, 700mm in length					
	0.3mm <sup>2</sup>				0.5mm <sup>2</sup>	
Lubrication	Grease					
Overload protection	Impedance protection					
Coating color	Housing: black Cover: light blue					

**Note:** Contact KITZ for technical advice when the service conditions differ from the above.

### Type EA actuator circuit diagrams (with the valve fully closed)

#### EA100 / 200 Size 1~2

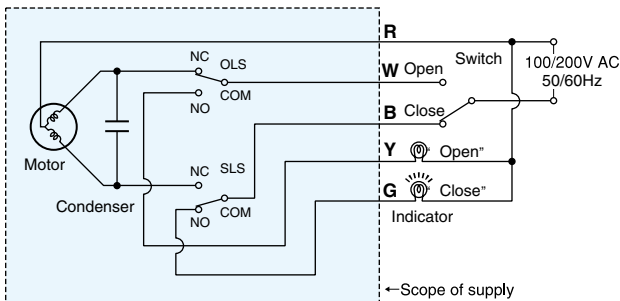

**Note:** For all sizes of Type EAB 100 / 200, the terminals are numbered 1, 2, 3, 4 and 5 in place of R, W, B, Y and G respectively.

● Wire color: **R** red **W** white **B** black **Y** yellow **G** green

● Actuator rotates:

**R-W:** counter-clockwise to fully open the valve

**R-B:** clockwise to fully close the valve

● Limit switches activate:

OLS: on fully opening the valve (R-W: off W-Y: on)

SLS: on fully closing the valve (R-B: off B-G: on)

**Note:** ●When two or more actuators are operated by a single switch, ensure to prevent unintended current flows by using relay contacts.

●Auxiliary devices, such as lamps or relays, where minute current is used, may cause failure in the contacts of limit switches. Consult KITZ for such applications.

## Type ED Electric Actuators / Class 10K Bronze or Stainless Steel Ball Valves

■ DC 12V or 24V for handy, on-the-spot automated valve operation

12V / 24V DC

### Type ED actuator design specifications

Specification \ Type	ED12-1	ED24-1	ED12-2	ED24-2
Power source 50Hz / 60Hz	12V DC	24V DC	12V DC	24V DC
Rated current	360mA	140mA	520mA	260mA
Starting current	0.4A	0.5A	1.9A	0.95A
Max. power consumption	5W	4W	9W	10W
Valve closing time 90° 50Hz	Approx. 5 sec.			
Max. output torque	1.4N·m		7.3N·m	
Rated time	5 min			
Insulation Class	JIS Class E			
Position limit switch	1 unit each for opening / closing (Using the same power source as that of the actuator)			
Insulation strength	250V DC (1 min. interval)		500V DC (1 min. interval)	
Insulation resistance	Minimum 10MΩ (250V DC)			
Standard protection	All weather type (for outdoor use)			
Ambient temperature	-20°C ~ +50°C			
Mounting position	Vertical to horizontal			
Wiring	Vinyl cabtyre cord with 5 cores		UL approved noninflammable cord with 5 cores	
	0.3mm <sup>2</sup>		0.5mm <sup>2</sup>	
Lubrication	Grease			
Overload protection	Impedance protection		Thermal protection	
Coating color	Housing: black Cover: light blue			

**Note:** Type ED12-2 and ED24-2 are optionally available for mobile application.  
Don't spray high pressure water directly to Type ED actuator during car wash.

### Type ED actuator circuit diagrams (with the valve fully closed)

#### ED 12 / 24 Size 1

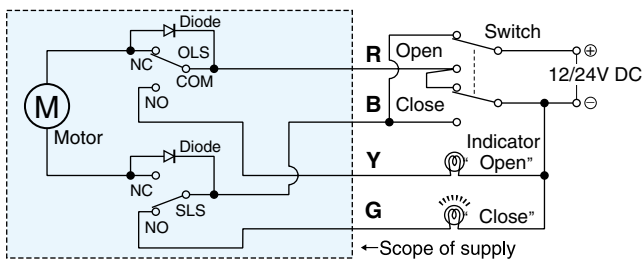

#### ED 12 / 24 Size 2

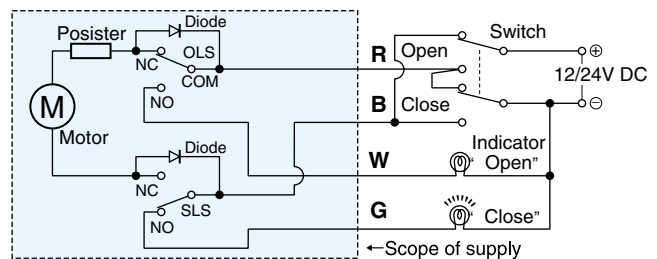

- Wire color: **R** red **W** white **B** black **Y** yellow **G** green
- Actuator rotates:
  - R**⊕ - **B**⊖: Counter-clockwise to fully open the valve
  - R**⊖ - **B**⊕: Clockwise to fully close the valve
- Limit switches activate:
  - OLS: on fully opening the valve (R-B: off R-Y(W): on)
  - SLS: on fully closing the valve (R-B: off B-G: on)

# Actuated Valve

The adoption of common parts and part modularization have enabled flexible modification, which will widen the applications of the actuator.

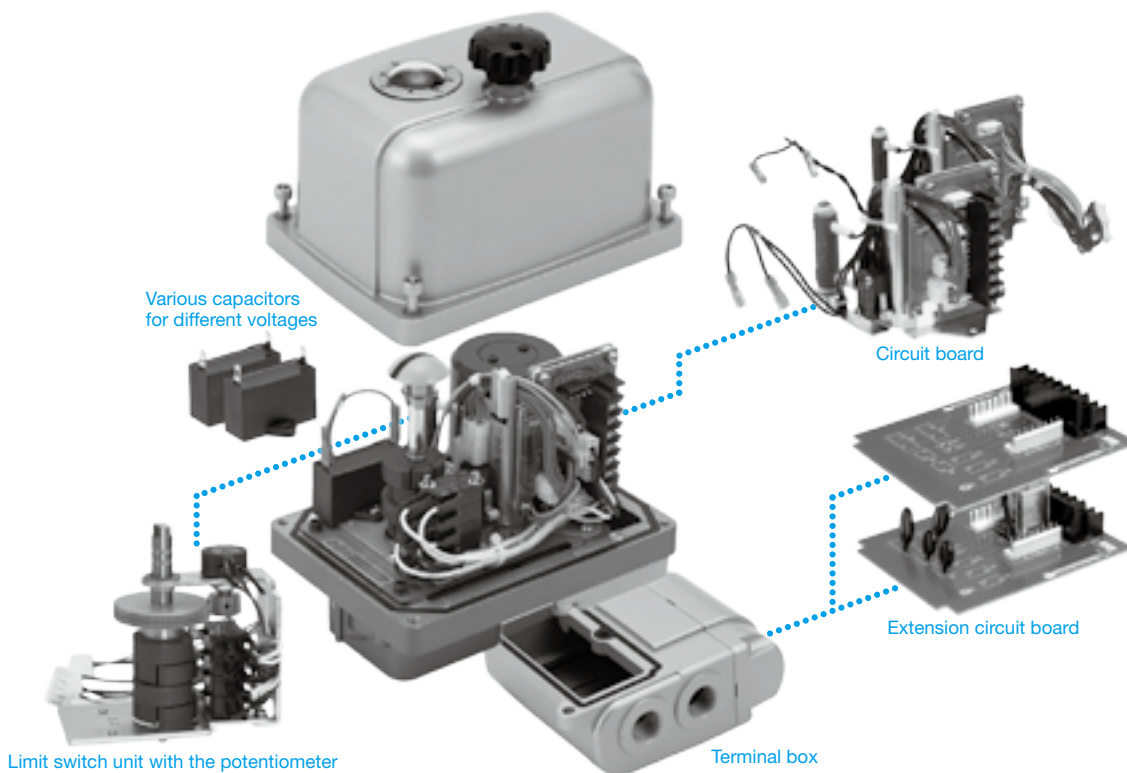

## Optional specification

### Power supply

**EXH | EXS**

AC110V 50/60Hz

AC115V 50/60Hz

AC120V 60Hz

AC220V 50/60Hz

AC230V 50/60Hz

AC240V 50Hz

AC115V 50Hz, AC120V 60Hz, AC230V 60Hz, AC240V  
Allowable fluctuation of supply voltage is limited within between minus 10% and plus 5% for 50Hz.

### Relays

**EXH | EXS**

Relays (on/off by a-contact) can be provided in the actuator by using extension circuit boards

### Limit switch specification

**EXH | EXS**

Contact for Micro load (Minute electrical current)  
Two standard limit switches can be replaced by optional limit switches for micro load (minute electrical current)

### Potentiometer output

**EXH | EXS**

135Ω (Coil type)

500Ω (Coil type)

The valve opening degree is indicated by resistance value.

### Auxiliary limit switch specification

**EXH | EXS**

Two more additional limit switches can be added.

Switches for micro load application are also available.

Including four standard limit switches, total six switches can be used. (In case the potentiometer is used, four limit switches in total can be used at maximum.)

### Terminal box

**EXH**

G1/2 two conduit ports

G3/4 one conduit port

NPT1/2 two conduit ports

NPT3/4 one conduit port

M20 one conduit port

Terminal box with two G1/2 conduit port is equipped as standard for EXS type.

For EXH type, the use of the terminal box will enable the actuator to connect cables without removing the cover and to extend the actuator functions by using optional circuit boards.

### Conduit port

**EXH | EXS**

G3/4, NPT1/2, NPT3/4, M20

Bronze & Brass  
Cast Iron  
Ductile Iron  
Stainless Steel  
Carbon Steel  
Butterfly Valve  
Ball Valve  
Ball Valve Seat  
Actuated Valve

## Specification

High-speed type For ball valve	EXH100/200-1	EXH100/200-2	EXH100/200-3	EXH100/200-4	EXH100/200-5
Standard-speed type For butterfly valve and ball valve	EXS100/200-2	EXS100/200-3	EXS100/200-4	EXS100/200-5	EXS100/200-5
Power Supply	100/200V AC ±10% 50/60Hz				
Output Torque (Nm)	9.8	49	196	588	1000
Rated Current (A) *1	100V AC	0.65	1.2	2.8	2.8
	200V AC	0.35	0.35	0.6	1.5
Motor Type	Reversible				
Motor Output (W) (Rating)	16	16	31	85	85
Rotating Direction *2	Tuning clockwise to close and counterclockwise to open valves				
Duty Factor [%ED]	30	30	30	30	30
Valve Closing Time [SEC] *3	EXH 50Hz	9	14	21	28
	EXH 60Hz	8	12	17	23
	EXS 50Hz	—	25	35	49
	EXS 60Hz	—	21	30	41
Space Heater Volume [W]	100V AC	15	15	15	15
	200V AC	15	15	15	15
Position Limit Switch *4	Two switches with voltage and two without voltage supplied				
Switch Contact Voltage	250V AC 11A least resistance load				
Insulation Class	JIS Class E, Strength: 1500V AC 1min. or 1800V 1sec., Resistance: 100Ω minimum at 500V DC				
Overload Protection	Thermal protection				
Service Environment	Indoor / Outdoor (Submergence and direct sunlight must be avoided.)				
Water, Dust — Proof	Equivalent to IP-67				
Ambient Temperature	-10°C ~ +50°C				
Conduit Port	EXH	One G1/2			
	EXS	Two G1/2			
Mounting Position	From Vertical position to Horizontal position (No downward position)				
Manual Operation	Pull up the manual override handle knob for manual operation, which will activate the built-in interlock switch to cut off power supply. For the restoration of electrical operation, push down the handle knob				
Mechanical Stopper	EXH	Mechanical stoppers are equipped in open and closed position. The stoppers are adjustable by 7 degrees in the both positions			
	EXS	Mechanical stoppers, which can be adjusted in the closed position, are equipped in open and closed position			
Position Indicator	Position indicator, covered by transparent cover, is equipped on the top of the actuator cover				
Mounting Flange	In accordance with ISO5211				

\*1 As the actuator is subjected to approx. tenfold rated current at startup, the contacts of electrical devices connected to the actuator must have enough capacity to handle this large electrical current.

\*2 Refer to "Operation manual" for 3 way valves.

\*3 Valve closing time is calculated based on an unloaded condition without the valve being mounted. The closing time will be 10% slower, when the valve is mounted.

\*4 In case load current is 50 mA or smaller, use limit switches for micro load (minute current).

## Circuit Diagram

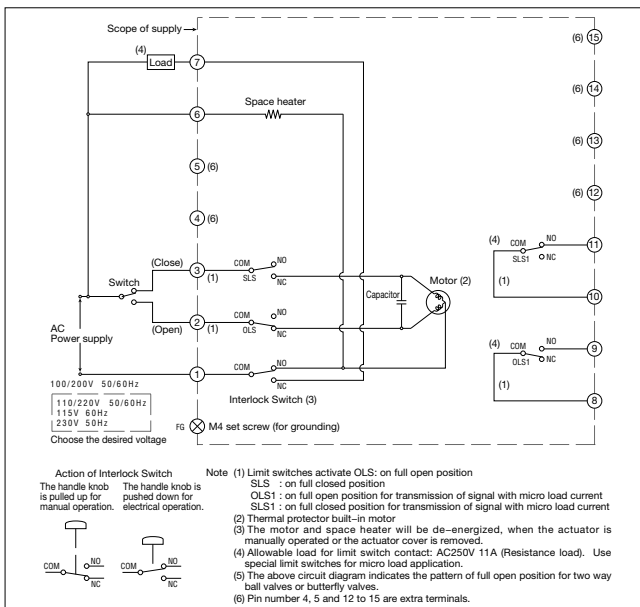

## Product Code

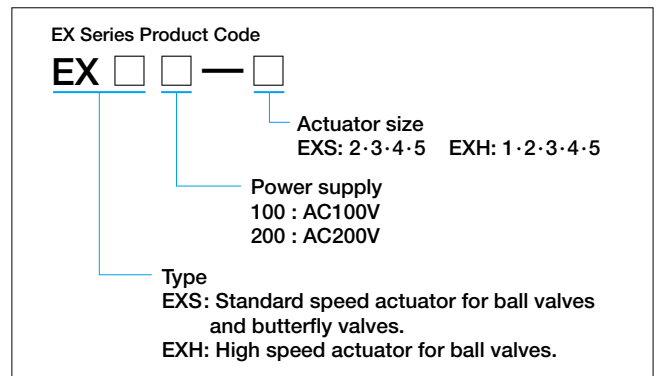

# Actuated Valve

## KITZ C-CS Series Pneumatic Actuators

Type C (Double action)

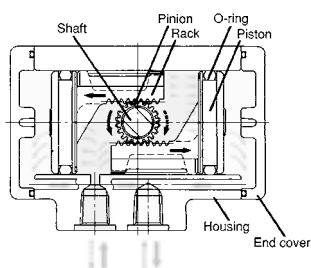

Type CS (Spring return)

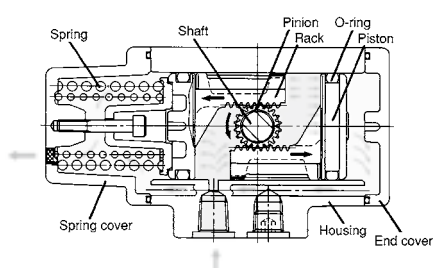

Type FBS (Spring return)

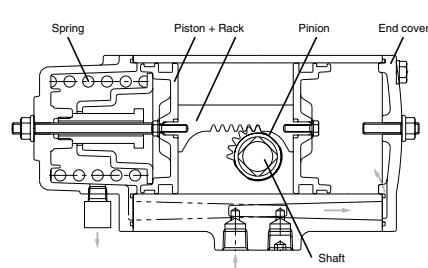

### Actuator design Specifications

Specification	Type	C-1	C-2	CS-1	CS-2	FBS-1
Operating media		Instrumentation air				
Standard operating pressure		0.39 MPa (60psi)				
Operating pressure range		0.39 ~ 0.69 MPa (60~100psi)				
Output torque*1		3.9 N-m	8.5 N-m	1.3 N-m	3.1 N-m	7.6 N-m
Housing shell test pressure		0.97 MPa (140psi)				
Angle of Revolution		90°(+1°~+5°)				90°±7°
Cylinder Volume (Litter)		0.073	0.160	0.033	0.071	0.15
Operation Time		Max. 1 sec.*4				
Service Temperature range*2		-20°C ~ +60°C -4°F ~ +140°F				-20°C ~ +80°C -4°F ~ +176°F
Ambient Condition*3		Indoor				

#### Notes:

\*1 At supply pressure, 0.39MPa

\*2 Free from freezing of supply air

\*3 For outdoor service, consult a KITZ Engineer

\*4 On a condition of KITZ standard air equipments and no load on a valve



## Design Features of KITZ C·CS /FBS Series Actuators

### ■ Lightweight and compact size

Die-casted aluminum body and double piston mechanism make the actuator lightweight and compact.

### ■ Simple mechanism and less malfunction

This actuator consists of minimum number of parts. That makes the actuator longer service life and less possibility of malfunction.

### ■ Special solenoid valve

Direct mount type special solenoid valve exclusively use for KITZ C type actuator is available.

### ■ High efficient quarter turn actuator

Double piston type rack and pinion mechanism provides high efficient quarter turn rotation.

### ■ Direct mount type

The actuator is directly mounted on a valve with only two bolts.

FBS type actuator should be chosen for bigger size valves.

### Standard guide actuator selection

Fig	Size	1/4	3/8	1/2	3/4	1	1 1/4	1 1/2	2
TE		C-1				CS-2			
		CS-1	CS-2			(FBS-1)			
TFE		C-1			C-2				
		CS-2	(FBS-1)						
TLE		C-1			C-2				
		CS-2			(FBS-1)				
TNE		C-1				C-2			
		CS-1	CS-2			(FBS-1)			
TGE		C-1	C-2						
		CS-2	(FBS-1)						
TUE		C-1			C-2				
		CS-2							
UTE		C-1				C-2			
		CS-1	CS-2			(FBS-1)			
UTFE		C-1			C-2				
		CS-2	(FBS-1)						
UTGE		C-1	C-2						
		CS-2	(FBS-1)						
5/10UTWE		C-1			C-2				
		CS-2			(FBS-1)				
UTNE		C-1				C-2			
		CS-1	CS-2			(FBS-1)			

For the size ranges not covered by KITZ C Series actuators, more powerful KITZ Type FBS-1 actuators are recommended.

# Features of KITZ B Series Pneumatic Actuators

## Type B (Double-Action)

Internationally patented

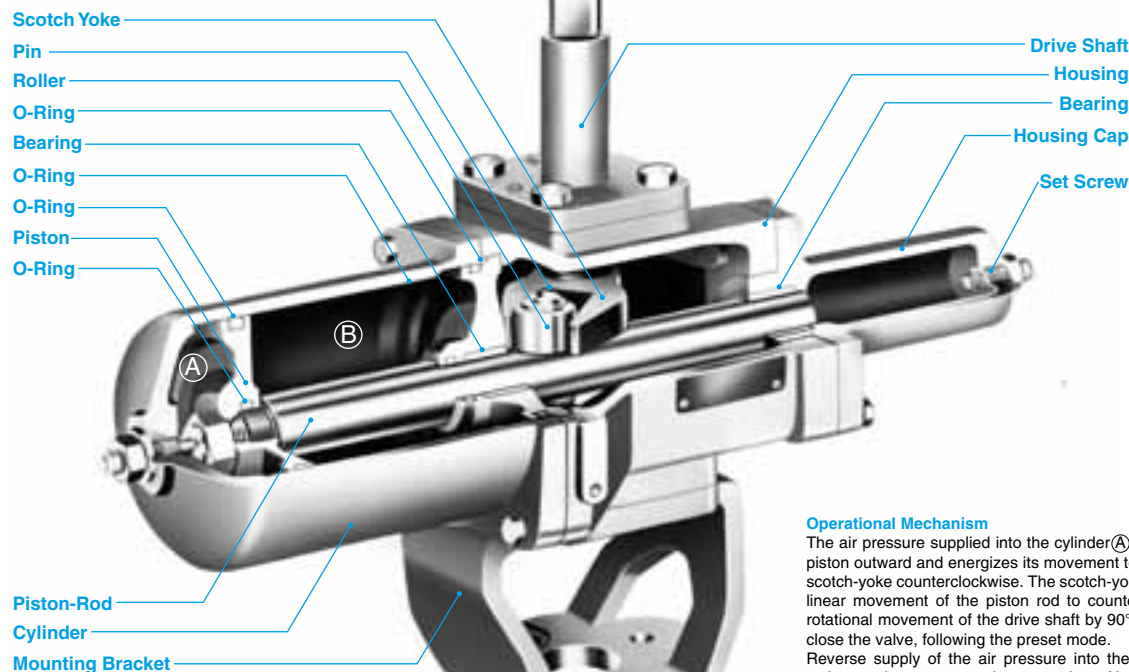

Note: For manual valve operation, a lever is mounted on the top end of the drive shaft of Type B-1 through B-4 actuators. Separate manual operators are available for Type B-5 and B-6 actuators.

### Operational Mechanism

The air pressure supplied into the cylinder (A) pushes the piston outward and energizes its movement to rotate the scotch-yoke counterclockwise. The scotch-yoke converts linear movement of the piston rod to counterclockwise rotational movement of the drive shaft by 90° to open or close the valve, following the preset mode. Reverse supply of the air pressure into the cylinder (B) activates the reverse valve operation. Air failure will cause the valve to stay at the position where the operation was disturbed, unlike the valve driven by Type BS or BWS actuator.

※Please contact KITZ Corporation for B-7.

### Smooth operation with minimum friction

Extensive use of fluorocarbon resin to coat inside parts of the actuator reduces friction to a minimum for smooth operation. This includes the inside of the cylinder, resulting in smooth sliding of the piston and O-rings, as well as the surfaces of driving shaft, piston rod, and all bearings. As a result, the actuator features long-term stable operation.

### Simple, trouble-free construction

The number of parts has been minimized to reduce mechanical problems and simplify periodic check, maintenance, disassembly, or reassembly.

### Separated turning mechanism and cylinder

Unlike conventional designs, in which the cylinder drive transmission mechanism is incorporated in the cylinder itself, the transmission mechanism of KITZ B Series actuators is designed with a scotch yoke installed separately from the cylinder.

This construction prevents air leakage even when the shaft clearance has increased during service.

### Drive characteristics suited to quarter-turn valves

Unlike conventional cylinder actuators deploying linear drive characteristics, use of a scotch yoke mechanism provides a U-shape curve which maximizes the force obtained at the start and end areas of each stroke. This performance curve is similar to the torque characteristics of ball and butterfly valves in general, making KITZ B Series actuators suitable for such quarter-turn valves (see Page 101).

### Installation of accessories

The actuator housing is provided with an arrangement for mounting limit switches and valve positioners, etc. on its top, and solenoid valves, air filters, and regulators on its side.

## Type BS (Spring-Return) Type BSW (Spring-Return with Manual Operation Device)

Internationally patented

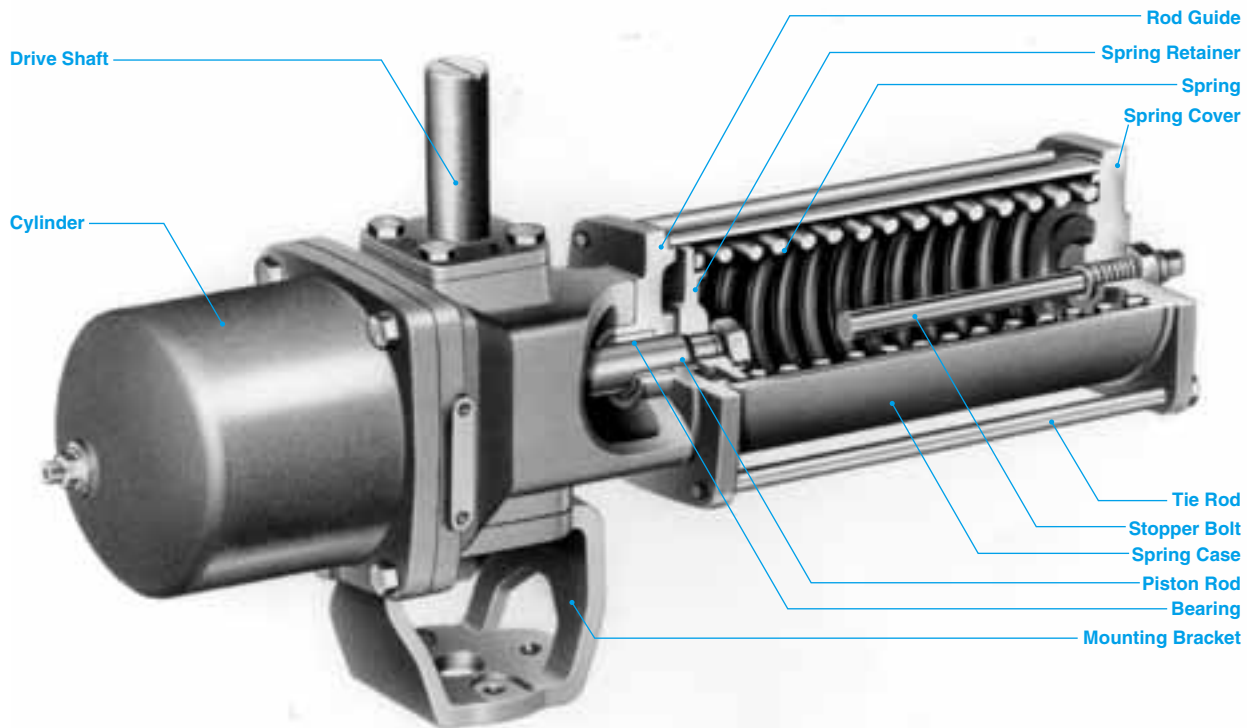

### Operational Mechanism

The air pressure supplied into the cylinder pushes the piston outward and energizes its movement to rotate the scotch-yoke counterclockwise, compressing the spring. The scotch-yoke converts linear movement of the piston rod to counterclockwise rotational movement of the drive shaft by 90°, to open or close the valve, following the preset mode. The BSW actuator is driven with the same mechanism as Type BS, but provided with a handwheel for manual operation. Please bear it in mind that the handwheel must be factory mounted.

At the moment the air is discharged to the atmosphere through the solenoid valve, the spring force pushes the piston to the reverse direction, and the scotch-yoke activates clockwise rotation of the shaft to reversely operate the valve. Air failure will cause the valve to return to the original open or closed position automatically, following the preset mode, unlike the valve driven by Type B actuator. The BSW actuator is driven with the same mechanism as Type BS, but provided with a handwheel for manual operation. Please bear it in mind that the handwheel must be factory mounted.

※Please contact KITZ Corporation for BS-7 and BSW-7.

Type B Actuator Output Torque

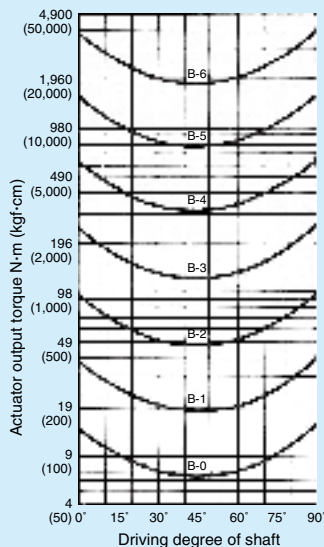

Type BS/BSW Actuator Output Torque

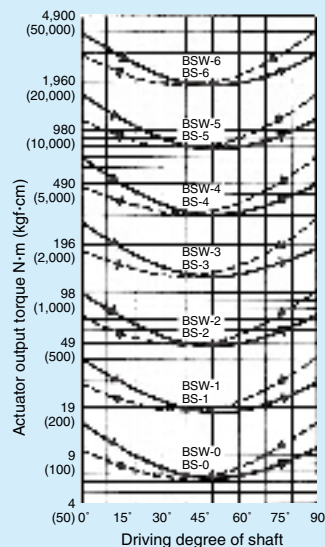

— Output torque when air pressure is supplied.  
- - - Output torque caused by spring force when air pressure is exhausted.

Operating pressure:  
0.4MPa (4kgf/cm<sup>2</sup> or 60psi)

※Please contact KITZ Corporation for B-7, BS-7 and BSW-7.

# KITZ F Series Pneumatic Valve Actuators

**Featured by the utmost handling ease and extended service life with high operational efficiency**

### Easy answers to engineering modification requirements

#### Economic advantage

Use of monobloc casting of piston-rack assembly results in reduced housing dimensions by 10% to 15% (compared with KITZ D Series actuators), and saves air consumption for valve actuation.

#### Extended service life with monobloc casting of two pistons and a gear-rack

Threads of a gear-rack is positioned in the center of actuator housing, and two pistons are cast in integration with gear-rack as one-piece unit. This helps to keep piston position in parallel during actuator travel.

#### Light and compact housing

Employment of diecast aluminum for housings and piston-rack assemblies has reduced the actuator weight by 20% to 40% (compared with KITZ D Series actuators) for better torque-to-weight ratio.

### Conformity to international standards

NAMUR VDI/VDE 3845 designs are used for tubeless mounting of solenoid valve and switchbox on actuator housing besides the conformity to ISO 5211 requirements for valve mounting flanges. The stem top design also conforms to NAMUR dimensions.

### Actuators can be directly mounted to KITZ DJ, XJ Series Butterfly Valves

### Optional adaptors (connectors) to the valves on the bottom of actuators can be provided for wide mounting variations

## Operating Mechanism

### Double action (Type FA)

- (1) Air pressure supplied into the chamber **A** through port ①, pushes gear rack with two pistons outward, and discharges the air residue through port ②.
- (2) The gear rack rotates the pinion gear and the shaft counter-clockwise, to drive the valve.
- (3) Reverse supply of the air pressure activates reverse valve operation.

### Spring return (Type FAS)

- (1) Air pressure supplied into the chamber **A** through port ①, pushes gear rack with two pistons outward, compresses the springs and discharges the air residue through port ②.
- (2) The gear rack rotates the pinion gear and the shaft counter-clockwise, to drive the valve.
- (3) At the moment the air in the chamber **A** is discharged through the solenoid valve, the spring force pushes the pistons to the reverse direction, and the gear rack activates rotation of the shaft clockwise to reversely operate the valve.

## Design Features

### Double Action Type FA

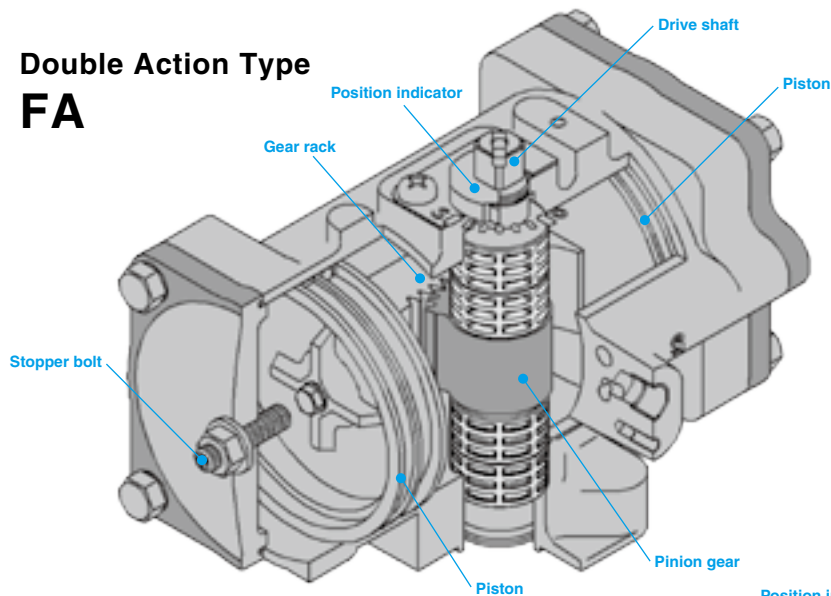

### Spring Return Type FAS

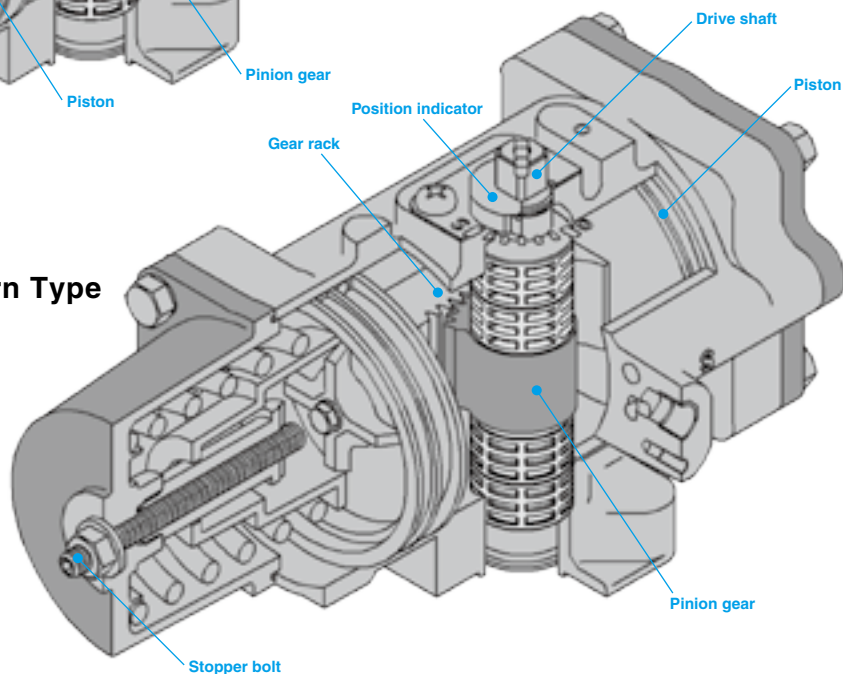

## Specification

Operating medium	Compressed instrumentation air or nitrogen gas
Operating pressure	Standard operating pressure 0.4 MPa
Operating pressure range	0.3 MPa to 0.7 MPa*
Cylinder test pressure	0.97 MPa
Shaft rotating angle	90°±7°
Service temperature	-20°C to +80°C (Supply air should not be frozen.)
Opening degree indication	Indicator has 15 degree graduation
Valve mounting flange	ISO 5211
Accessory mounting connection	NAMUR VDI/VDE 3845
Coating	Baked Polyester Resin Coating

\* Be consulted by KITZ for non-standard operating pressure.

## Product Coding

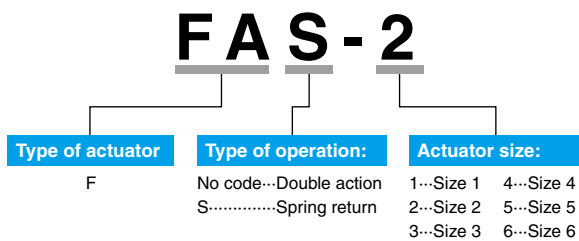



TYPE		FLOATING BALL			FLOATING BALL			FLOATING BALL			3WAY FLOATING BALL / 3WAY TRUNNION BALL			FLOATING BALL			
Actuators Valves																	
FIG		EA100/200-TE			EA100/200-TFE			EA100/200-TGE			EA100/200-TNE			EA100/200-UTE			
PRESSURE		10K			10K			10K			10K			10K			
END CONNECTION		BS21 (JIS B0203)			JIS B0203			JIS B0203			JIS B0203			JIS B0203			
DIMENSIONS	inch	mm	L	H	D	L	H	D	L	H	D	L	H	D	L	H	D
	1/4	8	—	—	—	—	—	—	—	—	—	46	101.5	—	44	102	—
	3/8	10	46	104	—	—	—	—	46	130	—	46	101.5	—	44	102	—
	1/2	15	65	109.5	—	63	113.5	—	65	135.5	—	67	109.5	—	56.5	102	—
	3/4	20	68	113.5	—	73	117.5	—	68	139.5	—	68	114	—	59	105	—
	1	25	79	117.5	—	85	128.5	—	79	143.5	—	79	118	—	71	108	—
	1 1/4	32	86	128.5	—	98	142.2	—	—	—	—	89	129.5	—	78	132.5	—
	1 1/2	40	96	142.5	—	108	148.5	—	—	—	—	100	142.5	—	83	135.5	—
	2	50	109	148.5	—	—	—	—	—	—	—	115	148.5	—	100	141.5	—
BODY		Cast Bronze			Forged Brass			Cast Bronze			Cast Bronze			SCS14A			
BONNET		Forged Brass			Forged Brass			Forged Brass			Forged Brass			—			
STEM		Special Brass			High Tension Brass			High Tension Brass			High Tension Brass			SUS316			
DISC		Special Brass			Special Brass			Special Brass			Special Brass			SUS316			
SEAT		PTFE			PTFE			REINFORCED PTFE			PTFE			PTFE			
		Reduced Port			Full Port			Reduced Port			Reduced Port			Reduced Port			

TYPE		FLOATING BALL			FLOATING BALL			3WAY FLOATING BALL			FLOATING BALL / TRUNNION BALL			3WAY FLOATING BALL / 3WAY TRUNNION BALL			
Actuators Valves																	
FIG		EA100/200-UTFE			EA100/200-UTGE			EA100/200-UTNE			ED12/24-TE			ED12/24-TNE			
PRESSURE		10K			10K			10K			10K			10K			
END CONNECTION		JIS B0203			JIS B0203			JIS B0203			BS21 (JIS B0203)			JIS B0203			
DIMENSIONS	inch	mm	L	H	D	L	H	D	L	H	D	L	H	D	L	H	D
	1/4	8	—	—	—	44	128	—	44	101.5	—	—	—	—	46	109.5	—
	3/8	10	—	—	—	44	128	—	44	101.5	—	46	112	—	46	109.5	—
	1/2	15	62	113.5	—	56.5	128	—	58	106.5	—	65	117.5	—	67	117.5	—
	3/4	20	73	117.5	—	59	131	—	61.5	110.5	—	68	121.5	—	68	122	—
	1	25	85	128.5	—	71	134	—	74	114	—	79	120.5	—	79	121	—
	1 1/4	32	98	143.5	—	—	—	—	82.5	132.5	—	86	124.5	—	89	125.5	—
	1 1/2	40	108	149	—	—	—	—	90.5	135.5	—	96	138.5	—	100	138.5	—
	2	50	—	—	—	—	—	—	109.5	141.5	—	109	144.5	—	115	144.5	—
BODY		SCS14A			SCS14A			SCS14A			Cast Bronze			Cast Bronze			
BONNET		SCS14A			—			—			Forged Brass			Forged Brass			
STEM		SUS316			SUS316			SUS316			Special Brass			High Tension Brass			
DISC		SUS316			SUS316			SUS316			Special Brass			Special Brass			
SEAT		PTFE			REINFORCED PTFE			C/F PTFE			PTFE			PTFE			
		Full Port			Reduced Port			Reduced Port			Reduced Port			Reduced Port			



TYPE		FLOATING BALL				FLOATING BALL / TRUNNION BALL				FLOATING BALL			
Actuators Valves													
FIG		ED12/24-UTE				ED12/24-UTFE				ED12/24-UTGE			
PRESSURE		10K				10K				10K			
END CONNECTION		JIS B0203				JIS B0203				JIS B0203			
DIMENSIONS	inch	mm	L	H	D	L	H	D	L	H	D		
	1/4	8	44	110	—	—	—	—	44	123.5	—		
	3/8	10	44	110	—	—	—	—	44	123.5	—		
	1/2	15	56.5	110	—	62	121.5	—	56.5	124	—		
	3/4	20	59	113	—	73	120.5	—	59	126.5	—		
	1	25	71	116	—	85	124.5	—	71	129.4	—		
	1 1/4	32	78	128.5	—	98	139.5	—	—	—	—		
	1 1/2	40	83	131.5	—	108	145.5	—	—	—	—		
	2	50	100	137.5	—	—	—	—	—	—	—		
BODY		SCS14A				SCS14A				SCS14A			
BONNET		—				SCS14A				—			
STEM		SUS316				SUS316				SUS316			
DISC		SUS316				SUS316				SUS316			
SEAT		PTFE				PTFE				REINFORCED PTFE			
		Reduced Port				Full Port				Reduced Port			

Brass & Bronze

Cast Iron

Ductile Iron

Stainless Steel

Carbon Steel



Butterfly Valve

Ball Valve

Ball Valve Seat

Actuated Valve



TYPE		BUTTERFLY			BUTTERFLY			BUTTERFLY			
Actuators Valves											
FIG		EXS100/200-10DJ			EXS100/200-10DJE			EXS100/200-10XJME			
PRESSURE		10K			10K			10K			
END CONNECTION		Wafer Type (JIS 5K,10K)			Wafer Type (JIS 5K,10K)			Wafer Type (JIS 5K,10K)			
DIMENSIONS	inch	mm	L	H	D	L	H	D	L	H	D
	1 1/2	40	—	—	—	—	—	—	33	309	—
	2	50	43	328	—	43	328	—	43	313	—
	2 1/2	65	46	336	—	46	336	—	46	322	—
	3	80	46	354	—	46	354	—	46	330	—
	4	100	52	364	—	52	364	—	52	341	—
	5	125	56	417.5	—	56	417.5	—	56	401	—
	6	150	56	429.5	—	56	429.5	—	56	413.5	—
	8	200	60	454.5	—	60	454.5	—	60	440	—
	10	250	68	580	—	68	580	—	68	604	—
	12	300	78	605	—	78	605	—	78	629	—
	14	350	78	717	—	78	717	—	—	—	—
	16	400	102	772	—	102	772	—	—	—	—
BODY		FCD450-10			FCD450-10			Aluminum Die-Cast			
BONNET		—			—			—			
STEM		SUS403 / SUS410			SUS403 / SUS410			SUS410			
DISC		FCD450-10+ENP			FCD450-10+ENP			A276 316 / A351 CF8M			
SEAT		NBR			EPDM / NBR			EPDM			
		Ductile iron (Ni-plated)			Ductile iron (Ni-plated)						





TYPE	FLOATING BALL / TRUNNION BALL					FLOATING BALL / TRUNNION BALL			FLOATING BALL			FLOATING BALL / TRUNNION BALL			3WAY FLOATING BALL / 3WAY TRUNNION BALL		
Actuators Valves																	
FIG	C-TE					C-TFE			C-TGE			C-TLE			C-TNE		
PRESSURE	10K					10K			10K			10K			10K		
END CONNECTION	BS21 (JIS B0203)					JIS B0203			JIS B0203			JIS B0203			JIS B0203		
DIMENSIONS	inch	mm	L	H	D	L	H	D	L	H	D	L	H	D	L	H	D
	1/4	8	-	-	-	-	-	-	-	-	-	-	-	-	46	85.5	-
	3/8	10	46	87.5	-	-	-	-	46	107.5	-	-	-	-	46	85.5	-
	1/2	15	65	93.5	-	63	97.5	-	65	132.5	-	56	115.5	-	67	93.5	-
	3/4	20	68	97.5	-	73	101.5	-	68	136.5	-	65	120.5	-	68	97.5	-
	1	25	79	101.5	-	85	124.5	-	79	140.5	-	78	123.5	-	79	101.5	-
	1 1/4	32	86	124.5	-	98	138.5	-	-	-	-	86	158.5	-	89	125.5	-
	1 1/2	40	96	137.5	-	108	144.5	-	-	-	-	96	161.5	-	100	138.5	-
2	50	109	144.5	-	-	-	-	-	-	-	109	168.5	-	115	144.5	-	
BODY	Cast Bronze					Forged Brass			Forged Brass			Cast Bronze			Forged Brass		
BONNET	Forged Brass					Forged Brass			Forged Brass			Cast Bronze			Forged Brass		
STEM	Special Brass					High Tension Brass			High Tension Brass			High Tension Brass			High Tension Brass		
DISC	Special Brass					Special Brass			Special Brass			Special Brass			Special Brass		
SEAT	PTFE					PTFE			REINFORCED PTFE			PTFE			PTFE		
	Reduced Port					Full Port			Reduced Port			Reduced Port			Reduced Port		

TYPE	FLOATING BALL					FLOATING BALL			FLOATING BALL			3WAY FLOATING BALL			FLOATING BALL		
Actuators Valves																	
FIG	C-UTE					C-UTE			C-UTGE			C-UTNE			CS-TE		
PRESSURE	10K					10K			10K			10K			10K		
END CONNECTION	JIS B0203					JIS B0203			JIS B0203			JIS B0203			BS21 (JIS B0203)		
DIMENSIONS	inch	mm	L	H	D	L	H	D	L	H	D	L	H	D	L	H	D
	1/4	8	-	-	-	44	85.5	-	44	105.5	-	44	85	-	-	-	-
	3/8	10	-	-	-	44	85.5	-	44	105.5	-	44	85	-	46	87.5	-
	1/2	15	78.5	85.5	-	56.5	85.5	-	56.5	124.5	-	58	90	-	65	112.5	-
	3/4	20	81	88.5	-	59	88.5	-	59	127.5	-	61.5	94	-	68	116.5	-
	1	25	-	-	-	71	91.5	-	71	130.5	-	74	97.5	-	79	120.5	-
	1 1/4	32	-	-	-	78	128.5	-	-	-	-	82.5	128	-	-	-	-
	1 1/2	40	-	-	-	83	131.5	-	-	-	-	90.5	131	-	-	-	-
2	50	-	-	-	100	137.5	-	-	-	-	109.5	137	-	-	-	-	
BODY	Cast Bronze					SCS14A			SCS14A			SCS14A			Cast Bronze		
BONNET	-					-			-			-			Forged Brass		
STEM	High Tension Brass					SUS316			SUS316			SUS316			Special Brass		
DISC	Special Brass					SUS316			SUS316			SUS316			Special Brass		
SEAT	G/F PTFE					PTFE			REINFORCED PTFE			C/F PTFE			PTFE		
	Reduced Port					Reduced Port			Reduced Port			Reduced Port			Reduced Port		

Brass & Bronze

Cast Iron

Ductile Iron

Stainless Steel

Carbon Steel





Battery Valve





Ball Valve

Ball Valve Seat

Actuated Valve



TYPE		FLOATING BALL			3WAY FLOATING BALL			FLOATING BALL			FLOATING BALL			FLOATING BALL			
Actuators Valves																	
FIG		CS-TLE			CS-TNE			CS-TUE			CS-UTE			CS-UTGE			
PRESSURE		10K			10K			10K			10K			10K			
END CONNECTION		JIS B0203			JIS B0203			JIS B0203			JIS B0203			JIS B0203			
DIMENSIONS	inch	mm	L	H	D	L	H	D	L	H	D	L	H	D	L	H	D
	1/4	8	—	—	—	46	85.5	—	—	—	—	44	85.5	—	44	124.5	—
	3/8	10	—	—	—	46	85.5	—	—	—	—	44	85.5	—	44	124.5	—
	1/2	15	56	134.5	—	67	112.5	—	78.5	104.5	—	56.5	104.5	—	—	—	—
	3/4	20	65	139.5	—	68	116.5	—	81	107.5	—	59	107.5	—	—	—	—
	1	25	78	142.5	—	79	120.5	—	—	—	—	71	110.5	—	—	—	—
	1 1/4	32	—	—	—	—	—	—	—	—	—	—	—	—	—	—	—
	1 1/2	40	—	—	—	—	—	—	—	—	—	—	—	—	—	—	—
	2	50	—	—	—	—	—	—	—	—	—	—	—	—	—	—	—
BODY		Cast Bronze			Cast Bronze			Cast Bronze			SCS14A			SCS14A			
BONNET		Cast Bronze			Forged Brass			—			—			—			
STEM		High Tension Brass			High Tension Brass			High Tension Brass			SUS316			SUS316			
DISC		Special Brass			Special Brass			Special Brass			SUS316			SUS316			
SEAT		PTFE			PTFE			G/F PTFE			PTFE			REINFORCED PTFE			
		Reduced Port			Reduced Port			Reduced Port			Reduced Port			Reduced Port			

TYPE		3WAY FLOATING BALL			FLOATING BALL			FLOATING BALL			3WAY FLOATING BALL			FLOATING BALL			
Actuators Valves																	
FIG		CS-UTNE			FA-10FCT			FA-10FCTB			FA-10FCTB2L			FA-10SCTDZ			
PRESSURE		10K			10K			10K			10K			10K			
END CONNECTION		JIS B0203			BS21 (JIS B0203)			JIS B2239			JIS B2239			JIS B2220			
DIMENSIONS	inch	mm	L	H	D	L	H	D	L	H	D	L	H	D	L	H	D
	1/4	8	44	85	—	—	—	—	—	—	—	—	—	—	—	—	—
	3/8	10	44	85	—	72	216	—	—	—	—	—	—	—	—	—	—
	1/2	15	58	109	—	80	225	—	110	225	—	—	—	108	215	—	—
	3/4	20	61.5	113	—	85	228	—	120	228	—	—	—	117	218	—	—
	1	25	74	116.5	—	95	235	—	130	235	—	—	—	127	240	—	—
	1 1/4	32	—	—	—	120	239	—	140	239	—	—	—	—	—	—	—
	1 1/2	40	—	—	—	120	297	—	165	297	—	210	297	—	165	297	—
	2	50	—	—	—	140	304	—	180	304	—	220	306	—	178	306	—
	2 1/2	65	—	—	—	160	349	—	190	345	—	250	347	—	190	363	—
	3	80	—	—	—	182	417	—	200	413	—	260	413	—	203	419	—
	4	100	—	—	—	—	—	—	230	436	—	330	440	—	229	447	—
	5	125	—	—	—	—	—	—	300	520	—	—	—	—	356	519	—
	6	150	—	—	—	—	—	—	340	545	—	—	—	—	394	552	—
	8	200	—	—	—	—	—	—	450	628	—	—	—	—	457	656	—
BODY		SCS14A			FC200			FC200			FC200			SCPH2 (WCB)			
BONNET		—			FC200			FC200			FC200			SCPH2			
STEM		SUS316			SUS403			SUS403			SUS403			SUS304			
DISC		SUS316			SUS304 / SCS13A			SUS304 / SCS13A			SCS13A			SUS304 / SCS13A			
SEAT		C/F PTFE			PTFE			PTFE			PTFE			HYPATITE PTFE			
		Reduced Port			Reduced Port			Full Port			Full Port			Full Port			



TYPE		FLOATING BALL					3WAY FLOATING BALL			3WAY FLOATING BALL			FLOATING BALL			FLOATING BALL		
Actuators Valves																		
FIG		FA-10UT					FA-10UTB2L			FA-10UTB4LAM			FA-10UTBLN			FA-10UTDZ		
PRESSURE		10K					10K			10K			10K			10K		
END CONNECTION		BS21 (JIS B0203)					JIS B2220			JIS B2220			JIS B2220			JIS B2220		
DIMENSIONS		inch	mm	L	H	D	L	H	D	L	H	D	L	H	D	L	H	D
		3/8	10	62	216	-	-	-	-	-	-	-	-	-	-	-	-	-
		1/2	15	65	225	-	-	-	-	120	237	-	140	228	-	108	215	-
		3/4	20	80	228	-	-	-	-	140	263	-	152	229	-	117	218	-
		1	25	90	235	-	165	235	-	160	267	-	165	240	-	127	240	-
		1 1/4	32	110	239	-	210	297	-	180	335	-	-	-	-	140	244	-
		1 1/2	40	120	297	-	220	304	-	200	403	-	191	301	-	165	297	-
		2	50	140	304	-	250	347	-	240	422	-	216	307	-	178	306	-
		2 1/2	65	160	345	-	260	413	-	260	498	-	240	347	-	190	363	-
		3	80	182	413	-	330	440	-	330	549	-	250	416	-	203	419	-
		4	100	-	-	-	-	-	-	-	-	-	280	442	-	229	447	-
		5	125	-	-	-	-	-	-	-	-	-	-	-	-	356	519	-
		6	150	-	-	-	-	-	-	-	-	-	-	-	-	394	552	-
		8	200	-	-	-	-	-	-	-	-	-	-	-	-	457	656	-
BODY		SCS13A					SCS13A			SCS14A			SCS13A			SCS13A		
BONNET		SCS13A					SCS13A			SCS14A			SCS13A			SCS13A		
STEM		SUS304					SUS304			SUS316			SUS304			SUS304		
DISC		SUS304 / SCS13A					SUS304 / SCS13A			SUS316 / SCS14A			SUS304 / SCS13A			SUS304 / SCS13A		
SEAT		PTFE					HYPATITE PTFE			HYPATITE PTFE			HYPATITE PTFE			HYPATITE PTFE		
		Full Port					Full Port			Full Port			Full Port			Full Port		

TYPE		FLOATING BALL					FLOATING BALL			FLOATING BALL			FLOATING BALL			FLOATING BALL		
Actuators Valves																		
FIG		FA-150SCTDZ					FA-150UTDZ			FA-20SCTDZ			FA-20UTDZ			FA-300SCTDZ		
PRESSURE		Class 150					Class 150			20K			20K			Class 300		
END CONNECTION		ASME B16.5					ASME B16.18			JIS B2220			JIS B2220			ASME B16.5		
DIMENSIONS		inch	mm	L	H	D	L	H	D	L	H	D	L	H	D	L	H	D
		1/2	15	108	215	-	108	215	-	108	215	-	140	215	-	140	215	-
		3/4	20	117	218	-	117	218	-	117	218	-	152	218	-	152	218	-
		1	25	127	240	-	127	240	-	127	240	-	165	240	-	165	240	-
		1 1/4	32	-	-	-	140	244	-	-	-	-	178	244	-	-	-	-
		1 1/2	40	165	297	-	165	297	-	165	297	-	190	297	-	190	297	-
		2	50	178	306	-	178	306	-	178	306	-	216	306	-	216	306	-
		2 1/2	65	190	363	-	190	363	-	190	363	-	241	363	-	241	363	-
		3	80	203	419	-	203	419	-	203	419	-	283	419	-	283	419	-
		4	100	229	447	-	229	447	-	229	447	-	305	447	-	305	447	-
		5	125	356	519	-	356	519	-	356	519	-	381	419	-	-	-	-
		6	150	394	552	-	394	552	-	394	552	-	403	552	-	403	552	-
		8	200	457	656	-	457	656	-	457	656	-	502	656	-	502	656	-
BODY		A216 Gr.WCB					A351 Gr.CF8			SCPH2 (WCB)			SCS13A			A216 Gr.WCB		
BONNET		A216 Gr.WCB					A351 Gr.CF8			SCPH2			SCS13A			A216 Gr.WCB		
STEM		A276 TYPE304					A276 TYPE304			SUS304			SUS304			A276 TYPE304		
DISC		A276 TYPE304 / A351 Gr.CF8					A276 TYPE304 / A351 Gr.CF8			SUS304 / SCS13A			SUS304 / SCS13A			A276 TYPE304 / A351 Gr.CF8		
SEAT		HYPATITE PTFE					HYPATITE PTFE			HYPATITE PTFE			HYPATITE PTFE			HYPATITE PTFE		
		Full Port					Full Port			Full Port			Full Port			Full Port		



TYPE		FLOATING BALL			FLOATING BALL			BUTTERFLY			BUTTERFLY			BUTTERFLY		
Actuators Valves																
FIG		FA-300UTDZ			FA-300UTDZM			FA-10XJME			FA-10DJ			FA-10DJE		
PRESSURE		Class 300			Class 300			10K			10K			10K		
END CONNECTION		ASME B16.18			ASME B16.18			Wafer Type (JIS 5K,10K)			Wafer Type (JIS 5K,10K)			Wafer Type (JIS 5K,10K)		
DIMENSIONS		inch	mm	L	H	D	L	H	D	L	H	D	L	H	D	
		1/2	15	140	215	—	140	215	—	—	—	—	—	—	—	
		3/4	20	152	218	—	152	218	—	—	—	—	—	—	—	
		1	25	165	240	—	165	240	—	—	—	—	—	—	—	
		1 1/4	32	—	—	—	—	—	—	—	—	—	—	—	—	
		1 1/2	40	190	297	—	190	297	—	33	251	—	—	—	—	
		2	50	216	306	—	216	306	—	43	255	—	43	270	—	
		2 1/2	65	241	363	—	241	363	—	46	287	—	46	278	—	
		3	80	283	419	—	283	419	—	46	295	—	46	319	—	
		4	100	305	447	—	305	447	—	52	306	—	52	329	—	
		5	125	—	—	—	—	—	—	56	357	—	56	373	—	
		6	150	403	552	—	403	552	—	56	369	—	56	385	—	
		8	200	502	656	—	502	656	—	60	435	—	60	449	—	
		10	250	—	—	—	—	—	—	68	573	—	68	549	—	
		12	300	—	—	—	—	—	—	78	627	—	78	603	—	
BODY		A351 Gr.CF8			A351 Gr.CF8M			Aluminum Die-Cast			FCD450-10			FCD450-10		
BONNET		A351 Gr.CF8			A351 Gr.CF8M			—			—			—		
STEM		A276 TYPE304			A276 TYPE316			SUS410			SUS403 / SUS410			SUS403 / SUS410		
DISC		A276 TYPE304 / A351 Gr.CF8			A276 TYPE316 / A351 Gr.CF8M			A276 316 / A351 CF8M			FCD450-10+ENP			FCD450-10+ENP		
SEAT		HYPATITE PTFE			HYPATITE PTFE			EPDM			NBR			EPDM		
		Full Port			Full Port						Ductile iron (Ni-plated)			Ductile iron (Ni-plated)		

TYPE		FLOATING BALL			FLOATING BALL			3WAY FLOATING BALL			FLOATING BALL			FLOATING BALL				
Actuators Valves																		
FIG		FAS-10FCT			FAS-10FCTB			FAS-10FCTB2L			FAS-10SCTDZ			FAS-10UT				
PRESSURE		10K			10K			10K			10K			10K				
END CONNECTION		BS21 (JIS B0203)			JIS B2239			JIS B2239			JIS B2220			BS21 (JIS B0203)				
DIMENSIONS		inch	mm	L	H	D	L	H	D	L	H	D	L	H	D			
		3/8	10	72	216	—	—	—	—	—	—	—	—	—	62	216	—	
		1/2	15	80	225	—	110	225	—	—	—	—	108	215	—	65	225	—
		3/4	20	85	228	—	120	228	—	—	—	—	117	241	—	80	228	—
		1	25	95	258	—	130	258	—	—	—	—	127	276	—	90	258	—
		1 1/4	32	120	262	—	140	262	—	—	—	—	—	—	—	110	262	—
		1 1/2	40	120	313	—	165	313	—	210	313	—	165	313	—	120	313	—
		2	50	140	343	—	180	343	—	220	345	—	178	355	—	140	343	—
		2 1/2	65	160	404	—	190	404	—	250	406	—	190	409	—	160	404	—
		3	80	182	468	—	200	468	—	260	468	—	203	475	—	182	468	—
		4	100	—	—	—	230	500	—	330	504	—	229	503	—	—	—	—
		5	125	—	—	—	300	549	—	—	—	—	356	548	—	—	—	—
		6	150	—	—	—	340	574	—	—	—	—	394	581	—	—	—	—
BODY		FC200			FC200			FC200			SCPH2 (WCB)			SCS13A				
BONNET		FC200			FC200			FC200			SCPH2			SCS13A				
STEM		SUS403			SUS403			SUS403			SUS304			SUS304				
DISC		SUS304 / SCS13A			SUS304 / SCS13A			SCS13A			SUS304 / SCS13A			SUS304 / SCS13A				
SEAT		PTFE			PTFE			PTFE			HYPATITE PTFE			PTFE				
		Reduced Port			Full Port			Full Port			Full Port			Full Port				



TYPE		3WAY FLOATING BALL				3WAY FLOATING BALL				FLOATING BALL			FLOATING BALL			FLOATING BALL		
Actuators Valves																		
FIG		FAS-10UTB2L				FAS-10UTB4LA				FAS-10UTBLN			FAS-10UTDZ			FAS-150SCTDZ		
PRESSURE		10K				10K				10K			10K			Class 150		
END CONNECTION		JIS B2220				JIS B2220				JIS B2220			JIS B2220			ASME B16.5		
DIMENSIONS	inch																	
	mm																	
	1/2	15	—	—	—	120	260	—	140	228	—	108	215	—	108	215	—	
	3/4	20	—	—	—	140	279	—	152	229	—	117	241	—	117	241	—	
	1	25	165	258	—	160	283	—	165	263	—	127	276	—	127	276	—	
	1 1/4	32	—	—	—	—	—	—	—	—	—	140	280	—	140	280	—	
	1 1/2	40	210	313	—	180	394	—	191	317	—	165	313	—	165	313	—	
	2	50	220	345	—	200	458	—	216	346	—	178	355	—	178	355	—	
	2 1/2	65	250	406	—	240	515	—	240	406	—	190	409	—	190	409	—	
3	80	260	468	—	260	527	—	250	471	—	203	475	—	203	475	—		
4	100	330	504	—	—	—	—	280	506	—	229	503	—	229	503	—		
5	125	—	—	—	—	—	—	—	—	—	356	548	—	356	548	—		
6	150	—	—	—	—	—	—	—	—	—	394	581	—	394	581	—		
BODY		SCS13A				SCS13A				SCS13A			SCS13A			A216 Gr.WCB		
BONNET		SCS13A				SCS13A				SCS13A			SCS13A			A216 Gr.WCB		
STEM		SUS304				SUS304				SUS304			SUS304			A276 TYPE304		
DISC		SUS304 / SCS13A				SUS304 / SCS13A				SUS304 / SCS13A			SUS304 / SCS13A			A276 TYPE304 / A351 Gr.CF8		
SEAT		HYPATITE PTFE				HYPATITE PTFE				HYPATITE PTFE			HYPATITE PTFE			HYPATITE PTFE		
		Full Port				Full Port				Full Port			Full Port			Full Port		

TYPE		FLOATING BALL				FLOATING BALL				FLOATING BALL			FLOATING BALL			FLOATING BALL		
Actuators Valves																		
FIG		FAS-150UTDZ				FAS-150UTDZM				FAS-20SCTDZ			FAS-20UTDZ			FAS-300SCTDZ		
PRESSURE		Class 150				Class 150				20K			20K			Class 300		
END CONNECTION		ASME B16.18				ASME B16.18				JIS B2220			JIS B2220			ASME B16.5		
DIMENSIONS	inch																	
	mm																	
	1/2	15	108	215	—	108	215	—	140	215	—	140	215	—	140	215	—	
	3/4	20	117	241	—	117	241	—	152	241	—	152	241	—	152	241	—	
	1	25	127	276	—	127	276	—	165	276	—	165	276	—	165	276	—	
	1 1/4	32	140	280	—	140	280	—	—	—	—	178	280	—	—	—	—	
	1 1/2	40	165	313	—	165	313	—	190	313	—	190	313	—	190	313	—	
	2	50	178	355	—	178	355	—	216	355	—	216	355	—	216	355	—	
	2 1/2	65	190	409	—	190	409	—	241	409	—	241	409	—	241	409	—	
3	80	203	475	—	203	475	—	283	475	—	283	475	—	283	475	—		
4	100	229	503	—	229	503	—	305	503	—	305	503	—	305	503	—		
5	125	356	548	—	356	548	—	381	548	—	381	548	—	381	548	—		
6	150	394	581	—	394	581	—	403	581	—	403	581	—	403	581	—		
BODY		A351 Gr.CF8				A351 Gr.CF8M				SCPH2 (WCB)			SCS13A			A216 Gr.WCB		
BONNET		A351 Gr.CF8				A351 Gr.CF8M				SCPH2			SCS13A			A216 Gr.WCB		
STEM		A276 TYPE304				A276 TYPE316				SUS304			SUS304			A276 TYPE304		
DISC		A276 TYPE304 / A351Gr.CF8				A276 TYPE316 / A351 Gr.CF8M				SUS304 / SCS13A			SUS304 / SCS13A			A276 TYPE304 / A351 Gr.CF8		
SEAT		HYPATITE PTFE				HYPATITE PTFE				HYPATITE PTFE			HYPATITE PTFE			HYPATITE PTFE		
		Full Port				Full Port				Full Port			Full Port			Full Port		

Bronze & Brass  
 Cast Iron  
 Ductile Iron  
 Stainless Steel  
 Carbon Steel  
 Battery Valve  
 Ball Valve  
 Ball Valve Seat  
 Actuated Valve

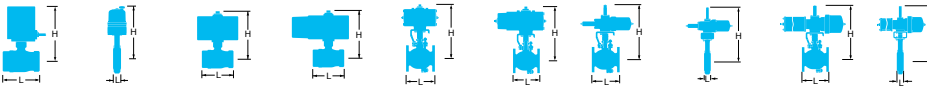

TYPE		FLOATING BALL			FLOATING BALL			BUTTERFLY			BUTTERFLY			BUTTERFLY			
Actuators Valves																	
FIG		FAS-300UTDZ			FAS-300UTDZM			FAS-10XJME			FAS-10DJ			FAS-10DJE			
PRESSURE		Class 300			Class 300			10K			10K			10K			
END CONNECTION		ASME B16.18			ASME B16.18			Wafer Type (JIS 5K,10K)			Wafer Type (JIS 5K,10K)			Wafer Type (JIS 5K,10K)			
DIMENSIONS	inch	mm	L	H	D	L	H	D	L	H	D	L	H	D	L	H	D
	1/2	15	140	215	—	140	215	—	—	—	—	—	—	—	—	—	—
	3/4	20	152	241	—	152	241	—	—	—	—	—	—	—	—	—	—
	1	25	165	276	—	165	276	—	—	—	—	—	—	—	—	—	—
	1 1/2	40	190	313	—	190	313	—	33	274	—	—	—	—	—	—	—
	2	50	216	355	—	216	355	—	43	278	—	43	293	—	43	293	—
	2 1/2	65	241	409	—	241	409	—	46	303	—	46	301	—	46	301	—
	3	80	283	475	—	283	475	—	46	311	—	46	335	—	46	335	—
	4	100	305	503	—	305	503	—	52	364	—	52	384	—	52	384	—
	5	125	—	—	—	—	—	—	56	396	—	56	412	—	56	412	—
	6	150	403	581	—	403	581	—	56	453	—	56	468	—	56	468	—
	8	200	—	—	—	—	—	—	60	511	—	60	522	—	60	522	—
	10	250	—	—	—	—	—	—	—	—	—	68	578	—	68	578	—
BODY		A351 Gr.CF8			A351 Gr.CF8M			Aluminum Die-Cast			FCD450-10			FCD450-10			
BONNET		A351 Gr.CF8			A351 Gr.CF8M			—			—			—			
STEM		A276 TYPE304			A276 TYPE316			SUS410			SUS403 / SUS410			SUS403 / SUS410			
DISC		A276 TYPE304 / A351 Gr.CF8			A276 TYPE316 / A351 Gr.CF8M			A276 316 / A351 CF8M			FCD450-10+ENP			FCD450-10+ENP			
SEAT		HYPATITE PTFE			HYPATITE PTFE			EPDM			NBR			EPDM			
		Full Port			Full Port						Ductile iron (Ni-plated)			Ductile iron (Ni-plated)			

TYPE		FLOATING BALL			FLOATING BALL			3WAY FLOATING BALL			FLOATING BALL			FLOATING BALL			
Actuators Valves																	
FIG		B-10FCT			B-10FCTB			B-10FCTB2L			B-10STLBF			B-10UT			
PRESSURE		10K			10K			10K			10K			10K			
END CONNECTION		BS21 (JIS B0203)			JIS B2239			JIS B2239			JIS B2239			BS21 (JIS B0203)			
DIMENSIONS	inch	mm	L	H	D	L	H	D	L	H	D	L	H	D	L	H	D
	3/8	10	72	202	—	—	—	—	—	—	—	—	—	—	62	202	—
	1/2	15	80	212	—	110	212	—	—	—	—	108	216	—	65	212	—
	3/4	20	85	215	—	120	215	—	—	—	—	117	219	—	80	215	—
	1	25	95	222	—	130	222	—	—	—	—	127	227	—	90	222	—
	1 1/4	32	120	298	—	140	298	—	—	—	—	140	302	—	110	298	—
	1 1/2	40	120	318	—	165	318	—	210	318	—	165	318	—	120	318	—
	2	50	140	365	—	180	365	—	220	367	—	178	365	—	140	365	—
	2 1/2	65	160	390	—	190	390	—	250	392	—	190	390	—	160	390	—
	3	80	182	464	—	200	464	—	260	464	—	203	464	—	182	464	—
	4	100	—	—	—	230	487	—	330	491	—	229	487	—	—	—	—
	5	125	—	—	—	300	600	—	—	—	—	356	600	—	—	—	—
	6	150	—	—	—	340	625	—	—	—	—	394	625	—	—	—	—
	8	200	—	—	—	450	712	—	—	—	—	457	712	—	—	—	—
	10	250	—	—	—	533	772	—	—	—	—	—	—	—	—	—	—
BODY		FC200			FC200			FC200			Ductile Iron			SCS13A			
BONNET		FC200			FC200			FC200			Ductile Iron			SCS13A			
STEM		SUS403			SUS403			SUS403			SUS403			SUS304			
DISC		SUS304 / SCS13A			SUS304 / SCS13A			SCS13A			SCS13A / SUS304			SUS304 / SCS13A			
SEAT		PTFE			PTFE			PTFE			PTFE			PTFE			
		Reduced Port			Full Port			Full Port			Full Port			Full Port			



TYPE	FLOATING BALL					FLOATING BALL			FLOATING BALL			3WAY FLOATING BALL			3WAY FLOATING BALL		
Actuators Valves																	
FIG	B-10UTDZ					B-10UTDZM			B-10SCTDZ			B-10UTB2L			B-10UTB4LA		
PRESSURE	10K					10K			10K			10K			10K		
END CONNECTION	JIS B2220					JIS B2220			JIS B2220			JIS B2220			JIS B2220		
DIMENSIONS	inch	mm	L	H	D	L	H	D	L	H	D	L	H	D	L	H	D
	1/2	15	108	202	—	108	202	—	108	202	—	—	—	—	120	296	—
	3/4	20	117	205	—	117	205	—	117	205	—	—	—	—	140	299	—
	1	25	127	299	—	127	299	—	127	299	—	165	207	—	160	303	—
	1 1/4	32	140	303	—	140	303	—	—	—	—	—	—	—	—	—	—
	1 1/2	40	165	358	—	165	358	—	165	358	—	210	318	—	180	380	—
	2	50	178	367	—	178	367	—	178	367	—	220	367	—	200	454	—
	2 1/2	65	190	408	—	190	408	—	190	408	—	250	392	—	240	473	—
	3	80	203	470	—	203	470	—	203	470	—	260	464	—	260	578	—
	4	100	229	498	—	229	498	—	229	498	—	330	491	—	330	600	—
	5	125	356	599	—	356	599	—	356	599	—	—	—	—	—	—	—
BODY	SCS13A					SCS14A			SCPH2 (WCB)			SCS13A			SCS13A		
BONNET	SCS13A					SCS14A			SCPH2			SCS13A			SCS13A		
STEM	SUS304					SUS316			SUS304			SUS304			SUS304		
DISC	SUS304 / SCS13A					SUS316 / SCS14A			SUS304 / SCS13A			SUS304 / SCS13A			SUS304 / SCS13A		
SEAT	HYPATITE PTFE					HYPATITE PTFE			HYPATITE PTFE			HYPATITE PTFE			HYPATITE PTFE		
	Full Port					Full Port			Full Port			Full Port			Full Port		

TYPE	FLOATING BALL					FLOATING BALL			FLOATING BALL			FLOATING BALL			FLOATING BALL		
Actuators Valves																	
FIG	B-10UTBLN					B-150SCTDZ			B-150UTDZ			B-150UTDZM			B-20SCTDZ		
PRESSURE	10K					Class 150			Class 150			Class 150			20K		
END CONNECTION	JIS B2220					ASME B16.5			ASME B16.18			ASME B16.18			JIS B2220		
DIMENSIONS	inch	mm	L	H	D	L	H	D	L	H	D	L	H	D	L	H	D
	1/2	15	140	215	—	108	202	—	108	202	—	108	202	—	140	202	—
	3/4	20	152	217	—	117	205	—	117	205	—	117	205	—	152	205	—
	1	25	165	227	—	127	299	—	127	299	—	127	299	—	165	299	—
	1 1/4	32	—	—	—	—	—	—	140	303	—	140	303	—	—	—	—
	1 1/2	40	191	322	—	165	358	—	165	358	—	165	358	—	190	358	—
	2	50	216	368	—	178	367	—	178	367	—	178	367	—	216	367	—
	2 1/2	65	240	392	—	190	408	—	190	408	—	190	408	—	241	408	—
	3	80	250	467	—	203	470	—	203	470	—	203	470	—	283	470	—
	4	100	280	493	—	229	498	—	229	498	—	229	498	—	305	498	—
	5	125	—	—	—	356	599	—	356	599	—	356	599	—	381	599	—
BODY	SCS13A					A216 Gr.WCB			A351 Gr.CF8			A351 Gr.CF8M			SCPH2 (WCB)		
BONNET	SCS13A					A216 Gr.WCB			A351 Gr.CF8			A351 Gr.CF8M			SCPH2		
STEM	SUS304					A276 TYPE304			A276 TYPE304			A276 TYPE316			SUS304		
DISC	SUS304 / SCS13A					A276 TYPE304 / A351 Gr.CF8			A276 TYPE304 / A351 Gr.CF8			A276 TYPE316 / A351 Gr.CF8M			SUS304 / SCS13A		
SEAT	HYPATITE PTFE					HYPATITE PTFE			HYPATITE PTFE			HYPATITE PTFE			HYPATITE PTFE		
	Full Port					Full Port			Full Port			Full Port			Full Port		

Bronze & Brass  
 Cast Iron  
 Ductile Iron  
 Stainless Steel  
 Carbon Steel  
 Battery Valve  
 Ball Valve  
 Ball Valve Seat  
 Actuated Valve



TYPE		FLOATING BALL					FLOATING BALL			FLOATING BALL			FLOATING BALL			FLOATING BALL			
<b>Actuators Valves</b>																			
FIG		B-20UTDZ					B-20UTDZM			B-300SCTDZ			B-300UTDZ			B-300UTDZM			
PRESSURE		20K					20K			Class 300			Class 300			Class 300			
END CONNECTION		JIS B2220					JIS B2220			ASME B16.5			ASME B16.18			ASME B16.18			
DIMENSIONS	inch	mm	L	H	D	L	H	D	L	H	D	L	H	D	L	H	D		
1/2	15	140	202	--	140	202	--	140	202	--	140	202	--	140	202	--	140	202	--
3/4	20	152	205	--	152	205	--	152	205	--	152	205	--	152	205	--	152	205	--
1	25	165	299	--	165	299	--	165	299	--	165	299	--	165	299	--	165	299	--
1 1/4	32	178	303	--	178	303	--	--	--	--	--	--	--	--	--	--	--	--	--
1 1/2	40	190	358	--	190	358	--	190	358	--	190	358	--	190	358	--	190	358	--
2	50	216	367	--	216	367	--	216	367	--	216	367	--	216	367	--	216	367	--
2 1/2	65	241	408	--	241	408	--	241	408	--	241	408	--	241	408	--	241	408	--
3	80	283	470	--	283	470	--	283	470	--	283	470	--	283	470	--	283	470	--
4	100	305	498	--	305	498	--	305	498	--	305	498	--	305	498	--	305	498	--
5	125	381	599	--	381	599	--	--	--	--	--	--	--	--	--	--	--	--	--
6	150	403	632	--	403	632	--	403	632	--	403	632	--	403	632	--	403	632	--
8	200	502	740	--	502	740	--	502	740	--	502	740	--	502	740	--	502	740	--
BODY		SCS13A					SCS14A			A216 Gr.WCB			A351 Gr.CF8			A351 Gr.CF8M			
BONNET		SCS13A					SCS14A			A216 Gr.WCB			A351 Gr.CF8			A351 Gr.CF8M			
STEM		SUS304					SUS316			A276 TYPE304			A276 TYPE304			A276 TYPE316			
DISC		SUS304 / SCS13A					SUS316 / SCS14A			A276 TYPE304 / A351 Gr.CF8			A276 TYPE304 / A351 Gr.CF8			A276 TYPE316 / A351 Gr.CF8M			
SEAT		HYPATITE PTFE					HYPATITE PTFE			HYPATITE PTFE			HYPATITE PTFE			HYPATITE PTFE			
		Full Port						Full Port						Full Port					

TYPE		BUTTERFLY					BUTTERFLY			FLOATING BALL			FLOATING BALL			3WAY FLOATING BALL			
<b>Actuators Valves</b>																			
FIG		B-10DJ					B-10DJE			BS-10FCT			BS-10FCTB			BS-10FCTB2L			
PRESSURE		10K					10K			10K			10K			10K			
END CONNECTION		Wafer Type (JIS 5K,10K)					Wafer Type (JIS 5K,10K)			BS21 (JIS B0203)			JIS B2239			JIS B2239			
DIMENSIONS	inch	mm	L	H	D	L	H	D	L	H	D	L	H	D	L	H	D		
3/8	10	--	--	--	--	--	--	--	72	202	--	--	--	--	--	--	--		
1/2	15	--	--	--	--	--	--	--	80	212	--	110	212	--	--	--	--		
3/4	20	--	--	--	--	--	--	--	85	215	--	120	215	--	--	--	--		
1	25	--	--	--	--	--	--	--	95	222	--	130	222	--	--	--	--		
1 1/4	32	--	--	--	--	--	--	--	120	298	--	140	298	--	--	--	--		
1 1/2	40	--	--	--	--	--	--	--	120	318	--	165	318	--	210	318	--		
2	50	43	374	--	43	374	--	140	365	--	180	365	--	220	367	--			
2 1/2	65	46	382	--	46	382	--	--	--	--	190	390	--	250	392	--			
3	80	46	420	--	46	435	--	182	464	--	200	464	--	260	464	--			
4	100	52	445	--	52	445	--	--	--	--	230	487	--	330	491	--			
5	125	56	473	--	56	473	--	--	--	--	300	600	--	--	--	--			
6	150	56	485	--	56	545	--	--	--	--	340	625	--	--	--	--			
8	200	60	570	--	60	570	--	--	--	--	450	712	--	--	--	--			
10	250	68	709	--	68	709	--	--	--	--	533	772	--	--	--	--			
12	300	78	734	--	78	734	--	--	--	--	--	--	--	--	--	--	--		
BODY		FCD450-10					FCD450-10			FC200			FC200			FC200			
BONNET		-					-			FC200			FC200			FC200			
STEM		SUS403 / SUS410					SUS403 / SUS410			SUS403			SUS403			SUS403			
DISC		FCD450-10+ENP					FCD450-10+ENP			SUS304 / SCS13A			SUS304 / SCS13A			SCS13A			
SEAT		NBR					EPDM			PTFE			PTFE			PTFE			
		Ductile iron (Ni-plated)						Ductile iron (Ni-plated)			Reduced Port			Full Port			Full Port		





TYPE		FLOATING BALL			FLOATING BALL			FLOATING BALL			FLOATING BALL			FLOATING BALL			
Actuators Valves																	
FIG		BS-10STLBF			BS-10UT			BS-10UTDZ			BS-10UTDZM			BS-10SCTDZ			
PRESSURE		10K			10K			10K			10K			10K			
END CONNECTION		JIS B2239			BS21 (JIS B0203)			JIS B2220			JIS B2220			JIS B2220			
DIMENSIONS	inch	mm	L	H	D	L	H	D	L	H	D	L	H	D	L	H	D
	3/8	10	-	-	-	62	202	-	-	-	-	-	-	-	-	-	-
	1/2	15	108	216	-	65	212	-	108	202	-	108	202	-	108	202	-
	3/4	20	117	219	-	80	215	-	117	205	-	117	205	-	117	205	-
	1	25	127	227	-	90	222	-	127	299	-	127	299	-	127	299	-
	1 1/4	32	140	302	-	110	298	-	140	303	-	140	303	-	-	-	-
	1 1/2	40	165	318	-	120	318	-	165	358	-	165	358	-	165	358	-
	2	50	178	365	-	140	365	-	178	367	-	178	367	-	178	367	-
	2 1/2	65	190	390	-	160	390	-	190	408	-	190	408	-	190	408	-
	3	80	203	464	-	182	464	-	203	470	-	203	470	-	203	470	-
	4	100	229	487	-	-	-	-	229	498	-	229	498	-	229	498	-
	5	125	356	600	-	-	-	-	356	599	-	356	599	-	356	599	-
	6	150	394	625	-	-	-	-	394	632	-	394	632	-	394	632	-
	8	200	457	712	-	-	-	-	457	740	-	457	740	-	457	740	-
	10	250	-	-	-	-	-	-	533	792	-	533	792	-	533	792	-
BODY		Ductile Iron			SCS13A			SCS13A			SCS14A			SCPH2 (WCB)			
BONNET		Ductile Iron			SCS13A			SCS13A			SCS14A			SCPH2			
STEM		SUS403			SUS304			SUS304			SUS316			SUS304			
DISC		SCS13A / SUS304			SUS304 / SCS13A			SUS304 / SCS13A			SUS316 / SCS14A			SUS304 / SCS13A			
SEAT		PTFE			PTFE			HYPATITE PTFE			HYPATITE PTFE			HYPATITE PTFE			
		Full Port			Full Port			Full Port			Full Port			Full Port			

TYPE		3WAY FLOATING BALL			3WAY FLOATING BALL			FLOATING BALL			LAMBDA PORT			FLOATING BALL			
Actuators Valves																	
FIG		BS-10UTB2L			BS-10UTB4LA			BS-10UTBLN			BS-10UVC			BS-15SCTDZ			
PRESSURE		10K			10K			10K			10K			Class 150			
END CONNECTION		JIS B2220			JIS B2220			JIS B2220			JIS B2220			ASME B16.5			
DIMENSIONS	inch	mm	L	H	D	L	H	D	L	H	D	L	H	D	L	H	D
	1/2	15	-	-	-	120	296	-	140	215	-	-	-	-	108	202	-
	3/4	20	-	-	-	140	299	-	152	217	-	-	-	117	205	-	
	1	25	165	207	-	160	303	-	165	227	-	127	306	-	127	299	-
	1 1/2	40	210	318	-	180	380	-	191	322	-	165	369	-	165	358	-
	2	50	220	367	-	200	454	-	216	368	-	178	375.5	-	178	367	-
	2 1/2	65	250	392	-	240	473	-	240	392	-	190	459.5	-	190	408	-
	3	80	260	464	-	260	578	-	250	467	-	203	466	-	203	470	-
	4	100	330	491	-	330	600	-	280	493	-	229	493	-	229	498	-
	5	125	-	-	-	-	-	-	-	-	-	-	-	-	356	599	-
	6	150	-	-	-	-	-	-	-	-	-	394	638	-	394	632	-
	8	200	-	-	-	-	-	-	-	-	-	457	727	-	457	740	-
	10	250	-	-	-	-	-	-	-	-	-	533	751	-	533	792	-
BODY		SCS13A			SCS13A			SCS13A			SCS13A			A216 Gr.WCB			
BONNET		SCS13A			SCS13A			SCS13A			SCS13A			A216 Gr.WCB			
STEM		SUS304			SUS304			SUS304			SUS316			A276 TYPE304			
DISC		SUS304 / SCS13A			SUS304 / SCS13A			SUS304 / SCS13A			SCS14A			A276 TYPE304 / A351 Gr.CF8			
SEAT		HYPATITE PTFE			HYPATITE PTFE			HYPATITE PTFE			-			HYPATITE PTFE			
		Full Port			Full Port			Full Port			Full Port			Full Port			

Brass & Bronze

Cast Iron

Ductile Iron

Stainless Steel

Carbon Steel

Battery Valve

Ball Valve

Ball Valve Seat

Actuated Valve

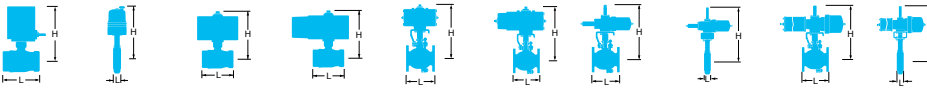

TYPE		FLOATING BALL			FLOATING BALL			FLOATING BALL			FLOATING BALL			FLOATING BALL			
Actuators Valves																	
FIG		BS-150UTDZ			BS-20SCTDZ			BS-20UTDZ			BS-20UTDZM			BS-300SCTDZ			
PRESSURE		Class 150			20K			20K			20K			Class 300			
END CONNECTION		ASME B16.18			JIS B2220			JIS B2220			JIS B2220			ASME B16.5			
DIMENSIONS	inch	mm	L	H	D	L	H	D	L	H	D	L	H	D	L	H	D
	1/2	15	108	202	—	140	202	—	140	202	—	140	202	—	140	202	—
	3/4	20	117	205	—	152	205	—	152	205	—	152	205	—	152	205	—
	1	25	127	299	—	165	299	—	165	299	—	165	299	—	165	299	—
	1 1/4	32	140	303	—	—	—	—	178	303	—	178	303	—	—	—	—
	1 1/2	40	165	358	—	190	358	—	190	358	—	190	358	—	190	358	—
	2	50	178	367	—	216	367	—	216	367	—	216	367	—	216	367	—
	2 1/2	65	190	408	—	241	408	—	241	408	—	241	408	—	241	408	—
	3	80	203	470	—	283	470	—	283	470	—	283	470	—	283	470	—
	4	100	229	498	—	305	498	—	305	498	—	305	498	—	305	498	—
	5	125	356	599	—	381	599	—	381	599	—	381	599	—	—	—	—
	6	150	394	632	—	403	632	—	403	632	—	403	632	—	403	632	—
	8	200	457	740	—	502	740	—	502	740	—	502	740	—	502	740	—
	10	250	533	792	—	—	—	—	—	—	—	—	—	—	—	—	—
BODY		A351 Gr.CF8			SCPH2 (WCB)			SCS13A			SCS14A			A216 Gr.WCB			
BONNET		A351 Gr.CF8			SCPH2			SCS13A			SCS14A			A216 Gr.WCB			
STEM		A276 TYPE304			SUS304			SUS304			SUS316			A276 TYPE304			
DISC		A276 TYPE304 / A351 Gr.CF8			SUS304 / SCS13A			SUS304 / SCS13A			SUS316 / SCS14A			A276 TYPE304 / A351 Gr.CF8			
SEAT		HYPATITE PTFE			HYPATITE PTFE			HYPATITE PTFE			HYPATITE PTFE			HYPATITE PTFE			
		Full Port			Full Port			Full Port			Full Port			Full Port			

TYPE		FLOATING BALL			FLOATING BALL			BUTTERFLY			BUTTERFLY			
Actuators Valves														
FIG		BS-300UTDZ			BS-300UTDZM			BS-10DJ			BS-10DJE			
PRESSURE		Class 300			Class 300			10K			10K			
END CONNECTION		ASME B16.18			ASME B16.18			Wafer Type (JIS 5K,10K)			Wafer Type (JIS 5K,10K)			
DIMENSIONS	inch	mm	L	H	D	L	H	D	L	H	D	L	H	D
	1/2	15	140	202	—	140	202	—	—	—	—	—	—	—
	3/4	20	152	205	—	152	205	—	—	—	—	—	—	—
	1	25	165	299	—	165	299	—	—	—	—	—	—	—
	1 1/4	32	190	358	—	190	358	—	—	—	—	—	—	—
	1 1/2	40	216	367	—	216	367	—	43	374	—	43	374	—
	2	50	241	408	—	241	408	—	46	382	—	46	382	—
	2 1/2	65	283	470	—	283	470	—	46	435	—	46	420	—
	3	80	305	498	—	305	498	—	52	445	—	52	445	—
	4	100	—	—	—	—	—	—	56	473	—	56	473	—
	5	125	403	632	—	403	632	—	56	545	—	56	485	—
	6	150	502	740	—	502	740	—	60	570	—	60	570	—
	8	200	—	—	—	—	—	—	68	709	—	68	709	—
	10	250	—	—	—	—	—	—	78	734	—	78	734	—
BODY		A351 Gr.CF8			A351 Gr.CF8M			FCD450-10			FCD450-10			
BONNET		A351 Gr.CF8			A351 Gr.CF8M			—			—			
STEM		A276 TYPE304			A276 TYPE316			SUS403 / SUS410			SUS403 / SUS410			
DISC		A276 TYPE304 / A351 Gr.CF8			A276 TYPE316 / A351 Gr.CF8M			FCD450-10+ENP			FCD450-10+ENP			
SEAT		HYPATITE PTFE			HYPATITE PTFE			NBR			EPDM			
		Full Port			Full Port			Ductile iron (Ni-plated)			Ductile iron (Ni-plated)			



## CAUTION

Pressure-temperature ratings and other performance data published in this catalog have been developed from our design calculation, in-house testing, field reports provided by our customers and / or published official standards or specifications. They are good only to cover typical applications as a general guideline to users of KITZ products introduced in this catalog.

For any specific application, users are kindly requested to contact KITZ Corporation for technical advice, or to carry out their own study and evaluation for proving suitability of these products to such an application. Failure to follow this request could result in property damage and / or personal injury, for which we shall not be liable.

While this catalog has been compiled with the utmost care, we assume no responsibility for errors, impropriety or inadequacy. Any information provided in this catalog is subject to from-time-to-time change without notice for error rectification, product discontinuation, design modification, new product introduction or any other cause that KITZ Corporation considers necessary. This edition cancels all previous issues.

Read instruction manual carefully before use.

## NOTICE

If any products designated as strategic material in the Foreign Exchange and Foreign Trade Law, Cabinet Order Concerning Control of Export Trade, Cabinet order Concerning Control of Foreign Exchange and other related laws and ordinances ("Foreign Exchange Laws") are exported to any foreign country or countries, an export license issued by the Japanese Government will be required under the Foreign Exchange Laws.

Further, there may be cases where an export license issued by the government of the United States or other country will be required under the applicable export-related laws and ordinances in such relevant countries.

The contract shall become effective subject to that a relevant export license is obtained from the Japanese Government.

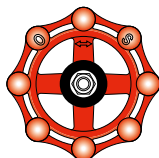

*A chrysanthemum-handle is a symbol of KITZ,  
the brand of valve reliability*

ISO 9001 certified since 1989

**KITZ**  
KITZ CORPORATION

1-10-1, Nakase, Mihama-ku, Chiba 261-8577, Japan  
International Sales Dept.

Phone : 81-43-299-1730, 1732 and 1733

Fax : 81-43-299-0121

— Distributed by —