

# 10K CAST STAINLESS STEEL BALL VALVES, WITH KITZ-ELECTRIC ACTUATOR KELMO

KITZ Fig: EA200-UTE

Sizes: 1/4-2inch(8-50mm)

REDUCED BORE, SCREWED ENDS.

Standards

. End to End: KITZ STANDARD

. End Connection: JIS B0203 (5)

. Wall Thickness: KITZ STANDARD

Test Standard

. KITZ STANDARD

Conform to

RoHS 8-50 mm (1/4-2 inch)

approved

Dimensions

SIZE (inch/mm)	L	L1	H	D1	Kg
1/4 8	44.0	21.0	102.0	0.0	0.00
3/8 10	44.0	21.0	102.0	0.0	0.00
1/2 15	56.5	27.5	102.0	0.0	0.00
3/4 20	59.0	30.0	105.0	0.0	0.00
1 25	71.0	36.0	108.0	0.0	0.00
1 1/4 32	78.0	40.0	132.5	0.0	0.00
1 1/2 40	83.0	42.5	135.5	0.0	0.00
2 50	100.0	51.0	141.5	0.0	0.00

Material List

NAME OF PART	MATERIAL	SPECIFICATION
BODY	STAINLESS STEEL	A351 Gr. CF8M/SCS14A
STEM	STAINLESS STEEL	316SS(2)
BALL	STAINLESS STEEL	316SS

Specifications

10K CAST STAINLESS STEEL BALL VALVES, WITH KITZ-ELECTRIC ACTUATOR KELMO, REDUCED BORE, SCREWED ENDS.

End to End : KITZ STANDARD, End Connection : JIS B0203 (5), Wall Thickness : KITZ STANDARD, Test Standard : KITZ STANDARD, Sizes : 1/4-2inch(8-50mm), Conform to : RoHS 8-50 mm (1/4-2 inch), BODY MATERIAL : STAINLESS STEEL, STEM MATERIAL : STAINLESS STEEL, BALL MATERIAL : STAINLESS STEEL, KITZ Fig : EA200-UTE

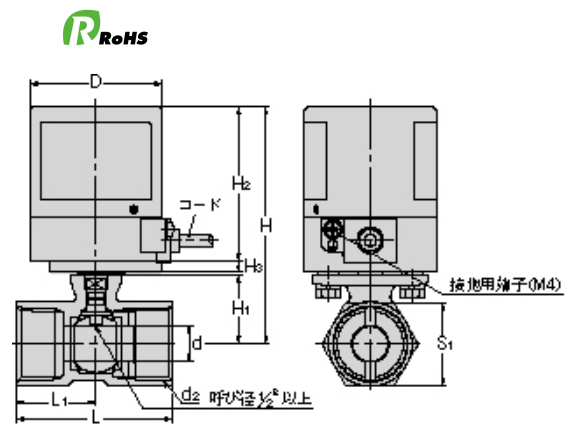

For more details, please refer to the drawing.

Pressure-temperature ratings and other performance data published in this catalog have been developed from our design calculation, in-house testing, field reports provided by our customers and/or published official standards or specifications. They are good only to cover typical applications as a general guideline to users of KITZ products introduced in this catalog. For any specific application, users are kindly requested to contact KITZ Corporation for technical advice, or to carry out their own study and evaluation for proving suitability of these products to such an application. Failure to follow this request could result in property damage and/or personal injury, for which we shall not be liable. Read instruction manual carefully before use.

# KITZ

KITZ CORPORATION Tokyo Shiodome Building, 1-9-1, Higashi-Shimbashi, Minato-ku, Tokyo 105-7305, Japan  
© KITZ Corporation. All Right Reserved.

ISO 9001  
CERTIFIED  
Since 1989