KITZ

Operation Manual

KITZ ED Series Electric Actuators

for KITZ Compact Ball Valves

Thank you for having chosen KITZ products.

For safe and trouble-free use of the product, ensure to carefully read every instruction provided in this manual beforehand. Keep this manual in a convenient place for easy access of all valve operating personnel.

NOTES TO USERS

This manual provides users with the instructions on correct use of KITZ ED Series electric actuators. Ensure to carefully read all the items of this manual before handling, storage, installation, operation and maintenance of the product.

This manual covers the normal use of the product as a general guide to users, but does not necessarily cover all possible conditions or situations that may be caused to users while using the product. If technical assistance beyond the scope of this manual is required, users are recommended to contact KITZ Corporation or the distributors in their locations.

Numerical limits and procedures of operation, maintenance and inspection provided in this manual are specified in consideration of safe and trouble-free operation of the product. It is forbidden to use the product in any condition that may exceed such numerical limits or conflict with such procedures.

Drawings, tables, photographs and illustrations of the product in this manual provide users with only the basic information. Ask KITZ Corporation or the distributors for detailed assembly drawings of the products, if needed.

Any information provided in this manual is subject to from-time-to-time change without notice for error rectification, product discontinuation, design modification, or any other causes that KITZ Corporation considers necessary.

SAFETY CAUTIONS

This manual calls users' careful attention to the dangers and hazards that may be caused to personnel or properties during handling, storage, installation, operation or maintenance of the product. Such dangers and hazards are specifically highlighted in the operation manual with either one of the following marks.



WARNING

A warning indicates a potentially hazardous condition that may result in serious injury or death of personnel, if such a warning is ignored.



CAUTION

A caution indicates a potentially hazardous condition that may result in minor injury to personnel or damage to properties, if such a caution is ignored.



Indicates to call attention of an action.



Indicates prohibition of dismantling



Indicates prohibition of an action.



Indicates attention to explosion



Indicates mandatory implementation of an action.



Indicates prohibition of touch



Indicates attention to electric shock

If any item of this manual is not strictly followed by users, KITZ Corporation shall have no responsibility for any resulting accident or failure of the product.

Contents

	Page
1. Design and Functions	1
1-1. Technical Features	1
1-2. Product Coding	1
1-3. Appearance Diagrams and Dimensions	2
1-4. Actuator-valve Assembly	4
1-5. Design Specifications	6
1-6. Electric Wiring Diagrams	7
1-7. Functions of Type ED(B) Actuators	8
2. Handling and Storage	9
3. Piping Installation	10
3-1. Recommended Service Environments	10
3-2. Cautions for Piping Installation	11
3-3. Cautions for Electric Wiring	14
4. Operation	17
4-1. Manual Operation	17
4-2. Electric Operation	20
4-3. Operational Precautions	21
4-4. Maintenance and Inspection	23
4-5. Dismantling and Reinstallation	23
4-6. Trouble Shooting	25
5. Product Warranty	27

1. Design and Functions

1-1. Technical Features

Actuators are designed for DC12V/24V. Devices provided with DC control circuits or battery power supplies can be used for driving actuators.

Actuators are ready for assembly with KITZ compact ball valves made of copper alloy and austenitic stainless steel for high versatility of applications.

KITZ compact ball valves are designed with smaller pressure loss than solenoid valves in general.

Precision machined KITZ balls and plastic ball seats guarantee high sealing performance and smooth valve operation.

1-2. Product Coding

Application	Shut-off and release of water, oil and air
Product coding	<div style="display: flex; align-items: center; justify-content: center;"> <div style="text-align: center; margin-right: 20px;"> <p>ED (B) 12/24 -</p> </div> <div> <p>Valve size (*)</p> <p>Valve type (*)</p> <p>12: Power supply: DC12V 24: Power supply: DC24V</p> <p>No code: with cables B: with an optional terminal box</p> <p>Actuator type: KITZ ED Series actuator type symbol</p> </div> </div> <p>* Refer to KITZ Catalog E-301 for details of valve types and sizes.</p>

1-3. Appearance Diagrams and Dimensions

Fig.1 Type ED 12/24 Size 1

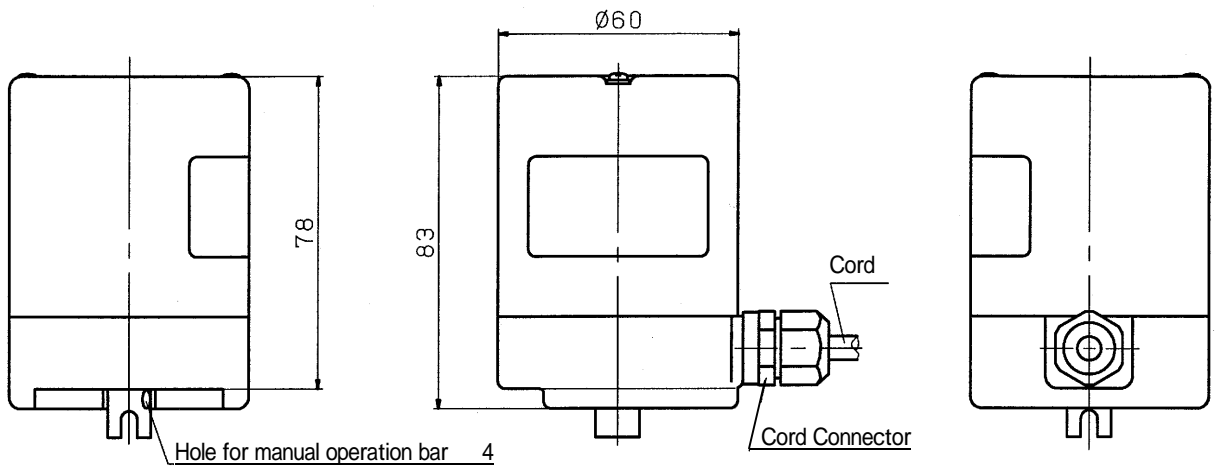

Fig.2 Type ED 12/24 Size 2

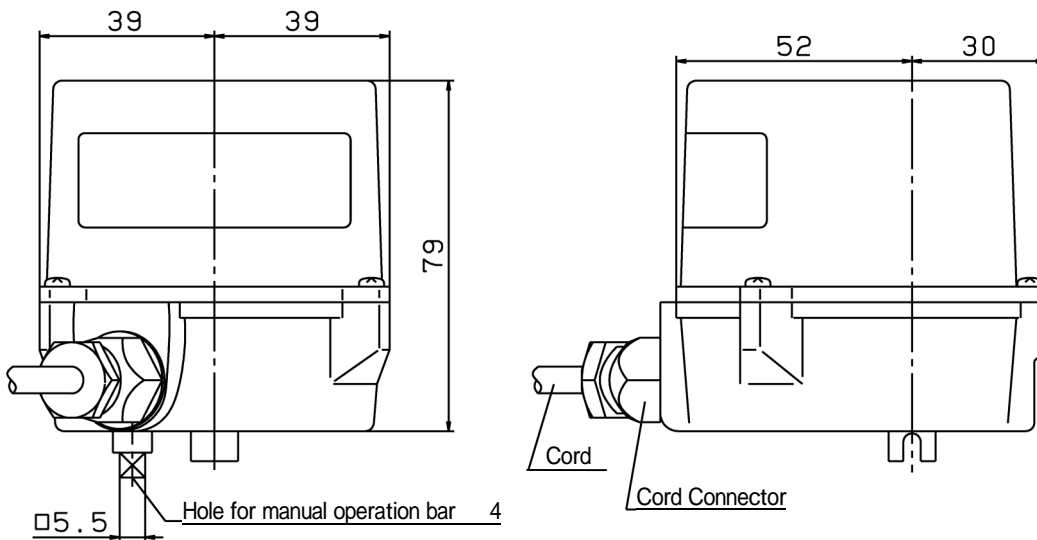

Fig.3 Type EDB 12/24 Size 1

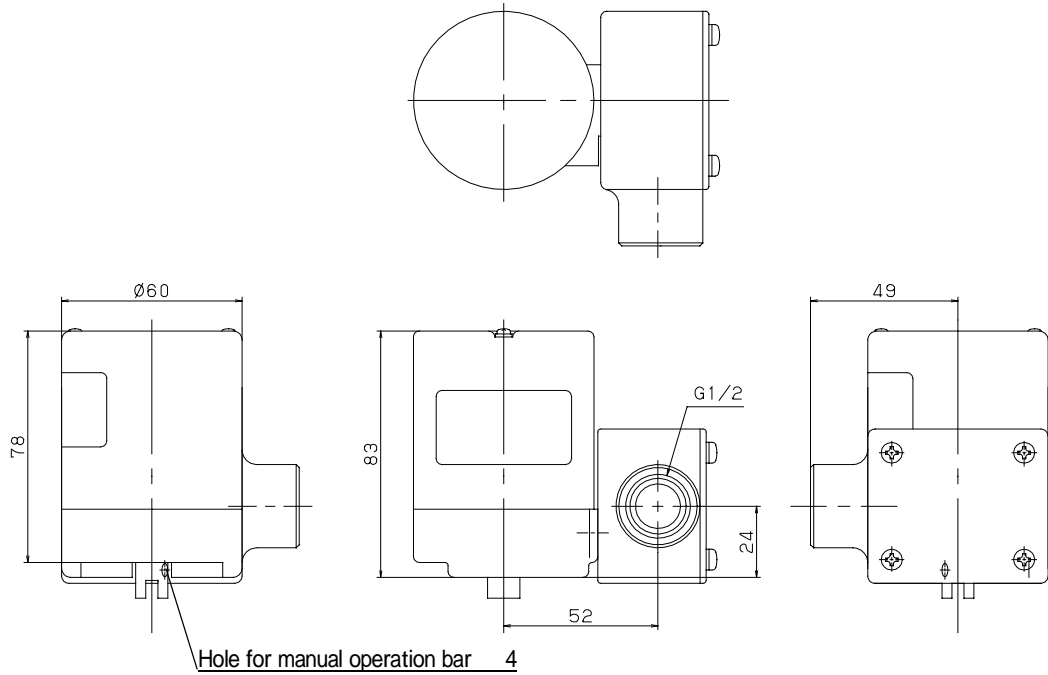
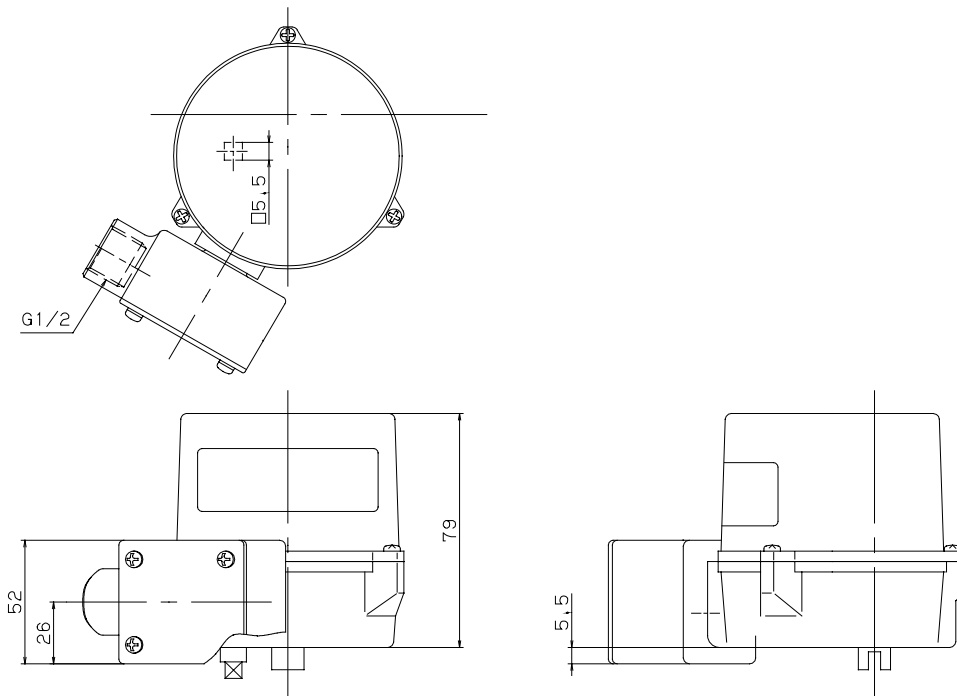
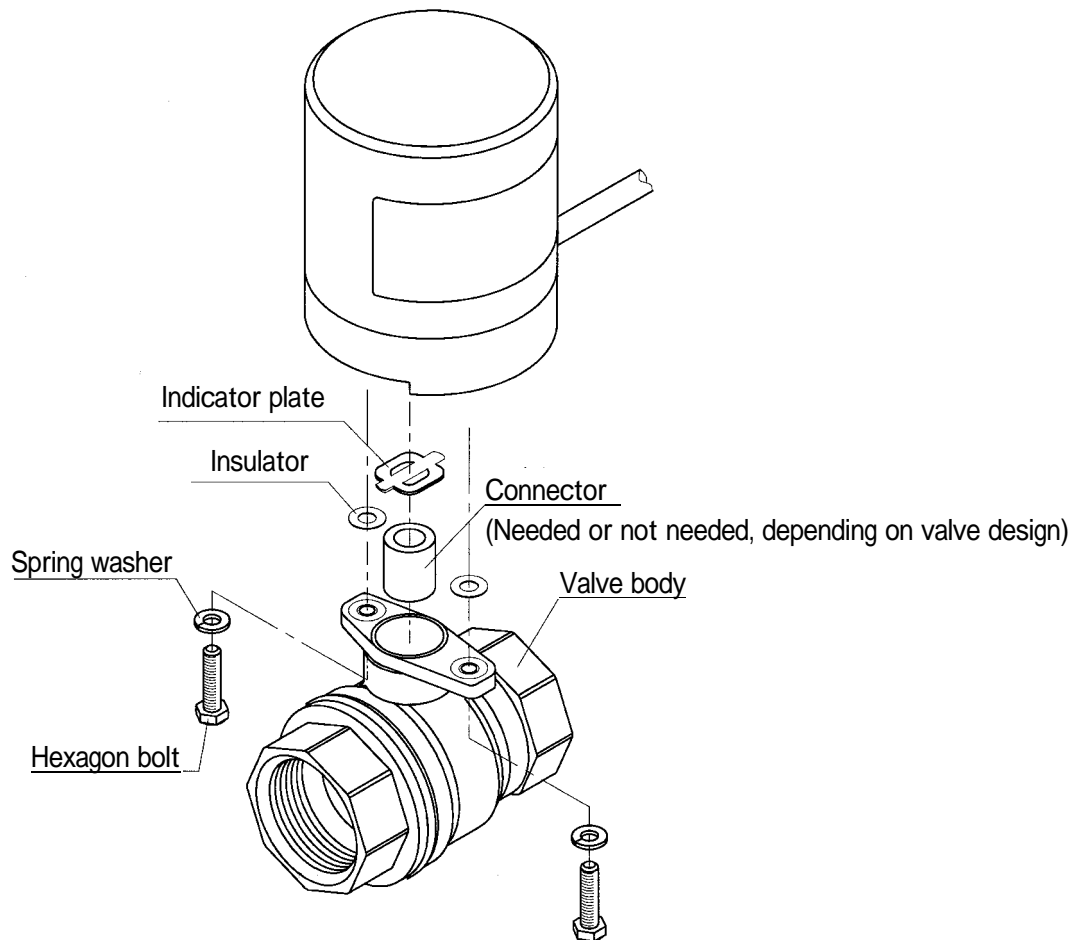







Fig.4 Type EDB 12/24 Size 2







1-4. Actuator-valve Assembly

Fig.5 Actuator-valve assembly



⚠ WARNING	
	<ul style="list-style-type: none"> Actuators are not designed for explosion-proof. Do not install them in any explosive environment to prevent accidental mishaps. Do not install them in any corrosive environment which may affect service life.
	<ul style="list-style-type: none"> Do not carry out wiring works on actuators being energized, and do not remove covers of their housings during wiring, to eliminate the danger of an electric shock.
	<ul style="list-style-type: none"> Do not disassemble energized actuators from valves. It will damage valves or actuators and cause problems.
	<ul style="list-style-type: none"> Do not put your fingers or foreign objects such as tools into ports of valves being fully opened or closed. It may cause injuries or equipment damages.
	<ul style="list-style-type: none"> Before dismantling actuated valves from piping, ensure to equalize the piping pressure with the ambient pressure and thoroughly release line fluid from the piping. Otherwise, residual pressure and line fluid will dangerously extrude from valve bores.

 CAUTION	
	<ul style="list-style-type: none">• Factory-assembled actuated valves are adequately adjusted for satisfactory function and performance. Do not disassemble them for any reason, unless approved in advance by KITZ Corporation, as it may cause valve malfunction, valve seat leakage and other technical problems.
	<ul style="list-style-type: none">• This manual covers the procedures to properly handle KITZ compact ball valves driven by KITZ ED Series actuators. Refer to KITZ Catalog K-301 for details of ball valve designs and specifications.• Ensure to follow all instructions given in this manual on piping installation, electric wiring, maintenance and inspection of actuated valves, to eliminate concerns of accidental mishaps and product failures.
	<ul style="list-style-type: none">• Mounting actuated metal valves on plastic piping may cause an excessive load during manual operation, and damage the piping. Care must be taken to eliminate such a concern.

1-5. Design Specifications

Two sizes (Size 1 and Size 2) are available for KITZ ED Series electric actuators to efficiently drive different sizes of KITZ compact ball valves, as briefly introduced in KITZ Catalog E-310 .

Table 1 Specifications of Type ED(B) 12/24 Size 1 and 2

Type-size Specifications	ED(B)12-1	ED(B)24-1	ED(B)12-2	ED(B)24-2
Power supply	DC12V	DC24V	DC12V	DC24V
Rated current	360mA	140mA	520mA	260mA
Starting current	0.4A	0.5A	1.9A	0.95A
Max. power consumption	5W	4W	9W	10W
Approx. 90 ° operation time	About 5 seconds			
Max. output torque	1.4N·m		7.3N·m	
Duty factor	5 minutes			
Insulation class	Class E			
Position limit switch	1 each for opening/closing (voltage output)			
Insulation strength	1 min./DC250V		1 min./DC500V	
Insulation resistance	Minimum 10M (DC 250V)			
Service environment	Outdoor (no direct exposure to the sunlight)			
Ambient temperature	-20 ~ +50			
Mounting orientation	Vertical to horizontal (no downwards)			
Power cable / cable connection	vinyl sheathed cable		Non-flammable cord (UL STYLE2464)	
	0.3mm ² x 700mm		0.5mm ² x 700mm	
	Connection with M3 terminal (for Type EDB)			
Lubrication	Grease			
Overload protection	Impedance protection		Over current protective element	
Painting color	Black housing with light blue cover			

Maximum voltage variation: $\pm 10\%$

NOTES

Power cables and cable connections for Type EDB and Type ED are different from one another. Only type ED(B)12/24-2 can use for in-vehicle products. However when the vehicle is washed, jet water never flash to the actuator directly. Type ED(B)12/24-2 actuators can be used as in-vehicle devices. On washing cars, however, take care never to directly apply jet water pressure to actuators.

1-6. Electric Wiring Diagrams

Fig.6 Wiring of Type ED(B) 12/24 Size 1

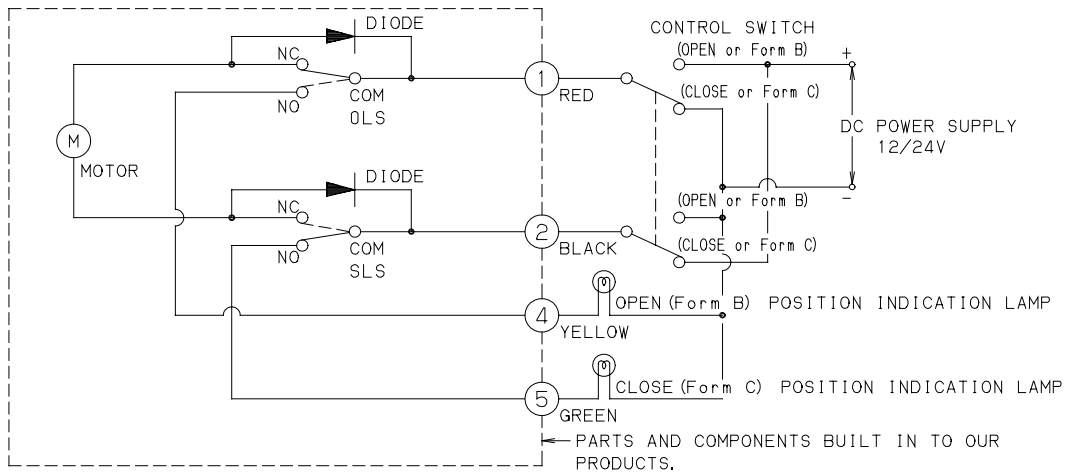

Fig.7 Wiring of Type ED(B) 12/24 Size 2

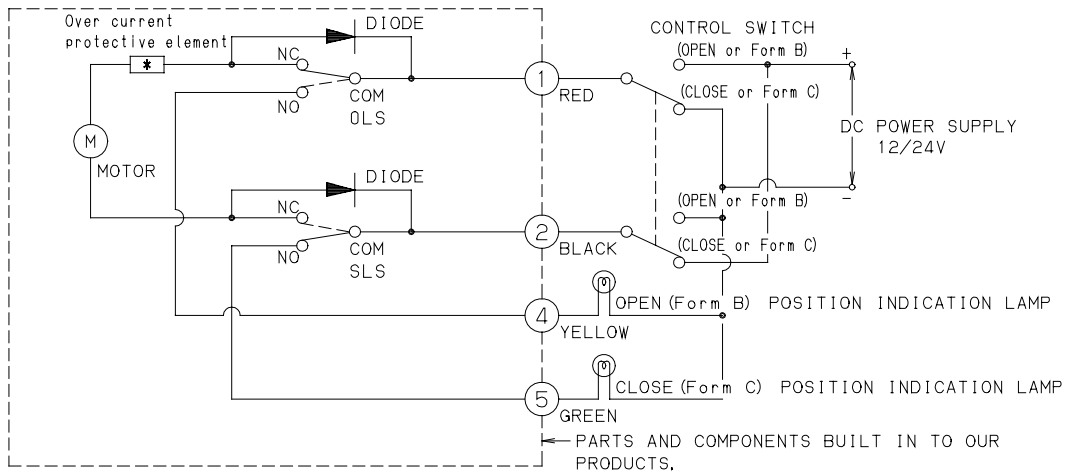

Fig.8 Terminal box; Option with product code (B)

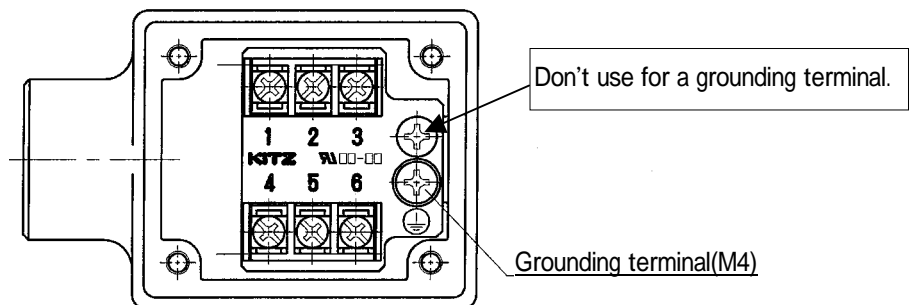

Fig.6 to Fig.7 all show the electric wiring diagrams at the fully closed position of a valve. Circled numbers , , and indicate the identification numbers of terminals of an optional terminal box (Fig.8). Terminal and are left open as a spare terminal.

1-7. Functions of Type ED(B) Actuators

1-7-1. For 2-way compact ball valves

- (1) Circuit direction (Viewed from the top of an actuator)
 - Contact of Red- (+) to Black- (-) counterclockwise drives a valve to fully open it.
 - Contact of Red- (-) to Black- (+) clockwise drives a valve to fully close it.

- (2) Action of limit switches
 - OLS turns the source power off when a valve is fully open, while Red- and -yellow (type ED-1) or white (type ED-2) are in contact.
 - SLS turns the source power off when a valve is fully closed, while Black- and Green- are in contact.

1-7-2. For 3-way compact ball valves

- (1) Circuit direction (Viewed from the top of an actuator)
 - Contact of Red- (+) to Black- (-) counterclockwise drives a valve to stop at Form B flow path.
 - Contact of Red- (-) to Black- (+) clockwise drives a valve to stop at Form C flow path.

- (2) Action of limit switches
 - BLS turns the source power off when a valve stops at Form B flow path, while Red- and -yellow (type ED-1) or white (type ED-2) are in contact
 - CLS turns the source power off when a valve stops at Form C flow path, while Black- and Green- are in contact.

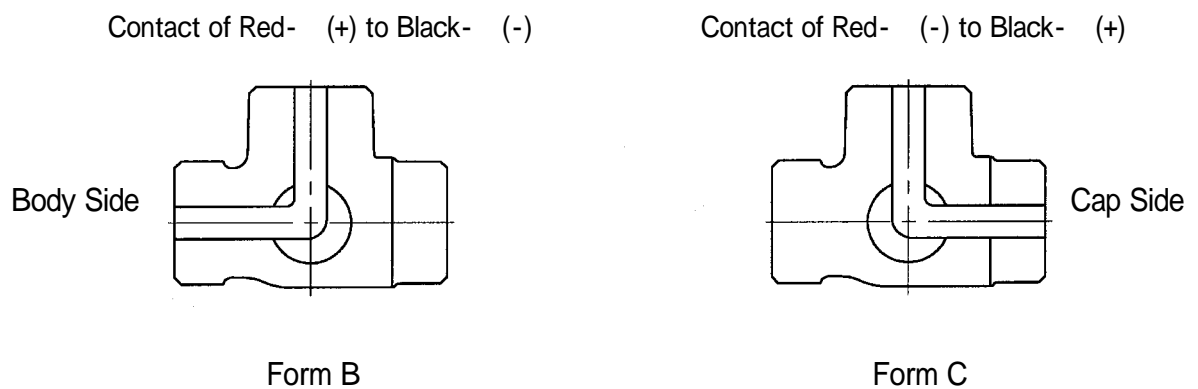







Fig.9 Flow paths of KITZ horizontal 3-way compact ball valves
(Viewed from the top of an actuator)



2. Handling and Storage

 CAUTION	
	<ul style="list-style-type: none"> ● Handle actuated valves by holding valve bodies. Holding instrumentation cables will cause electric wiring failures and other troubles (Fig.10). ● Do not fall the product on the ground. Protect the product from excessive impact shock or vibration to eliminate concerns of malfunction (Fig.11). ● Overloading the product must be prevented. Do not place any heavy object on the product. Do not step on the product. ● Do not store the product in the following conditions: <ul style="list-style-type: none"> · Direct exposure to the sunlight · Exposure to dusts, corrosive gas, water drops and salty wind. · Exposure to steam or radiant heat caused by steam piping · Indoor in exposure to weather, and outdoor · 80% or higher relative humidity
	<div style="display: flex; justify-content: space-around; align-items: center;"> <div style="text-align: center;">  <p>Fig.10</p> </div> <div style="text-align: center;">  <p>Fig.11</p> </div> </div>
	<ul style="list-style-type: none"> ● Do not disassemble the product to avoid malfunction or damage of the product.
	<ul style="list-style-type: none"> ● The product is carefully packed to protect actuators and valves from intrusion of dusts and other foreign objects. Do not unpack the product until you are ready for installation on piping. ● Keep a valve fully open during storage. Leaving it partly open for a long period of time will cause seat deformation, resulting in internal fluid leakage. Leaving it fully closed for long will make dusts and other foreign objects stuck to ball surface and damage a ball and ball seats on starting valve operation.

3. Piping Installation

3-1. Recommended Service Environments

 WARNING	
	<ul style="list-style-type: none"> The product is not designed for explosion-proof. Do not install it in any explosive environment to prevent accidental mishaps. Also do not install it in any corrosive environment which will affect the service life.

 CAUTION	
	<ul style="list-style-type: none"> Do not install the product where rainwater may gather high enough to submerge the product installed on piping. Do not install the product where the vibration generated by nearby facilities might affect the function of the product. Otherwise, take appropriate protective measures to insulate the vibration
	<ul style="list-style-type: none"> Do not install the product where it is directly exposed to the sunlight. Otherwise, take appropriate protective measures such as installation of a cover or a shelter. Raising the temperature of the product may cause malfunction and affect service life of the product. Protect the product appropriately in environments where salty water, snow or freeze may affect functions of the product. Keep a sufficient room around the installed product to ease dismantling, disassembly, manual operation, maintenance and re-installation of the product. Where the product is exposed to radiant heat, take appropriate protective measures such as installation of a cover or a shelter. Where access of passersby to the product is concerned about, such as where the piping directly faces to a road, take appropriate protective measures like installation of a fence or an enclosure.

3-2. Cautions for Piping Installation

⚠ CAUTION

- **Do not** apply too much sealing materials for piping. An excessive application may cause intrusion of sealing materials into the valve interior and cause malfunction or internal leakage of line fluid. The first one or two threads of piping ends are better to be left free from sealing materials.

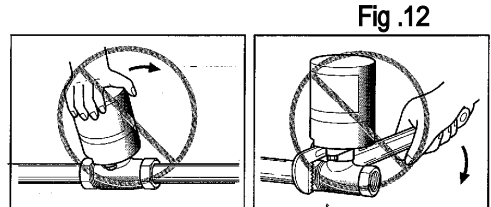

- **Do not** apply an excessive load by hand to adjust mounting orientation of an actuated valve, or **do not** tighten a valve with a wrench, to eliminate a risk of damaging the valve (Fig.12).

- **Do not** excessively thread a valve into a pipe. It will damage or distort the valve interior and cause malfunction of the valve or external fluid leakage (Fig.13).

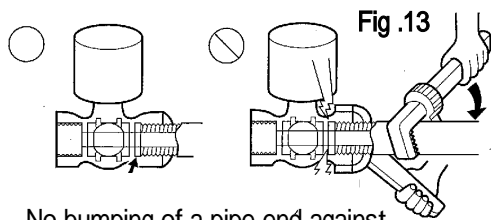

Thread the valve with a tightening torque recommended in Table 2.

- **Do not** hold a valve with a vice to eliminate a concern of deformation or damage of the valve, which may cause valve malfunction or external fluid leakage (Fig.14).

No bumping of a pipe end against the valve interior:
No scratching



- **Do not** apply an external force to a valve counterclockwise during mounting on piping. It may loosen the body-cap joint of the valve and cause external fluid leakage.

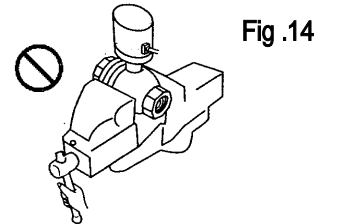

- **Do not** mount an actuated valve facing downward to the ground to prevent possible water intrusion into the actuator interior. Mount it on piping horizontally, vertically or at any intermediate angle, depending on piping or operating convenience (Fig.15).

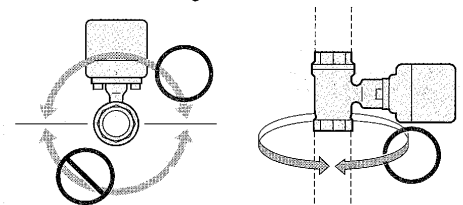

- **Do not** overload an actuator, or step on it during mounting of an actuated valve on piping, to eliminate concerns of fluid leakage and product malfunction (Fig.16).

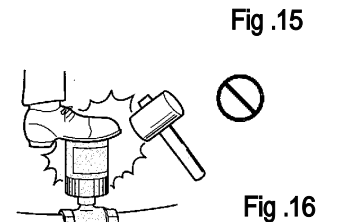

- **Do not** open or close a valve for any reason, while being flushed after piping installation. It will damage valve seats with foreign residues left inside the valve bore, and result in internal fluid leakage.

⚠ CAUTION



- Mount an actuated valve with a wrench firmly held around the valve end, which is jointed with a pipe. Holding the wrench around another valve end, which is open to the atmosphere, may cause a too excessive load to the valve body (**Fig.17**).

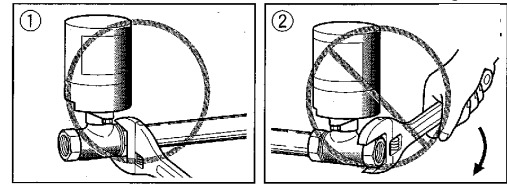

Fig.17

- **Do not** apply any excessive bending moment to an actuated valve, to avoid valve body deformation and valve functional failure.
- Provide an appropriate support to an actuated valve, if the weight of the valve and operation cycles may cause an excessive load to the piping. Where metal valves are mounted on plastic piping, care must be particularly taken to securely support the both ends of the valve.
- If sands, metallic particles and other foreign objects are contained in the line fluid, ensure to mount a filtering device such as a strainer on the upstream side piping. These foreign objects may get stuck around valve seats and affect valve function or cause internal fluid leakage

Prior to piping installation, check that the design specifications of an actuated valve all satisfy service conditions.

Also remove dusts, scales and other foreign residues from valve end threads and piping internals

Check the kind and the standard of valve threads with a gauge and confirm that the required number of effective threads are provided.

For threading a valve into piping, use a wrench held around the valve end, which is jointed with a pipe.

Thread a valve with a tightening torque recommended in **Table 2**.

Table 2 Thread Tightening Torque

Valve size	1/2	3/4	1	1-1/4	1-1/2	2
Tightening torque N·m	20 ~ 29	39 ~ 49	49 ~ 59	59 ~ 69	69 ~ 78	78 ~ 88

To threaded ends, apply the sealing material which is suitable to the service fluid and temperature.

After piping installation, fully open valves and flush the piping to remove all internal residues.

Use of a flexible tube is recommended for threading 3-way ball valves. **(Fig.18)**.

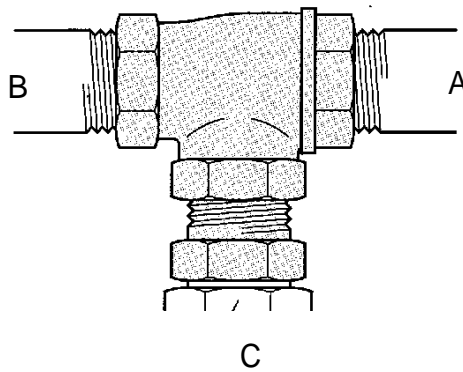



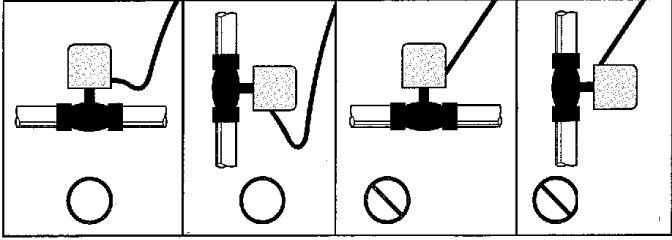





Fig.18

3-3. Cautions for Electric Wiring

 WARNING	
	<ul style="list-style-type: none"> ● Ensure to switch off an actuator before electric wiring, to eliminate the danger of an electric shock. ● After electric wiring, securely tighten a cover onto a terminal board with screws. Leaving the cover left open may cause an electric shock at the moment of energizing an actuator. (For EDB type actuators) ● Do not work for electric wiring in rainwater, to avoid the danger of an electric shock.
	<ul style="list-style-type: none"> ● Do not unnecessarily pull out connecting cables and wires, as they may get disconnected and cause an electric shock. Cabling an actuator to the power source with some slack is recommended (Fig.19). <div style="text-align: center;">  <p>Fig.19</p> </div>

 CAUTION	
	<ul style="list-style-type: none"> ● Do not modify an actuator for any reason, to avoid concerns of functional failures. ● Do not separate an actuator-valve assembly or disassemble an actuator, to avoid damage of the actuator.
	<ul style="list-style-type: none"> ● Do not operate two or more actuated valves with a single opening/closing switch for any reason.
	<ul style="list-style-type: none"> ● An actuator is designed for either DC12V or DC24V. Check that the power source voltage on site matches to the design specification of an actuator. ● Ensure to make correct wiring to eliminate the danger of an earth leakage or a short circuit. Work for electric wiring according to the indication attached to an actuator. Incorrect wiring may damage instrumentation devices. ● If visual opening and closing indicators are not considered necessary, do not connect the terminal -yellow (type ED-1) or white (type ED-2), and terminal -green wires. For protection of an electric shock or a short circuit, ensure to cut the edges of these wires and appropriately isolate them. ● Ensure to thoroughly seal a cable connector, a cable gland and a terminal box conduit port, to protect an actuator and a terminal box from intrusion of water. Insufficient sealing will corrode them and cause malfunction and other troubles. (For EDB type actuators)

⚠ CAUTION

- There is a small gap between an electric cable and inner wires. If waterproofing of cable connections and exposed cable ends is not adequately done, capillary phenomenon may cause water intrusion into the interior of an actuator, resulting in corrosion of parts and components. To prevent malfunction of an actuator, ensure to adequately waterproof all cable connections and exposed cable ends (Fig.20).

Waterproofing for edges of unused electric cables, and for joint of cable wires with relay cables.

Waterproofing clearance between cables and cable sheath.

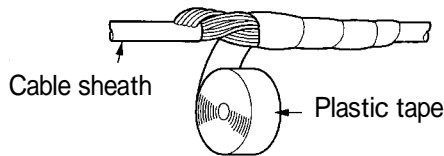
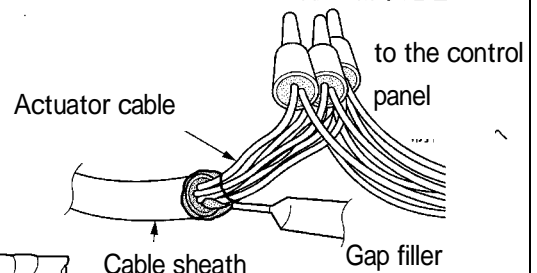
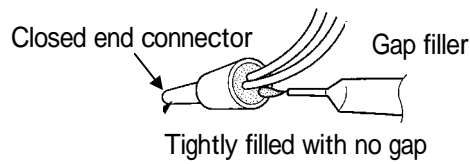

Fig.20

Tightly bundle cables in a cable sheath and firmly cover them cable ends with a plastic tape, after having applied some gap filler.

- Ensure to isolate open ends of unused cables and wires to eliminate concerns of a short circuit and actuator malfunction.
- A rubber gasket is provided on the cover of an optional terminal box. Take care not to cause scratches to the gasket and the gasket contact face of the cover to protect its sealing function.



- Take care not to misplace or lose the screws used for fixing a cover on a terminal board. Ensure to evenly fix all screws. Uneven threading may allow water intrusion into the terminal box and result in a short circuit or internal corrosion.

Note 1. Electric wiring must be worked by the personnel who are officially qualified according to relevant national standards, rules and/or regulations.

Note 2. Refer to the wiring diagram shown on a housing cover of an actuator for correct wiring.

Note 3. Specification for option of M3 terminal box:

M3 terminal box

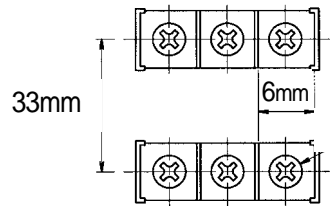

■ Recommended crimping terminals:



- (1) A closed end connector with wire cohesion range of 0.5mm^2 to 1.75mm^2 , AWG22 to AWG20, for a relay crimping terminal sleeve of an actuator with cable:
- (2) A ring terminal R/0.3 to 3 with stranded wire range of 0.3mm^2 to 0.5mm^2 , AWG22 to AWG20, for a crimping terminal of an actuator with an optional terminal box:



Cable conduit port: G1/2

Cable connector: 10.5mm to 14.5mm, which fits the outside diameter of a cable.

4. Operation

4-1. Manual Operation

⚠ WARNING	
	<ul style="list-style-type: none"> ● Do not disassemble an energized actuator from a valve to eliminate concerns of damage of the valve and other troubles.
	<ul style="list-style-type: none"> ● Prior to electric operation, ensure to remove the bar or any other tools used for manual operation. It may jump off at the moment of turning on an actuator and cause an accident.

⚠ CAUTION	
	<ul style="list-style-type: none"> ● Ensure to turn off an actuator for manual operation not to damage the actuator.
	<ul style="list-style-type: none"> ● Manual operation must be done slowly to prevent an actuator from damage or malfunction.
	<ul style="list-style-type: none"> ● Manual operation of a horizontal 3-way ball valve may cause cross flow of line fluids at the moment of manual operation. If cross flow should be avoided by all means, ensure to manually operate a valve, after having fully shut off the upstream pressure.

4-1-1. Manual operation of Type ED(B)12/24 actuator, Size 1

An actuated valve is fully open, when a position indicator marked in red becomes visible below the bottom of the housing. No visibility of the red mark means that the valve is set fully closed (Fig.21). In the case of a horizontal 3-way ball valve, the red mark becomes visible either on the side of Form B or C, depending on the path of the fluid flow (Fig.22).

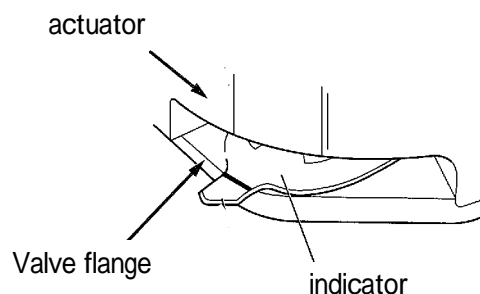

Fig.21 Position indicator for 2-way ball valves

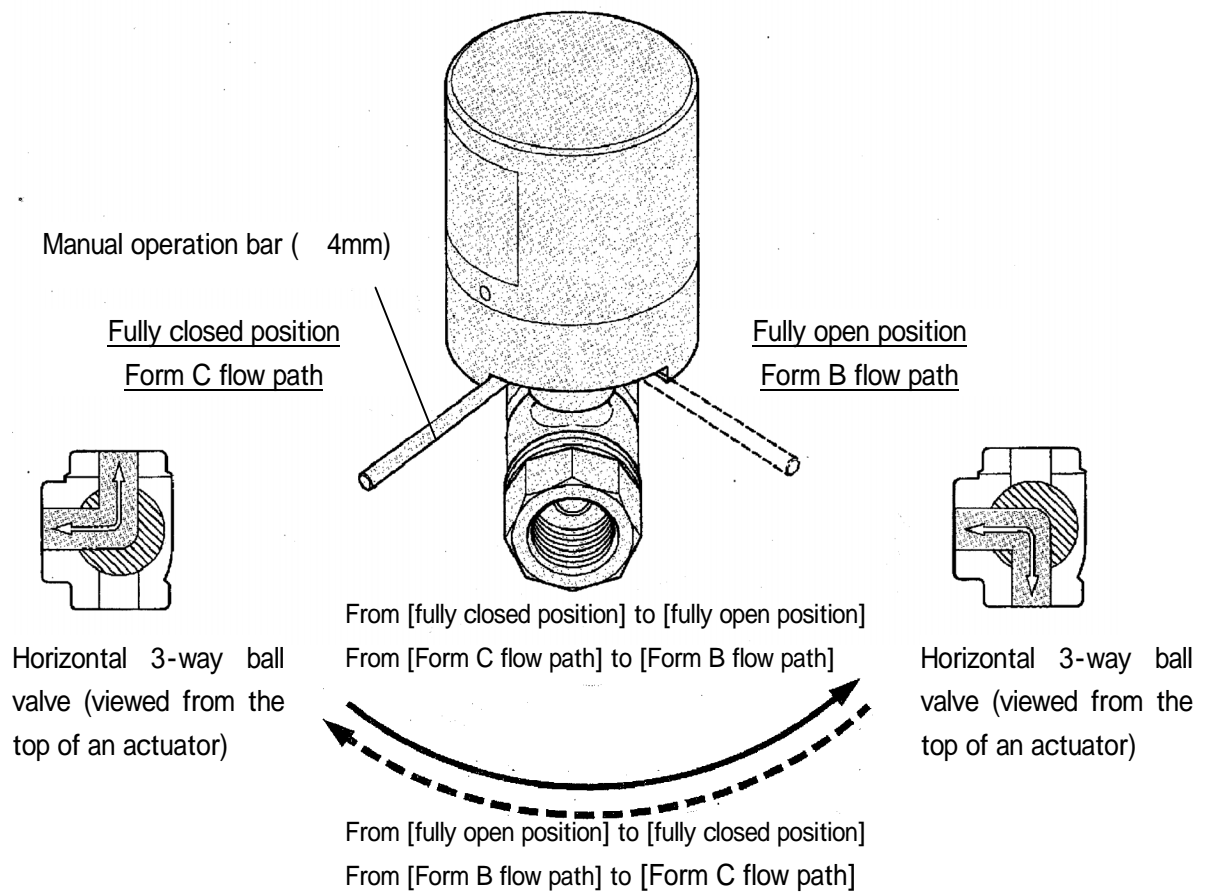

Fig.22 Position indicator for 3-way ball valves

Prepare a metal bar (4mm x 15cm) for manual operation. It is optionally available at KITZ distributors and agents.

Insert the manual operation bar into a hole provided on the bottom of an actuator housing, and rotate it by 90 ° , following the arrow marks shown in **Fig.22**, very slowly, taking some 20 seconds.

4-1-2. Manual operation of Type ED(B) 12/24 actuator, Size 2

A manual operation shaft is provided on the bottom of an actuator housing (Fig.23).

Slowly rotate the manual operation shaft (5.5mm x 5.5mm) with a wrench.

Fig.24 shows the top views of 2-way and horizontal 3-way ball valves driven by actuators. The fully open position [O], the fully closed position [S] and arrowed operating directions are indicated on the bottom of an actuator housing. Keep this in mind while reading the instructions given below.

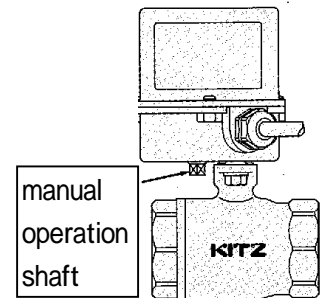
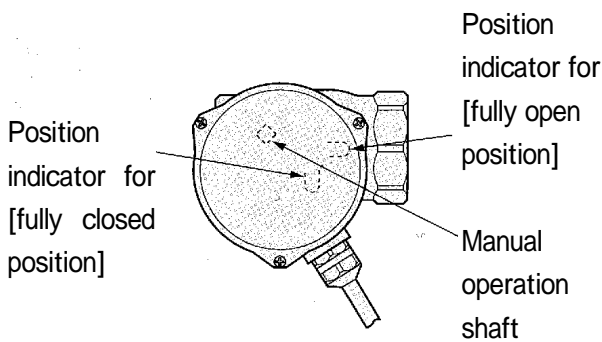

Fig.23

2-way ball valves



3-way ball valves

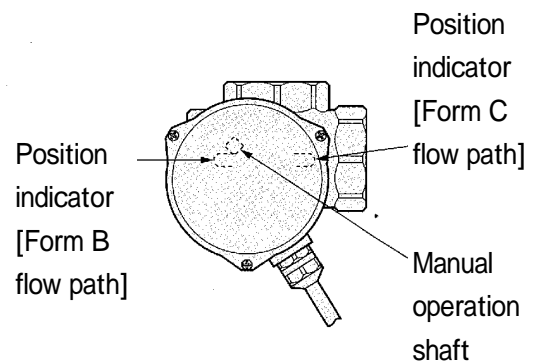

Fig.24 Valve Operating Positions

Operating 2-way ball valves from [fully closed position] to [fully open position]:

The red indicator is not visible when a valve is fully closed, while the manual operation shaft is positioned near the large [S] mark. Rotate the shaft clockwise by approximately **315°**, viewing from the top of an actuator, to fully open the valve. The shaft is now positioned near the large [O] mark.

Changing flow paths of horizontal 3-way ball valves from [Form C] to [Form B]:



The red indicator is visible near [Form C] indicator, when a valve is fully set to [Form C] flow path, while the manual operation shaft is positioned near the large [S] mark. Rotate the shaft clockwise by approximately **315°**, viewing from the top of an actuator, to reset the valve to [form B] flow path. The shaft is now positioned near the large [O] mark.

Operating 2-way ball valves from [fully open position] to [fully closed position]:

The red indicator is visible when a valve is fully open, while the manual operation shaft is positioned near the large [O] mark. Rotate the shaft counterclockwise by approximately 315° , viewing from the top of an actuator, to fully close the valve. The shaft is now positioned near the large [S] mark.

Changing flow paths of horizontal 3-way ball valves from [Form B] to [Form C] :

The red indicator is visible near [Form B] indicator, when a valve is set to [Form B] flow path, while the manual operation shaft is positioned near the large [O] mark. Rotate the shaft counterclockwise by approximately 315° , viewing from the top of an actuator, to reset the valve to [Form C] flow path. The shaft is now positioned near the large [S] mark.

 CAUTION	
	<ul style="list-style-type: none"> ● Caution for manual operation of Type ED12/24-1 or ED12/24-2 actuators. If the impedance of the control panel between Terminal in red and Terminal in black is lower than that of the motor, the electric current generated by the motor might increase the torque for manual operation of actuators. For easier manual operation, adjust the impedance of the control panel to be higher than that of the motor.

4-2. Electric Operation

Check that the power source voltage conforms with the design specification of an actuator.

Check that control circuits of an actuator are correctly wired, according to the wiring diagram indicated on an actuator housing and the color codes of wires

Turn on an actuator to detect if anything abnormal might happen. If anything abnormal such as smoke emission or failure of control circuit fuse happens, immediately turn off the actuator, detect the cause and take an appropriate corrective measure to solve the problem.

Operate an actuated valve electrically to open (or for Form B flow path) and then to close (or for Form C flow path) and check that it is correctly driven when position indicator lamps are used (voltage output), turn off the actuator at the fully open position (or at Form B flow path) and check that the lamp correctly lights. Take the same procedure to check that the lamp correctly lights at the fully closed position (or at Form C flow path) of the valve.

In case of motor overheating, smoke emission or fuse failure, turn off an actuator, detect the cause of failure and apply an appropriate corrective measure to solve the problem.

4-3. Operational Precautions

 **CAUTION**

- **Do not** use an actuator for intermediate valve opening or for control of valve flow rate. Ball valves are generally designed for full opening or full closing operations, and leaving them partly open will wear or deform ball seats and result in internal fluid leakage.
- **Do not** drive an actuator to continually open and close a valve. Pause for at least one second between opening and closing operations (**Fig.25**).

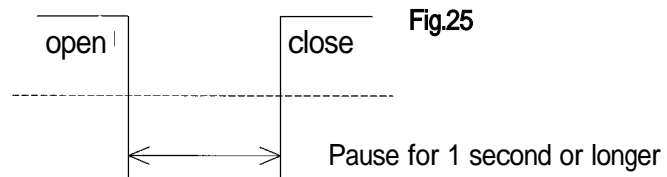

- **Do not** control an actuator with a solid-state relay (SSR). When the actuator is turned off, a leakage current may affect its function or affect its service life. If SSR must be used for any particular reason, ensure to test the actuator to check its proper activation prior to operation.
- **Do not** drive an actuator directly by contact output of a sequence controller. If such an activation is inevitable for any particular reason, drive the actuator by means of a switching element like a relay provided with an adequate contact capacity.
- **Do not** use an actuator for parallel operation of valves. It will generate an abnormal electricity and cause melting adhesion or damage of built-in switches, and damage of cams. For actuation of two or more valves with one actuator, provide a separate operation switch for each valve.
- This series of actuators is designed for technically non-critical applications, and electromagnetic waves and noises may affect its operation. For connection of this series of actuators with other equipment, which may cause electromagnetic waves and noises, ensure to check its proper operation before application.

⚠ CAUTION

- If opening/closing limit switches are connected with voltage output circuits like indicator lamps with a small output load current, contact resistance of a micro switch built in an actuator may become unstable, and cause an unstable actuator drive. To eliminate this problem, feed 50mA or higher load current to the limit switches.
- Ensure to provide a fuse or a short circuit breaker on the control panel to prepare for accidental short circuits.

Protective measures for extraordinary pressure rises

When a floating-ball type ball valve is used for highly volatile liquid service, rise of line temperature or ambient temperature may often cause an extraordinary rise of the pressure of the fluid left within a body cavity and result in seat damage or valve malfunction. This problem may be solved by the following preventive measures:

For fully closed valves:

Optional provision of a pressure equalization hole through the upstream side of the ball, or a pressure equalization groove on the upstream ball seat is recommended (Fig.26). This provision will make the fluid flow uni-directional, so that care must be taken to decide mounting direction of the valve on piping.

For fully open valves:

Standard provision of a pressure equalization hole on the top of the ball where it contacts with the valve stem is provided (Fig.27). Valve mounting orientation remains bi-directional.

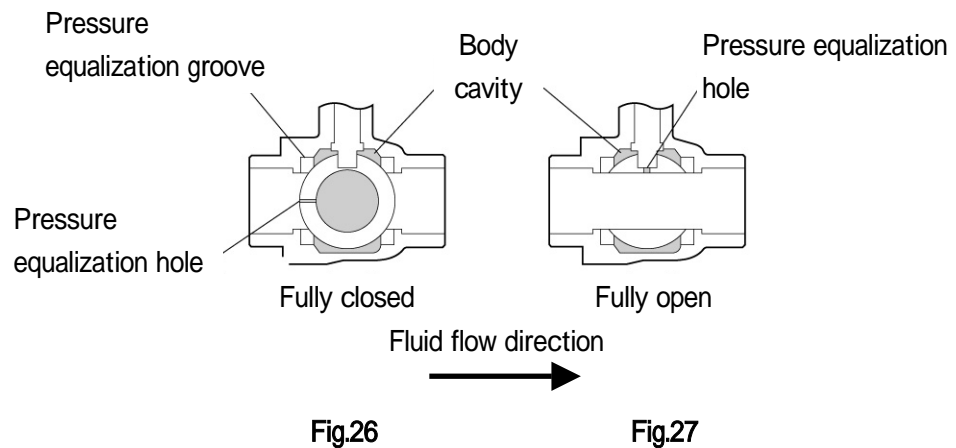



Extraordinary pressure rises also could be a problem for a valve mounted at the end of the piping loop for liquid service. No effective solution could be recommended for such a valve itself. The entire piping system needs an appropriate design reconsideration in advance so that a pressure relief valve may be installed or the piping loop may not be ended with a valve.

4-4. Maintenance and Inspection

Ball valves and actuators introduced in this manual are all designed lubrication-free.

Inspections of all actuated valves must be carried out periodically, and as frequently as possible to prevent accidental mishaps. Here are the items of inspections required as a minimum:

- (1) Check trouble-free opening and closing of valves.
- (2) Detect any external fluid leakage from valves and piping connections.
- (3) Check vibration of valves and piping during operation.
- (4) Inspect loosened bolts and nuts
- (5) Inspect loosened glands of valves such as KITZ valves coded UTGE.

 CAUTION	
	<ul style="list-style-type: none"> ● Foreign objects stuck to valve seats may result in generation of abnormal noises. Ensure to remove them immediately to prevent damage of seats and valve malfunctions. ● If external fluid leakage is detected from valve gland area (KITZ Valves coded UTGE, for example), retighten the gland immediately after having shut off the fluid flow. Do not tighten it excessively so that subsequent valve operation may not become difficult. ● Unusual vibration on piping may also cause failure or malfunction to actuated valves. Support the piping firmly to prevent or minimize such vibrations.

4-5. Dismantling and Reinstallation

For dismantling an actuated valve from piping, after having checked that there is no fluid residue left inside, use two wrenches as shown in **Fig.28**.

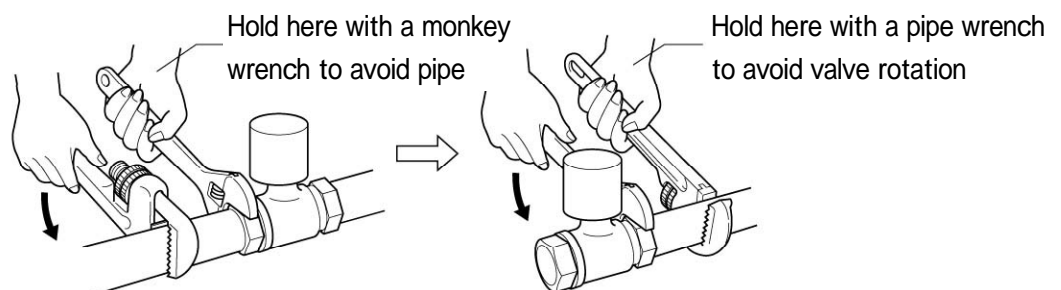









Fig.28

For reinstalling an actuated valve after maintenance, refer to Section 3 of this manual.

 WARNING	
	<ul style="list-style-type: none"> ● Do not disassemble an energized actuator from a valve, to eliminate concerns of valve damages and accidental mishaps.
	<ul style="list-style-type: none"> ● Do not put your fingers or foreign objects such as tools into a valve port, while checking valve opening positions, to avoid injuries and equipment damages.
	<ul style="list-style-type: none"> ● Before dismantling an actuated valve, ensure to equalize the pressure of the piping and the valve interior with the ambient pressure. Otherwise, residual pressure and line fluid may dangerously extrude from the valve bore and cause accidental mishaps.

 CAUTION	
	<ul style="list-style-type: none"> ● Factory-assembled actuated valves are all adequately adjusted for satisfactory function and performance. Do not disassemble them for any reason, unless approved in advance by KITZ Corporation, as it may cause valve malfunction, valve seat leakage and other technical problems.
	<ul style="list-style-type: none"> ● Maintenance works for dismantled valves must be carried out in dust-free, clean places to prevent intrusion of foreign objects into the interiors of valves and actuators. ● During maintenance works and dismantling from or reinstallation on piping, take care not to damage sliding parts of actuated valves such as shafts and stems, and prevent foreign objects from sticking to internal and external surfaces. ● For mounting 3-way ball valves on piping, check that the fluid flow direction matches to the operational direction of control circuits.

4-6. Trouble Shooting

The following table provides the general guidance of remedial and preventive measures to settle technical problems which may occur on site during operation of actuated ball valves. For further technical assistance, contact KITZ Corporation or your local KITZ distributors or agents.

	Categories of failures	Causes of failures	Remedial measures	Preventive measures	
No valve actuation	Actuator failures	Control circuit failure	<ul style="list-style-type: none"> Discrepant power supply 	<ul style="list-style-type: none"> Replacing actuators, if subjected to voltage higher than design specification 	<ul style="list-style-type: none"> Correct power supply
		Damaged or deteriorated actuator parts	<ul style="list-style-type: none"> Discrepant control circuitry Inadequate contact between terminals 	<ul style="list-style-type: none"> Replacing actuators, if corrective measures could not solve the problem 	<ul style="list-style-type: none"> Checking correct circuitry with operation manual. Correct and secured terminal connections
			<ul style="list-style-type: none"> Water intrusion into actuator interior Submerged actuator Improper mounting orientation Inadequate waterproofing for exposed ends of cables 	<ul style="list-style-type: none"> Replacing actuators 	<ul style="list-style-type: none"> No installation in an environment with risk of submerging Mounting with correct orientation Adequate waterproofing with gap fillers and plastic tapes
			<ul style="list-style-type: none"> Limit switch contact failure caused by parallel operation 	<ul style="list-style-type: none"> Replacing actuators 	<ul style="list-style-type: none"> Forbidding parallel operation
			<ul style="list-style-type: none"> Limit switch contact failure caused by induction load 	<ul style="list-style-type: none"> Replacing actuators 	<ul style="list-style-type: none"> Proper selection of load in consideration of contact capacity Providing contact protection elements Forbidding parallel operation
			<ul style="list-style-type: none"> Damaged cams 	<ul style="list-style-type: none"> Replacing actuators 	<ul style="list-style-type: none"> Proper selection of load in consideration of contact capacity Forbidding parallel operation

(To be continued)

		Categories of failures	Causes of failures	Remedial measures	Preventive measures
No valve actuation	Valve failures	Excessively high valve operation torque*1	· Excess pressure rise of valve cavity or piping pressure	· Replacing valves, if pressure reduction could not solve the problem	· Prevention of excessive body cavity or piping pressure, referring to the valve operation manuals
			· Pipe sealing materials stuck to valve seats	· Replacing valves	· Proper, non-excessive application of sealing material
			· Foreign objects stuck to valve seats	· Replacing valve seats, or valves	· Mounting a strainer on the upstream piping · Sufficient care for piping flush before a loop test
			· Corroded ball	· Replacing balls, or valves	· New materials suitable for line fluid
			· Stem galling	· Replacing stems, or valves	· New materials suitable for line fluid
Abnormal valve actuation	Actuator failures	Nonconformance with designed service conditions	· Excessively frequent valve operation	· Replacing actuators, if improved service conditions could not solve the problem	· Minimum 1 second pause between valve actuations
			· Too high or low ambient temperature		· Ambient temperature within a range of design specification
	Improper circuitry	· Valve operation in parallel	· Replacing actuators or products	· Forbidding parallel operation · New circuitry with relays additionally provided	
	Valve failures	Excessively high valve operation torque	· Refer to *1	· Refer to *1	· Refer to *1

5. Product Warranty

Failed or damaged products shall be repaired or replaced at no cost to users, if the failure or damage occurred within 12 months after pilot operation, but not exceeding 18 months after shipment from KITZ factories, while the following conditions are satisfied:

- (1) The product has been correctly handled, stored, installed, operated and maintained according to this manual within the scope of design specifications and service conditions of the product.
- (2) Failure or damage of the product has not been caused as a result of the user's incorrect operation or lack of care.
- (3) The product has not been damaged due to an act of God or a natural disaster.
- (4) The product has not been modified by any party other than KITZ Corporation or its authorized modification shops.
- (5) The product function and performance has not been deteriorated by aging.