KITZ

Operation Manual

For
Floating Type Ball Valves

(Conform to ISO5211, Flanged Ends)

Thank you for having chosen KITZ products.

For safe and trouble-free function and performance of the product, ensure to read and understand all items of this manual before valve mounting and operation.

Keep this manual in a convenient place for your valve operators' easy access.

This manual applies to the KITZ flanged ends floating type ball valves.

This manual is prepared for manual valve operation.

For electric or pneumatic valve operation, refer to the operation manual prepared by the manufacturers of relevant valve actuators.

CAUTION AND WARNING

To ensure safe and trouble-free function and performance, please read all the contents of this manual before handling, transportation, mounting and operation of valves. Keep this manual to the place accessible to the operator.

The signal words "WARNING" and "CAUTION" are defined as follows:



Indicating potentially hazardous conditions which may result in serious injury to personnel, if such warnings shall be ignored.



Indicating potentially hazardous conditions, which may result in injury to personnel or only property damage, if such cautions shall be ignored.



Indicate prohibition of an action.



Indicate mandatory implementation of an action.

NOTES TO USERS

This manual covers the normal usage of the product. Technical data and instructions for operation, maintenance and inspection of the product are prepared in consideration of safety. However, they are good only to cover typical applications as a general guideline to users. If technical assistance beyond the scope of this manual is required, contact KITZ Corporation or its distributors.

The illustrations given in this manual do not introduce all details. If more detailed data are needed, refer to our relevant valve assembly drawings.

Any information provided in this operation manual is subject to revision at any time without notice. This edition cancels all previous issues.

C O N T E N T S

	Sheet
Construction and Design Features	1
Valve Operating Device	4
Transportation and Storage	7
Valve Installation	10
Valve Operation	15
Periodic Inspection	20
Disassembly and Reassembly	24

CHAPTER
Construction and Design Features

Construction and Design Features

1. Construction and Design Features

1.1 The typical valve design is as illustrated below.

1.2 The rotation of the stem by 90 ° fully opens or closes of the valve.

1.3 Valves are serviceable only in fully open or closed position.

1.4 The ball is hold with two ball seats placed in the valve body and body cap.

The upstream pressure pushes the ball, which compresses the down stream side ball seat to completely shut off the fluid flow.

1.5 Fluid can flow through valve port in both directions.

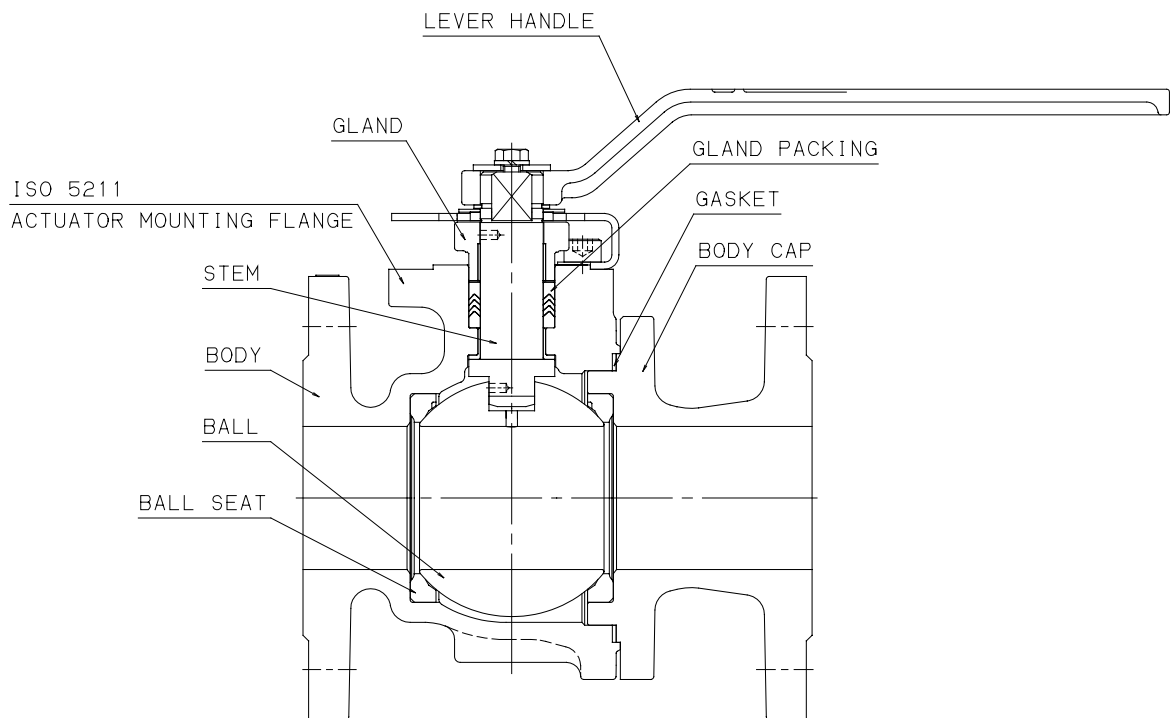

This illustration introduces a typical construction.

Construction and Design Features

2. Design Features

2.1 Stem Blowout Proof

The lower end of the stem is designed with an integral collar to be stem blowout proof. It also functions as the back seat to minimize the external leakage from the stem area, if the gland packing is deteriorated by a plant fire.

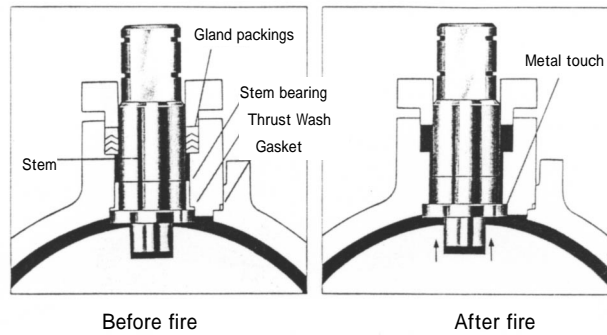

2.2 Body Seal

The metal-to-metal body seat as the secondary body seat minimize the external leakage, if the non-metallic gasket is deteriorated by a plant fire.

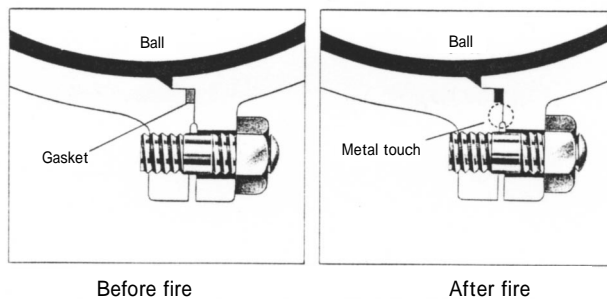

2.3 Integral Seat

The integral seats on the body and body cap minimize the internal leakage, if the non-metallic ball seats are deteriorated by a plant fire.

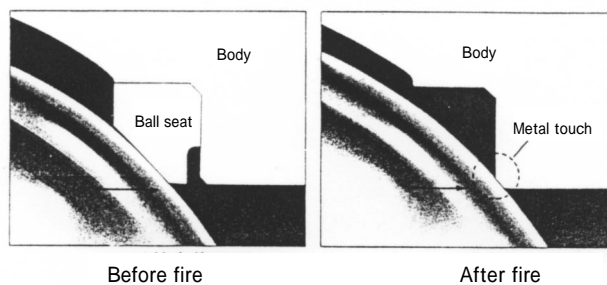

CHAPTER
Valve Operating Device

Valve Operating Device

1. Lever Handle

1.1 The lever handle is directly mounted on the valve stem.

1.2 Rotation of the lever handle by 90 ° fully opens and fully closes the valve.

Turning the lever clockwise closes the valve, and turning the lever counterclockwise opens the valve.

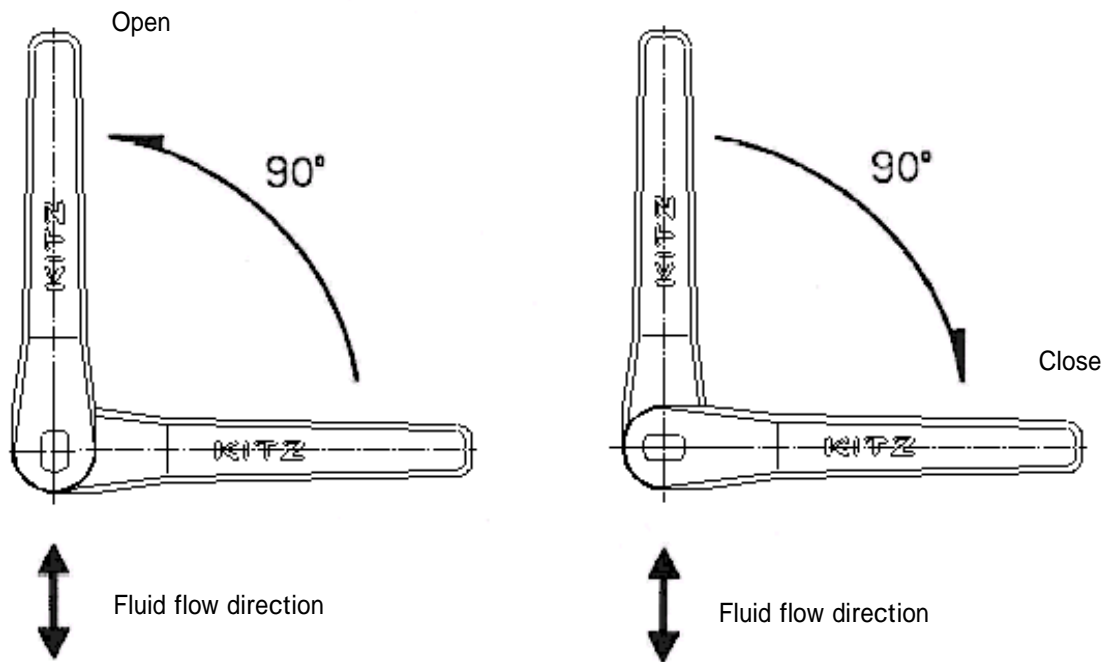

1.3 Rotation of the stem by 90 ° fully opens and fully closes the valve for Bare Stem Type.

An appropriate tool or handle shall be applied to operate the valve and the flow direction shall be checked by the top orientation of stem.

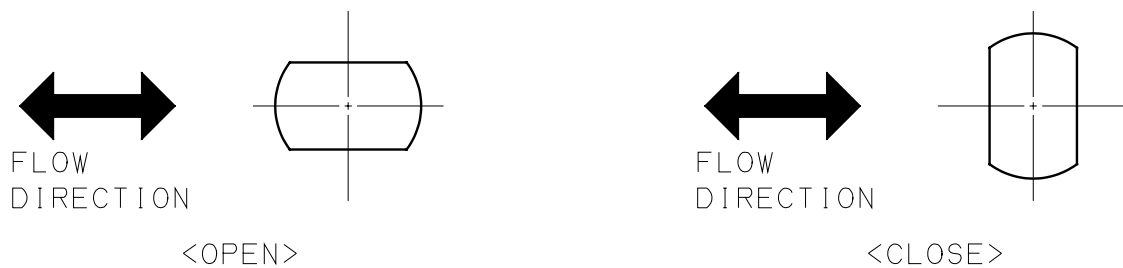

Valve Operating Device

2. Worm Gear Operator

2.1 The worm gear operator is mounted on the valve. Refer to the approval drawing for the position of the handwheel.

When re-orientation of worm gear operator is required, it shall be specified in the purchase order and take advice from KITZ Corporation.

2.2 According to the arrow or letter on the handwheel, turning the handwheel clockwise closes the valve, and turning the handwheel counterclockwise opens the valve.

2.3 Handwheel operating torque depends on the size of valves, the direction for opening or closing, pressure in piping, and the tightening condition of the gland packing.

2.4 Worm gear operator is to transmit a large torque to valve stems, converting a torque from drive shaft by means of reduction gearing unit using worm gears.

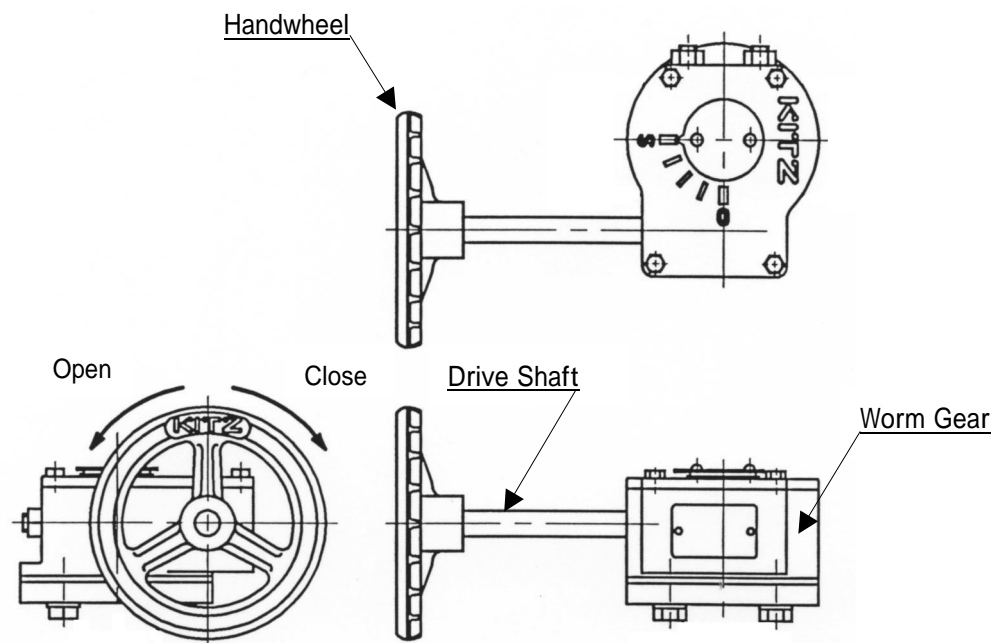





CHAPTER
Transportation and Storage

Transportation and Storage

1. Transportation

1.1 Cautions for Safety

 WARNING	
	(1) Keep off the valve lifting area to prevent personal injury caused by unsecured valves.

 CAUTION	
	<p>(1) Take care not to damage painting surface of valves during transportation, which may subsequently cause corrosion and get the valve rusty. If the valve is damaged, touch up paintings should be done.</p> <p>(2) Take care the handling and storage of the carton packed product. The high humidity may damage the cartons.</p>

1.2 Transportation

1.2.1 Keep packages as they are delivered just before installation.



If the protective covers are found missing during transportation, provide appropriate type of protective covers.

1.2.2 Handle valves carefully so that they may not fall or drop on the ground. Any extraordinary mechanical impact should be avoided.

Transportation and Storage

2. Storage

2.1 Cautions for Safety

 CAUTION	
	<p>(1) DO NOT store valves in a corrosive environment, which may cause corrosion on threaded portions of valves.</p> <p>(2) DO NOT remove protective covers until installation. This will prevent the intrusion of any foreign object which could cause damage to the closure elements such as ball and seats.</p> <p>(3) DO NOT place any other objects on valves, and DO NOT step on them. Overloading may damage valves.</p> <p>(4) DO NOT carelessly pile up products to avoid risk of product damage and personal injury caused by unstable piling.</p>
	<p>(5) Keep the valves in the open position during storage. Storing the valves in halfway position may deform the ball seats, leading to the internal leakage.</p>

2.2 Storage

2.2.1 Store valves at a dust-free, low humidity and well ventilated places.

Indoor storage is recommended.

2.2.2 Storage of valves directly on the ground or concrete floor is not recommended.



2.2.3 Take appropriate measures to prevent valves from direct exposure to dust, rain and sunlight, if valves would be stored outdoors.



CHAPTER
Valve Installation

Valve Installation

1. Flange Type

1.1 Cautions for Safety

 WARNING	
	<p>(1) The sealing materials determines the characteristic of service fluid and service range of pressure and temperature. Check the valve specifications with the catalogs and/or the attached nameplate. Services beyond the valve specifications may cause fluid leakage and valve malfunctions.</p>
	<p>(2) DO NOT install for pipe end service, which may cause the external leakage. In such a case, use a blank flange to prevent the leakage.</p>

 CAUTION	
	<p>(1) Keep a secure footing for valve installation and operation.</p> <p>(2) Sufficient lighting should be prepared for valve operation.</p> <p>(3) Piping should be properly supported, if needed.</p>

1.1.1 Allow sufficient room for safe and easy operation, installation and subsequent maintenance of valves.



1.1.2 For smooth operation, inspection and maintenance, take appropriate measures for valves which are forced to be installed in small places.



1.1.3 Try not to install valves in the places where valve functions may be hampered by such outer forces as vibrations and others.

1.1.4 It is recommended to install valves on horizontal piping in a upright position.

Valve Installation

1.2 Cautions for Safety

 WARNING	
	(1) Keep off the valve lifting area to prevent personal injury caused by unsecured valves.

 CAUTION	
	<ol style="list-style-type: none">(1) Take care not to catch fingers in flanges during mounting work.(2) Take care not to damage flanges, ball and ball seats surfaces.(3) Pipes should be properly supported, if needed.(4) Retighten the gland bolts before operation. Packing tightening pressure may be lowered due to the stress relaxation which may take place during transportation and storage, leading to the occurrence of leakage through the gland area.(5) Be sure to insert new gaskets for valve mounting.

Valve Installation

1.2.1 Check the following items before valve mounting:

- (1) Service conditions should be within the valve specifications.
- (2) Valve flanges should correspond with piping flanges.
- (3) Gasket contact surfaces of pipes and valve flanges must be thoroughly inspected to make sure no scratch or any other indication of flaw is found.
- (4) The appropriate length should be kept between pipe flanges for the valve face-to-face dimensions including gasket thickness.
- (5) The valve and pipe center should be aligned accurately.
- (6) Bolt holes of flanges should be arranged symmetrically such that they are lined up against the center line of flanges.

1.2.2 Before installation, the connecting pipes should be cleaned to remove any foreign object such as sand, dust and welding spatters from the connecting pipe interior.

1.2.3 Handle valves carefully so that they may not fall or drop on the ground. Any extraordinary mechanical impact should be avoided.

1.2.4 Remove flange covers from valves just before installation..

1.2.5 Check all threaded areas after installation and retighten them, if needed.

1.2.6 Piping should be flushed before test operation, with valves open, to assure removal of any foreign object that could damage valves.

DO NOT operate valves during flushing.

Valve Installation

1.3 Installation Procedures

- 1.3.1 Make sure that pipes are aligned accurately.
- 1.3.2 The length between piping flanges should correspond with the valve face-to-face dimensions including gasket thickness.
- 1.3.3 Insert the valve between pipe flanges. Thread bolts through bottom bolt holes and tighten bolts lightly.
- 1.3.4 Insert gaskets between valve and pipe flanges. It is recommended to apply the gasket paste to gasket faces.

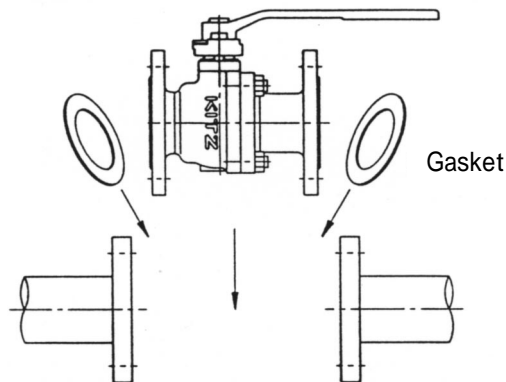

- 1.3.5 Make sure the correct alignment of gaskets, which are held by bottom bolts between valve and pipe flanges.
- 1.3.6 Thread bolts through the other bolt holes and tighten them lightly.
- 1.3.7 Tighten bolts evenly, gradually and alternately in a star pattern as shown below. The ends of all tightened bolts should protrude equally beyond the nuts.

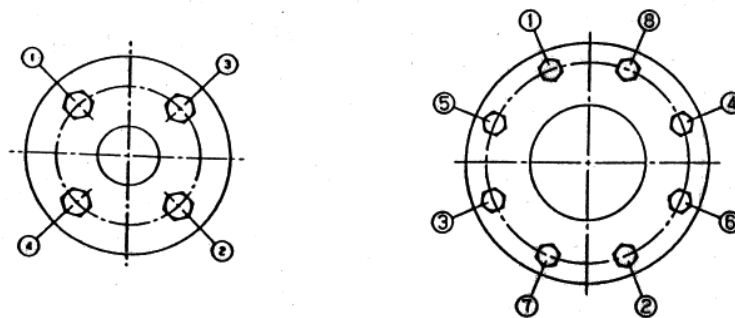



- 1.3.8 Raise the line temperature and pressure gradually on test operation. Retighten the threaded portions, if needed.

CHAPTER
Valve Operation

Valve Operation

1. Cautions for Safety

 CAUTION	
	<p>(1) DO NOT apply excessive torque by using a pipe or any other device to operate the valve.</p> <p>(2) DO NOT loosen bolts and nuts of gland and flange area of pressurized valves.</p> <p>(3) Avoid the services in intermediate position for long period, which may damage ball seats and cause seat leakage.</p>
	<p>(4) Retighten the gland bolts and nuts before operation of the valve. Check a handle torque while retightening the bolts and nuts so that the operation won't become too difficult due to over-tightening. The gland bolts should be alternately tightened with an even force.</p> <p>(5) Valve should be kept fully open during the line test or pressure test. The ball seats may be deformed, if the valve is fully closed during test. Possible internal through-bore leakage may occur under such conditions.</p> <p>(6) When service temperature fluctuates, retighten the gland bolts and nuts after the temperature is stabilized in preparation for the occurrence of stress relaxation of the gland packing.</p> <p>(7) Open the valve gradually to prevent damages of pipes, when the valve handles high temperature fluid such as steam.</p> <p>(8) Take appropriate measures to prevent freezing, as needed.</p>

2. Operation

2.1 Lever handle

Rotation of the lever handle by 90 ° fully opens and fully closes the valve.

To close the valve, turn the operating handle clockwise according to the letters and the mark indicating the direction. Counterclockwise rotation will open the valve.

2.2 Worm gear operator

According to the arrow or letter on the handwheel, turning the handwheel clockwise closes the valve, and turning the handwheel counterclockwise opens the valve.

Valve Operation



3. Daily Inspection

In order to operate your valves safely and satisfactorily, daily inspection is very important. Here are the inspection items.

Items to be Inspected	Areas to be inspected	Inspection Method	Remedial Measure
External leakage	Gland area	Visual check With soap solution	Retighten gland bolts. Replace the gland packing.
	Flange areas	Visual check With soap solution	Retighten flange bolts. Replace gaskets.
	Threaded areas	Visual check With soap solution	Retighten each threaded areas. Replace the parts as needed.
	Body and Body Cap surface	Visual check With soap solution	Replace the valve.
Abnormal noises	Valve body	Auditory check	Consult a piping engineer.
	Loosened bolts	Auditory check	Retighten bolts.
	Pipe vibration	Auditory check	Consult a piping engineer
Loosened bolts and nuts	Bolts and nuts	Visual check Tactile check	Retighten bolts and nuts.
Internal thru-bore leakage			Remove the foreign object. Disassemble and inspect the valve components. (Replace the ball seats) Replace the valve.
Valve operation	Valve operating position	Visual check	Make sure that the valve is in predetermined position.
	Disturbed operation	Tactile check Auditory check	Disassemble and inspect the valve components.

Valve Operation

4. Remedial Measures

 CAUTION	
	(1) Wear the protective items such as goggles, gloves and working boots. (2) Take safety measures against toxic, flammable or corrosive fluids. (3) Reduce the line pressure to the atmospheric level before retightening gland and flange bolts and nuts. (4) Operators should take protective measures to prevent direct exposure to the fluid, when the fluid spouts out from flange areas. (5) Reduce the line pressure to the atmospheric level, when the packing and gaskets are replaced or bolts and nuts are loosened. Operator should take protective measures to prevent direct exposure to the fluid, when the fluid spouts out from valves.
	(6) DO NOT apply the lubricant to the pipes and valves which handle oxygen.

4.1 Leakage from the Gland Area

Retighten the gland bolts or nuts if the leakage from this area is detected . Evenly tighten the bolts or nuts alternately as shown below. Adequate torque should be applied when retightening the bolts or nuts so that the valve operation won't become difficult. If it does not stop the leakage, the packing rings should be replaced.

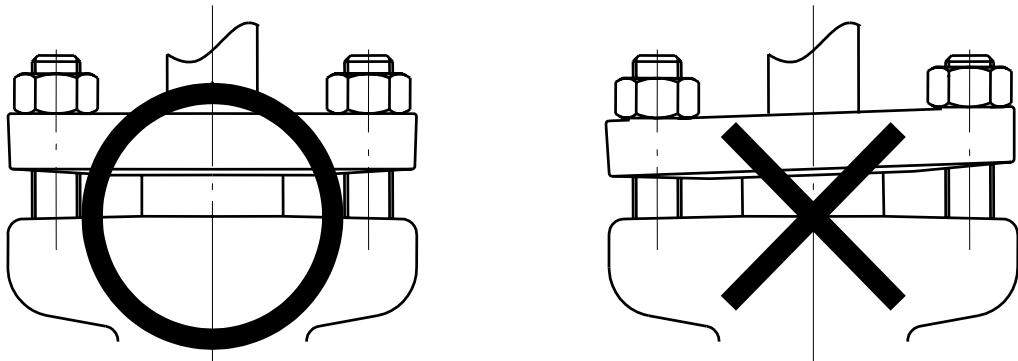

4.2 Leakage from the Flange Area

Tighten bolts evenly, gradually and alternately in a star pattern as shown below..

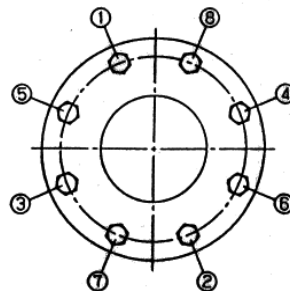

Valve Operation

5. Troubleshooting

Defect	Possible causes	Remedial measure
Disturbed valve operation	Foreign objects may have choked up the valve body cavity and stuck around the ball seats.	Disassemble and inspect the valve components.
Excessive valve torque	Foreign objects may have stuck to the stem.	Remove the foreign objects and check the valve.
	Foreign objects may have choked up the valve body cavity and stuck around the ball seats.	Flush the valve bore with the fluid with the valve slightly open to remove the built-up objects or disassemble and inspect the valve.
	The gland bolts may have been overly tightened.	Once loosen the gland bolts and adequately retighten them to an extent that the leakage does not occur.
Leakage from the gland area	Loose gland bolts.	Retighten the gland bolts.
	Uneven tightening of the gland bolts.	Once loose the bolts and evenly retighten them.
	Damage on the gland packing.	Replace the gland packing.
Internal through-bore leakage	Damage on the ball seats.	Disassemble and inspect the valve .Replace ball seats.
Abnormal noise or vibration	Loose bolts and nuts.	Retighten the bolts and nuts.

CHAPTER
Periodic Inspection

Periodic Inspection

1. Periodic Inspection



- 1.1 Carry out the periodic inspection on the valve in use at least once a year
- 1.2 Examine the valve to ensure the smooth operation and sufficient function.
- 1.3 See Chapter "Valve Operation" for inspection items and inspection methods.
- 1.4 Where valves and adjoining piping are not inspected daily or not operated for a long period, a periodic inspection is also recommended. (A periodic inspection should be carried out on all valves.)
- 1.5 It is particularly important to thoroughly check the valves used for the following service :
 - a) Where performance failure of valves could result in a major shutdown of an entire plant unit.
 - b) Where the clogging of pipes with the fluids is likely to occur.
 - c) Where corrosion or/and wear by the fluids is expected.
- 1.6 It is recommended to replace the gland packing at the time of periodic inspection.



2. Inspection and Maintenance

In case pipelines or facilities where valves are installed are shut down for the pipeline inspection, remove the valves from the pipelines and perform the body and seat pressure tests as well as operation tests, if needed. If any defect is found, disassemble the valves for further inspection. The valves must pass required inspections before being sent back to the pipelines or facilities for reinstallation.

Periodic Inspection

2.1 Care for the removal from and installation to pipelines of valves.

 WARNING	
	<p>(1) Discharge the fluid from the pipes and reduce the line pressure to atmospheric level when disassembling valves. Trapped pressure of fluid is very dangerous and could cause accidents resulting in personal injury. In case of installation of pipe end service, the fluid might enclose between the valve and the blank flange. Open the valve and discharge the fluid from the pipe before the blank flange removal.</p> <p>(2) Discharge the fluid and pressure trapped within the valve body with the valve intermediate position before disassembling.</p> <p>(3) In case fluid is toxic, inflammable or corrosive, remove the fluid completely from pipes and internal valves.</p> <p>(4) Take protective measures to prevent direct exposure to the fluid and catching fire.</p> <p>(5) Keep off the working area to prevent personal injury if valves are installed at higher places.</p>

 CAUTION	
	<p>(1) Wear the protective items such as goggle, gloves and working boots.</p> <p>(2) Keep a secure footing for valve dismantle and installation.</p> <p>(3) Piping and valves should be properly supported, if needed.</p> <p>(4) Before dismantling valves from the pipeline, mark the valve end flanges and coupled pipe flanges with their original positions. Reinstall the valve on pipes according such marks after reassembly.</p> <p>(5) Be sure to insert new gaskets for valve mounting</p>

2.2 Disassemble & Assemble

Refer to Chapter VII for assembly and disassembly procedure.

Periodic Inspection

2.3 Test and Inspection



Refer to the following procedure for test and inspection.

2.3.1 Operation Test

- (1) Check smooth operation of valves without galling or sticking of internal valve components.
- (2) Check that the stem is firmly assembled with the ball.
- (3) Ensure that there should be no offset of the ball port and ball seats in the fully open position. The ball should not be protruded into the valve port other than the rounded surface of the ball port edges.

2.3.2 Shell Test and Seat Leakage Test

- (1) Care for shell test and seat leakage test.

 CAUTION	
	<ol style="list-style-type: none">(1) Wear the protective items such as goggle, gloves and working boots.(2) Take sufficient precautions before shell test and seat leakage test for operators safety.

- (2) Shell Test and Seat Leakage Test

All valves are subjected to a hydrostatic or pneumatic shell test and seat leakage test at the required test pressure after assembly.



Refer to the JIS B2003, JPI-7S-39 or API-598 for test methods.



CHAPTER
Disassembly and Reassembly

Disassembly and Reassembly

1. Disassembly

1.1 Cautions for Safety

 WARNING	
	(1) Operator must take protective measures to prevent direct exposure to the fluid or catching fire.

 CAUTION	
	(1) Wear the protective items such as goggle, gloves and working boots. (2) Take care not to catch fingers in flanges during disassembly. (3) When disassembling valves of large sizes, use an appropriate machine to lift up valves.

1.2 Before Disassembly

1.2.1 Disassemble the valve at dust-free place.

1.2.2 Take care not to damage the flange surfaces, ball and stem.

1.2.3 Give identification marks on edges of the coupled flanges for adequate and easy coupling of the body cap on subsequent reassembly.

Disassembly and Reassembly

1.3 Disassembly procedure

Note: see sheet 31/31 for reference figure.

1.3.1 Full close the valve.

《Disassembly procedure for lever handle operated valve》

1.3.2 Remove the handle lock plate bolt (123A) and handle lock plate (43), handle (9) or handle head (9B) from the stem (3).

In case of the handle head type (9B), Remove the handle bolt (123B) and handle bar (9A) from the handle head (9B).

1.3.3 Remove the snap ring (48) and key lock plate (40) stopper (49) from the stem (3).

1.3.4 Remove the stopper plate bolts (126) and stopper plate (51) from the body (1).

1.3.5 To Common 1.3.9 .

《Disassembly procedure for gear operated valve》

1.3.6 Remove the bolts (99) and gear unit (102) with bracket (93) from the body (1)

1.3.7 Remove the connector (92) from the stem (3) or gear unit (102) .

1.3.8 To Common 1.3.9 .

《Common》

1.3.9 Remove the cap nuts (33).

1.3.10 Disassemble the body (1) and body cap (2).

1.3.11 Remove the gasket (19) from the body (1) or body cap (2).

1.3.12 Remove the ball(4) from the body (1).

1.3.13 Remove the gland bolts (36) to disassemble the gland (7).

1.3.14 Remove the coned disc springs (145) from the gland bolts (36).

1.3.15 Remove the gland bush (58) from the gland (7).

1.3.16 Remove the stem(3) from inside the body (1).

Disassembly and Reassembly

1.3.17 Remove the stem bearing (67) from the stem (3) or body (1).



1.3.18 Remove the ball seats (30) from the body (1) and body cap (2).

1.3.19 Remove the gland washer (58), gland packing (8) and packing washer (20) (Up to size 1 1/4) from the body (1).

Disassembly and Reassembly

2. Reassembly procedure

2.1 Caution for reassembly

 CAUTION	
	<p>(1) Wear the protective items such as goggle, gloves and working boots.</p> <p>(2) No open flame or smoking should be allowed in the working area.</p> <p>(3) Take care not to catch fingers in flanges during assembly.</p> <p>(5) Replace the gland packing, gasket and O-ring with new ones to ensure satisfactory sealing performance. Reuse of these components may cause leakage.</p> <p>(5) When assembling valves of large size, use appropriate machine to lift up valves.</p>
	<p>(6) DO NOT apply the lubricant to valve wet areas, when the valves handle oxygen.</p>

2.2 Before reassembly

- 2.2.1 Check all parts before reassembly. If any unsatisfactory function is found, replace the valve.
- 2.2.2 The consumables such as ball seats, gland packing, gasket, o-rings, stem bearing and etc. should be prepared before reassembly.
- 2.2.3 Clean all parts for reuse to thoroughly remove dust and other foreign objects.
- 2.2.4 Assemble the valve in a dust-free place.
- 2.2.5 Take care not to damage the flange surfaces, ball, ball seats and stem.
- 2.2.6 Ensure to assemble the valve in accordance with the marks given during disassembly.
- 2.2.7 Keep in mind all bolts, nuts and plugs should be securely tightened.

Disassembly and Reassembly

2.3 Reassembly procedure

Note: see sheet 31/31 for reference figure.

2.3.1 Assemble the stem bearing (67) to the stem (3).

2.3.2 Insert the stem (3) from inside the body (1).

Make sure that the stem collar contacts the body, and set the stem (3) in fully closed position of the valve.

2.3.3 Assemble the coned disc springs (145) to the gland bolts (36).

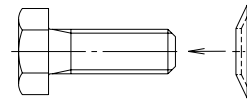

2.3.4 Assemble the gland bush (58) to the gland (7).

2.3.5 Mount the packing washer (20) (Up to size 1 1/4), gland packing (8), gland washer (58) and Gland (7) in the body (1), temporary tightening the gland bolts (36).

2.3.6 Mount the ball seats (30) in the body (1) and body cap (2).

2.3.7 Mount the ball (4) in the body (1).

2.3.8 Mount the gasket (19) to the body (1).

2.3.9 Mount the body cap (2) to the body (1).

Make sure to place the ball seat (30) in the correct position without dropping them from the body(1) and body cap (2).

2.3.10 Fasten the body (1) and body cap (2) with the cap bolts (33).

Evenly tighten the cap bolts (33) alternately and gradually in a star pattern. Once the bolts are properly tightened, the end of the bolts should evenly protrude beyond the nuts.

2.3.11 Tighten the gland bolts (36) adequately for trouble-free operation.

《Assembly procedure for lever handle operated valve》

2.3.12 Mount the stopper plate (51) to the body (1) and fix it with the stopper plate bolts (126).

2.3.13 Mount the stopper (49) and key lock plate (40) in the stem (3) and fix it with the snap ring (48).

Disassembly and Reassembly

2.3.14 Mount the handle (9) or handle head (9B) and handle lock plate (43) in the stem (3) and fix it with the handle lock plate bolt (123A).

In case of the handle head type (9B), Mount the handle bar (9A) in the handle head (9B) and fix it with the handle bolt (123B).

《Assembly procedure for gear operated valve》

2.3.15 Mount the connector (92) to the stem (3).

2.3.16 Mount the gear unit (102) with bracket (93) to the body (1) and fix it with the bolts (99).

All threaded areas should be securely tightened. Retighten them, if found loosened.

Disassembly and Reassembly

3. Cross-sectional assembly drawing

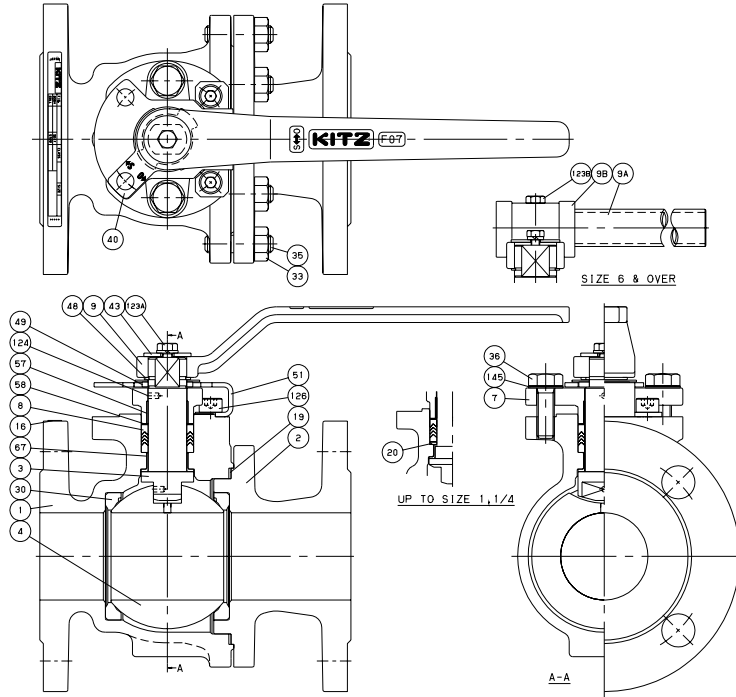

No.	Parts Name
1	Body
2	Body Cap
3	Stem
4	Ball
7	Gland
8	Gland Packing
9	Lever Handle (Up To Size 5)
9A	Handle bar (Size 6& Over)
9B	Handle Head (Size 6& Over)
16	Name Plate
19	Gasket
20	Packing Washer (Up To Size 1.1/4)
30	Ball Seat
33	Cap Nut
35	Cap Bolt
36	Gland Bolt
40	Key Lock Plate
43	Handle Lock Plate
48	Snap Ring
49	Stopper
51	Stopper Plate
57	Gland Bush
58	Gland Washer
67	Stem Bearing
123A	Handle Lock Plate Bolt
123B	Handle Bolt (Size 6& Over)
124	Spring & Pin
126	Stopper Plate Bolt
145	Coned Disc Spring

This illustration introduce a typical construction for lever handle operated valve.

Refer to the approval drawing before disassembly and assembly.

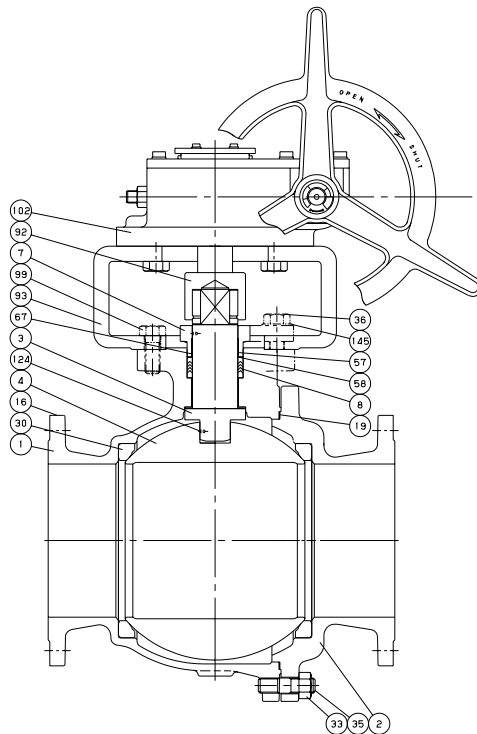

No.	Parts Name
1	Body
2	Body Cap
3	Stem
4	Ball
7	Gland
8	Gland Packing
16	Name Plate
19	Gasket
30	Ball Seat
33	Cap Nut
35	Cap Bolt
36	Gland Bolt
57	Gland Bush
58	Gland Washer
67	Stem Bearing
92	Connector
93	Bracket
99	Bolt
102	Gear Unit
124	Spring & Pin
145	Coned Disc Spring

This illustration introduce a typical construction for gear operated valve.

Refer to the approval drawing before disassembly and assembly.