KITZ

Operation Manual

For
Floating Type Ball Valves

(Threaded)

Thank you for having chosen KITZ products.

For safe and trouble-free function and performance of the product, ensure to read and understand all items of this manual before valve mounting and operation.

Keep this manual in a convenient place for your valve operators' easy access.

This manual applies to the KITZ threaded floating type ball valves.

This manual is prepared for manual valve operation.

For electric or pneumatic valve operation, refer to the operation manual prepared by the manufacturers of relevant valve actuators.

CAUTION AND WARNING

To ensure safe and trouble-free function and performance of the product, please read all items of this manual before handling, transportation, mounting and operation of valves. Keep this manual in a convenient place for your valve operations' easy access.

The signal words "WARNING" and "CAUTION" are defined as follows:



Indicates a potentially hazardous situation which, if not avoided, will result in death or serious injury.



Indicates a potentially hazardous situation which, if not avoided, could result in minor or moderate injury.

NOTES TO USERS

This manual covers the normal usage of the product. Technical data and instructions for operation, maintenance and inspection of the product are prepared in consideration of safety. However, they are good only to cover typical applications as a general guideline to users. If technical assistance beyond the scope of this manual is required, contact KITZ Corporation or its distributors.

The illustrations given in this manual do not introduce all details. If more detailed data are needed, refer to our relevant valve assembly drawings.

※ Any information provided in this operation manual is subject to revision at any time without notice. This edition cancels all previous issues.

C O N T E N T S

	Sheet
I Construction and Design Features	1/25
II Valve Operation Device	3/25
III Shipping, Handling and Storage of Valves	5/25
IV Valve Installation	8/25
V Valve Operation	13/25
VI Periodic Inspection and Maintenance of Valves	17/25
VII Disassembly and Reassembly of valves	21/25

CHAPTER I

Construction and Design Features

I Construction and Design Features

1. Construction and Design Features

1.1 The typical valve design is as illustrated below.

1.2 Range of operation from full opening to full closing is 90° .

1.3 These ball valves are designed for use in the full open or full closed position only.

1.4 The ball is supported by both ball seats. When the valve is pressurized, the ball moves against the downstream seat to complete the seal, shutting off flow of the line fluid.

1.5 This ball valve design may be used on applications where a bi-directional flow is needed.

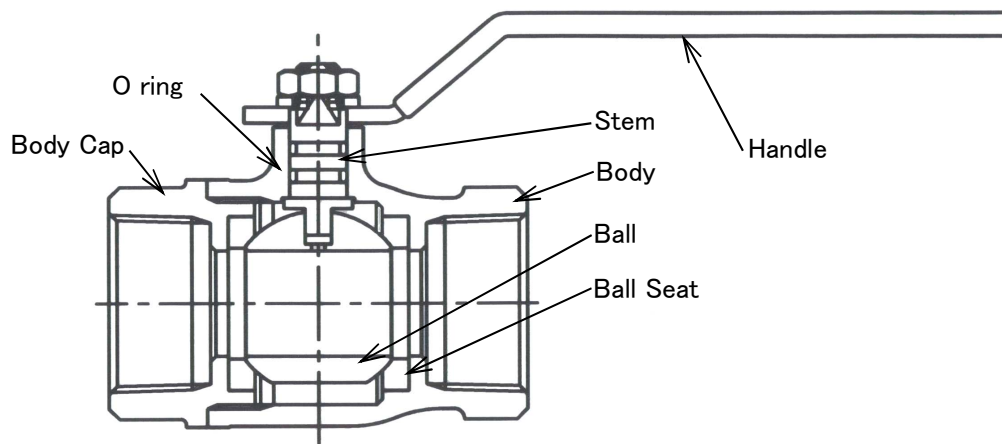

This illustration represents a typical construction.

CHAPTER II

Valve Operation Device

II Valve Operation Device

1. Lever Type Operator

1.1 Levers are mounted directly on the valve stem.

1.2 Rotating the lever clockwise by 90° will close the ball, and moving the lever counterclockwise by 90° opens it.

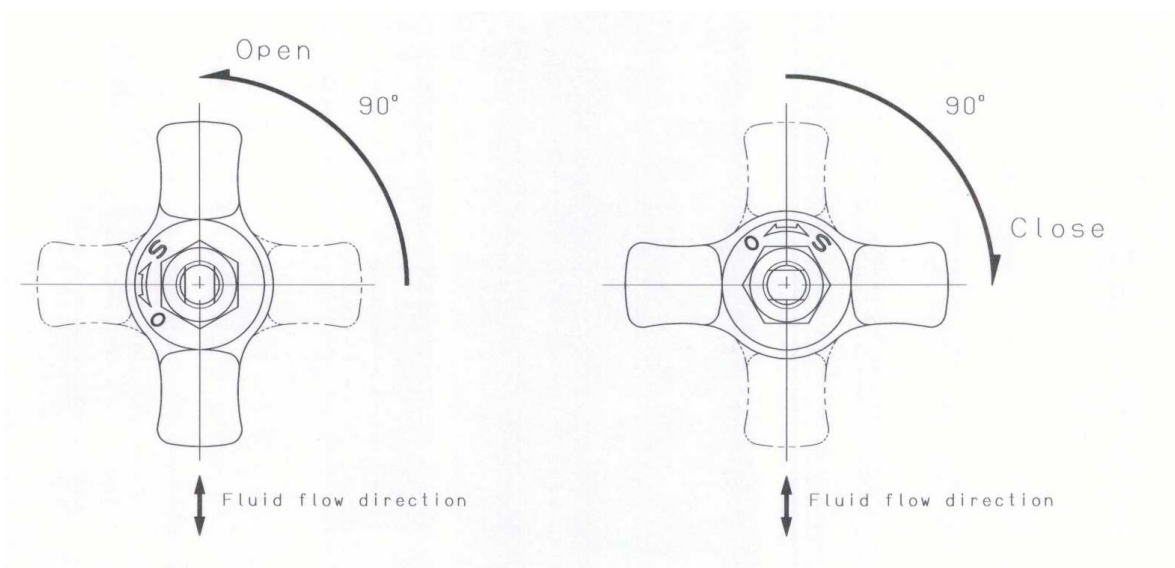
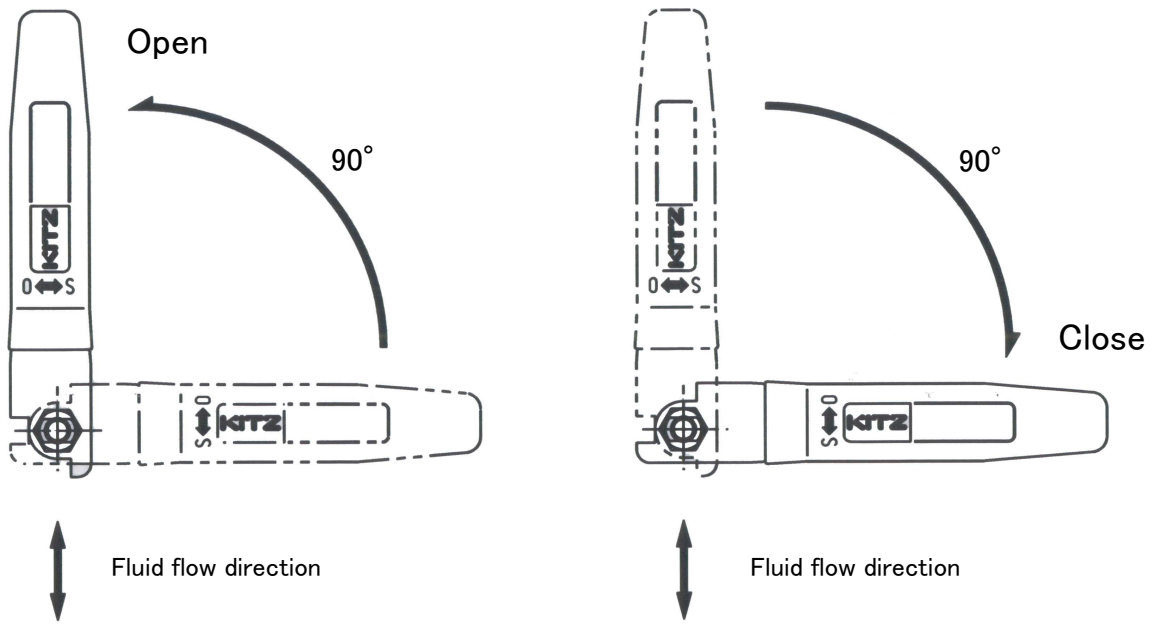



CHAPTER III

Shipping, Handling and Storage of Valves

III Shipping, Handling and Storage of Valves

1. Shipping and Handling Valves

1.1 Care for Shipping and Handling Valves

 CAUTION	
	(1) Take care the handling and storage of carton packed The high humidity may damage the cartons, which may lead to damaging valves.

1.2 Shipping and Handling Valves



1.2.1 Maintain original packing condition during shipment.

1.2.2 Handle valves carefully so that they may not fall or drop on the ground. Any extraordinary mechanical impact should be avoided.

III Shipping, Handling and Storage of Valves

2. Storage

2.1 Care for Valve Storage

 CAUTION	
	<p>(1) DO NOT storage valves in the corrosive environment, which may cause corrosion on threaded portions of valves.</p> <p>(2) DO NOT fall, drop, give mechanical impact or place any other objects on valves, and DO NOT step on them, which may damage valves.</p> <p>(3) DO NOT carelessly pile up products to avoid risk of product damage and personal injury caused by unstable piling.</p>
	<p>(4) Keep the valves in the open position during storage. Storing the valves in halfway position may deform the ball seats, leading to the internal leakage.</p>

2.2 Storage



2.2.1 Indoor storage of valves in a dust-free, low humidity and well ventilated places is recommended.

2.2.2 Storage of valves directly on the ground or concrete floor is not recommended.

CHAPTER IV
Valve Installation

IV Valve Installation

1. Care for choice of location for Valve installation

 CAUTION	
	<ol style="list-style-type: none">(1) Keep a secure footing for valve installation and operation.(2) Sufficient lighting should be prepared for valve operation.(3) Piping should be properly supported, if needed.

- 1.1 Allow sufficient room for operation, installation and subsequent maintenance of valves, considering the valve height and the stem direction.
- 1.2 Take appropriate measures for smooth operation, inspection and maintenance of valves if they are forced to be installed in small spaces.
- 1.3 Try not to install valves in the places where valve functions may be hampered by such outer forces as vibrations.
- 1.4 It is recommended to install valves on horizontal piping in a upright position.

IV Valve Installation

2 Care for Valve inspection

⚠ WARNING	
!	(1) Keep off the valve lifting area to prevent personal injury caused by unsecured valves.

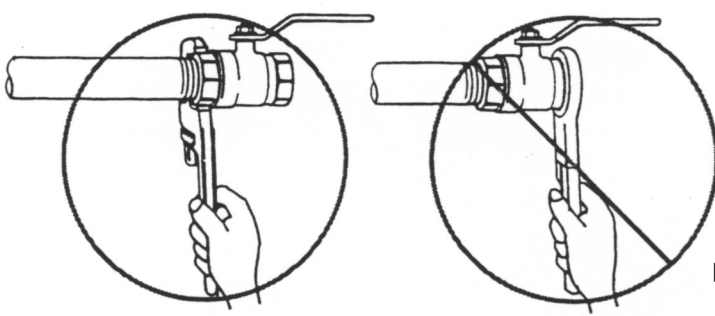
⚠ CAUTION	
⊘	(1) DO NOT disassemble valves during installation.
!	<p>(2) Take care not to damage threaded areas and seat surfaces during installation.</p> <p>(3) Use appropriate sealing materials in threaded areas, considering temperature, types and other conditions of the media.</p> <p>(4) DO NOT use pipe wrenches on valves. Use spanner or other proper tools for valve installation.</p> <p>(5) Apply a spanner to the valve end on the connecting pipe side. DO NOT apply a spanner on the other side.</p> <div style="text-align: center;">  <p style="text-align: right;">Prohibition</p> </div> <p>(6) DO NOT apply any external force counterclockwise around the body-bonnet or body-cap joints of valves, since it would unintentionally loosen the joints.</p> <p>(7) DO NOT overly thread valves into the pipes. Excessive insertion of valves into the pipes may end up damaging the valve seats.</p> <p>(8) Keep valves fully open during valve installation in order to protect the ball surface.</p>

IV Valve Installation

- 2.1 Check the following items before installation for safe operation of valves.
 - 2.1.1 The service conditions should be within the range of the relevant valve specifications.
 - 2.1.2 Valve threads should correspond with pipe threads.
 - 2.1.3 No damage should be found on valve and pipe threads.
 - 2.1.4 Make sure pipe threads comply with the relevant standards by using thread gauges.
- 2.2 Before installation, the inside and threaded areas of the connecting pipes should be cleaned to remove any foreign object such as sand, dust or welding spatters.
- 2.3 Handle valves carefully so that they may not fall or drop on the ground. Any extraordinary mechanical impact should be avoided.
- 2.4 Remove the protection covers just before installation.
- 2.5 Check all threaded areas after installation and retighten them, if needed.
- 2.6 Flush piping after installation with the valves fully opened, to assure removal of any foreign object. DO NOT operate the valves during flushing.

IV Valve Installation

3. Valve installation procedure

3.1 Ensure the connecting areas of pipes to valves are threaded.

3.2 Remove all foreign objects such as cuttings and oil from pipes, inside pipes and threaded connections of valves by using detergents and waste cloth.

3.3 Apply sealing agents, including seal tapes, to the threads of pipes.

3.4 Use appropriate tools to thread pipes into valves.

3.5 Do not apply an excessive torque, when threading pipes into valves. Torques should not exceed the value shown below.

Nominal Size	1/8	1/4	3/8	1/2	3/4	1
Torque N-m	20 – 29	20 – 29	20 – 29	20 – 29	39 – 49	49 – 59

Nominal Size	1-1/4	1-1/2	2	2-1/2	3 and larger
Torque N-m	59 – 69	69 – 78	78 – 88	108 – 118	127 – 137



3.6 Gradually increase the pressure and temperature of pipelines, when conducting test run. Retighten all threaded areas of valves, if needed.

CHAPTER V

Valve Operation

V Valve Operation

1. Cautions for Safety

 CAUTION	
	<p>(1) DO NOT apply too excessive force to operate the valves by such methods as using a pipe or any other device.</p> <p>(2) Never loosen the gland, cap flanges and end threads of pressurized valves.</p> <p>(3) DO NOT use valves in an intermediate position. Such use may damage ball seats and cause internal through-bore leakage.</p>
	<p>(4) For valves with the gland packing design, retighten the gland bolts and nuts before operation of valves. Check a handle torque while retightening the bolts and nuts so that the operation won't become too difficult due to over-tightening. Gland bolts should be alternately tightened with an even force.</p> <p>(5) Valve should be kept fully open during the line test or pressure test. Fully closing valves during the test may deform the ball seats, leading to the occurrence of internal through-bore leakage.</p> <p>(6) Gradually open valves to prevent damage of pipes, when high temperature fluids such as steam are handled.</p> <p>(7) Take some appropriate measures to prevent freezing, as needed.</p>

2. Operation

2.1 Lever handle

Rotation of the valve stem by 90° fully opens or closes the valve. To close the valve, turn the operating handle clockwise according to the letters and the mark indicating the direction. Counterclockwise rotation will open the valve.

V Valve Operation

3. Daily Inspection



In order to operate your valves safely and satisfactorily, the daily inspection is very important. Here are the inspection items.

Inspection items	Areas to be inspected	Inspection Method	Remedial Measure
External Leakage	Gland Area	Visual Check with soap solution	Retighten gland. (Only for valves with the gland packing design)
	Threaded Portions	Visual Check with soap solution	Retighten each threaded areas.
	Body	Visual Check with soap solution	Replace the valve.
Abnormal Noises	Valve body	Auditory check	Consult a piping engineer.
	Loosened bolting	Auditory check	Retighten bolting.
	Pipe vibration	Auditory check	Consult a piping engineer
Loosened Bolting	Bolts and Nuts	Visual and Tactile check	Retighten bolts and nuts.
Internal thru-bore leakage	—	—	Remove foreign object. Replace the valve.
Valve operation	Valve operating position	Visual Check	Make sure that the valve is in predetermined position.
	Disturbed operation	Visual and Tactile check	Disassemble and inspect the valve components. Replace the valve.

(NOTE) Don't reuse the valve that is not using gasket between body and body cap.
In this case, change the valve to the new one.

V Valve Operation

4. Trouble Shooting and Corrective Measures

 CAUTION	
	<p>(1) Wear the protective items such as goggles, gloves, working boots.</p> <p>(2) For valves with the gland packing design, ensure to reduce the line pressure to the atmospheric level, before retightening the packing rings</p>

4.1 Leakage from the gland area (For valves with the gland packing design)

Retighten the gland, if leakage from this area is detected. Adequate torque should be applied when retightening the gland so that the valve operation won't become difficult.

5. Trouble Shooting

Defect	Possible causes	Remedial measure
Disturbed valve operation	Foreign objects may have choked up the valve body cavity and stock around the ball seats.	Disassemble and inspect the valve components. Replace the valve.
Excessive valve torque	Foreign objects may have stuck to the stem.	Remove the foreign objects and check the valve.
	Foreign objects may have choked up the valve body cavity and stock around the ball seats.	Flush the built-up objects by the media with the ball slightly open and disassemble and inspect the valve.
Leakage from The gland area	Loose gland packing.	Retighten the gland packing.
	Damage on the O-ring and gland packing.	Replace the valve.
Internal through-bore leakage	Damage on the ball seats.	Disassemble and inspect the valve. Replace the valve.
Abnormal noise or vibration	Loose bolts and nuts..	Retighten the bolts and nuts.

(NOTE) Don't reuse the valve that is not using gasket between body and body cap.

In this case, change the valve to the new one.

CHAPTER VI

Periodic Inspection and Maintenance of Valves

VI Periodic Inspection and Maintenance of Valves

1. Periodic Inspection



- 1.1 A periodic inspection with valves mounted to pipelines is recommended at least once a year.
- 1.2 Ensure the smooth operation and safety of valves before inspection.
- 1.3 Inspection items and methods are same as daily inspection. See Chapter V for the items and methods suggested.
- 1.4 Where valves and adjoining piping are not daily inspected or not operated for a long period of time, a periodic inspection is also recommended. (A periodic inspection should be carried out on all valves.)



VI Periodic Inspection and Maintenance of Valves

2. Inspection and maintenance

In case pipelines or facilities where valves are installed are shut down for the pipeline inspection, remove the valves from the pipelines and perform the body and seat pressure tests as well as operation tests, if needed. If any defect is found, disassemble the valves for further inspection. The valves must pass required inspections before being sent back to the pipelines or facilities for reinstallation.

2.1 Cautions for removal of the valves from pipelines or installation of the valves on pipelines.

 WARNING	
	<ul style="list-style-type: none"> (1) Discharge the fluid from the pipes and reduce the line pressure to the atmospheric level when disassembling valves. (2) Discharge the fluid and pressure trapped within the valve body with the valve intermediate position before disassembling. (3) In case fluid is toxic, inflammable or corrosive, remove the fluid completely from pipes and internal valves. (4) Take protective measures to prevent direct exposure to the fluid and catching fire. (5) Keep off the working area to prevent personal injury if valves are installed at higher places.

 CAUTION	
	<ul style="list-style-type: none"> (1) Wear the protective items such as goggle, gloves and working boots. (2) Keep a secure footing for valve dismantle and installation. (3) Apply a spanner to the valve end on the connecting pipe side, when the valves are removed from or installed to pipes.

VI Periodic Inspection and Maintenance of Valves

2.2 Assembly and disassembly

Refer to Chapter VII for assembly and disassembly procedure.

2.3 Test and Inspection



Refer to the following procedure for test and inspection.

2.3.1 Operation Test

- (1) Check smooth operation of valves without galling or sticking of internal valve components.
- (2) Check that the stem is firmly assembled with the ball.
- (3) Ensure that there should be no offset of the ball port and ball seats in the fully open position. The ball should not be protruded into the valve port other than the rounded surface of the ball port edges.

2.3.2 Shell Test and Seat Leakage Test

- (1) Care for shell test and seat leakage test

 CAUTION	
	<ol style="list-style-type: none">(1) Wear the protective items such as goggles, gloves and working boots.(2) Before shell test and seat leakage test begin, take some precautions for operators safety.

- (2) Shell Test and Seat Leakage Test

All valves should be subjected to a hydrostatic or pneumatic shell test and seat leakage test at the required test pressures after reassembly.

Refer to JIS B2003 for test methods and procedures.



CHAPTER VII





Disassembly and Reassembly of Valves

VII Disassembly and Reassembly of Valves

1. Disassembly procedure

1.1 Care for disassembly

 WARNING	
	(1) Operator should take an appropriate caution for not being exposed to the fluid or catching fire.

 CAUTION	
	(1) Don't reuse the valve that is not using gasket between body and body cap. In this case, change the valve to the new one.
	(2) Wear the protective items such as goggle, gloves and working boots.
	(3) Pay attention not to catch fingers during disassembly.

1.2 Before Disassembly

1.2.1 Place the valve in a dust-free place.

1.2.2 Take care not to damage the ball, stem and other parts.

1.3 Disassembly procedure

1.3.1 Full close the valve.

1.3.2 Disassemble the body(1) and body cap(2).

1.3.3 Remove the gasket(19) from the body(1).

1.3.4 Remove the ball(4) from the body(1).

1.3.5 Remove the ball seats(30) from the body(1) and body cap(2).

1.3.6 Remove the handle nut(10), spring washer(16) and lever(9) from the stem(3).

1.3.7 Remove the nut(34), coned disc spring(43) and gland(7) from the stem(3).

1.3.8 Push the stem(3) down into the body cavity to remove it from inside the body(1).



1.3.9 Remove the packing(8) from the body(1).

1.3.10 Remove the thrust washer(47) from the stem(3) or body(1).

VII Disassembly and Reassembly of Valves

2. Reassembly procedure

2.1 Care for reassembly

 CAUTION	
	(1) Don't reuse the valve that is not using gasket between body and body cap. In this case, change the valve to the new one.
	(2) Wear the protective items such as goggle, gloves and working boots. (3) No open flame or smoking should be allowed in the working area. (4) Take care not to catch fingers in flanges during assembly.

2.2 Before Assembly

2.2.1 Check all parts before assembly. If any problem is detected, replace the valve.

2.2.2 Clean all parts for reuse to thoroughly remove dust and other foreign objects.

2.2.3 Assemble the valve in a dust-free area.

2.2.4 Take care not to damage all parts especially the ball, ball seats and stem.

2.2.5 Keep in mind that all threads should be securely tightened.

VII Disassembly and Reassembly of Valves

2.3 Reassembly procedure

- 2.3.1 Mount the ball seats in the body (1) and body cap (2).
- 2.3.2 Mount the thrust washer(47) on the stem(3).
- 2.3.3 Assemble the stem(3) into the body(1) from the body interior. Ensure that the stem collar securely contacts the body.
- 2.3.4 Assemble the packing(8), gland(7), and coned disc spring(43), to the body then tighten the nut(34).
- 2.3.5 Assemble the lever(9) and spring washer (16) to the stem(3), then tighten the handle nut(10) and that the valve position is fully closed.
- 2.3.6 Place the ball (4) into the body (1).
- 2.3.7 Assemble the gasket(19) on the body(1) or body cap(2).
- 2.3.8 Securely screw the body cap(2) into the body(1). Ensure that the ball seats(30) are placed in the correct position.

VII Disassembly and Reassembly of Valves

3. Cross-sectional assembly drawing.

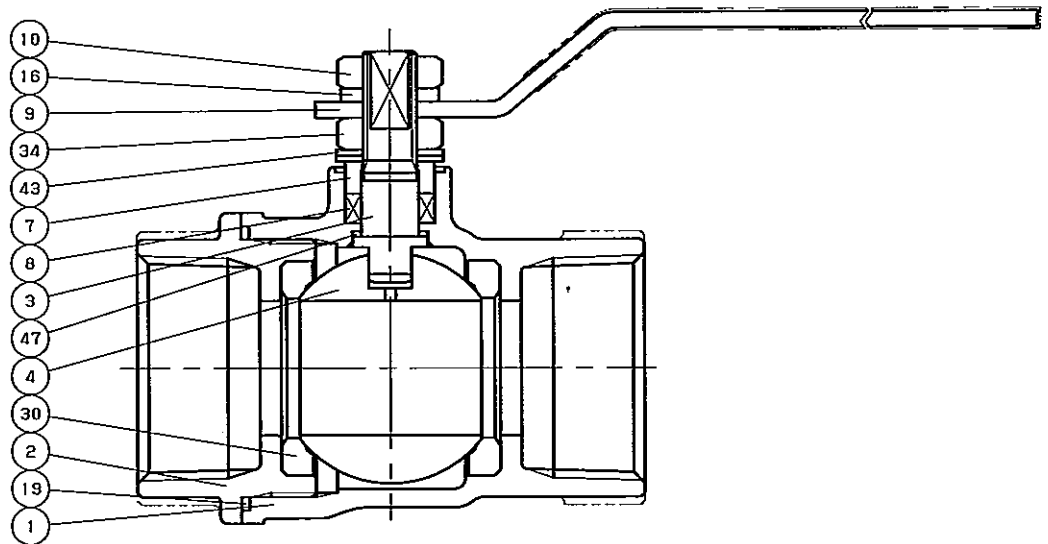

No.	Parts Name
1	Body
2	Body Cap
3	Stem
4	Ball
7	Gland
8	Packing
9	Lever
10	Handle nut
16	Spring Washer
19	Gasket
30	Ball Seat
34	Nut
43	Coned disc spring
47	Thrust Washer

This drawing introduces a typical construction of the valve.
Refer to the approval drawing before disassembly and assembly.