KITZ

Operation Manual

For

KITZ Wafer Type Check Valves

Thank you for choosing KITZ products.

For safe and trouble-free function and performance of the product, make sure to read and understand all items in this manual before valve mounting and operation.

Keep this manual accessible to all valve operating personnel.

This manual applies to KITZ wafer type check valves.

SAFETY PRECAUTIONS

For the safe use of the product, read all safety precautions in this manual before handling the product.

The safety precautions in this manual are determined to ensure safe and proper use of the product and to prevent personal injury and property damage. This manual uses two terms, "Warning" and "Caution", according to the hazard level, to clearly indicate the extent and severity of the risk.

Both "Warning" and "Caution" indicate important safety instructions. Please be sure to follow them.



WARNING

Indicates an imminently hazardous situation that, if not avoided, may result in serious injury or death.



CAUTION

Indicates a potentially hazardous situation that, if not avoided, may result in minor or moderate injury and product damage.

The following signs represent explanations and instructions to be followed:



Indicates a "prohibited" action that must not be carried out.



Indicates a "mandatory" action that must be carried out.

NOTES TO USERS

- This manual is designed to show an appropriate usage of the products for transportation, storage, installation, operation and maintenance. Be sure to read through this manual before handling the products.
- This manual does not cover the whole scope of conceivable usage of the products for transportation, storage, installation, operation and maintenance. If technical assistance beyond the scope of this manual is required, contact KITZ Corporation or its distributors.
- The specifications have been determined with safety consideration. Do not use the products beyond the specifications.
- The illustrations given in this manual do not show all the details. If more detailed information is required, refer to the relevant valve assembly drawings.

*Any information provided in this operation manual is subject to change without prior notice.

Contents

I. Construction and Design Features	1
II. Valve Operating Device	6
III. Transportation and Storage	8
IV. Valve Installation	11
V. Valve Operation	16
VI. Periodic Inspection	21
VII. Disassembly and Assembly	25

I. Construction and Design Features

I. Construction and Design Features

1. Construction and Function

- 1.1 Construction and parts names are as indicated in the figure below.
- 1.2 The disc is turned on a pivot of the pin by the force of velocity pressure and closed by the force of helical spring and gravity.
- 1.3 Only unidirectional flow is applied to prevent reverse flow.
- 1.4 The flow direction is indicated on the body.
- 1.5 The built-in by-pass valve can be used to eject the fluid in the piping to the upstream side by opening the by-pass valve when the check valve is closed to prevent backflow.

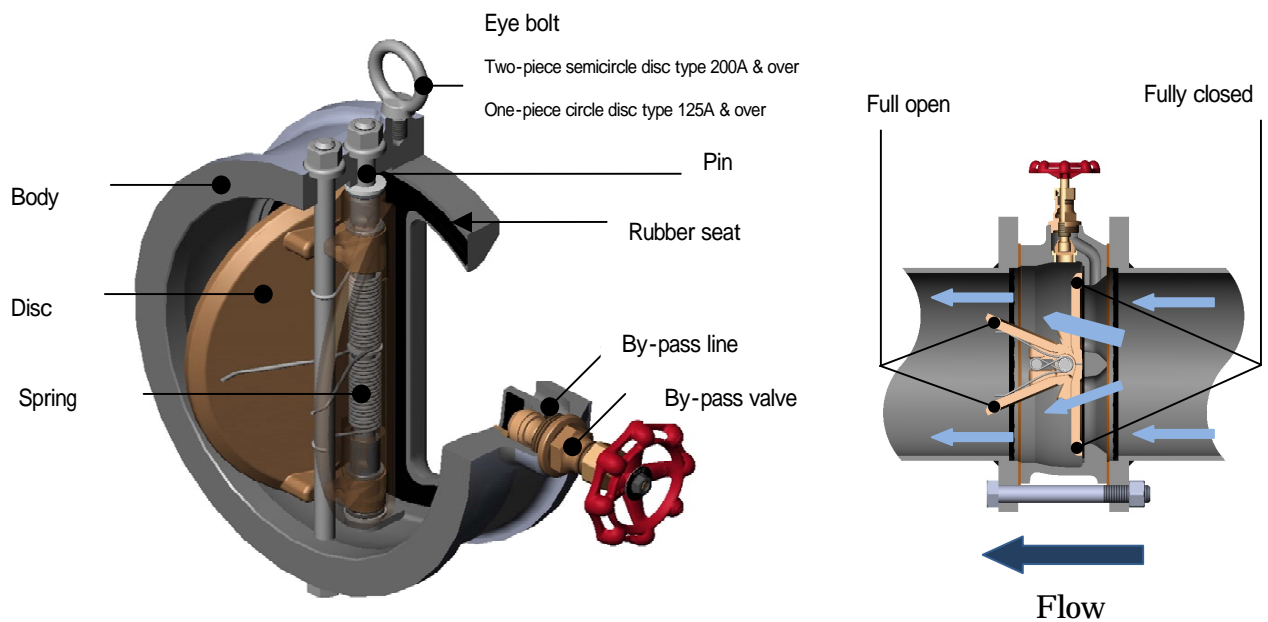

This illustration shows a typical construction.

I. Construction and Design Features

2. Design Features

2.1 Reduction of water hammer

Reduces the occurrence of water hammer by closing the disc with the independent helical spring mechanism and protects the piping device such as pumps.

2.2 Built-in by-pass valve

Integrated with a by-pass valve for the rationalization of the piping design and work.

2.3 Excellent sealing performance

Provides superior sealing performance by means of rubber seats and spring mechanism when compared with the existing check valves.

2.4 Direct mounting of pump

Optimization of the disc opening degree and modification of the pin insertion section on the disc and the pin fixing method allow direct mounting of a pump.

Direct mounting of a pump is not available for the product made of stainless steel because of the structural difference.

Provide straight runs of pipe at least twice the length of the valve bore (three times in the case when a pipe expansion is used to the pump discharge) to the both sides of the valve.

2.5 Compact and light mass.

Saves space for valve mounting and piping, and makes the installation easy.

I. Construction and Design Features

3. Valve Specifications

3.1 Service fluid

Water, Air, Oil (lubricating oil, hydraulic oil, etc.)

3.2 Maximum working pressure and temperature

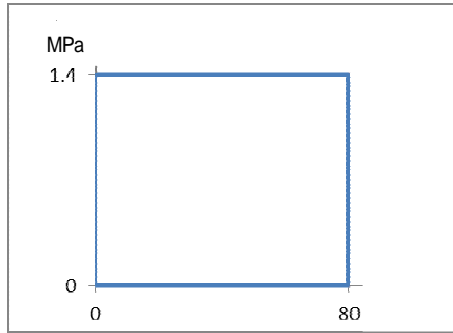

10BWZ, 10BWZN, 10FWZ, 10SWZU, 10UW

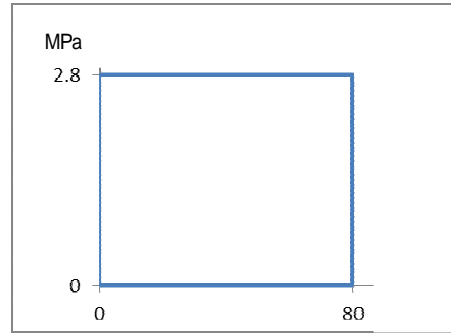

20SWZ, 20SWZU

Maximum working pressure for (F)20SWZ approved by the Fire Service Act: 2.0MPa

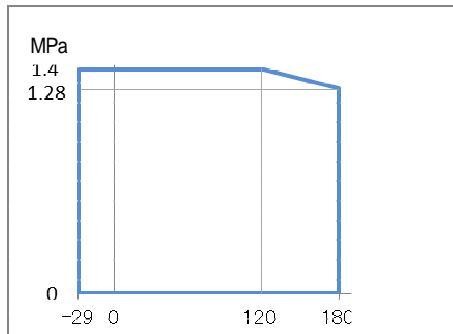

10 UWS

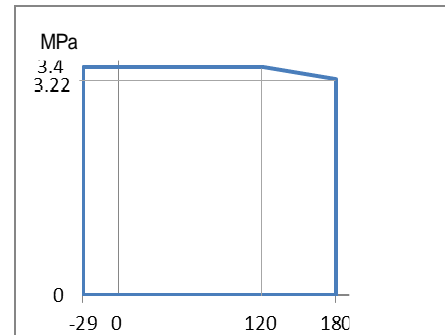

20 UWS

3.3 Serviceable range

Fluid	Size	Velocity	Spring
Gas	All sizes	-	Low torque
Liquid (Horizontal piping and vertical, upward flow piping with less than 80 meters of pump head)	100 A and below	Min. 0.5m/s Less than 1.0 m/s	Low torque
		Min. 1.0 m/s Max.4.0 m/s	Standard torque
	125 A and over	Min.1.0m/s Less than 1.5 m/s	Low torque
		Min. 1.5 m/s Max. 4.0 m/s	Standard torque
Liquid (Piping with 80 meters or over of pump head)	All sizes	Min. 1.0 m/s Max. 4.0 m/s	High torque

I. Construction and Design Features

4. Piping Bolt Dimension and Number

Bolts and nuts for piping are provided to the valve. Refer to the table below for the bolt dimensions and the numbers. The bolt lengths are calculated for use of steel flanges and 3-millimeter-thick gaskets.

n: number of bolt

Nominal Size		10 K Type												20 K Type						
A	B	10BWZ/10BWZN				10FWZ/10SWZU				10UW/10UWS				20SWZ/20SWZU				20UWS		
		M	n	L	S	M	n	L	S	M	n	L	S	M	n	L				
40	1.1/2	M16	4	115	38	M16	4	115	38	-	-	-	-	M16	4	115	38	-	-	-
50	2	M16	4	115	38	M16	4	115	38	M16	4	115	38	M16	8	120	38	M16	8	140
65	2.1/2	M16	4	120	38	M16	4	120	38	M16	4	125	38	M16	8	130	44	M16	8	150
80	3	M16	8	120	38	M16	8	120	38	M16	8	130	44	M20	8	150	52	M20	8	170
100	4	M16	8	130	44	M16	8	130	44	M16	8	130	44	M20	8	150	52	M20	8	175
125	5	M20	8	140	52	M20	8	140	52	M20	8	160	52	M22	8	170	56	M22	8	195
150	6	M20	8	150	52	M20	8	150	52	M20	8	170	52	M22	12	190	56	M22	12	210
200	8	M20	12	170	52	M20	12	170	52	M20	12	200	52	M22	12	240	-	M22	12	245
250	10	M22	12	220	-	M22	12	220	-	M22	12	230	52	M24	12	270	-	M24	12	275
300	12	M22	16	260	-	M22	16	260	-	M22	14	260	69	M24	16	320	-	M24	14	315
350	14	-	-	-	-	M22	16	300	-	-	-	-	-	M30	16	335	-	-	-	-
400	16	-	-	-	-	M24	16	320	-	-	-	-	-	M30	16	360	-	-	-	-
450	18	-	-	-	-	M24	20	330	-	-	-	-	-	M30	20	380	-	-	-	-

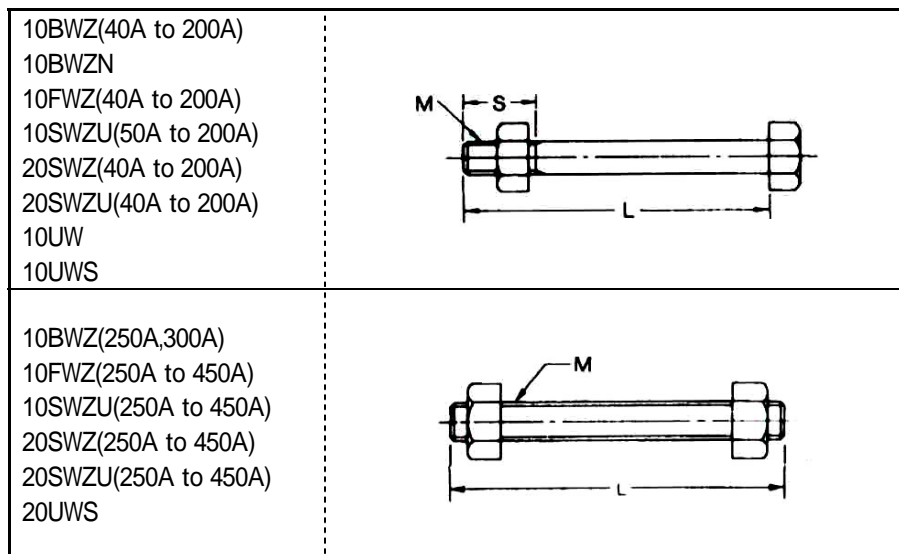

II. Valve Operating Device

II. Valve Operating Device

Handwheel of by-pass valve

1. The handwheel is directly mounted on the by-pass valve stem.
2. According to the arrow and word on the handwheel, turn the handwheel clockwise to close the by-pass valve, and turn the handwheel counterclockwise to open the by-pass valve.
3. The operating force of the handwheel depends on the opening position of the valve and the valve type.

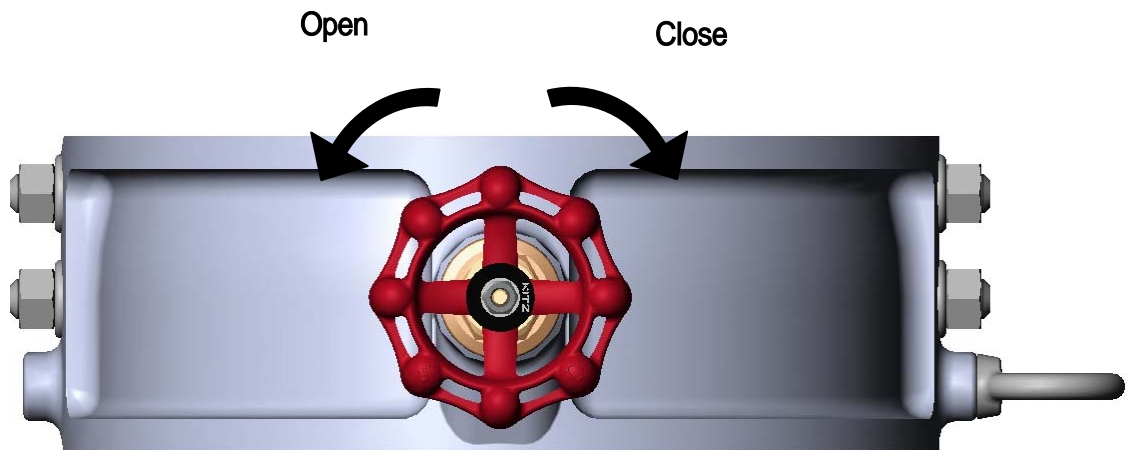



III. Transportation and Storage

III. Transportation and Storage

1. Transportation

1.1 Precautions for safety

 CAUTION	
	<ul style="list-style-type: none">(1) Take care not to damage the painting surface of the valve during transportation, which may subsequently cause corrosion and get the valve rusty. And damaged surface should be adequately touched up before installation.(2) Take care in handling and storage of carton packed products. High humidity may damage the cartons.

1.2 Transportation



1.2.1 Keep the product in its original packaging condition until installation.

1.2.2 Handle the valve carefully so that it may not fall or drop on the ground. Any extraordinary mechanical impact should be avoided.

III. Transportation and Storage

2. Storage

2.1 Precautions for safety

 CAUTION	
	<ul style="list-style-type: none">(1) Do not store valves in the corrosive environment, which may cause corrosion on the threaded portions of the valve.(2) Do not place any objects on the valve, and do not step on the valve. Overloading may damage the valve.(3) Do not carelessly pile up products. Risk of product damage and personal injury caused by unstable piling should be avoided.









2.2 Storage

- 2.2.1 Store the valve at a dust-free, least humid and well-ventilated place. Indoor storage is recommended.
- 2.2.2 Storage of the valve directly on the ground or concrete floor is not recommended. Packed valves should be placed on the rack for storage.
- 2.2.3 Take appropriate measures to prevent the valve from direct exposure to dust, rain and sunlight if it is stored outdoors by necessity.

IV. Valve Installation

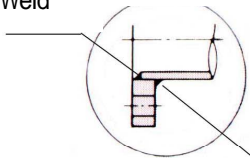
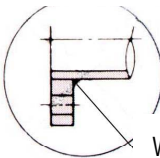
IV. Valve Installation

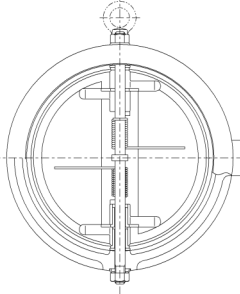
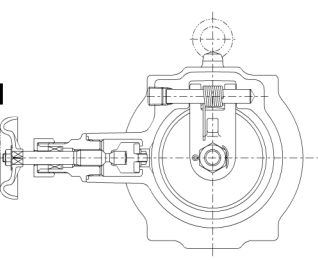
1. Precautions for Safety







 WARNING	
	(1) Check the valve specifications with catalogs before installation. Service beyond the valve specifications may cause fluid leakage and valve malfunctions.
	(2) Do not apply the following corrosive fluid to cast iron valves and ductile iron valves (product code: 10FWZ, 20SWZ) because they incorporate the copper by-pass valve. (The strong alkalinity fluids such as Acetylene, Ammonia, Di-methylamine, Ethyl Amine, Butadiene, Ethylene Oxide, Sulfur, and Caustic soda).
 CAUTION	
	(1) Keep a secure footing for valve installation and operation. (2) Ensure sufficient lighting for valve operation. (3) Piping should be properly supported, if needed. (4) Weld and connect the pipe and the flange as shown below.
	<div style="display: flex; justify-content: space-around;"> <div style="text-align: center;"> <p>Correct</p>  <p>Weld</p> </div> <div style="text-align: center;"> <p>Incorrect</p>  <p>Weld</p> </div> </div>
	(5) A part of the disc sticks out from the body end in the open position. Make sure that the disc does not contact the pipe end or the gasket when piping. (6) Install the stem of the by-pass valve horizontally if the main valve is installed in a horizontal piping. The pin should come in the upper side for the one-piece circle disc type. Refer to the figure below.
	<div style="display: flex; justify-content: space-around; align-items: center;"> <div style="text-align: center;">  <p>Two-piece semicircle disc type</p> </div> <div style="text-align: center;"> <p>Horizontal</p>  <p>One-piece circle disc type</p> </div> </div>
	(7) Do not connect directly to the valves, such as butterfly valves, whose disc sticks out from the body end.

IV. Valve Installation

- 1.1 Allow sufficient space for operation, installation and subsequent maintenance of valves.
- 1.2 For smooth operation, inspection and maintenance, take appropriate measures for the valve installed in a confined area by necessity.
- 1.3 Try not to install the valve in the place where valve functions may be hampered by such outer forces as vibrations and others.

IV. Valve Installation

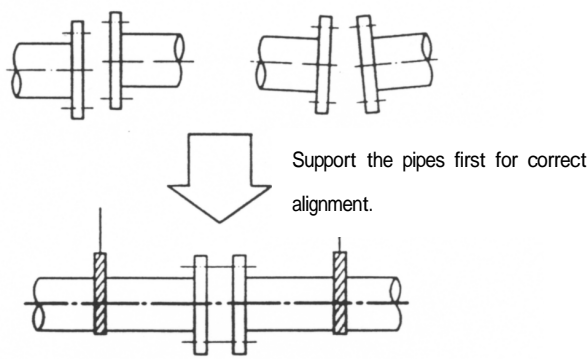
2. Precautions for Safety

 <b style="font-size: 1.2em;">WARNING	
	<p>(1) Keep off the valve lifting area to prevent personal injury caused by unsecured valves.</p>
 <b style="font-size: 1.2em;">CAUTION	
	<p>(1) Pay attention not to catch your fingers during mounting work.</p> <p>(2) Make sure to install the welded flange after being cooled down to the ambient temperature.</p> <p>(3) Edges of the welded part of flange should be ground off to prevent damage of the valve.</p> <p>(4) Pipes should be properly supported as required.</p> <p>(5) Before mounting the valve, remove foreign objects such as sand, dust and welding spatters from the connecting pipe interior.</p> <p>(6) The wafer type check valve should be mounted in accordance with arrows indicated on the valve body.</p> <p>(7) Packing tightening stress may have been lowered due to the stress relaxation during transportation and storage, leading to leakage from the gland area. Retighten the packing nut before operation.</p> <p>(8) Connection flanges must be free from any damage or deformation. Please remove any foreign objects or rust from the flange surface.</p> <p>(9) Align the upstream side piping with the downstream side piping accurately. The leakage from the flange connection will be caused by inaccurate alignment.</p> <div style="text-align: center; margin: 10px 0;">  </div> <p>(10) When the valve is hanged with a chain block or other appropriate tool, use the eye bolt provided on the body of 10 UW, 10UWS and 20 UWS in nominal size 125A and over, and of other types in 200 A and over.</p> <p>(11) Tapping threads for the eye bolt are provided on the upper side and lower side of the body. Attach the eye bolt to the opposite side when valve lifting is required to change the direction of the by-pass valve against the fluid flow.</p> <p>(12) Vertical piping is available for wafer type check valves, but it is limited to the piping which has an upward flow direction.</p> <p>(13) Use new gaskets when installing the valve to the pipeline. The gasket with inside diameter a little larger than the valve inside diameter will be recommended.</p>
	<p>(14) Do not hook up the handwheel of the by-pass valve. Do not step on the by-pass valve during piping.</p>

IV. Valve Installation

3. Mounting Procedures

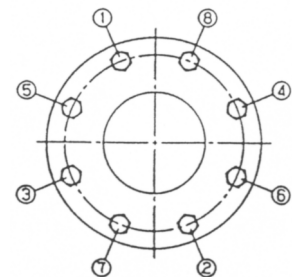
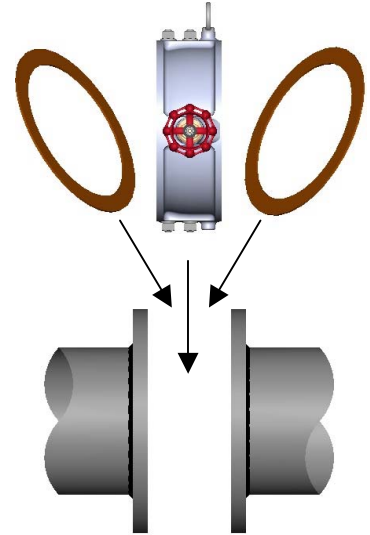

- 3.1 For valve mounting, use jack up bolts to keep clearance between the pipe flanges as required. The clearance between the pipe flanges should be 6 to 10 mm wider than the clearance of the face-to-face dimensions of the valves.
- 3.2 First, set the two (2) bolts into the lower side of the pipe flanges without tightening and then install the valve between the flanges carefully. Install the gaskets to both sides and set the two (2) bolts into the upper side of the pipe flanges.
- 3.3 Tighten four (4) of the upper and bottom bolts temporarily. Align the pipes and the valve accurately.
- 3.4 Tighten all other bolts through the holes of pipe flanges.
- 3.5 Tighten the bolts evenly, gradually and alternately in a star pattern as shown below. The end of all tightened bolts should equally protrude beyond the nuts.
- 3.6 Gradually raise the line temperature and pressure for the test operation. Retighten each threaded portion if needed.



V. Valve Operation

V. Valve Operation

1. Precautions for Safety

 CAUTION	
	<ul style="list-style-type: none">(1) Do not apply excessive torque to the by-pass valve.(2) Do not loosen the packing nut and bonnet while fluid is pressurized.
	<ul style="list-style-type: none">(3) Keep the by-pass valve in the fully closed position when the by-pass line is not used.(4) Retighten the packing nut before using the valve. Over-tightening the packing nut may cause non-smooth operation.(5) Take appropriate measures against freezing of the pipes and valves.

2. By-pass Valve Operation

Turn the handwheel clockwise according to the symbols or marks indicating the direction to close the valve. Turn the hand wheel counterclockwise to open the valve.

V. Valve Operation



3. Daily Inspection

In order to operate the valve safely and satisfactorily, a daily inspection should be performed. The inspection items are as shown below.

Inspection item	Areas for inspection	Inspection method	Remedial measures
External leakage	Gland area	Visual check Soap water	Retighten the packing nut Replace the gland packing
	Flange area	Visual check Soap water	Retighten the flange bolts. Replace the gaskets.
	Each threaded portion	Visual check Soap water	Retighten each threaded portion. Replace related components.
	Body surface	Visual check Soap water	Replace the valve.
Abnormal noise	Valve body	Auditory check	Consult the piping engineer
	Each threaded portion	Auditory check Tactile check	Retighten each threaded portion.
	Pipe vibration	Auditory check	Consult the piping engineer
Loosened threaded portion	Each threaded portion	Visual check Tactile check	Retighten each threaded portion.
Seat leakage	-	-	Remove foreign objects. Disassemble and inspect the valve components. Replace the valve.
Non-smooth valve operation	Opening-Closing position (By-pass valve)	Visual check	Make sure that the valve is in the predetermined position.
	Handwheel	Tactile check Auditory check	Disassemble and inspect the valve components. Replace the valve.

V. Valve Operation

4. Remedial Measures

 CAUTION	
	<ol style="list-style-type: none"> (1) Wear protective items such as goggles, gloves and working boots. (2) Take safety measures against toxic, flammable and corrosive fluids. (3) Reduce the line pressure to the atmospheric level before retightening the packing nut, flange bolts and nuts. (4) Operators should take protective measures to prevent direct exposure to the fluid in case the fluid spouts out from the flange areas. (5) Reduce the line pressure to the atmospheric level when packing and gaskets are replaced, or bolts and nuts are loosened. Operators should take protective measures to prevent direct exposure to the fluid in case the fluid spouts out from the valve.

4.1 Leakage from gland area

Adequately retighten the packing nut if the leakage is found from the gland area. If retightening the packing nut cannot solve the leakage, the gland packing should be replaced with a new one.



4.2 Leakage from flange area

Tighten the flange bolts evenly, gradually and alternately in the star pattern as shown.

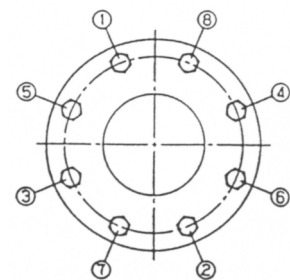

4.3 Check abnormal noise

Conceivable causes of abnormal noises are as follows:

- The disc in the fully opened position hits the stopper pin due to fluid turbulence.
- The disc in the fully closed position hits the body due to low velocity in the pipe. (Known as chattering)
- The disc in the fully closed position hits the body due to water hammer.

When an abnormal sound is heard, disassemble and check the components such as the disc pin or spring. Abrasion of the sliding parts of the pin and the disc or damage of the spring may occur when the wafer type check valve is used under an abnormal noise condition. Piping should be reconsidered to solve the problems.

V. Valve Operation

5. Troubleshooting

Trouble	Possible cause	Measures
Unable to operate the by-pass valve	Foreign objects stick to the seat.	Partly open the by-pass valve and flush out the foreign objects with the flow of fluid.
Excessive operation torque of the by-pass valve	Foreign objects stick to the stem	Remove the foreign objects and check the valve.
	Foreign objects are piled up at the valve body bottom.	Partly open the by-pass valve and flush out the foreign objects with the flow of fluid.
	The packing nuts are over-tightened.	Loosen the packing nut and retighten it properly.
Leakage from the gland area	The packing nuts are loosely tightened.	Retighten the packing nut.
	The gland packing is damaged.	Replace the gland packing.
Leakage from the gasket	Flange bolts and nuts are loosened.	Retighten the flange bolts and nuts.
	Flange bolts and nuts are unevenly tightened.	Retighten the flange bolts and nuts evenly and gradually.
	The gasket is damaged.	Replace the gasket.
Leakage from the valve seat area in the fully closed position.	The valve seats are damaged.	Disassemble and check the valve.
	The valve seats are deformed by external stress.	Consult the piping engineer.
Occurrence of abnormal noise and vibration	Bolts and nuts are loosened.	Retighten the bolts and nuts.

VI. Periodic Inspection

VI. Periodic Inspection

1. Periodic Inspection



- 1.1 Annually conduct a periodic inspection on the valve with the valve installed.
- 1.2 Check that the valve operates smoothly without any problems for safe use.
- 1.3 See “Chapter V, 3. Daily Inspection” for inspection items and inspection methods.
- 1.4 Conduct a periodic inspection on the valve not being operated for a long period of time or not being inspected daily. (All valves should be inspected.)
- 1.5 It is recommended to replace the gland packing at the time of the periodic inspection.



VI. Periodic Inspection

2. Maintenance Inspection

When piping facilities where the valve is installed are to be opened for maintenance and inspection, carry out leakage and operation tests. No internal seat leakage or external leakage should be acceptable. The valve should operate smoothly without galling or sticking. If any of the above-mentioned problems are found, disassemble the valve and check the valve components. After reassembling the valve, leakage and operation tests should be carried out and the results should be satisfactory.

2.1 Precautions for safety

 WARNING	
	<ol style="list-style-type: none"> (1) Discharge the fluid from the pipes and reduce the line pressure to the atmospheric level. Trapped pressure or fluid is very dangerous and will cause accidents resulting in personal injury. (2) Operators must take protective measures against spouting fluid. No fire should be allowed in the working area. (3) Keep off the valve lifting area to prevent personal injury caused by unsecured valves.

 CAUTION	
	<ol style="list-style-type: none"> (1) Wear protective items such as goggles, gloves and working boots. (2) Keep a secure footing for valve dismantling and installation. (3) In order to prevent misalignment of pipes while a valve is removed and reinstalled, the valve and the pipes should be properly supported. (4) Before dismantling the valve from the piping, mark the original position of the valve body and the corresponding pipe flanges. Reinstall the valve on the piping by matching the marks made earlier. (5) Be sure to insert new gaskets between the valve and flanges when installing the valve on the piping.

VI. Periodic Inspection

2.2 Disassembly and assembly

Disassemble and assemble the valve according to the instructions in “Chapter VII, Disassembly and Assembly “of this manual.

2.3 Test and inspection

The followings are the main items required for valve tests and inspections.

2.3.1 Operation test

(1) By-pass valve



- (a) The valve is operated smoothly without galling or sticking of the moving parts.
- (b) The stem is firmly connected to the disc.
- (c) Offset of the disc and the seat is not acceptable. The disc should be seated on the body seat securely when the valve is fully closed.

(2) Check valve

The disc must move smoothly. When the valve is fully opened, the disc should be stopped against the stopper.

2.3.2 Shell test and seat leakage test

(1) Precautions for safety

 CAUTION	
	<ul style="list-style-type: none"> (1) Wear protective items such as goggles, gloves and working boots. (2) Take sufficient precautions for safety before shell pressure test and seat leakage test.

(2) Shell test and seat leakage test



After reassembly, all valves are subject to hydrostatic or pneumatic shell test and seat leakage test at the required test pressure. Refer to JIS B 2003 or other standards for testing conditions.



VII. Disassembly and Assembly

VII. Disassembly and Assembly

1. Disassembly Procedures

1.1 Precautions for safety

 WARNING	
	(1) Take protective measures against spouting fluid and fire hazards.

 CAUTION	
	(1) Wear protective items such as goggles, gloves and working boots. (2) Pay attention not to catch your fingers during disassembly. (3) Use appropriate equipment to lift a heavy valve.

1.2 Notes for disassembly

1.2.1 Disassemble the valve in a dust-free area.

1.2.2 Care should be taken not to damage the body seat, the disc seat or the gasket sealing faces.

VII. Disassembly and Assembly

1.3 Disassembly procedures for two-piece semicircle disc type (Nominal size 125A and below)

- 1.3.1 Remove the plugs (85) from the body (1).
- 1.3.2 Remove the spacers (80) from the holes where the plugs are removed.
- 1.3.3 Remove the stop pin (17B) from the body (1) by pushing the stop pin with a rod.
- 1.3.4 Remove the hinge pin (17A) from the body (1) by pushing the hinge pin with a rod.
When pushing out the hinge pin (17A), press and hold the spring (124) toward the disc (4A).
After pushing out the hinge pin (17A), the disc (4A), the spring (124), and the washers (47, 58A, 58B) will come off accordingly.
- 1.3.5 Take out the disc (4A), the spring (124) and the washers (47, 58A, 58B) from the body (1).

1.4 Disassembly procedures for two-piece semicircle disc type (Nominal size 150A and over)

- 1.4.1 Remove the nuts (33) from the hinge pin (17A) and the stop pin (17B).
- 1.4.2 Remove the seal washers (174) from the hinge pin (17A) and the stop pin (17B).
- 1.4.3 Remove the stop pin (17B) from the body (1) by pushing it with a rod.
- 1.4.4 Remove the hinge pin (17A) from the body (1) by pushing it with a rod.
When pushing out the hinge pin (17A), press and hold the spring (124) toward the disc (4A) so that the spring does not leap out.
After pushing out the hinge pin (17A), the disc (4A), the spring (124), and the washers (47, 58) will come off accordingly.
- 1.4.5 Take out the disc (4A), the spring (124) and the washers (47, 58) from the body (1).



1.5 Disassembly procedures for one-piece circle disc type

- 1.5.1 Remove the plug (18) from the body (1).
- 1.5.2 Pull out the pin (17) from the body (1). Press and hold the spring (124) toward the disc (4A) with fingers.
- 1.5.3 Take out the disc (4A) and the spring (124) from the body (1).

VII. Disassembly and Assembly

2. Assembly Procedures

2.1 Precautions for safety

 CAUTION	
	<ul style="list-style-type: none">(1) Wear protective items such as goggles, gloves and working boots.(2) No fire is allowed in the working area.(3) Pay attention not to catch your fingers during assembly.(4) Replace the packing and the gasket with new ones for satisfactory sealing performance.

2.2 Notes for assembly

2.2.1 Check all parts before assembly. Replace the parts or valve if needed.

2.2.2 If the parts are reused, clean them to remove oil, dust and other foreign objects.

2.2.3 Assemble the valve in a dust-free area.

2.2.4 Care should be taken not to damage the body seat, the disc seat and the gasket contact surfaces.

2.2.5 All threaded parts should be securely tightened.

VII. Disassembly and Assembly

2.3 Assembly procedures for two-piece semicircle disc type (Size 125A and below)

- 2.3.1 Install the disc (4A) to the body (1).
- 2.3.2 Put the spring (124) to the disc (4A) and press and hold the spring coil toward the disc.
- 2.3.3 Set the washer (47) between the body (1) and the disc (4A), and set the washer (58A) between the two discs (4A and 4B), and the washer (58B) between the springs (124).
- 2.3.4 Put the hinge pin (17A) through the washers (47, 58A, 58B), the disc (4A) and the spring (124) so that the hinge pin (17A) is inserted in the body (1).
- 2.3.5 Insert the stop pin (17B) in the body (1) while pulling the tip side of the spring pin (124) toward the stop pin (17B).
- 2.3.6 Attach the spacer (80) to the body (1), where the hinge pin (17B) and the stop pin (17B) are inserted, for both sides.
- 2.3.7 Wind the seal tape to the threaded part of the plugs (85).
- 2.3.8 Attach the plug (85) to the body (1) firmly.

2.4 Assembly procedures for two-piece semicircle disc type (Size 150A and over)

- 2.4.1 Install the disc (4A) to the body (1).
- 2.4.2 Put the spring (124) to the disc (4A) and press and hold the spring coil toward the disc.
- 2.4.3 Set the washer (47) between the body (1) and the disc (4A), and set the washer (58) between the springs (124).
- 2.4.4 Put the hinge pin (17A) through the washers (47, 58), the disc (4A) and the springs (124) so that the hinge pin (17A) is inserted in the body (1).
- 2.4.5 Insert the stop pin (17B) in the body (1) while pulling the tip side of the spring (124) toward the stop pin (17B).
- 2.4.6 Install the seal washers (174) to the both ends of the hinge pin (17A) and the stop pin (17B).
- 2.4.7 Attach the nuts (33) firmly to the both ends of the hinge pin (17A) and the stop pin (17B).

VII. Disassembly and Assembly

2.5 Assembly procedures for one-piece circle disc type

- 2.5.1 Install the disc (4A) to the body (1).
- 2.5.2 Set the spring (124) to the disc (4A). Then insert the pin (17) to the body (1) while pressing and holding the spring (124) toward the disc.
- 2.5.3 Wind the seal tape around the threaded part of the plug (18).
- 2.5.4 Attach the plug (18) to the body (1) firmly.

VII. Disassembly and Assembly

3. Structural drawing of two-piece semicircle disc type check valve (Size 125A and below)

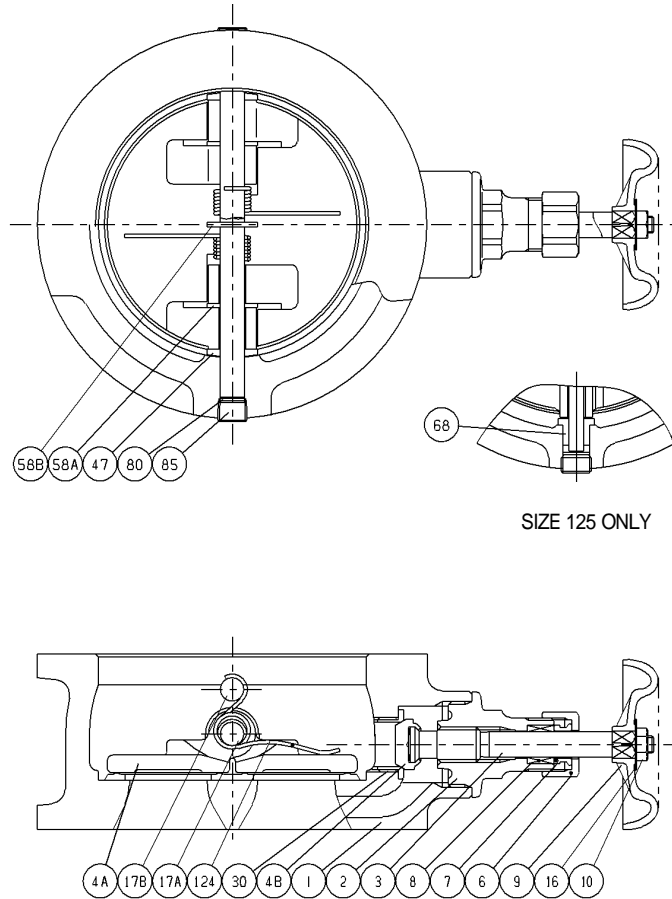

No.	Part Name
1	BODY
2	BONNET
3	STEM
4A	DISC
4B	DISC
6	PACKING NUT
7	GLAND
8	PACKING
9	HANDWHEEL
10	WHEEL NUT
16	NAME PLATE
17A	HINGE PIN
17B	STOP PIN
30	SEAT RING
47	WASHER
58A	WASHER
58B	WASHER
68	BUSHING
80	SPACER
85	PLUG
124	SPRING

This illustration shows a typical construction.
Please refer to the approved drawing for assembly and disassembly.

VII. Disassembly and Assembly

4. Structural drawing of two-piece semicircle disc type check valve (Size 150A and over)

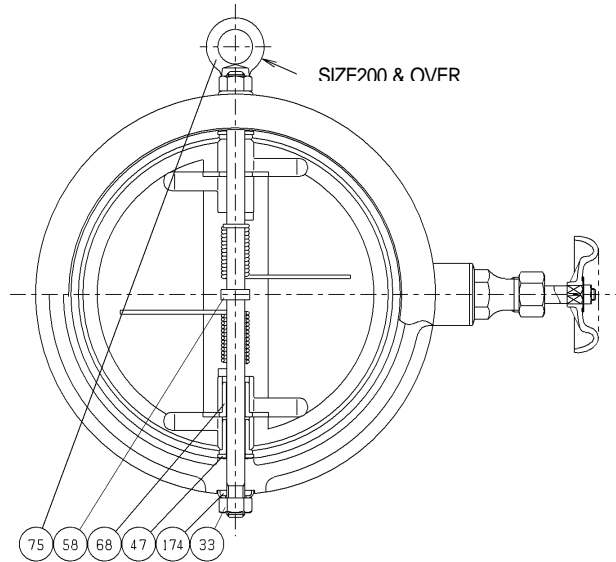

No.	Part Name
1	BODDY
2	BONNET
3	STEM
4A	DISC
4B	DISC
6	PACKING NUT
7	GLAND
8	PACKING
9	HANDWHEEL
10	WHEEL NUT
16	NAME PLATE
17A	HINGE PIN
17B	STOP PIN
30	SEAT RING
33	NUT
47	WASHER
58	WASHER
68	BUSHING
75	EYE BOLT
124	SPRING
174	SEAL WASHER

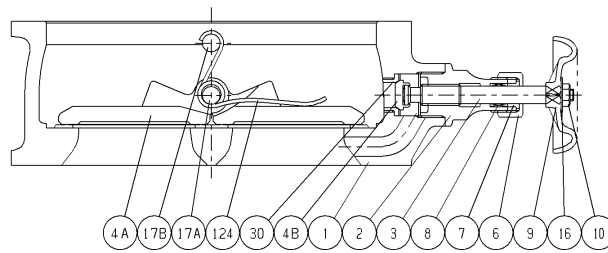

This illustration shows a typical construction.
Please refer to the approved drawing for assembly and disassembly.

VII. Disassembly and Assembly

5. Structural drawing of one-piece circle disc type check valve

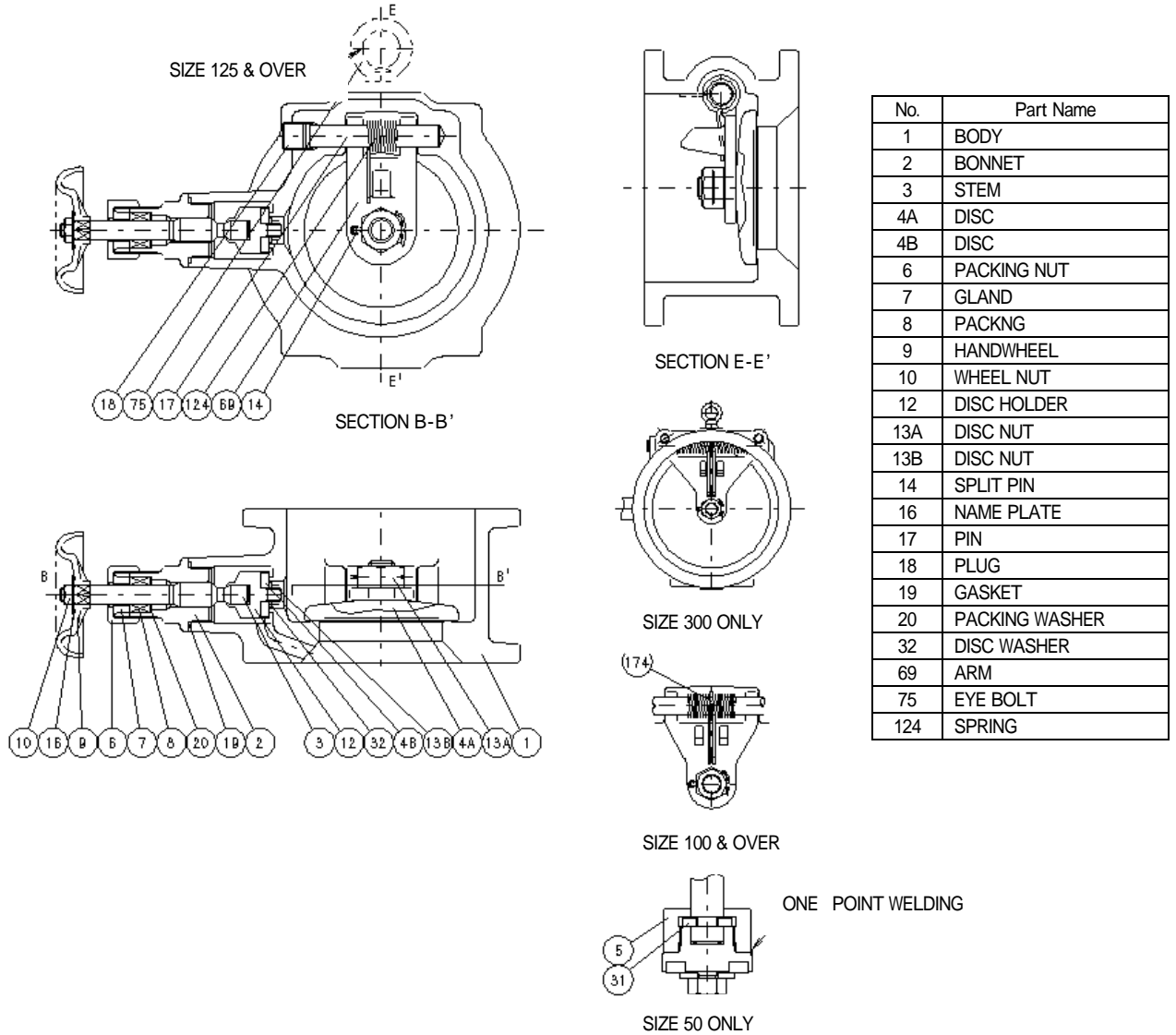

This illustration shows a typical construction.
Please refer to the approved drawing for assembly and disassembly.