KITZ

Operation and Maintenance Manual

For

**KITZ Carbon Steel, Low Alloy Steel, Stainless Steel
and Nickel Based Alloy**

Gate, Globe and Check Valves

(Flanged, Butt Welding, Threaded and Socket Welding Ends)

Thank you for having chosen KITZ products.

For safe and trouble-free function and performance of the product, ensure to read and understand all items of this manual before valve mounting and operation.

Keep this manual in a convenient place for your valve operators' easy access.

KITZ CORPORATION

This manual applies to the KITZ gate, globe and check valves made of carbon steel, low alloy steel, stainless steel and nickel based alloy.

This manual is prepared for manual valve operation.

For electric or pneumatic valve operation, refer to the operation manual prepared by the manufacturers of relevant valve actuators.

CAUTION AND WARNING

To ensure safe and trouble-free function and performance, please read all the contents of this manual before handling, transportation, mounting, operation and maintenance of valves. Keep this manual in a convenient place for your valve operators' easy access.

The signal words "WARNING" and "CAUTION" are defined as follows:

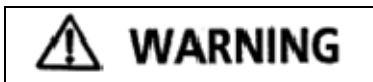

Indicates a potentially hazardous situation which, if not avoided, will result in death or serious injury.

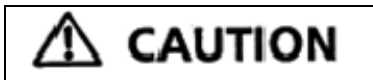

Indicates a potentially hazardous situation which, if not avoided, could result in minor or moderate injury.



Indicates a prohibited action that must not be carried out.



Indicates a mandatory action that must be carried out.

NOTES TO USERS

This manual covers the normal usage of the product. Technical data and instructions for operation, maintenance and inspection of the product are prepared in consideration of safety. However, they are good only to cover typical applications and provided as a general guideline to users. If technical assistance beyond the scope of this manual is required, contact KITZ Corporation.

The illustrations given in this manual do not introduce all details. If more detailed data is needed, refer to the relevant valve assembly drawings.

* Any information provided in this operation manual is subject to revision at any time without notice.

This edition cancels all previous issues.

C O N T E N T S

	Sheet	
I	Construction and Design Features	
	Gate Valves with Outside Screw and Yoke	2
	Globe Valves with Outside Screw and Yoke	3
	Swing Check Valves	4
	Lift Check Valves	5
II	Valve Operating Device	
	Handwheel	7
	Hammer Blow Handle	8
	Bevel Gear Operator	9
III	Transportation and Storage	10
IV	Valve Mounting	
	Flanged Type	14
	Butt Welding Type	18
	Threaded Type	21
	Socket Welding Type	25
V	Valve Operation	28
VI	Periodic Inspection	35
VII	Disassembly and Assembly	
	Gate Valves with Outside Screw and Yoke	42
	Globe Valves with Outside Screw and Yoke	47
	Swing Check Valves	52
	Lift Check Valves	57

CHAPTER I

Construction and Design Features

I Construction and Design Features

1. Gate Valves with Outside Screw and Yoke

- 1.1 The typical valve design is as illustrated below.
- 1.2 The threaded portion of the stem is exposed beyond the bonnet, known as outside screw. Rotation of the handwheel mounted on the stem top raises or lowers stem and disc together.
- 1.3 Clearance for stem rising is required for valve operation.
- 1.4 Outside screw designs have an advantage of better resistance against erosion and corrosion than inside screw designs because their stem threads are not in contact with service fluid.
- 1.5 Gate valves are designed for use in the fully open or fully closed position only. Services in intermediate position can damage valve disc and seats.
- 1.6 Fluid can flow through valve port in both directions.

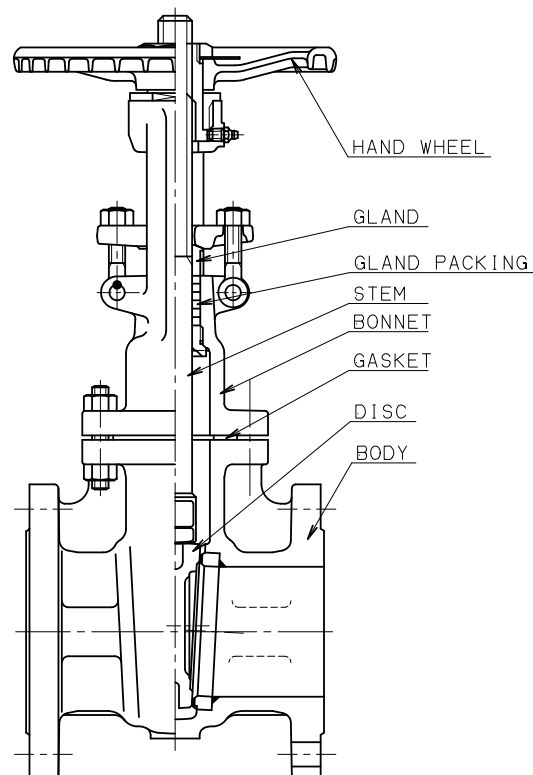

This illustration introduces a typical construction.

I Construction and Design Features

2. Globe Valves with Outside Screw and Yoke

- 2.1 The typical valve design is as illustrated below.
- 2.2 The threaded portion of the stem is exposed beyond the bonnet, known as outside screw. Rotation of the handwheel mounted on the stem top causes the handwheel to rise or fall together with the stem and disc.
- 2.3 Clearance for handwheel and stem rising is required for valve operation.
- 2.4 Outside screw designs have an advantage of better resistance against the erosion and corrosion than inside screw designs because their stem threads are not in contact with service fluid.
- 2.5 Globe valves are designed for use in the fully open, fully closed and intermediate positions for regulating services.
- 2.6 Globe valves have a high fluid resistance due to their design.
- 2.7 When the valve is in the closed position with flow under the seat, the fluid pushes against the disc and greater torque is required for operation.
- 2.8 Flow under the seat is the preferred direction of flow.

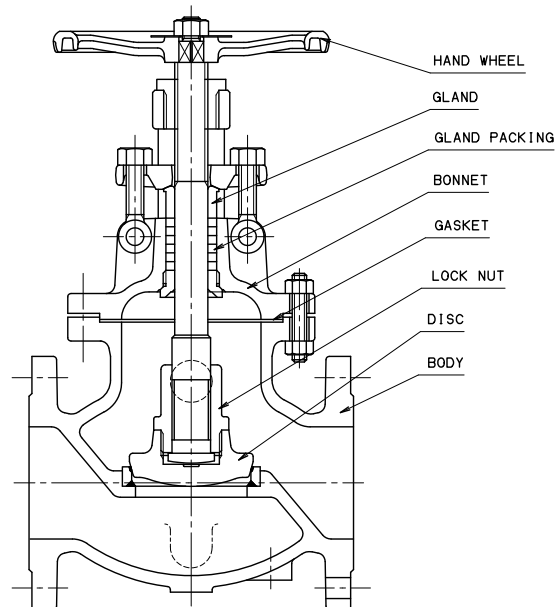

Flow Direction

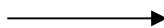

This illustration introduces a typical construction.

I Construction and Design Features

3. Swing Check Valves

3.1 The typical valve design is as illustrated below.

3.2 The hinge pin retains the arm and disc. The disc moves upwards with fluid flow.

With flow in one direction the disc hinges upward to permit flow through the valve. With reverse flow the disc is held closed.

3.3 Swing check valves permit flow in one direction and prevent the backflow.

3.4 Fluid can flow through valve port in one direction.

3.5 Swing check valves can be used both on horizontal and vertical piping.

On vertical piping, they can be used with upward flow and should be installed according to the arrow on the body.

On horizontal piping, they should be installed in upright position to pipe lines.

3.6 The disc may tend to float in the body and flap against the body seat due to a low volume of fluid flow, which is known as “chattering”.

3.7 Fluid vortex, turbulence and pulsation are expected at pump outlet and downstream of reducer and elbow, which may damage the valves and result in shortening life cycles of the valves.

It is recommended to place valves at the distance of 6 times nominal size or further from these devices.

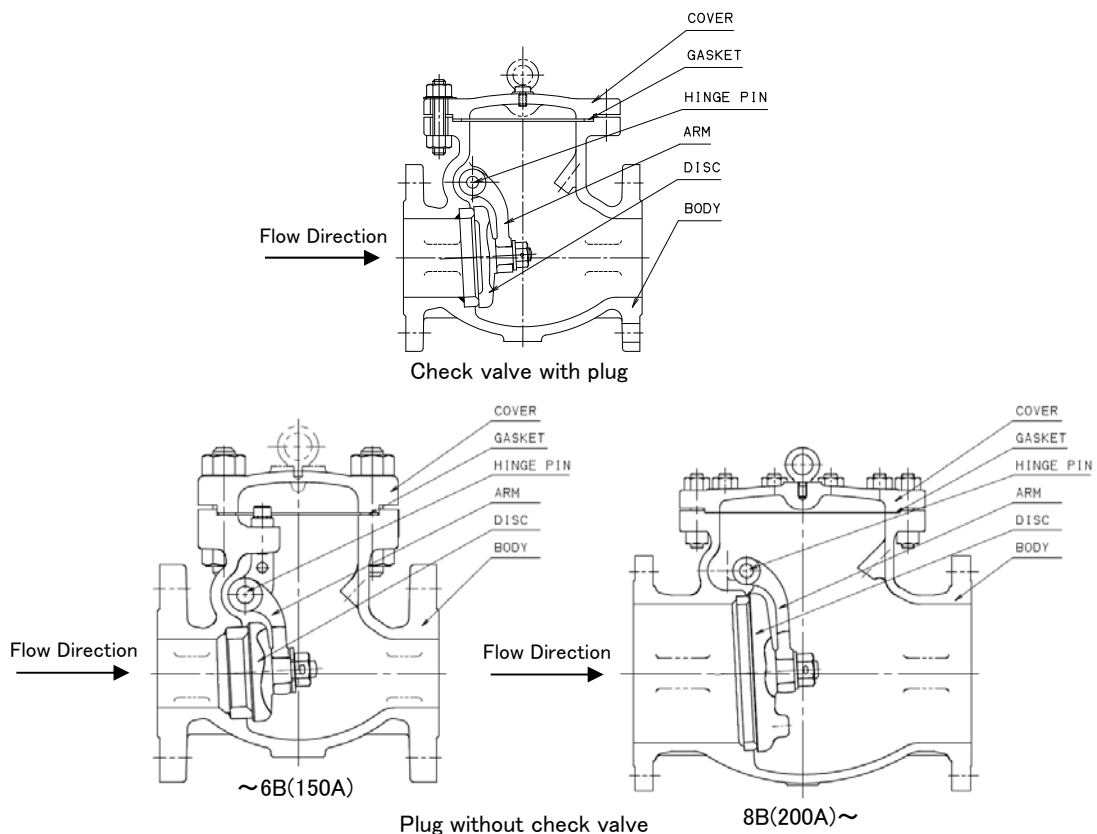

This illustration introduces a typical construction

I Construction and Design Features

4. Lift Check Valves

4.1 The typical valve design is as illustrated below.

4.2 The disc moves upward and downward along the guide provided with inside of the cover. With flow in one direction, the disc moves upward to permit flow through the valve. With reverse flow, the disc is held closed.

4.3 Lift check valves permit flow in a certain direction and prevent the backflow.

4.4 Fluid can flow through valve port in one direction.

4.5 Lift check valves can be used only on the horizontal piping with upright installation position to the piping.

4.6 The disc may tend to float in the body and flap on the body seat due to a low volume of fluid flow, which is known as “chattering” (See 3.6).

4.7 Fluid vortex, turbulence and pulsation are expected at pump outlet and downstream of reducer and elbow, which may damage the valves and result in shortening life cycles of the valves.

It is recommended to place valves at the distance of 6 times nominal size or further from these devices.

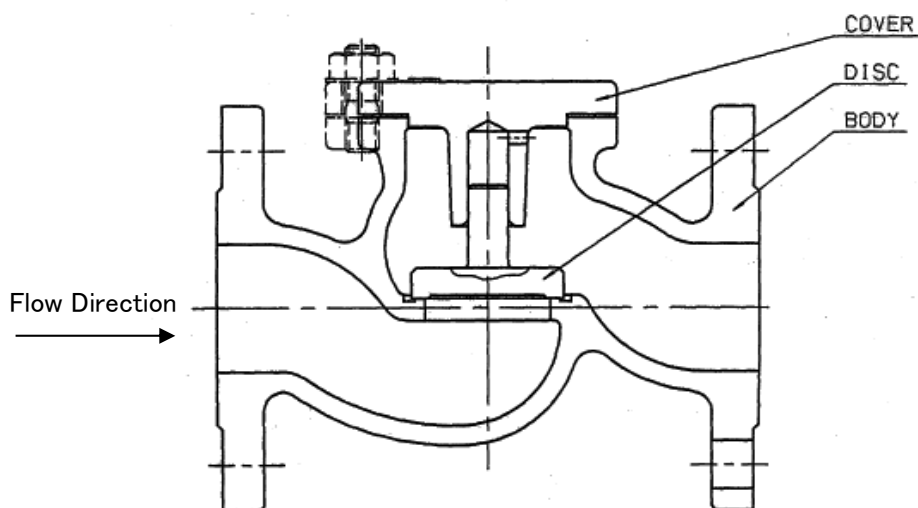

This illustration introduces a typical construction.

CHAPTER II

Valve Operating Device

II Valve Operating Device

1. Handwheel

- 1.1 The handwheel is directly mounted to the valve stem on globe valves and to the yoke sleeve on gate valves.
- 1.2 According to the arrow or letter on the handwheel, turning the handwheel clockwise closes the valve, and turning the handwheel counterclockwise opens the valve.
- 1.3 Handwheel operating torque depends on the type of valves, the direction for opening or closing, pressure in piping, and the tightening condition of the gland packing.

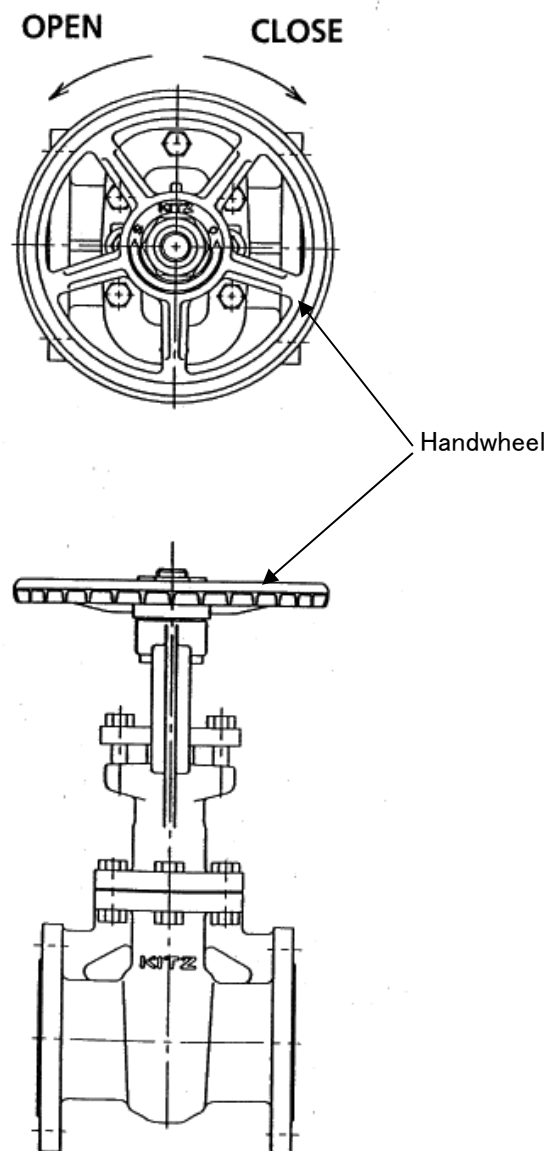

II Valve Operating Device

2. Hammer Blow Handle

- 2.1 The handwheel is directly mounted to the valve stem on globe valves and to the yoke sleeve on gate valves.
- 2.2 According to the arrow or letter on the handwheel, turning the handwheel clockwise closes the valve, and turning the handwheel counterclockwise opens the valve.
- 2.3 Handwheel operating torque depends on the type of valves, the direction for opening or closing, pressure in piping, and the tightening condition of the gland packing.
- 2.4 The impact generated by the blow of handwheel and boss converts the applied torque into a larger torque.
This is effective when a larger torque is immediately needed for the valve operation.
- 2.4.1 The rotation of the handwheel is transmitted through boss to stem.
- 2.4.2 A clearance (backlash) with the connecting area of handwheel and boss is furnished.
- 2.4.3 The clearance (backlash) helps hammer blow effect to increase the valve operator output.

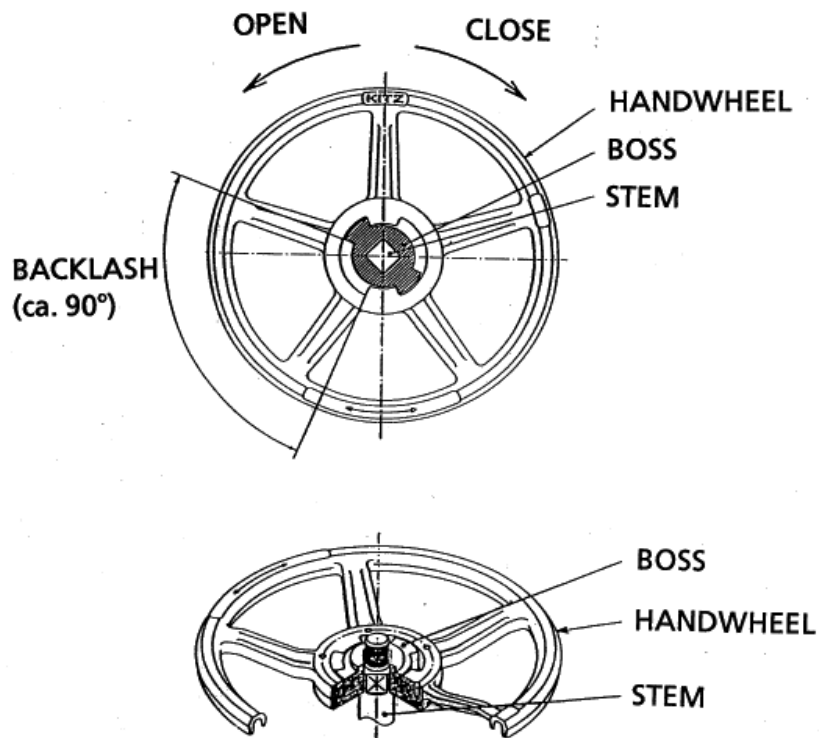

II Valve Operating Device

3. Bevel Gear Operator

- 3.1 For valve operation, the bevel gear operator is mounted on the valve.
- 3.2 According to the arrow or letter on the handwheel, turning the handwheel clockwise closes the valve, and turning the handwheel counterclockwise opens the valve.
- 3.3 Handwheel operating torque depends on the type of valves, the direction for opening or closing, pressure in piping, and the tightening condition of the gland packing.
- 3.4 Bevel gear operators are able to transmit a greater torque to valve stems, by converting the torque from drive shaft by means of a reduction gearing unit.
- 3.5 A similar mechanism to the hammer blow handle is built into the gear operator.
This is effective when a larger torque output is immediately needed for valve operation.

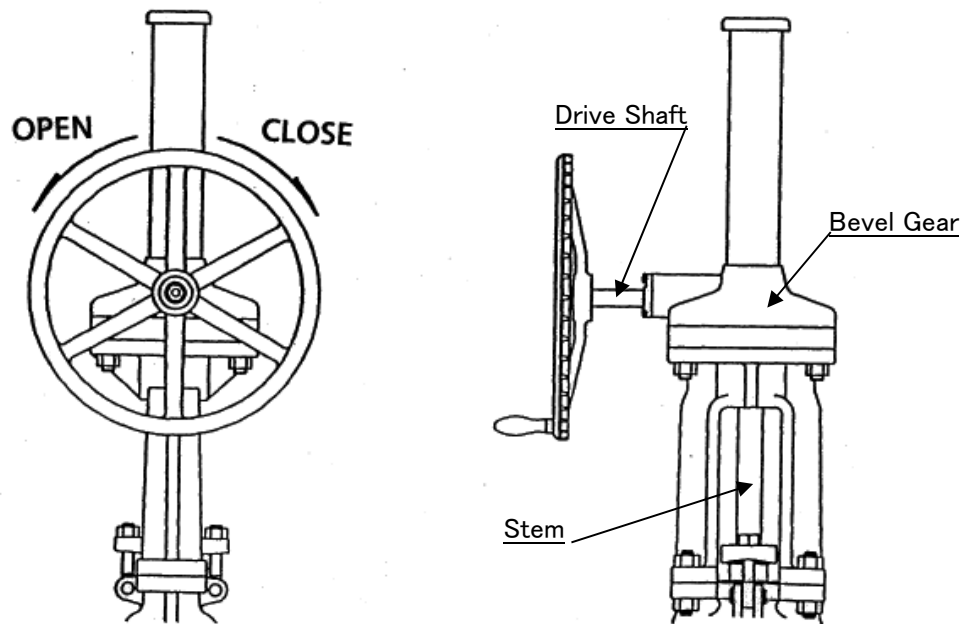



CHAPTER III



Transportation and Storage

III Transportation and Storage

1. Transportation

1.1 Cautions for safety

 WARNING	
	<ul style="list-style-type: none"> ● Keep off the valve lifting area to prevent personal injury caused by unsecured valves.

 CAUTION	
	<ul style="list-style-type: none"> ● Take care not to damage painting surface of valves during transportation, which may subsequently cause corrosion and rust. Any damaged surface should be adequately touched up before installation. ● Take care when handling carton packed products. High humidity may damage the cartons.

1.2 Transportation

1.2.1 Keep packages as they are delivered until installation.



If the protective covers are found missing during transportation, provide appropriate type of protective covers.

1.2.2 Handle valves carefully so that they may not fall or drop on the ground. Any extraordinary mechanical impact should be avoided.

III Transportation and Storage

2. Storage

2.1 Cautions for safety

 CAUTION	
	<ul style="list-style-type: none">● Do not store valves in a corrosive environment, which may cause corrosion on threaded portions of valves.● Do not remove protective covers until installation.● Do not place any other objects on valves, and do not step on them. Overloading may damage valves.● Do not pile up valves for storage. Unstable piling may damage the valves or cause personal injury.

2.2 Storage

2.2.1 Store valves in a dust-free, low humidity and well ventilated place.

Indoor storage is recommended.

2.2.2 Storage of valves directly on the ground or concrete floor is not recommended.

Packed valves should be placed on racks for storage.

2.2.3 If valves should be stored outdoors, take appropriate measures to prevent valves from direct exposure to dust, rain and sunlight.



CHAPTER IV



Valve Mounting

IV Valve Mounting

1. Flanged Type

1.1 Cautions for safety

 WARNING	
	<ul style="list-style-type: none"> ● Check the valve specifications with the catalogs and/or the attached nameplate. Services beyond the valve specifications may cause fluid leakage and valve malfunctions.
	<ul style="list-style-type: none"> ● Do not install valves for pipe end service. It may cause external leakage. In such a case, use a blank flange to prevent external leakage.

 CAUTION	
	<ul style="list-style-type: none"> ● Keep a secure footing for valve installation and operation. ● Appropriate level of lighting should be provided to the valve mounting area. ● Piping should be properly supported.

1.1.1 Allow sufficient room for operation, installation and subsequent maintenance of valves.

1.1.2 For smooth operation, inspection and maintenance, take appropriate actions for valves which are required to be installed in limited access locations.

1.1.3 Try not to install valves in locations where valve functionality may be hampered by such external forces, such as vibration and other.

1.1.4 It is recommended to install valves on horizontal piping in an upright position.



1.1.5 Swing check valves can be used both on horizontal and vertical piping.
When installed on vertical piping, they can be used only with upward flow.



1.1.6 Lift check valves can be used only on horizontal piping.

1.1.7 In oxidant service, the valves which used an expanded graphite gasket have max.400°C temperature restriction.
Check the oxidant service or not, and operation temperature.

IV Valve Mounting

1.2 Cautions for safety

 WARNING	
	<ul style="list-style-type: none">● Keep off the valve lifting area to prevent personal injury caused by unsecured valves.

 CAUTION	
	<ul style="list-style-type: none">● Take care not to catch fingers in flanges during mounting work.● Take care not to damage flange and seat surfaces.● Pipes should be properly supported, if needed.● Check valves are provided with stuffing inside for protection of the seat damage during transportation. Be sure to remove these stuffing completely before valve mounting.● In case of globe or check valves, the arrow on the valve body indicates the direction of fluid flow. Valves should be mounted according to this arrow. For gate valves with vent holes, vent holes should be positioned to the higher pressure side in fully closed position.● Retighten gland bolts before operation. Packing tightening stress may have been lowered due to the stress relaxation during transportation and storage, which may cause leakage problem from gland area.● Be sure to insert new gaskets between the valve and the pipe flange for valve mounting.● Retighten bolts at working temperatures to restore surface stress at sealing areas of valves used at high temperatures (+200°C and over).

IV Valve Mounting

1.2.1 Check the following items before valve mounting:

- (1) Service conditions should be within the range of the valve class and material specifications.
- (2) Valve flanges should correspond with piping flanges.
- (3) No scratch or defect should be found on the flange gasket surfaces.
- (4) The appropriate length should be secured between the pipe flanges with the valve face-to-face dimensions and gasket thickness taken into consideration.
- (5) Pipes should be aligned accurately.
- (6) Pipe flanges should face parallel to each other. Bolt holes of flanges should be arranged symmetrically such that they are lined up against the center line of flanges.

1.2.2 Before valve mounting, remove any foreign objects such as sand, dust and welding spatters from the connecting pipe interior.

1.2.3 Handle valves carefully so that they do not fall or drop on the ground. Any extraordinary mechanical impact should be avoided.

1.2.4 Remove protective covers just before valve mounting.

1.2.5 After valve mounting, all threaded portions should be checked.
Retighten them, if needed.

1.2.6 The valve and pipe interior should be flushed to remove foreign objects.
Do not operate valves during flushing.

IV Valve Mounting

1.3 Installation procedures

- 1.3.1 Make sure that pipes are aligned accurately.
- 1.3.2 The length between the pipe flanges should correspond with the valve face-to-face dimensions including gasket thickness.
- 1.3.3 Insert the valve between the pipe flanges. Thread bolts through bottom bolt holes and tighten bolts lightly.
- 1.3.4 Insert gaskets between the valve and the pipe flange. It is recommended to apply a gasket paste to gasket faces.

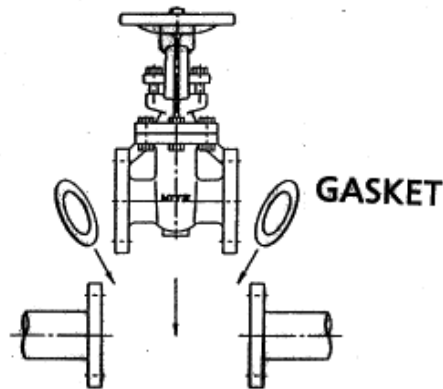

- 1.3.5 Make sure the correct alignment of gaskets, which are held by bottom bolts between the valve and the pipe flange.
- 1.3.6 Thread bolts through the other bolt holes and tighten them lightly.
- 1.3.7 Tighten bolts evenly, gradually and alternately on the diagonal line shown as follows. The ends of all tightened bolts should protrude equally beyond the nuts.

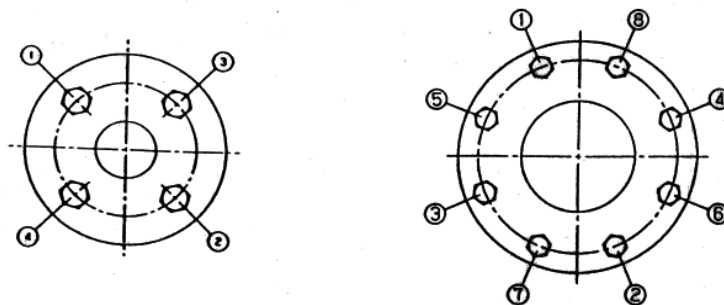





- 1.3.8 Raise the line temperature and increase pressure gradually on test operation. Retighten the threaded portions, if needed.

IV Valve Mounting

2. Butt Welding Type

2.1 Cautions for safety

 WARNING	
	<ul style="list-style-type: none"> ● Check the valve specifications with the catalogs and/or the attached nameplate. Services beyond the valve specifications may cause fluid leakage and valve malfunctions.
	<ul style="list-style-type: none"> ● Do not install valves for pipe end service. It may cause external leakage.

 CAUTION	
	<ul style="list-style-type: none"> ● Keep a secure footing for valve installation and operation. ● Appropriate level of lighting should be provided to the valve mounting area. ● Piping should be properly supported.

2.1.1 Allow sufficient room for operation, installation and subsequent maintenance of valves.

2.1.2 For smooth operation, inspection and maintenance, take appropriate actions for valves which are required to be installed in limited access locations.



2.1.3 Try not to install valves in locations where valve functionality may be hampered by external forces, such as vibration and other.



2.1.4 It is recommended to install valves on horizontal piping in an upright position.

2.1.5 Swing check valves can be used both on horizontal and vertical piping.
When installed on vertical piping, they can be used only with upward flow.

IV Valve Mounting

2.2 Cautions for safety

 WARNING	
	<ul style="list-style-type: none"> ● Keep off the valve lifting area to prevent personal injury caused by unsecured valves.

 CAUTION	
	<ul style="list-style-type: none"> ● Take care not to damage butt welding ends and seat surfaces. ● Pipes should be properly supported, if needed. ● Check valves are provided with stuffing inside for protection of the seat damage during transportation. Be sure to remove these stuffing completely before valve mounting. ● In case of globe or check valves, the arrow on the valve body indicates the direction of fluid flow. Valves should be mounted according to this arrow. For gate valves with vent holes, vent holes should be positioned to the higher pressure side in fully closed position. ● Retighten gland bolts before operation. Packing tightening stress may have been lowered due to the stress relaxation during transportation and storage, which may cause leakage from gland area. ● Retighten bolts at working temperatures to restore surface stress at sealing areas for valves used at high temperatures (+200°C and over).

2.2.1 The service conditions should be within the range of the valve class and material specifications.

2.2.2 Before valve mounting, remove sand, dust and welding spatters from the connecting pipe interior.

2.2.3 Handle valves carefully so that they may not fall or drop on the ground. Any extraordinary mechanical impact should be avoided.

2.2.4 Remove protective covers just before valve mounting.

2.2.5 After valve mounting, all threaded portion should be checked. Retighten them, if needed.

2.2.6 The valve and pipe interior should be flushed to remove foreign objects.
Do not operate the valve during flushing.

IV Valve Mounting

2.3 Cautions for welding work



To prevent valve damage from overheating, welding work should be made carefully according to the following cautions:



- 2.3.1 Valve should be welded with the disc slightly opened.
- 2.3.2 All welding work for mounting valves on the pipeline should be made by qualified welders in accordance with the qualified welding procedures.
- 2.3.3 Select appropriate welding rods for valves and piping materials.
If covered welding rods are used, check that they are stored and dried appropriately.
- 2.3.4 It is recommended to use back-shielding gas for the first layer of welding.
- 2.3.5 Visual inspection or non-destructive examinations are required to check weld cracks, overlaps and undercut or other defects.
- 2.3.6 Depending on the valve and pipe materials, heat treatment after welding may be required.
- 2.3.7 Valves should be protected from overheating by means of covering them with wet cloths.

IV Valve Mounting

3. Threaded Type

3.1 Cautions for safety

 WARNING	
	<ul style="list-style-type: none"> ● Check the valve specifications with the catalogs and/or the attached nameplate. Services beyond the valve specifications may cause fluid leakage and valve malfunctions.
	<ul style="list-style-type: none"> ● Do not install valves for pipe end service. It may cause external leakage.

 CAUTION	
	<ul style="list-style-type: none"> ● Keep a secure footing for valve installation and operation. ● Appropriate level of lighting should be provided to the valve mounting area. ● Piping should be properly supported, if needed.

3.1.1 Allow sufficient room for operation, installation and subsequent maintenance of valves.

3.1.2 For smooth operation, inspection and maintenance, take appropriate actions for valves which are required to be installed in limited access locations.



3.1.3 Try not to install valves in locations where valve functionality may be hampered by external forces, such as vibration and other.

3.1.4 It is recommended to install valves on horizontal piping in an upright position.

3.1.5 Swing check valves can be used both on horizontal and vertical piping.
When installed on vertical piping, they can be used only with upward flow.

3.1.6 Lift check valves can be used only on horizontal piping.

3.2 Cautions for safety

 WARNING	
	<ul style="list-style-type: none"> ● Keep off the valve lifting area to prevent personal injury caused by unsecured valves.

IV Valve Mounting**⚠ CAUTION**

- Take care not to damage threaded areas and seat surfaces.
- Do not disassemble valves during mounting work.
- Check valves are provided with stuffing for protection of the seat damage during transportation. Be sure to remove the stuffing completely before valve mounting.
- In case of globe or check valves, an arrow on the valve body indicates the direction of fluid flow. Valves should be mounted according to this arrow.
- Use sealing materials applicable to the temperature and the fluid at threaded areas.
- Use spanners or any other appropriate tools. It is prohibited to use a pipe wrench.
- Fit spanners on the valve ends to be connected with pipes. Do not fit them on the other ends.

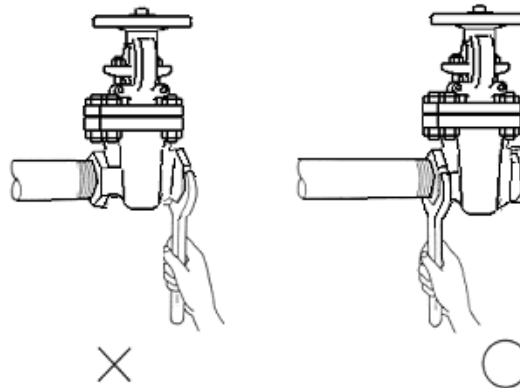

- Do not overtighten valves. It may damage valve internals.
- Retighten the gland bolts before operation. Packing tightening stress may be lowered due to the stress relaxation during transportation and storage, which may cause leakage problem from the gland area.
- Retighten bolts at working temperatures to restore surface stress at sealing areas for valves used at high temperatures (+200°C and over).

IV Valve Mounting

3.2.1 Check the following items before valve mounting:

- (1) Service conditions should be within the range of the valve class and material specifications.
- (2) Valve threads should correspond with piping threads.
- (3) No damage should be found on valve and piping threads.
- (4) Threads dimensions should correspond with the applicable standards.

3.2.2 Remove foreign objects such as sand, dust and welding spatters from the connecting pipe interior.

3.2.3 Handle valves carefully so that they do not fall or drop on the ground. Any extraordinary mechanical impact should be avoided.

3.2.4 Remove protective covers just before valve mounting.

3.2.5 After valve mounting, all threaded portions should be checked.
Retighten them, if needed.

3.2.6 The valve and pipe interior should be flushed to remove foreign objects.
Do not operate valves during flushing.

IV Valve Mounting

3.3 Installation procedures (threaded)

3.3.1 Make sure that valves and pipes are threaded properly.

3.3.2 Remove foreign objects such as cutting oil and spatters from pipe internals and threaded areas with detergent or waste cloth.

3.3.3 Apply sealing material such as sealing tape to the pipe threads.

3.3.4 Use appropriate tools to thread pipes into valves.

3.3.5 Do not apply any excessive torque to thread pipe ends into valves. Torques to be applied should be within the following ranges.

Nominal Size	A	6	8	10	15	20	25
	B	1/8	1/4	3/8	1/2	3/4	1
Torque N ·m		20 to 29	20 to 29	20 to 29	20 to 29	39 to 49	49 to 59



Nominal Size	A	32	40	50	65	80 and up
	B	1-1/4	1-1/2	2	2-1/2	3 and up
Torque N ·m		59 to 69	69 to 78	78 to 88	108 to 118	127 to 137



3.3.6 Raise the line temperature and increase pressure gradually on test operation. Retighten the threaded areas, if needed.

IV Valve Mounting

4. Socket Welding Type

4.1 Cautions for safety

 WARNING	
	<ul style="list-style-type: none"> ● Check the valve specifications with the catalogs and/or the attached nameplate. Services beyond the valve specifications may cause fluid leakage and valve malfunctions.
	<ul style="list-style-type: none"> ● Do not install valves for pipe end service. It may cause external leakage.

 CAUTION	
	<ul style="list-style-type: none"> ● Keep a secure footing for valve installation and operation. ● Appropriate level of lighting should be provided to the valve mounting area. ● Piping should be properly supported, if needed.

4.1.1 Allow sufficient room for operation, installation and subsequent maintenance of valves.

4.1.2 For smooth operation, inspection and maintenance, take appropriate actions for valves which are required to be installed in limited access locations.

4.1.3 Try not to install valves in locations where valve functionality may be hampered by external forces, such as vibration and other.



4.1.4 It is recommended to install valves on horizontal piping in an upright position.



4.1.5 Swing check valves can be used both on horizontal and vertical piping.
When installed on vertical piping, they can be used only with upward flow.

4.1.6 Lift check valves can be used only on horizontal piping.

IV Valve Mounting

4.2 Cautions for safety

 WARNING	
	<ul style="list-style-type: none"> ● Keep off the valve lifting area to prevent personal injury caused by unsecured valves.

 CAUTION	
	<ul style="list-style-type: none"> ● Take care not to damage socket welding ends and seat surfaces. ● Check valves are provided with stuffing inside for protection of the seat damage during transportation. Be sure to remove these stuffing completely before valve mounting. ● In case of globe or check valves, an arrow on the valve body indicates the direction of fluid flow. Valves should be mounted according to this arrow. For gate valves with vent holes, vent holes should be positioned to the higher pressure side in fully closed position. ● Retighten bolts at working temperatures to restore surface stress at sealing areas for valves used at high temperatures (+ 200°C and over). ● Retighten gland bolts before operation. Packing tightening stress may have been lowered due to the stress relaxation during transportation and storage, which may cause leakage from gland area.

- 4.2.1 The service conditions should be within the range of the valve class and material specifications.
- 4.2.2 Before valve mounting, remove foreign objects such as sand, dust and welding spatters from the connecting pipe interior.
- 4.2.3 Handle valves carefully so that they do not fall or drop on the ground. Any extraordinary mechanical impact should be avoided.
- 4.2.4 Remove protective covers just before valve mounting.
- 4.2.5 After valve mounting, all threaded portions should be checked. Retighten them, if needed.
- 4.2.6 The valve and pipe interior should be flushed to remove foreign objects. Do not operate valves during flushing.

IV Valve Mounting

4.3 Cautions for welding work

To prevent valves from overheating, welding work should be made carefully according to the following cautions.

- 4.3.1 Valves should be welded with the disc slightly opened.
- 4.3.2 All welding work for mounting valves on the pipeline should be made by qualified welders in accordance with the qualified welding procedures.
- 4.3.3 Select appropriate welding rods for valves and piping materials.
If covered welding rods are used, check that they are stored and dried appropriately.
- 4.3.4 It is recommended that the pipe be withdrawn approximately 1.6mm away from the bottom of the socket, when the pipe is seated against the bottom of the socket.

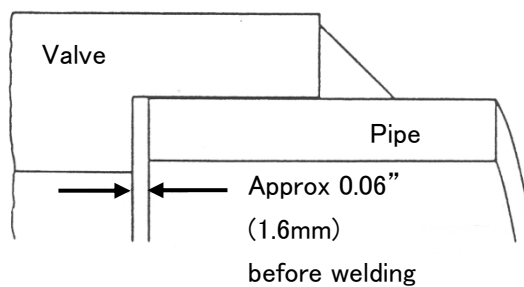



- 4.3.5 Visual inspection or non-destructive examinations are required to check weld cracks, overlaps and undercut or other defects.
- 4.3.6 Depending on the valve and pipe materials, heat treatment after welding may be required.
- 4.3.7 Valves should be protected from overheating by means of covering them with wet cloths.

CHAPTER V

Valve Operation

V Valve Operation

1. Cautions for safety

 CAUTION	
	<ul style="list-style-type: none"> ● Do not apply too much torque to the valve operating devices. ● Do not loosen bolts and nuts of gland and bonnet of pressurized valves. ● Do not operate gate valves in the intermediate position for a long period. It may damage the disc and seats.
	<ul style="list-style-type: none"> ● Open valves gradually to prevent damage of pipes, when the valve handles high temperature fluid such as steam. ● Close valves gradually to prevent water hammer, if the valve handles liquid fluid. ● Take appropriate measures to prevent valves and pipes from freezing.

2. Operation (Gate and Globe Valves)

- 2.1 Turn the handwheel clockwise according to the symbols or marks indicating the direction to close valves. Turn it counterclockwise to open them.
- 2.2 Operating torque depends on the type of valve, opening degree, and service conditions.
- 2.3 Be sure to turn the handwheel of gate valves back to the reverse direction by about 90° , when valves reach fully closed position. This is important in high temperature services to prevent thermal stress and enable valve reopening easier and smoother.

V Valve Operation

3. When the special tool illustrated below is used for the easy valve operation, do not apply too much torque to valves.

Refer to the following table for recommended maximum sizes of tools.

(Unit: mm)

Valve Nominal Size		Globe Valve		Gate Valve	
		JIS 10K ASME Class 150	JIS 20K ASME Class 300	JIS 10K ASME Class 150	JIS 20K ASME Class 300
(inch)	(mm)	Length (L)	Length (L)	Length (L)	Length (L)
1 1/2	40	70	185	80	130
2	50	100	200	80	200
2 1/2	65	200	285	150	300
3	80	225	460	150	320
4	100	380	650	250	440
5	125	660	1150	360	600
6	150	680		515	620
8	200	750		590	670
10	250			670	820
12	300			800	1040

Note) The table shown above quoted from “Guideline of Valve Handling”, fourth edition, issued by High Pressure Gas Safety Institute of Japan.

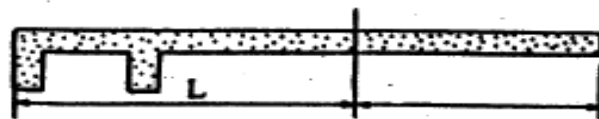

GRIP (Approx. 100 mm)

V Valve Operation

4. Daily Inspection

In order to operate your valves safety and satisfactorily, the daily inspection is very important. Here are the inspection items.

Periodic retightening of packing is necessary as a maintenance procedure.

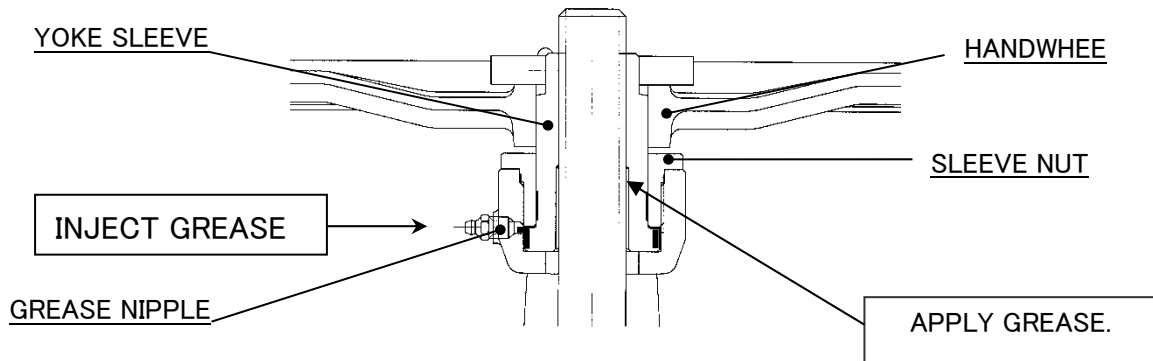

Items to be inspected	Valve type	Areas to be inspected	Inspection method	Recommended remedial measures
External leakage	Gate valves Globe valves	Gland area	Visual check Soap water	Retighten gland bolts. Replace gland packing.
	All	Flanged areas	Visual check Soap water	Retighten flange bolts. Replace gaskets.
		Threaded portions	Visual check Soap water	Retighten each threaded portion. Replace components as required.
		Body surface	Visual check Soap water	Replace the valve when excessive corrosion or damage is observed.
Abnormal noises	All	Valve body	Auditory check	Consult a piping engineer.
		Loosened bolts	Auditory check	Retighten bolts.
		Vibration of pipes	Auditory check	Consult a piping engineer
Loosened bolts and nuts	All	Bolts and nuts	Visual check Tactical check	Retighten bolts and nuts.
Seat leakage	All	-	-	Remove any foreign objects. Disassemble and inspect the valve components. (Lap the seat surfaces) Replace the valve.
Valve operation	Gate valves Globe valves	Operating position	Visual check	Make sure that the valve is in an appropriate predetermined position.
	All	Unsmooth operation	Test operation Auditory check	Lubricate the moving area. Disassemble and inspect the valve components.

V Valve Operation



This illustration shows injection and application of grease to the yoke sleeve section.

5. Remedial Measures

 CAUTION	
	<ul style="list-style-type: none"> ● Wear protective items such as goggles, gloves and working boots as required at work site. ● Take safety measures against toxic, flammable or corrosive fluids. ● Reduce line pressure to the atmospheric level before retightening gland and flange bolts and nuts. ● Operators should take protective measures to prevent direct exposure to the fluid, when the fluid spouts out from flanged areas. ● Reduce line pressure to the atmospheric level when the packing and gaskets are replaced or bolts and nuts are loosened. ● Loosen the gland bolts gradually, when the valve handles volatile fluid. ● If a packing leak is detected and tightening of gland bolting does not stop the leakage, backseat the stem to form a temporary stem seal. This is a temporary fix only, until a shutdown allows replacement of the stem packing under atmospheric pressures. It is not recommended to add or replace packing while a valve is in service.
	<ul style="list-style-type: none"> ● Do not apply lubricants to the pipes and valves which handle oxygen.

V Valve Operation

5.1 Leakage from the gland area

Retighten the gland bolts or nuts if the leakage is found from the gland area. If retightening the gland bolts or nuts cannot solve the leakage problem, the gland packing should be replaced with a new set.

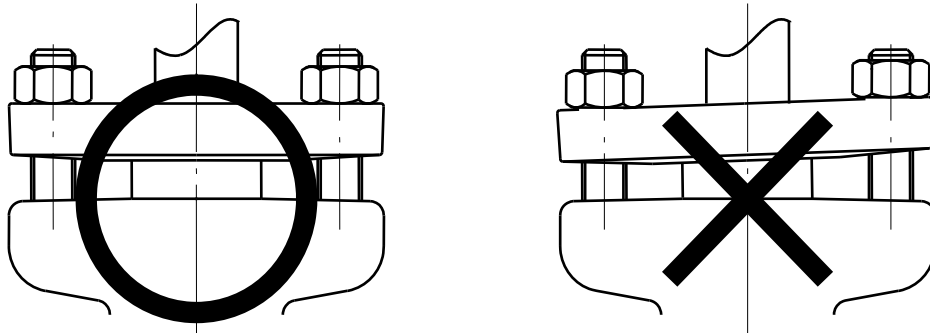

5.2 Leakage from the flange area

Tighten flange bolts evenly, gradually and alternately on the diagonal line shown as follows.

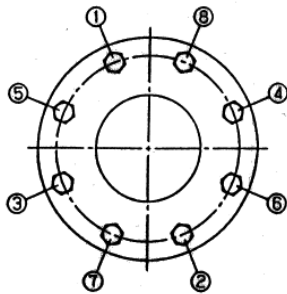

V Valve Operation

6. Troubleshooting

Trouble	Possible causes	Recommended remedial measures
Operation impossible	Threaded sections on the stem become stiff because the valve was not used for a long period.	Apply lubricant to the yoke sleeve and the stem screw engagement part. Injection grease through the grease nipple if applicable (see page 32/60).
	Foreign objects choke up the seats.	Flush out the foreign objects with fluid flow.
Unsmooth operation	Foreign objects adhere to the stem.	Remove the foreign objects and check the valve. Then, evenly apply grease to the threaded portions.
	Foreign objects choke up the valve cavity.	Flush out the foreign objects with fluid flow. Disassemble and inspect the valve components.
	Gland bolts and nuts are overtightened.	Loosen gland bolts and nuts and retighten them adequately.
Stem damage	Too much torque is applied.	Replace the damaged components.
Leakage from gland area	Gland bolts and nuts are loosened.	Retighten gland bolts and nuts.
	Gland bolts and nuts are tightened unevenly.	Tighten bolts and nuts evenly.
	Gland packing is damaged.	Replace the gland packing.
	Stem is damaged.	Replace the stem.
Leakage from seat area when the valve is in the fully closed position	Seats are damaged. (cavitation)	Consult the piping engineer.
	Seats are deformed.	Consult the piping engineer
Generation of abnormal noises and vibration	Bolts and nuts are loosened.	Retighten bolts and nuts.

CHAPTER VI
Periodic Inspection

VI Periodic Inspection

1. Periodic Inspection



- 1.1 It is recommended to carry out a periodic inspection about once a year against valves on pipes.
- 1.2 Ensure the smooth operation and sufficient valve function.
- 1.3 See Chapter V “Valve Operation” for inspection items and inspection methods.
- 1.4 Carry out the periodic inspection for valves which are not operated for a long period or not subjected to daily inspection.
- 1.5 It is extremely important to check any valves when such valves are used under the following services or conditions:
 - a) Where erosion and corrosion of valve interior are expected.
 - b) Where choking of fluid is expected.
 - c) Where performance failure of valves could result in a major shutdown of an entire plant.
- 1.6 It is recommended to replace the gland packing on periodic inspection.



VI Periodic Inspection

2. Maintenance and Inspection

In piping facilities where valves are installed and are to be set open for periodic maintenance and inspection, it is recommended to carry out leakage and operational tests. No internal/seat leakage and external leakage should be detected, and valves should operate smoothly without galling and sticking. If detecting any of above problems, disassemble and check the valve components. After reassembly, the above-mentioned tests should be carried out and results should be satisfactory.

2.1 Cautions for safety

 WARNING	
	<ul style="list-style-type: none"> ● Discharge fluid from the pipes and reduce the line pressure to atmospheric level. Trapped pressure of fluid is very dangerous and may cause accidents resulting in personal injury. ● In case of installation for pipe end service, fluid might be enclosed between the valve and the blank flange. Open the valve and discharge the fluid from the pipe before removing the blank flange. ● For gate valves, dismantle valves from piping with the valve in the intermediate position. Discharge fluid and pressure trapped within the fully closed valve body. ● Completely discharge toxic, flammable or corrosive fluid from pipe and valve interior. ● Operators must take protective measures against fluid spouting. No fire should be allowed in working area. ● Keep off the valve lifting area to prevent personal injury caused by unsecured valves.

 CAUTION	
	<ul style="list-style-type: none"> ● Wear protective items such as goggles, gloves and working boots. ● Keep a secure footing for valve dismantling and installation. ● Piping and valves should be properly supported, if needed. ● Before dismantling valves from the pipeline, mark the valve body and coupled pipe flanges with their original position. Reinstall the valve on pipes aligning these matchmarks after assembly. ● Be sure to insert new gaskets between the valve and the flange for valve mounting.

VI Periodic Inspection

2.2 Disassembly

Disassemble the valve according to the instructions in Chapter VII of this manual.

2.3 Each disassembled part should be inspected according to the following table.

Parts to be inspected	Valve types	Areas to be inspected	Items to be inspected	Inspection methods	Judgment	Remedial methods
body and bonnet	all	flanges	corrosion harmful damage crack	visual examination measurement of wall thickness	no corrosion no harmful damage no crack	weld repair*
		wetted areas	corrosion scratch crack	visual examination measurement of wall thickness NDE	no corrosion minimum wall thickness	weld repair*
seat and disc	gate	disc guide	corrosion erosion	visual examination	smooth operation	weld repair and machining
	all	seat surfaces	corrosion scratch crack erosion	visual examination	no corrosion no harmful damage good lapping	lapping
			corrosion erosion	visual examination	smooth operation	weld repair and machining
	gate	disc guide	corrosion deformation	visual examination	no corrosion no deformation	replacement of the disc
	globe	lock nut	corrosion	visual examination	no corrosion	replacement
			sliding area of disc & cover/arm	tactical examination	smooth operation	grinding
check		moving area of hinge pin & arm	tactical examination	smooth operation	grinding	

* Replace the valve, if weld repair is impossible.

VI Periodic Inspection

Parts to be inspected	Valve types	Areas to be inspected	Items to be inspected	Inspection methods	Judgment	Remedial methods
stem	gate globe	stem	corrosion erosion scratch deformation	visual examination measurement	no corrosion no scratch no deformation	replacement repair
		threaded areas	corrosion erosion	visual examination	no corrosion no erosion	replacement
stuffing box	gate globe	inside surface of stuffing box	corrosion erosion scratch	visual examination	no corrosion no erosion no scratch	replacement
gland packing gasket	gate globe	gland packing gasket	deterioration	visual examination	replacement (once a year)	replacement
yoke sleeve yoke bush	gate globe	sliding areas	smooth operation	tactual examination	smooth operation	repair and lubrication
		threaded areas	erosion	visual examination	no erosion	replacement
		shoulder	crack deformation	visual examination	no crack no deformation	replacement

2.4 Assembly

Assemble the valve according to the instructions in Chapter VII of this manual.

VI Periodic Inspection

2.5 Tests and Inspections



The following are main items required for tests and inspections of valves.

2.5.1 Operation test

- (1) The valve should be operated smoothly by handwheel without galling or sticking.
- (2) The stem should be firmly connected with the disc.
- (3) For gate valves, when they are fully closed, the center of the disc should be located upwards from the center of the body seat. And when they are fully opened, the lower end of the disc should not protrude into the port of the valve.
- (4) For globe valves, the disc should be seated and aligned on the body seats perfectly, when the valve is fully closed. No misalignment or offset of disc and seat center shall be acceptable.
- (5) For check valves, the disc should move smoothly. And when valves are fully opened, the disc should be stopped against the stopper provided in the valve body.

2.5.2 Shell test and seat leakage test

- (1) Cautions for shell test and seat leakage test

 CAUTION	
	<ul style="list-style-type: none"> ● Wear protective items such as goggles, gloves and working boots. ● Take sufficient precautions before performing shell test and seat leakage test for operator's safety.

- (2) Shell test and seat leakage test

All valves are subjected to a hydrostatic or pneumatic shell test and seat leakage test at the required test pressure after assembly.

Refer to the JIS B 2003, JPI-7S-39 or API 598 for test methods.

CHAPTER VII



Disassembly and Assembly



VII Disassembly and Assembly

1. Gate Valves with Outside Screw and Yoke

1.1 Disassembly

1.1.1 Cautions for safety

 WARNING	
	<ul style="list-style-type: none">● Operators must take protective measures to prevent direct exposure to the fluid, when the fluid spouts out from valves.

 CAUTION	
	<ul style="list-style-type: none">● Wear protective items such as goggles, gloves and working boots.● Take care not to catch fingers in flanges during disassembly.● When disassembling valves of large sizes, use an appropriate machine to lift up valves.

1.1.2 Before disassembly

- (1) Disassemble the valve in a dust-free place.
- (2) Take care not to damage the seat surfaces, stem threads and flange surfaces.
- (3) Make matchmarks on the body and bonnet flanges for realignment during assembly.
Also the disc and body should be marked, so that the disc can be mounted in the original position.

VII Disassembly and Assembly

1.1.3 Disassembly



Note: see sheet 46/60 for reference figure.

- (1) Open the valve to the intermediate position.
- (2) Loosen the wheel nuts.
- (3) Loosen the gland nuts.
- (4) Remove the bonnet bolts and nuts.
- (5) Remove the bonnet upwards from the body slowly. The stem and disc come up together with the bonnet. Care should be taken not to drop the disc into the body. Check and mark the disc original position.
- (6) Remove the disc from the stem.
- (7) Remove the gasket from the bonnet flange.
- (8) Turn the handwheel clockwise to disengage the stem from the yoke sleeve.
- (9) Remove the stem from the bonnet.
- (10) Remove the gland nuts, gland, gland packing and other auxiliary parts.
- (11) Remove the wheel nut, handwheel and yoke sleeve and other auxiliary parts.

VII Disassembly and Assembly

1.2 Assembly

1.2.1 Caution for safety

 CAUTION	
	<ul style="list-style-type: none"> ● Wear protective items such as goggles, gloves and working boots. ● No fire should be allowed in working area. ● Take care not to catch fingers in flanges during assembly. ● Replace the packing and gasket with new ones to ensure satisfactory sealing performance. ● When assembling valves of large size, use appropriate machine to lift up valves.
	<ul style="list-style-type: none"> ● Do not apply lubricants to the pipes and valves which handle oxygen.

1.2.2 Before assembly

- (1) The consumables should be prepared before assembly.
- (2) Clean parts to remove dust and other foreign objects.
- (3) Assemble the valve in a dust-free place.
- (4) Take care not to damage the seat surfaces, stem threads and flange surfaces.
- (5) Assemble the valve aligning the matchmarks provided before disassembly.
- (6) All bolts and nuts should be tightened securely.

VII Disassembly and Assembly

1.2.3 Assembly

Note: see sheet 46/60 for reference figure.

- (1) Mount the yoke sleeve, handwheel and other auxiliary parts on the bonnet, and tighten the wheel nut.
- (2) Assemble the gland packing, gland and other auxiliary parts with bonnet. Tighten gland bolts and nuts temporarily.
- (3) Assemble the stem with bonnet, and engage the stem threads with yoke sleeve. Turn the handwheel counterclockwise to the intermediate position.
Apply the anti-seize lubricants such as Molybdenum disulfide grease.
- (4) Mount the gasket on the bonnet flange.
- (5) Assemble the disc with stem, and place them inside the body according to the disc guide. Make sure the disc original position is aligned according to the coupling matchmarks provided before disassembly.
- (6) Tighten bonnet bolts and nuts evenly, gradually and alternately on the diagonal line. The end of each tightened bolt should protrude equally beyond the nut.
- (7) Tighten gland nuts adequately. Too much tightening may cause unsmooth operation.
- (8) Check each threaded portion. Retighten them, if found loosened.

VII Disassembly and Assembly

1.3 Assembly Illustration

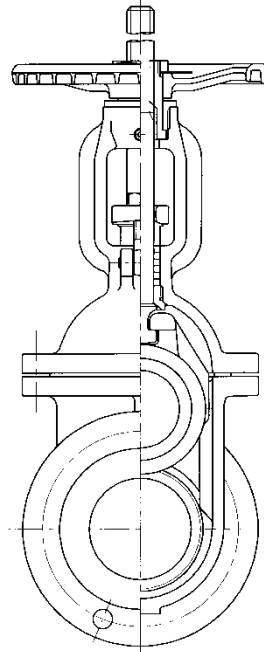
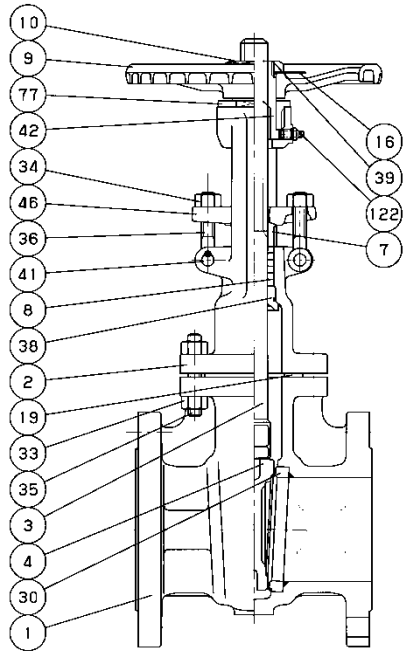

No.	Parts Name
1	Body
2	Bonnet
3	Stem
4	Disc
7	Gland
8	Gland Packing
9	Handwheel
10	Wheel Nut
16	Name Plate
19	Gasket
30	Body Seat Ring
33	Bonnet Nut
34	Gland Nut
35	Bonnet Bolt
36	Gland Bolt
38	Bonnet Bush
39	Set Screw
41	Gland Bolt Pin
42	Yoke Sleeve
46	Gland Flange
77	Sleeve Nut
122	Grease Nipple



This illustration introduces a typical construction.
 Refer to the approval drawing before disassembly and assembly.



VII Disassembly and Assembly

2. Globe Valves with Outside Screw and Yoke

2.1 Disassembly

2.1.1 Cautions for safety

 WARNING	
	<ul style="list-style-type: none">● Operators must take protective measures to prevent direct exposure to the fluid, when the fluid spouts out from valves.

 CAUTION	
	<ul style="list-style-type: none">● Wear protective items such as goggles, gloves and working boots.● Take care not to catch fingers in flanges during disassembly.● When disassembling valves of large sizes, use an appropriate machine to lift up valves.

2.1.2 Before disassembly

- (1) Disassemble the valve in a dust-free place.
- (2) Take care not to damage the seat surfaces, stem threads and flange surfaces.
- (3) Matchmark the body and bonnet flanges for easy assembly.

VII Disassembly and Assembly

2.1.3 Disassembly



Note: see sheet 51/60 for reference figure.

- (1) Open the valve to the intermediate position.
- (2) Loosen the wheel nuts.
- (3) Loosen the gland nuts.
- (4) Remove the bonnet bolts and nuts.
- (5) Remove the bonnet upwards from the body slowly. The stem and disc come up together with the bonnet.
- (6) Remove the gasket from the bonnet flange.
- (7) Turn the handwheel clockwise till the handwheel is contacted with the yoke bush.
- (8) Remove the wheel nut, handwheel and other auxiliary parts.
- (9) Turn the stem clockwise to disengage it from the yoke bush.
- (10) Remove the stem from the bonnet.
- (11) Remove the gland nuts, gland, gland packing and other auxiliary parts.

VII Disassembly and Assembly

2.2 Assembly

2.2.1 Caution for safety

 CAUTION	
	<ul style="list-style-type: none"> ● Wear protective items such as goggles, gloves and working boots. ● No fire should be allowed in working area. ● Take care not to catch fingers in flanges during assembly. ● Replace the packing and gasket with new ones to ensure satisfactory sealing performance. ● When assembling valves of large size, use appropriate machine to lift up valves.
	<ul style="list-style-type: none"> ● Do not apply lubricants to the pipes and valves which handle oxygen.

2.2.2 Before assembly

- (1) The consumables should be prepared before assembly.
- (2) Clean parts to remove dust and other foreign objects.
- (3) Assemble the valve in a dust-free place.
- (4) Take care not to damage the seat surfaces, stem threads and flange surfaces.
- (5) Assemble the valve aligning the matchmarks provided before disassembly.
- (6) All bolts and nuts should be tightened securely.

VII Disassembly and Assembly

2.2.3 Assembly

Note: see sheet 51/60 for reference figure.

- (1) Assemble the gland packing, gland and other auxiliary parts, and tighten gland bolts and nuts temporarily.
- (2) Assemble the stem with the bonnet, and engage the stem threads with the yoke bush. Turn the stem counterclockwise to the intermediate position. Apply the anti-seize lubricants such as Molybdenum disulfide grease.
- (3) Mount the handwheel on the stem, and secure it with the wheel nut.
- (4) Mount the gasket on the bonnet flange.
- (5) Assemble the bonnet with the body aligning with the coupling matchmarks provided before disassembly.
- (6) Tighten bonnet bolts and nuts evenly, gradually and alternately on the diagonal line. The end of each tightened bolt should protrude equally beyond the nut.
- (7) Tighten gland nuts adequately. Too much tightening may cause unsmooth operation.
- (8) Check each threaded portion. Retighten them, if found loosened.

VII Disassembly and Assembly

2.3 Assembly Illustration

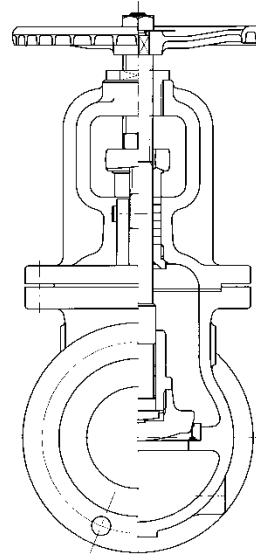
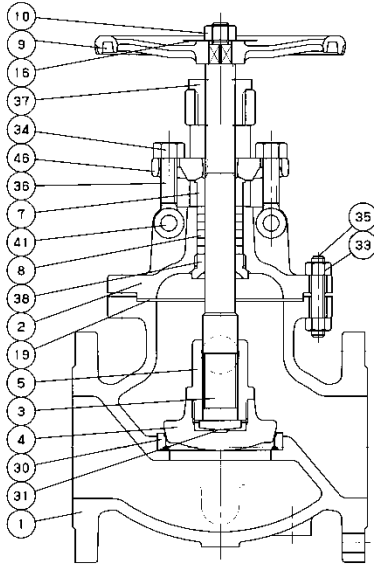

No.	Parts Name
1	Body
2	Bonnet
3	Stem
4	Disc
5	Lock Nut
7	Gland
8	Gland Packing
9	Handwheel
10	Wheel Nut
16	Name Plate
19	Gasket
30	Body Seat Ring
31	Stem Washer
33	Bonnet Nut
34	Gland Nut
35	Bonnet Bolt
36	Gland Bolt
37	Yoke Bush
38	Bonnet Bush
41	Gland Bolt Pin
46	Gland Flange



This illustration introduces a typical construction.
 Refer to the approval drawing before disassembly and assembly.



VII Disassembly and Assembly

3. Swing Check Valves

3.1 Disassembly

3.1.1 Cautions for safety

 WARNING	
	<ul style="list-style-type: none"> ● Operators must take protective measures to prevent direct exposure to the fluid, when the fluid spouts out from valves.

 CAUTION	
	<ul style="list-style-type: none"> ● Wear protective items such as goggles, gloves and working boots. ● Take care not to catch fingers in flanges during disassembly. ● When disassembling valves of large sizes, use an appropriate machine to lift up valves.

3.1.2 Before disassembly

- (1) Disassemble the valve in a dust-free place.
- (2) Take care not to damage the seat surfaces and flange surfaces.
- (3) Matchmark the body and cover flanges for easy assembly.

3.1.3 Disassembly



Note: see sheet 55/60 for reference figure.

- (1) Remove the cover nuts.
- (2) Remove the cover.
- (3) Remove the gasket.
- (4) Remove the plug. (Only check valve with plug)
- (5) Remove the hinge pin which remains hanging the disc. (Only check valve with plug)
Remove the hinge pin that hangs the disc or the hinge pin holder that hangs the hinge pin.
(Only check valve without plug)
Support the disc by hand to remove the hinge pin.
- (6) Remove the disc from inside of body.

VII Disassembly and Assembly

3.2 Assembly

3.2.1 Caution for safety

 CAUTION	
	<ul style="list-style-type: none"> ● Wear protective items such as goggles, gloves and working boots. ● No fire should be allowed in working area. ● Take care not to catch fingers in flanges during assembly. ● Replace the gasket with new ones to ensure satisfactory sealing performance. ● Replace the toothed washer or bolt stopper with a new one to ensure sufficient bolt loosening performance.(Only check valve without plug) ● When assembling valves of large size, use appropriate machine to lift up valves.
	<ul style="list-style-type: none"> ● Do not apply lubricants to the pipes and valves which handle oxygen.

3.2.2 Before assembly

- (1) The consumables should be prepared before assembly.
- (2) Clean parts to remove the dust and other foreign objects.
- (3) Assemble the valve in a dust-free place.
- (4) Take care not to damage the seat surfaces and flange surfaces.
- (5) Assemble the valve aligning the matchmarks provided before disassembly.
- (6) All bolts and nuts should be tightened securely.

VII Disassembly and Assembly

3.2.3 Assembly

Note: see sheet 55/60, 56/60 for reference figure.

- (1) Insert the disc-arm sub-assembly into body.
- (2) Assemble the hinge pin with the disc-arm sub-assembly completely through the body hole. (Only check valve with plug)
Attach the hinge pin holder or hinge pin to the main unit and assemble it to the disk arm subassembly. (Only plug without check valve)
- (3) Mount the gasket between the plug and the body. Assemble the plug with body.
(Only check valve with plug)
Bend the new bolt stopper's collar to touch the bolt head plane.
(Bolt stopper mounted valve only)
- (4) Mount the gasket on the cover flange.
- (5) Assemble the cover with the body aligning matchmarks provided before disassembly.
- (6) Tighten cover bolts and nuts evenly, gradually and alternately on the diagonal line. The end of each tightened bolt should protrude equally beyond the nut.
- (7) Check each threaded portion. Retighten them, if found loosened.

VII Disassembly and Assembly

3.3 Assembly Illustration

3.3.1 Check valve with plug

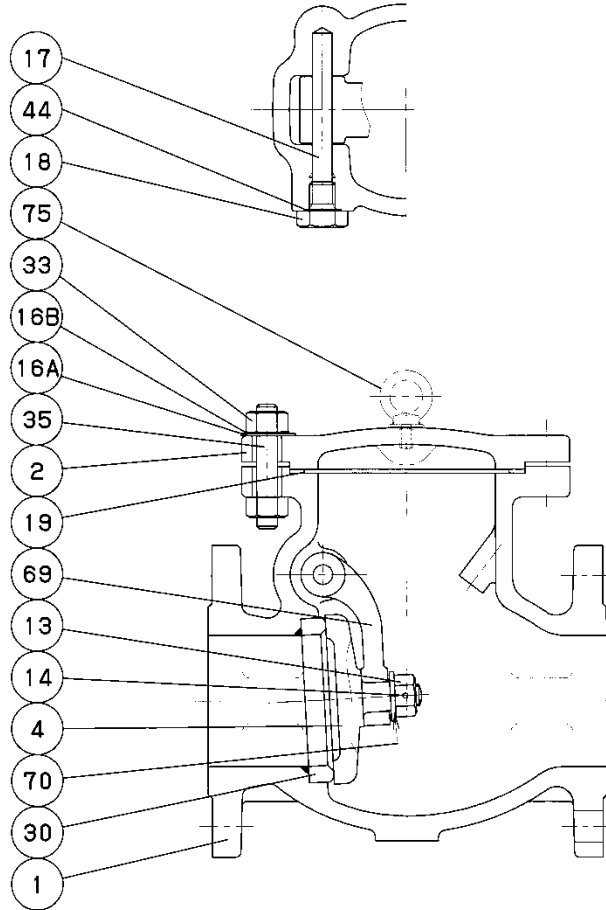

No.	Parts Name
1	Body
2	Cover
4	Disc
13	Disc Nut
14	Split Pin
16A	Name Plate
16B	Washer
17	Hinge Pin
18	Plug
19	Gasket
30	Body Seat Ring
33	Cover Nut
35	Cover Bolt
44	Gasket
69	Arm
70	Washer
75	Eye Bolt

This illustration introduces a typical construction.
 Refer to the approval drawing before disassembly and assembly.

3.3.2 Plug without check valve

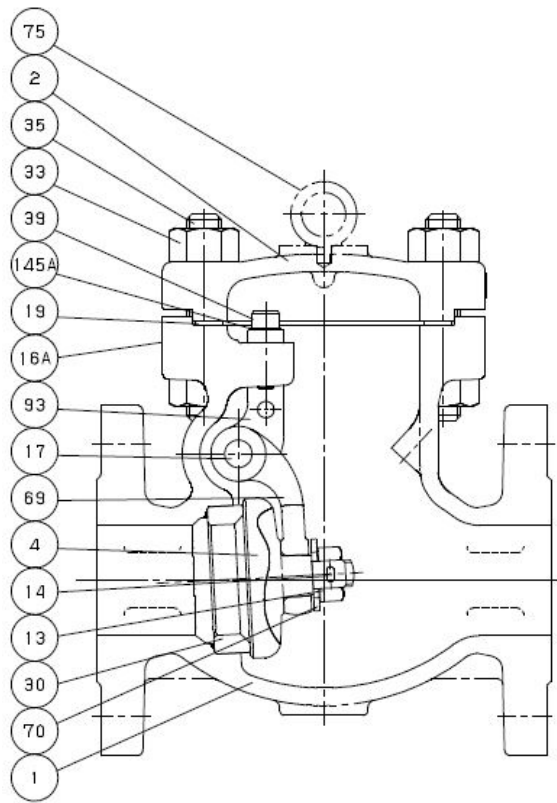

No.	Parts Name
1	Body
2	Cover
4	Disc
13	Disc Nut
14	Split Pin
16A	Name Plate
17	Hinge Pin
19	Gasket
30	Body Seat Ring
33	Cover Nut
35	Cover Bolt
39	Bolt
69	Arm
70	Washer
75	Eye Bolt
93	Hinge Pin Holder
145A	Bolt stopper

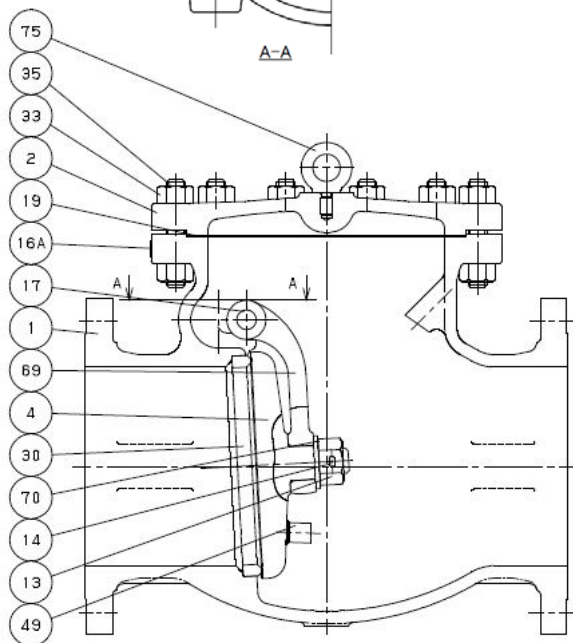
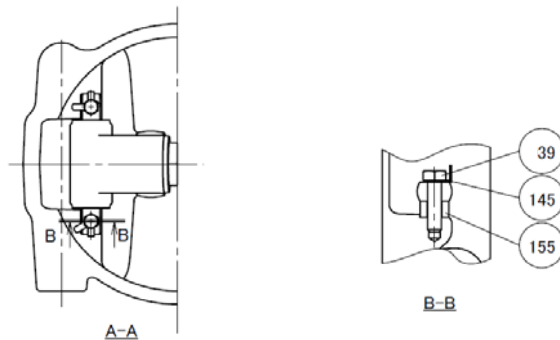

No.	Parts Name
1	Body
2	Cover
4	Disc
13	Disc Nut
14	Split Pin
16A	Name Plate
17	Hinge Pin
19	Gasket
30	Body Seat Ring
33	Cover Nut
35	Cover Bolt
39	Bolt
49	Stopper
69	Arm
70	Washer
75	Eye Bolt
145	Bolt stopper
155	Spacer



This illustration introduces a typical construction.
 Refer to the approval drawing before disassembly and assembly.



VII Disassembly and Assembly

4. Lift Check Valves

4.1 Disassembly

4.1.1 Cautions for safety

 WARNING	
	<ul style="list-style-type: none">● Operators must take protective measures to prevent direct exposure to the fluid, when the fluid spouts out from valves.

 CAUTION	
	<ul style="list-style-type: none">● Wear protective items such as goggles, gloves and working boots.● Take care not to catch fingers in flanges during disassembly.

4.1.2 Before disassembly

- (1) Disassemble the valve in a dust-free place.
- (2) Take care not to damage the seat surfaces and flange surfaces.
- (3) Matchmark the body and cover flange for easy assembly.

4.1.3 Disassembly



Note: see sheet 59/60 for reference figure.

- (1) Remove the cover nuts.
- (2) Remove the cover.
- (3) Remove the gasket.
- (4) Remove the disc from inside of body.

VII Disassembly and Assembly

4.2 Assembly

4.2.1 Caution for safety

 CAUTION	
	<ul style="list-style-type: none"> ● Wear protective items such as goggles, gloves and working boots. ● No fire should be allowed in working area. ● Take care not to catch fingers in flanges during assembly. ● Replace the gasket with new ones to ensure satisfactory sealing performance.
	<ul style="list-style-type: none"> ● Do not apply lubricants to the pipes and valves which handle oxygen.

4.2.2 Before assembly

- (1) The consumables should be prepared before assembly.
- (2) Clean parts to remove dust and other foreign objects.
- (3) Assemble the valve in a dust-free place.
- (4) Take care not to damage the seat surfaces and flange surfaces.
- (5) Assemble the valve aligning the matchmarks provided before disassembly.
- (6) All bolts and nuts should be tightened securely.

VII Disassembly and Assembly

4.2.3 Assembly

Note: see sheet 59/60 for reference figure.

- (1) Place the disc inside the body.
Make sure the disc seated on the body seat perfectly.
- (2) Mount the gasket on the cover flange.
- (3) Assemble the cover with the body aligning the matchmarks provided before disassembly.
- (4) Tighten cover bolts and nuts evenly, gradually and alternately on the diagonal line. The end of each tightened bolt should protrude equally beyond the nut.
- (5) Check each threaded portion. Retighten them, if found loosened.

VII Disassembly and Assembly

4.3 Assembly Illustration

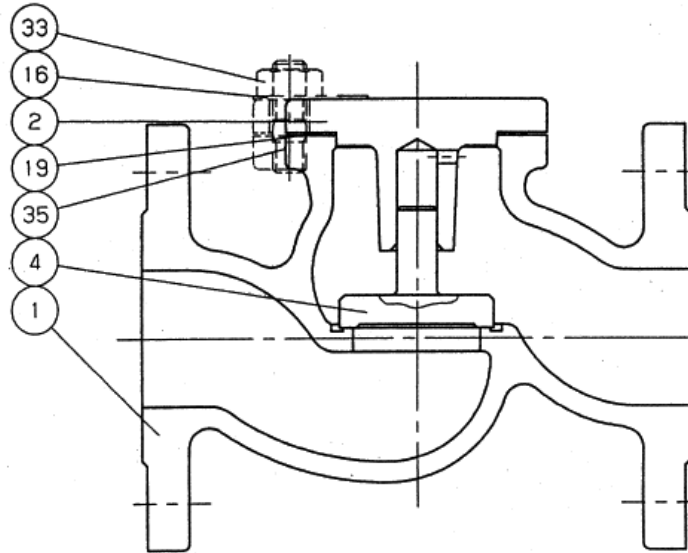

No.	Parts Name
1	Body
2	Cover
4	Disc
16	Name Plate
19	Gasket
33	Cover Nut
35	Cover Bolt

This illustration introduces a typical construction.
 Refer to the approval drawing before disassembly and assembly.