

Climate
Control

IMI TA

EMO T II

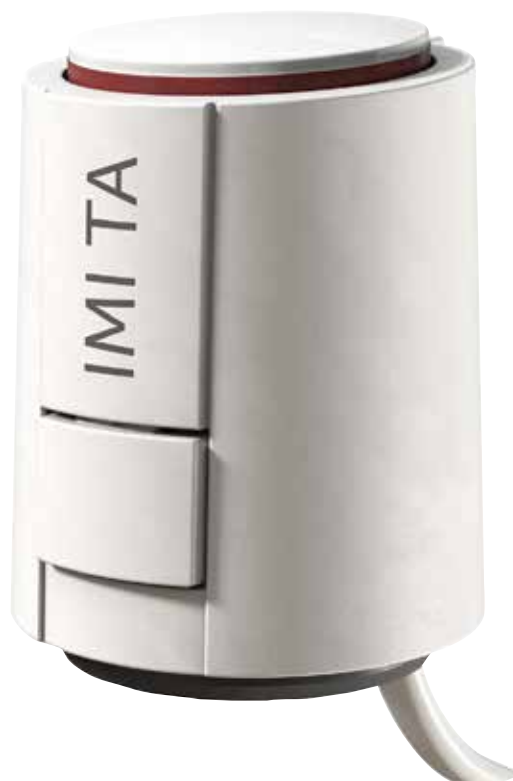

Actuators

High performance thermoelectric actuator –
For ON/OFF or PWM control

EMO T II

Used in conjunction with small terminal valves e.g. TBV-C and TA-Nano, the high performing EMO T II actuator offers reliable on/off control and a high enclosure class. The position indicator is visible from all sides and allows easy maintenance procedures. The snap-on and First-open functions facilitate the installation and commissioning of the EMO T II.



Key features

High adjusting force and high reliability

Tested in conjunction with all of IMI valves up to 150 000 cycles.

High enclosure class IP54

For secure operations at any installation positions.

Position indicator visible from all sides

For straightforward maintenance.

Low power consumption

For reduced energy consumption and easy power supply dimensioning.

M30x1.5 snap-on ring

Facilitating installation of actuator on valve thread.

Technical description

Applications:

Designed for ON/OFF or PWM control.

Supply voltage:

24 VAC/VDC +25% / -20%
230 VAC ±10%
120 VAC ±10%
Frequency 50-60 Hz

Power consumption:

24 V:
During operation ≤ 1 W (VA)
Starting current ≤ 300 mA during max. 2 min.
230 V / 120 V:
During operation ≤ 1 W (VA)
Starting current ≤ 550 mA during max. 100 ms.

Operating cycle time:

~ 4 min when starting from cold.

Adjusting force:

100 N +10%

Stroke:

5 mm
Valve position visible due to position indicator.

Temperature:

Max. ambient temperature: 60°C
Min. ambient temperature: 0°C
Max. medium temperature: 100°C
Storage temperature: -25°C to +60°C

Ingress protection:

IP54 at any position.

Protection class:

III, EN 60730

Certification:

CE, EN 60730-2-14

Cable:

Cable length: 1 m, 2 m or 5 m.
For longer cable – see “Articles – Without premounted cable”.
Connection cable: 2 x 0,75 mm².
The cable is stripped 100 mm and each wire is stripped 8 mm.
Halogen free as option, fire class B2_{ca} – s1a, d1, a1 according to EN 50575.

Connection to valve:

M30x1,5 plastic snap-on ring.

Body:

Shock-resistant Polyamide, white RAL 9016.

Function

First-Open function (NC model)

In delivery status, the First-Open function allows the NC actuator to keep the valve open without current. This simplifies actuator installation by removing the need to press it onto the valve stem. This enables heating operation during the construction phase even when the electric wiring of the room-by-room temperature control system is not yet complete. During subsequent commissioning, applying the operating voltage (> 6 min. at 230/120 V and > 9 min. at 24/12 V) automatically unlocks the First-Open function and the actuator is fully functional.

Closed when currentless (NC model)

Initiating operating voltage heats up the expansion system of the actuator. After the time lag, a uniform opening process ensues. If the voltage is cutoff, the actuator closes via the cooling of the expansion system after the time lag.

Open when currentless (NO model)

Initiating operating voltage heats up the expansion system of the actuator. After the time lag, a uniform closing process ensues. If the voltage is cutoff, the actuator opens via the cooling of the expansion system after the time lag.

Note:

When conducting a performance test, be sure to check the time response (time lag)!
Opening and closing times are dependent on the ambient temperature.

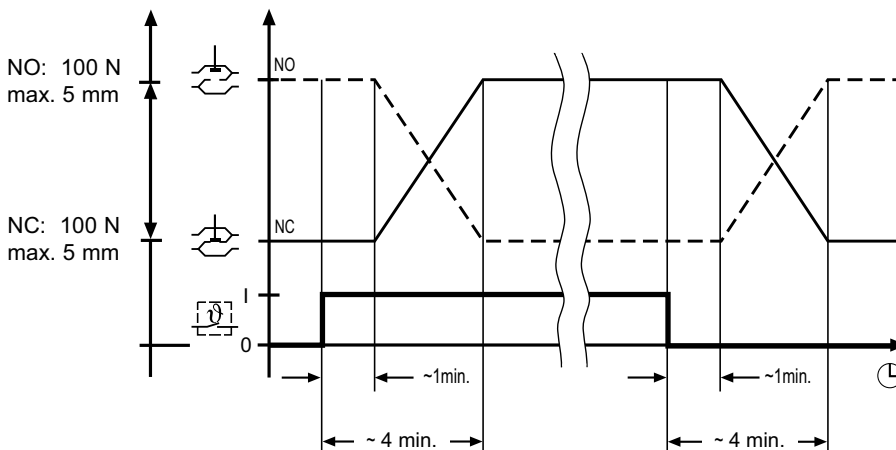

Working range

The actuator is designed to suit recommended IMI TA valves with M30x1,5 connection to actuator. The actuator has a working range corresponding to X = 11,0 mm - 16,0 mm.



Installation

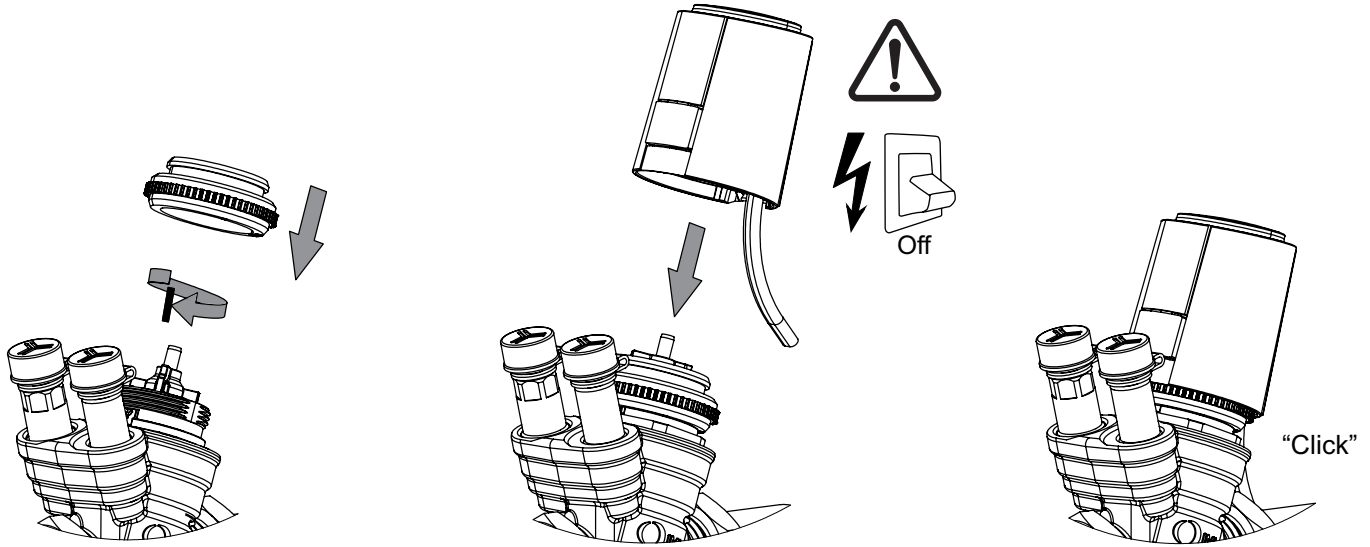

Enclosure class:

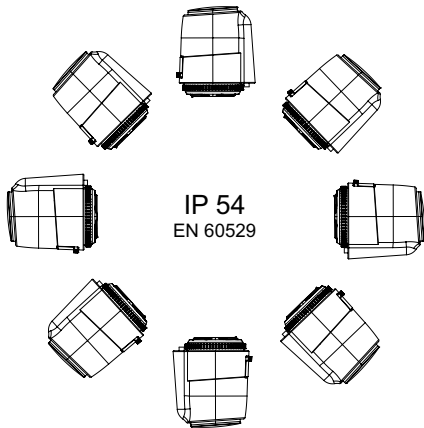

Connection diagram

N L — 230 VAC (120 VAC) (+15%/- 15%); nom. 1 W

~ ~ — 24 VAC/VDC (+25%/- 20%); nom. 1 W

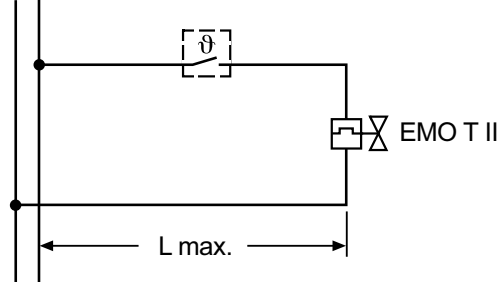

(L max. see planning notes)

Planning notes

24 V transformer dimensioning

For operation with 24 V low voltage, a transformer is required which is in compliance with EN 60335 and possesses sufficient capacity.

For dimensioning transformer power, the value for the starting phase needs to be taken into account. The same applies to the layout of switching contacts of room temperature controllers.

Minimum transformer power delivery results from:

The sum of the take-up of the 24 V EMO T II (in the starting phase) in addition to the sum of the take-up capacities of the room thermostat.

24 V protective low voltage

With the required protective low voltage (SELV based on DIN VDE 0100) a safety isolating transformer in compliance with EN 61558-2-16 must be used.

Length of cable

In order to maintain the declared opening times for the actuators, the voltage loss (depending on length of cable and cross section) in the operating phase on the supply lines to the actuators may not exceed 4%.

For general dimensioning with copper lines, use the following standard formula:

$$L \text{ max.} = I / n$$

L max.: max. length of cable in [m] (see "Connection diagram")

I: table value in [m]

n: number of actuators

Line: Type/name	Cross section: A [mm ²]	I		Note: Application; comparison
		230 V (120 V) [m]	24 V [m]	
J-Y(ST)Y	0,8	-	45	only for 24 V
NYM / NYIF	1,5	-	136	only for 24 V

Calculation example

Goal:

max. length of cable L max.

Given:

Voltage U = 24 V

Conductor cross section A = 2 x 1.5 mm²

Value in table I = 136 m

Number of actuators n = 4

Solution:

$$I \text{ max.} = I / n = 136 \text{ m} / 4 = 34 \text{ m}$$

Articles – With premounted cable

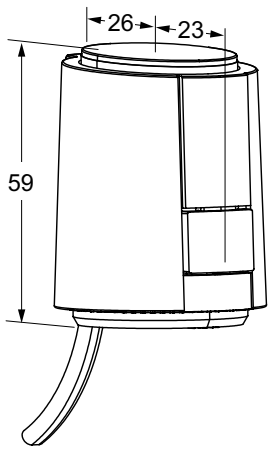

EMO T II – 24 VAC/VDC

Including snap-on ring.

Cable length [m]	EAN	Article No
NO (Normally open)		
1	5902276824982	322043-11011
2	5902276824999	322043-11012
5	5902276825002	322043-11013
NO (Normally open) - With halogen free cable		
1	5902276825019	322043-11021
2	5902276825026	322043-11022
NC (Normally closed)		
1	5902276825040	322043-11111
2	5902276825057	322043-11112
5	5902276825064	322043-11113
NC (Normally closed) - With halogen free cable		
1	5902276825071	322043-11121
2	5902276825088	322043-11122

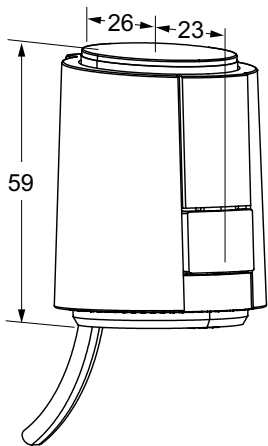

EMO T II – 230 VAC

Including snap-on ring.

Cable length [m]	EAN	Article No
NO (Normally open)		
1	5902276825118	322043-12011
2	5902276825125	322043-12012
5	5902276825132	322043-12013
NO (Normally open) - With halogen free cable		
1	5902276825149	322043-12021
2	5902276825156	322043-12022
NC (Normally closed)		
1	5902276825170	322043-12111
2	5902276825187	322043-12112
5	5902276825194	322043-12113
NC (Normally closed) - With halogen free cable		
1	5902276825200	322043-12121
2	5902276825217	322043-12122

EMO T II – 120 VAC

Including snap-on ring.

Cable length [m]	EAN	Article No
NC (Normally closed)		
1	5902276825231	322043-13111

Articles – Without premounted cable

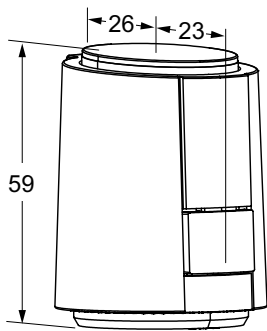

EMO T II – 24 VAC/VDC
Including snap-on ring.

	EAN	Article No
NO (Normally open)	5902276824975	322043-11000
NC (Normally closed)	5902276825033	322043-11100

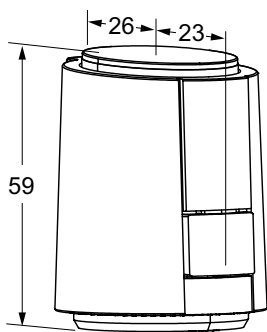

EMO T II – 230 VAC
Including snap-on ring.

	EAN	Article No
NO (Normally open)	5902276825101	322043-12000
NC (Normally closed)	5902276825163	322043-12100

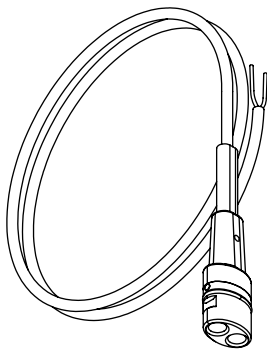

Cables

Cable length [m]	EAN	Article No
PVC		
1	5902276825309	322042-12001
2	5902276825316	322042-12002
5	5902276825323	322042-12003
10	5902276825330	322042-12004
Halogen free		
1	5902276825347	322042-12011
2	5902276825354	322042-12012
5	5902276825361	322042-12013
10	5902276825378	322042-12014



The products, texts, photographs, graphics and diagrams in this document may be subject to alteration by IMI without prior notice or reasons being given. For the most up to date information about our products and specifications, please visit climatecontrol.imiplc.com.