

TML

TML Pam E-3001C

PORTABLE DATA LOGGER **TDS-150**



- | | | | | | |
|----------------------|---------------------------------|-------------------|---------------------|---------------|---|
| <p>Strain Gauges</p> | <p>Strain Gauge-transducers</p> | <p>DC voltage</p> | <p>Thermocouple</p> | <p>Pt RTD</p> | <p>FSW-10
Channel unit
Max 50CH</p> |
|----------------------|---------------------------------|-------------------|---------------------|---------------|---|



Tokyo Sokki Kenkyujo Co., Ltd.

RESEARCH EQUIPMENT CO.,LTD.

Field use, battery drive

This portable data logger consists of a control unit (TDS-150) and exclusive decade channel units (FSW-10) and measures strain gauges, strain-gauge-based transducers, DC voltages, thermocouples and Pt RTD. The decade channel unit (FSW-10) can be cascaded up to 5 units to total 50 channels. In addition, by using a switching box/TML-NET driving board (option), up to 100 channels can be extended. TDS-150 operates on not only AC mains but alkaline D-cells or battery and has data memory and sleep interval timer functions for long term automatic measurement. It is possible to store measurement data and setup condition on compact flash memory card. Interfaces are USB and RS-232C, and reading of various setting conditions and measurement data can be conducted from a PC.

FUNCTIONS

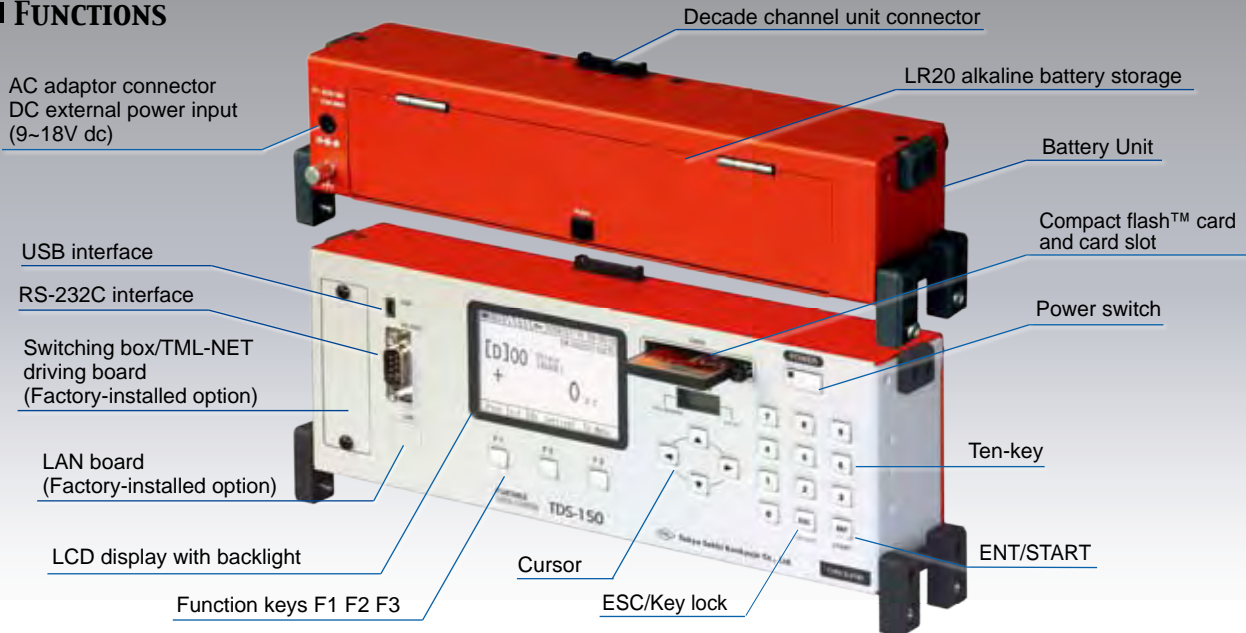

FEATURES

- Connectable Five decade channel units (FSW-10) for 50 channels max.
- Possible long-term automatic measurement using sleep interval timer.
- Low power consumption
- Measurement of strain, DC voltage and temperature using thermocouples and Pt RTD.
- Large capacity data memory available.
- 1-gauge 4-wire method available.
- TEDS compatible
- Strain complete compensation method available
- Connectable network modules (Factory installed option)

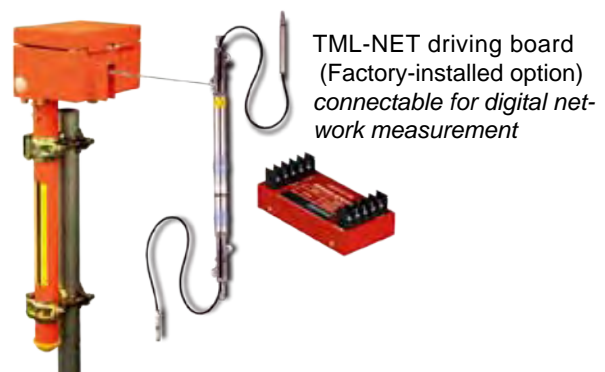

System block diagram

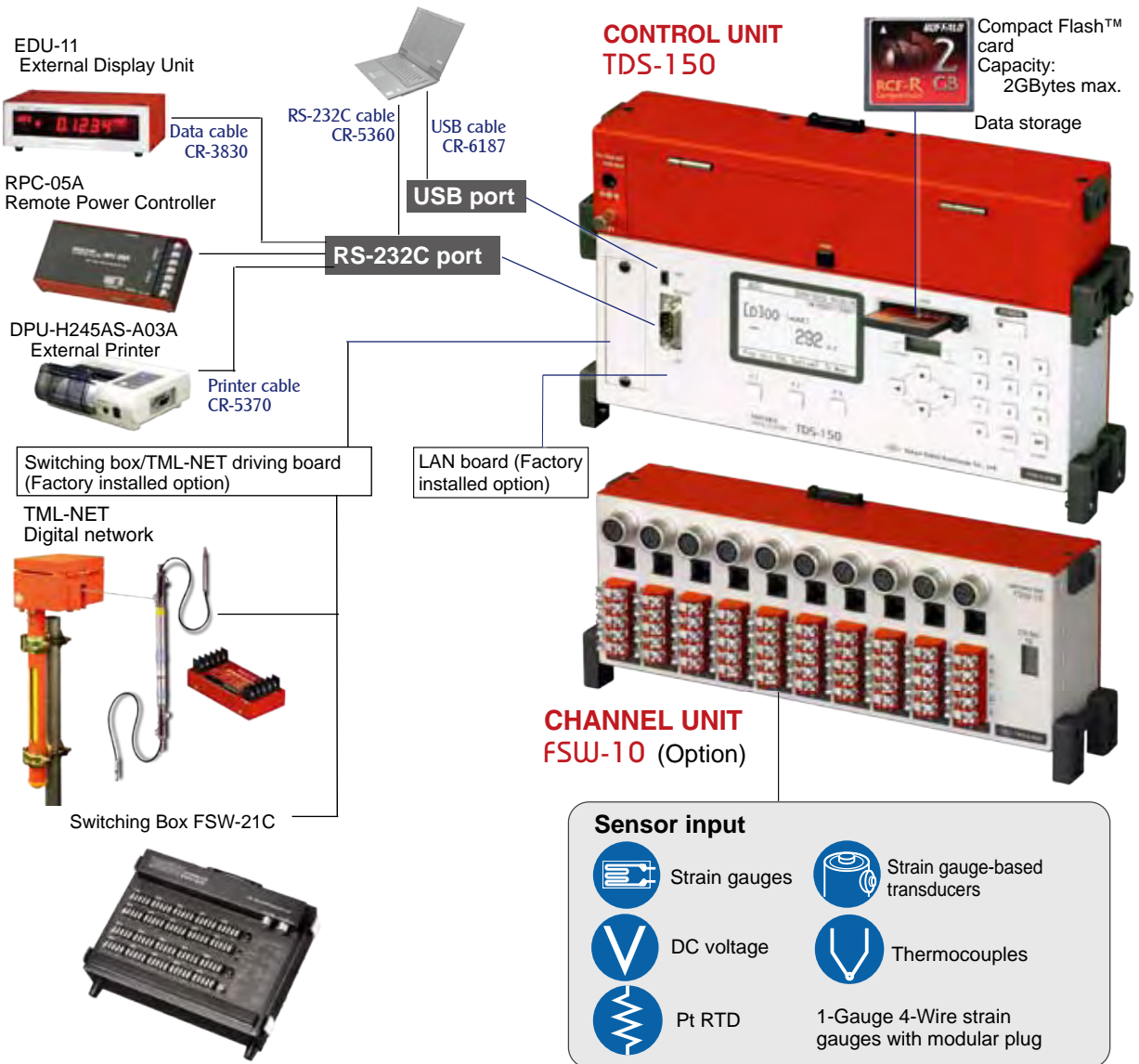

INTERFACE

USB port

Using the USB cable CR-6187 (option), control of TDS-150 from a computer and data read of online measurement are possible. The USB driver is contained in TML measurement software Visual LOG Light (option).

RS-232C port

By connecting the RS-232C cable CR-5360 (option), control of TDS-150 from a computer and data read of online measurement can be done. Also, connection with external devices using the external cable is possible.

- **Monitoring on TML External Display EDU-11**
The use of EDU-11 enables monitoring at a place away from TDS-150.
- **Measurement with Remote Power Controller RPC-05A**
By setting up RPC-05A between TDS-150 and a computer or modems, power on/off, control for solar power charge, etc. in long-term measurement are possible.
- **Printout of data**
The measured data and stored data are printed on the external printer DPU-H245AS-A03A (option).

DATA MEMORY

The maximum 80,000 data can be recorded. The data memory is one area only and the data stored in the area in order of measurement. One data are composed of channel, measurement time, measured data and physical unit.

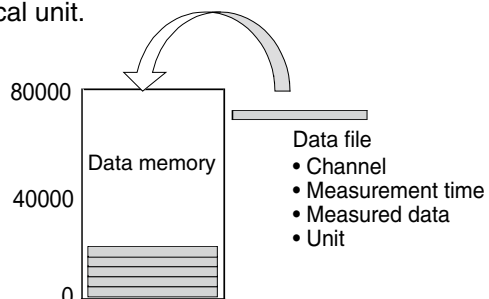

- The number of recordable data is 80,000 maximum.
- When the number of data reaches 80,000, M is indicated on the Sub-LCD and no more data recorded.
- Even if the channel is changed the storing destination of the data is not changed.
- The data after storing in a PC should be sorted out by channel.

Pop-up operation guide

[Proc Init]
Initial value processing

```

** Process of initial value **
1. Initial in
2. initial in of monitor channel
3. Rewriting of initial value
    
```

[Ch. Setting]
Monitor channels set

[D]00	+	322	kgf
[D]01	+	120.90	mm
[D]02	+	805	N
[D]03	+	48	°C
[D]04	+	242	μ ε

[To Menu]

```

2009/10/02 16:15:12
** menu **
1. Program
2. Measure/Direct mode
3. Auto measurement
4. Various checks
5. Check on Network module
6. Memory
    
```

Initial-in functions to take initial unbalanced value of the strain gauge or transducer from measurement value.

Selectable display for numerical value Y-T waveform, or OFF.

Applicable sensor

	Strain gauges	<pre> ** Sensor mode list ** 1G3W 120Ω 2GAGE 1G3W 240Ω 2GAGE Common 1G3W 350Ω 4GAGE 1G4W 120Ω 4G C350Ω 1G4W 240Ω 4G 0-2V 1G4W 350Ω JUMP </pre>		Thermo-couples	<pre> T.C. T(CC) T.C. E(CRC) T.C. K(CA) T.C. N T.C. J(IC) DC 300mV T.C. B DC 30V T.C. S Pt100 3W T.C. R TML-NET </pre>	
	Strain gauge transducers			Pt RTD		
	TEDS compatible sensor		<pre> ** TEDS sensor Info reading ** Ch Cap Unit R.O. 00 +1.0000E+5 N 3000μ ε 01 +0.0000E+0 0μ ε 02 +0.0000E+0 0μ ε 03 +0.0000E+0 0μ ε 04 +0.0000E+0 0μ ε </pre>			DC voltage
				TML-NET Digital network module		
				Previous Next		
		Previous Next				

Various checks

```

** Various checks **
1. Insulation check
2. Dispersion check
3. Burn out check
4. Lead wire resistance check
5. Bridge output check
6. Coefficient check
    
```

```

** Lead wire resistance check **
Head Ch Measurement data unit
[r] 00 - 2518 μ V
    
```

```

** Bridge output check **
Head Ch Bridge output unit
[e] 00 + 70 μ V
    
```

Resistance check of leadwire on the 3-wire quarter bridge mode in COMET function.

Bridge output voltage check on the 3-wire quarter bridge

Data record

```

** Memory **
1. Data memory
2. CF card
3. Copying the file
4. Record on data memory, CF card
    
```

File and data managements
Reading/Deletion of data memory
File dump, Card format, etc. of CF card
File copy of specified file name
Record of measured data in data memory, CF, and both

Interface

```

** Interface **
1. RS-232C
2. LAN
3. Data output
4. Data format
5. Parameter of external display
    
```

RS-232C : Baud rate/Data bit/Parity/Stop bit, etc.
LAN : Factory installed option
Data output through the RS-232C port to a printer, display unit or PC
Data format : Setting of data format with TDS/CSV and display of header, and time

Various applications

1-Gauge 4-Wire strain measurement method Patented

Our developed method makes strain measurement possible by plugging strain gauges with lead wires in 4-wire system and modular plug in the input receptacles of the FSW-10.

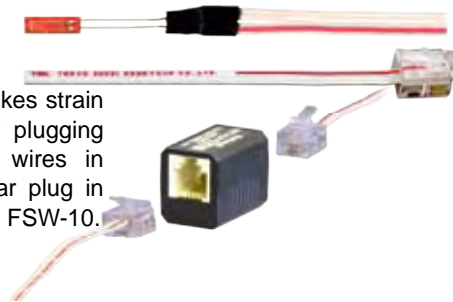

TML-NET for 2-wire digital network measurement

Strain gauge-based transducers : Load cells, Displacement transducers
Civil engineering transducers, etc.
and DC voltage, Thermocouples

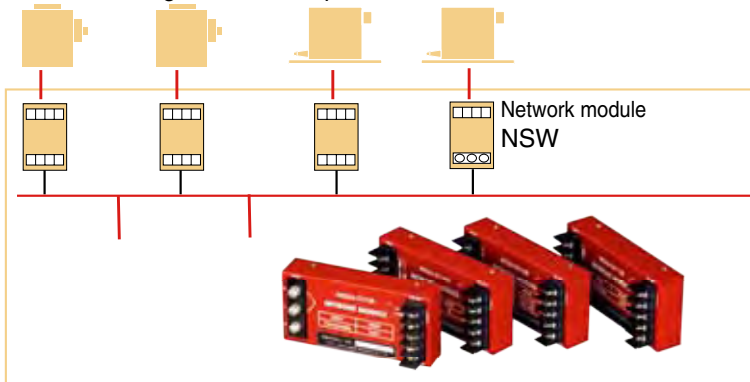

Switching box/TML-NET driving board
(Factory-installed option)

Free combination



Compact design enabling to store in any storage box



Number of channels

Maximum 100 channels	In conjunction with external switching box NB: Switching box/TML-NET driving board (Factory-installed option) is required.
50 channels	In conjunction with 5 units of FSW-10

Applicable sensors (Sensor mode setting)

Strain	1-gauge 4-wire method	120Ω 240Ω 350Ω	Bridge excitation voltage DC1V 48ms (50Hz)
	3-wire quarter bridge	120Ω 240Ω 350Ω	
	Half bridge	120~1000Ω	
	Full bridge	120~1000Ω	
	Full bridge constant current	350Ω	
	Full bridge 0-2V	120~1000Ω	
Thermo-couple	Thermocouple T	Linearization: Digital operation	
	Thermocouple K		
	Thermocouple J		
	Thermocouple B		
	Thermocouple S		
	Thermocouple R		
	Thermocouple E		
Thermocouple N			
DC voltage	Voltage V 1/1	±300mV	Input impedance V 1/1 more than 500MΩ V 1/100 more than 1MΩ
	Voltage V 1/100	±30V	
Pt RTD	Pt RTD 3-wire		Linearization: Digital operation
TML-NET	Operating NSW series [Option]		Data reading from Network sensors

Measuring Range

Item	Range	Measuring range	Initial memory	Sampling speed
Strain	x1	±30000 x10 ⁻⁶ strain	±160000 x10 ⁻⁶ strain	80ms (50Hz area) 67ms (60Hz area)
	x10	±300000 x10 ⁻⁶ strain	±1600000 x10 ⁻⁶ strain	
DC voltage	x1	V 1/1 ± 30.000mV	V 1/1 ±160.000mV	
	x10	±300.000mV	±1600.000mV	
	x1	V 1/100 ± 3.0000 V	V 1/100 ± 16.0000V	
Thermo-couple	—	T: - 250 ~ + 400°C	—	
		K: - 210 ~ +1370°C		
		J: - 200 ~ +1200°C		
		B: +200 ~ +1760°C		
		S: - 10 ~ +1760°C		
		R: - 10 ~ +1760°C		
		E: - 210 ~ +1000°C		
N: - 200 ~ +1300°C				
Pt RTD	—	- 200 ~ +850°C	—	

Note : Measuring range in Full bridge 0-2V mode for TML LVDT is ±15000 x10⁻⁶ strain (x1) and 150000 x10⁻⁶ strain (x10).

Measuring accuracy

Sensor mode	Range	Resolution	Accuracy (23°C±5°C)	Temperature effect (%rdg/°C)	Aging effect (%rdg/year)
Strain	x1	1x10 ⁻⁶	±(0.08%rdg+1digit)	±0.002	±0.02
	x10	10x10 ⁻⁶	±(0.08%rdg+1digit)	±0.002	±0.02
DC voltage V1/1	x1	0.001mV	±(0.08%rdg+3digit)	±0.0024	±0.02
	x10	0.010mV	±(0.08%rdg+3digit)	±0.0024	±0.02
DC voltage V 1/100	x1	0.0001V	±(0.08%rdg+2digit)	±0.002	±0.02
	x10	0.0010V	±(0.08%rdg+2digit)	±0.002	±0.02
Pt RTD Pt100 3W	—	0.1°C	±(0.08%rdg+3°C)	±0.0020	±0.05

Range : in auto-ranging

Leadwire resistance correction

Comet B (3-wire quarter bridge)	Gauge resistance	Leadwire resistance correction range
	120Ω	Less than 100Ω
	240Ω	Less than 200Ω
	350Ω	Less than 300Ω

Thermocouple temperature measurement

Thermo-couple	Measuring range (°C)	Resolution (°C)	Accuracy ±(%rdg+°C) (23°C±5°C)	
			External RJC	Internal RJC
T	- 250 ~ - 200	0.1	0.38 + 0.6	0.38 + 3.9
	- 200 ~ - 100	0.1	0.15 + 0.2	0.15 + 1.4
	- 100 ~ + 400	0.1	0.10 + 0.2	0.10 + 0.8
K	- 210 ~ - 160	0.1	0.19 + 0.3	0.19 + 1.6
	- 160 ~ 0	0.1	0.12 + 0.2	0.12 + 1.0
	0 ~ + 960	0.1	0.08 + 0.1	0.08 + 0.5
	+ 960 ~ +1370	0.1	0.10 + 0.9	0.10 + 1.4
J	- 200 ~ - 160	0.1	0.16 + 0.2	0.16 + 1.2
	- 160 ~ 0	0.1	0.12 + 0.1	0.12 + 0.8
	0 ~ + 700	0.1	0.08 + 0.1	0.08 + 0.5
	+ 700 ~ +1200	0.1	0.08 + 0.6	0.08 + 0.9
B	+ 200 ~ + 280	0.5-0.4	0.04 + 4.0	0.04 + 4.0
	+ 280 ~ + 800	0.3-0.1	0.04 + 1.2	0.04 + 1.2
	+ 800 ~ +1760	0.1	0.05 + 0.4	0.05 + 0.4
S	- 10 ~ + 200	0.1	0.09 + 0.6	0.09 + 1.2
	+ 200 ~ +1760	0.1	0.07 + 0.4	0.07 + 0.7
R	- 10 ~ + 150	0.1	0.09 + 0.7	0.09 + 1.2
	+ 150 ~ +1760	0.1	0.07 + 0.4	0.07 + 0.7
E	- 210 ~ + 550	0.1	0.17 + 0.2	0.17 + 1.4
	+ 550 ~ +1000	0.1	0.09 + 0.4	0.09 + 0.8
N	- 200 ~ 0	0.1	0.18 + 0.4	0.18 + 1.6
	0 ~ +1090	0.1	0.08 + 0.2	0.08 + 0.6
	+1090 ~ +1300	0.1	0.08 + 0.9	0.08 + 1.2

The accuracy of thermocouples is not included. Thermocouple B does not use RJC. RJC: Reference junction compensation

Display	Display unit	LCD with backlight
	Resolution	255x160 dot
	Contents	Measuring data, Setting list, Y-T monitor
Clock	Setting	Year, Month, Day, Hour, Min. and Sec.
	Accuracy	±1 sec./day (23°C±5°C)
Interface	USB/RS-232C, LAN (Option)	
	Function	Control from PC and Data transfer
Measurement mode	INITIAL, DIRECT & MEASURE for each channel (DIRECT only for temperature)	
Channel switching	Scanning	Automatically from First to Last channel (Jump available)
	Monitor	Repetition of monitor channel Time-independent graphic monitor
Measurement start	Start key switch, Interval timer, Monitor comparator USB, RS-232C and LAN (Option)	
Program	Capable of setting for each channel	
	Coefficient	±(0.0001 to 99999)
	Unit	40 kinds such as με, mV, °C, kN and mm
	Decimal point	Any 0 ~ 6 decimal places
	Initial value	Writing for every channel
	Sensor mode	Setting for every sensor
SIMPLE measure	Coefficient	1.0000
	Unit	As per sensor mode
	Decimal point	As per sensor mode
Self-diagnosis	Insulation resistance, Dispersion, Sensitivity, Thermocouple wire burnout, Bridge output and coefficient setting	
TEDS	Standard Function	IEEE1451.4 Class 2 Readout of TEDS sensor parameter
	Function	Automatic start according to the set time interval and time
Interval timer	Interval	Hour, min. and sec. up to 99h 59m 59s for each step
	No. of starts	Programmable 99 times at max. or infinite per step
	No. of steps	Programmable 10 steps at max.
	Real time start	Sets a start time (day: hour: minute: second) for each step
	GOTO step	Looping previous step
	Sleep ON/OFF	Switches on 5 sec. before measurement start and turns off automatically after measurement finish
	Monitor comparator	Function
Comparative amount		Amount settable every step (±999999 at max.)

Monitor comparator	Comparative method	Available either amount of change or absolute
	Cycles of start	Max. 99 times/step or infinite
	Cycles of step	Max. 10 steps programmable
	GOTO step	Programmable loop to previous step
	GOTO interval	Move to step 1 of interval
Data memory	Function	Storing and reading of measurement data
	Contents	Measure mode, channel number, measurement data, time data and data number
	Capacity	Maximum 80000 data or 16,000 scans per 10 channels
	Storage period	About 20 days (with full charge)
Memory card	Standard	Compact Flash™ card
	Capacity	32MB ~ 2GB (FAT 16)
Auto-power OFF	Automatically turns off when neither receiving any key operation nor interface commands for any set time. Switchable On/ Off.	
Operational time in continuous use	Using 4 LR20 alkaline battery Full bridge 120Ω about 40 hours at 23°C±5°C 1 hour sleep interval about 8 months for 10 channels scanning, Sleep ON at 23°C±5°C	

Operational environment	-10 ~ +50°C <85%RH without condensation
Storing temperature	-20 ~ +60°C
Power requirement	LR20 Alkaline cell 4 pieces Exclusive AC adaptor (CR-1861) External battery 9 ~ 18Vdc
Dimensions	TDS-150 Control unit including battery unit 280(W) x 60(H) x 162(D) mm FSW-10 Unit channel (Option) 280(W) x 60(H) x 100(D) mm excluding projecting parts
Weight	TDS-150 Control unit : 1.0 kg Battery unit : 0.6 kgs (No battery installed) FSW-10 Unit channel (Option) : 1.5 kgs.

Standard accessory

LR20 Alkaline cell	4 pieces
Philips driver	1 piece
Operation manual	1 copy
Carrying belt	1 piece

Outer View and Dimensional Diagram

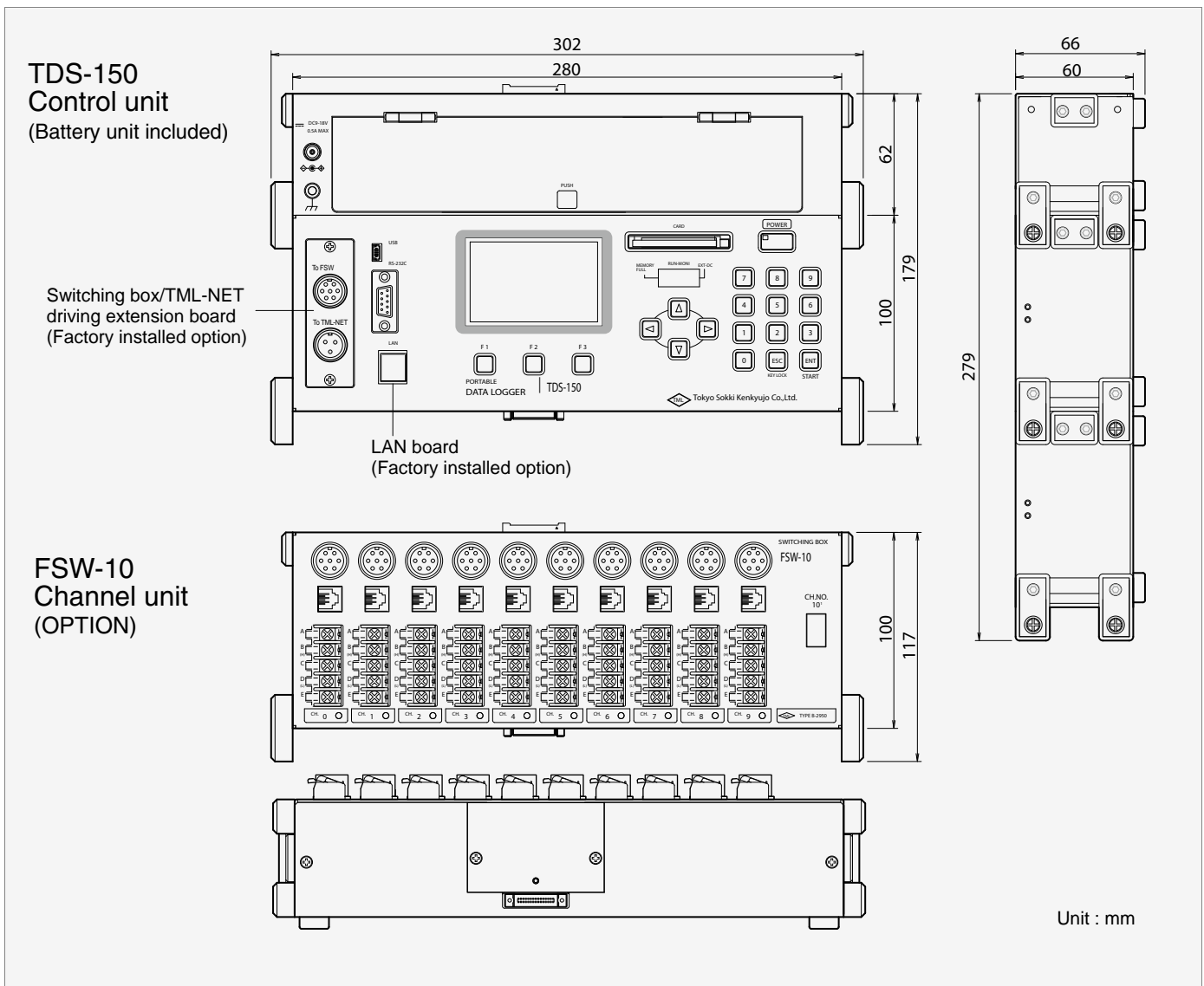

Channel Unit FSW-10

Combination with the exclusive switching box makes maximum 50 channels automatic and interval measurement possible.



External Printer DPU-H245AS-A03A

The measurement data of TDS-150 is printed out..



Printer cable CR-5370 optional
Dsub9P-10P(mini) thru 0.5m
Exclusive cable

Remote Power Controller RPC-05A

In combination with RPC-05A and an external battery, long-term measurement with TDS-150 using sleeping function becomes possible.



RS-232C cable CR-5360

Dsub9P-9P Cross
Exclusive cable for connection with personal computer

USB cable CR-6187

Mini B-A with ferrite core 1.5m
Exclusive cable for connection with personal computer

AC adaptor CR-1861

Compact Flash™ card

Capacity : 32MB-2GB



External Display Unit EDU-11

The monitor value of TDS-150 can be displayed at a remote place. Features high visibility with high-brightness LED.

Data cable CR-3830
BNC output cable
CR-31 belonging to
EDU-11



TEDS compatible sensor

To use TEDS function of the TDS-150, TEDS compatible sensor is required to recognize its own parameters such as measuring capacity, rated output, etc. registered in the built-in IC chip.

TEDS compatible load cell
TCLZ with the built-in IC chip



1-Gauge 4-Wire method Strain Gauges

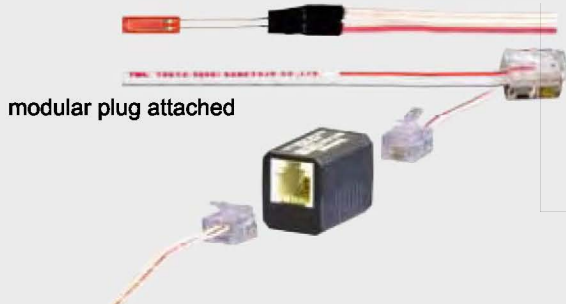

Specifications subject to change without prior notice



Approval Certificate ISO9001
Design and manufacture of
strain gauges, strain measuring
equipment and transducers



Tokyo Sokki Kenkyujo Co., Ltd.
www.tml.jp/e

8-2, Minami-Ohi 6-Chome, Shinagawa-Ku, TOKYO 140-8560, JAPAN
TEL: TOKYO 03-3763-5611 FAX: TOKYO 03-3763-5713
e-mail address:sales@tml.jp