

HANDHELD DATA LOGGER **TC-32K**

- Strain Gauges
- Strain gauge transducers
- DC Voltage
- Thermocouples
- Pt RTD
- CSW-5B for multiple measurement



LCD screen with backlight

Interface USB RS-232C



Switching Box CSW-5B



Pop-up menu



Alkaline battery drive supported



1-Gauge 4-Wire strain measurement

CF card saving



HANDHELD DATA LOGGER

TC-32K



TC-32K is a compact and handheld digital data logger. The splash-waterproof construction enables outdoor use. The sensor connection terminal board is a patented one-touch type to facilitate connection with leadwires and banana plug and speedy preparation for measurement. Sensor mode, coefficient and initial values can be set and measurement values recorded for the maximum 20 channels, so you can collect measurement data at several field sites for later data processing. The use of the exclusive switching box CSW-5B makes 5-channel automatic measurement possible. TC-32K has an interval timer, data memory, CF memory card slot and interfaces for computer control and data transfer. Gauge resistance and insulation resistance measurement functions are also provided to easily check strain gauges and transducers.

High brightness LCD and display in selectable measurement mode switch



LCD with backlight
Resolution 255x160 dots

Easy operability and high reliability

Keeping in touch with multi-measurement of strain, DC voltage, thermocouple, PtRTD, etc.

 Strain gauges	 Strain gauge-type transducers	 Thermocouples
 DV voltage	 Load cells, Displacement transducers, etc.	 Pt RTD

Through TEDS compatible sensor, automatically recognizes measurement range, rated output, etc.

One-touch connection with TEDS compatible load cell.

To use TEDS function, a transducer supporting TEDS is required.

1-Gauge 4-Wire strain measurement available

Optional adaptor CR-5810 offers 1-Gauge 4-Wire measurement (patent) with connection by modular plug, enabling ideal measurement without sensitivity drop and temperature effect due to leadwires.

1-Gauge 4-Wire adaptor CR-5810 (option)

1-Gauge 4-Wire method strain gauges with modular plug

Compact flash memory card

Measurement data and the contents of setting are recorded on compact flash card. Firmware upgrade through the card is possible.

CF card memory capacities
Maximum 2GB

SYSTEM BLOCK DIAGRAM



INTERFACE

Two types of interfaces, USB and RS-232C are equipped.

USB port

Using the USB cable CR-6187 (option), control of TC-32K from a computer and data read of online measurement are possible. The USB driver is contained in TML measurement software Visual LOG Light (option).

RS-232C port

By connecting the RS-232C cable CR-5532 (option), control of TC-32K from a computer and data read of online measurement can be done.

- Measurement with TML Remote Power Controller RPC-05A
By setting up RPC-05A between TC-32K and a computer or modems, power on/off, control for solar power charge, etc. in long-terms measurement are possible.
- Printout of data
The online measurement data is printed on the external printer DPU-S245-00A-E (option).

DATA MEMORY

The maximum 80000 data in single channel mode can be recorded. The data memory is one area only and the data stored in the area in order of measurement. One data are composed of channel, measurement time, measurement data and physical unit.

- The number of recordable data is 80000.
- When a ring buffer is set to off, if the number of data reaches 80000, 'M' is indicated on the sub-LCD and no more data are recorded.
- Even if a channel is changed, the storage destination of the data is the same.
- The data after storing in a PC should be sorted out by channel.
- If the number of data reaches 80000 at ON of the ring buffer, the oldest data are discarded and the latest data are always recorded.

In the multi-channel mode with the Switching Box CSW-5B, measurements of about 29400 times are possible. One data consists of box number, measurement time, measurement data and physical unit for 5 channels.

- It provides approximately 29400 times of measurement.
- Even if you change the switching box, the data storage destination is the same.
- When the ring buffer setting is 'ON' and the number of data reaches the upper limit, the oldest data are discarded and the latest data are always recorded.
- The data after recorded in a PC should be sorted out by box number and channel.

OPERATING DURATION ON BATTERY DRIVING

Normal operating duration of the alkaline battery is given below.

- Continuous operation

with Auto-Power-OFF not selected

LCD backlight OFF
Monitor display ON
CF card equipped
Environment 23°C

Instrument	Duration
TC-32K unit only	10 hours
TC-32K+CSW-5B	6 hours

- Sleep-interval functioning

with Alkaline battery set

Environment 23°C

Interval time	TC-32K unit only	TC-32K+CSW-5B
1 minute	60 hrs. (2.5 days)	43hrs. (1.8 days)
10 minutes	580 hrs. (24 days)	428 hrs.(17 days)
1 hour	2800 hrs. (116 days)	2400 hrs. (100 days)
3 hours or longer	7200 hrs. (300 days)	6000 hrs. (250 days)

Please note that the above operating duration may vary due to battery type and environments.

Number of measurement points

1-ch	Main unit	Sensor inputs with NDIS connector or via one-touch terminal
5-ch	Combined with CSW-5B	CSW-5B, CSW-5B-05

Applicable sensors

Strain measurement	1-gauge 4-wire method (1G4W)	120Ω 240Ω 350Ω	*For 1-gauge 4-wire method on TC-32K, optional exclusive adaptor should be used. Bridge excitation voltage DC1V 44ms (50Hz)
	3-wire quarter bridge (1G3W)	120Ω 240Ω 350Ω	
	Half bridge(2GAGE)	120~1000Ω	
	Full bridge(4GAGE)	120~1000Ω	
	Full bridge constant current (4G C350Ω)	350Ω	
	Full bridge 0-2V (4G 0-2V)	120~1000Ω	* Bridge excitation voltage DC2V 24ms (50Hz)
DC voltage measurement	DC 300mV DC 30V DC Auto *	±300mV ±30V ±30V	Input impedance V 1/1 500MΩ or more V 1/100 1MΩ or more
Thermocouple temperature measurement	T, K, J, B, S, R, E, N		Linearization: Digital operation JIS C 1602-1995
Pt RTD temperature measurement	Pt100 3W Pt RTD 3-wire		Linearization: Digital operation JIS C 1604-1997 Pt100

* : 1 channel measurement from main unit only

Measurement range

Item	Range	Measurement range	Initial memory	Sampling speed
Strain measurement	x1 x10	±30000x10 ⁻⁶ strain ±300000x10 ⁻⁶ strain	±160000x10 ⁻⁶ strain	80ms (50Hz area) 67ms (60Hz area)
DC voltage measurement	x1 x10	V 1/1 ± 30.000mV ±300.000mV	V 1/1 ±160.000mV	
	x1 x10	V 1/100 ± 3.0000 V ±30.0000 V	V 1/100 ± 16.0000 V	
Thermocouple temperature measurement	-	T: - 250~+ 400°C K: - 210~+1370°C J: - 200~+1200°C B: +200~+1760°C S: - 10~+1760°C R: - 10~+1760°C E: - 210~+1000°C N: - 200~+1300°C	-	
Pt RTD temperature measurement	-	- 200~+850°C	-	

Note : Measurement range of Full bridge 0-2V such as our LVDT is ±15000x10⁻⁶ strain (x1) and ±150000x10⁻⁶ strain (x10).

Thermocouple temperature measurement

Thermo-couple	Measurement range	Resolu-tion	Accuracy (23°C±5°C)	
			External RJC	Internal RJC
T	- 250 ~ - 200°C	0.1°C	±(0.38%rdg+0.6°C)	±(0.38%rdg+3.9°C)
	- 200 ~ - 100°C	0.1°C	±(0.15%rdg+0.2°C)	±(0.15%rdg+1.4°C)
	- 100 ~ +400°C	0.1°C	±(0.10%rdg+0.2°C)	±(0.10%rdg+0.8°C)
K	- 210 ~ - 160°C	0.1°C	±(0.19%rdg+0.3°C)	±(0.19%rdg+1.6°C)
	- 160 ~ 0°C	0.1°C	±(0.12%rdg+0.2°C)	±(0.12%rdg+1.0°C)
	0 ~ +960°C	0.1°C	±(0.08%rdg+0.1°C)	±(0.08%rdg+0.5°C)
	+ 960 ~+1370°C	0.1°C	±(0.10%rdg+0.9°C)	±(0.10%rdg+1.4°C)
J	- 200 ~ - 160°C	0.1°C	±(0.16%rdg+0.2°C)	±(0.16%rdg+1.2°C)
	- 160 ~ 0°C	0.1°C	±(0.12%rdg+0.1°C)	±(0.12%rdg+0.8°C)
	0 ~ +700°C	0.1°C	±(0.08%rdg+0.1°C)	±(0.08%rdg+0.5°C)
B	+ 200 ~ + 280°C	0.5~0.4°C	±(0.04%rdg+4.0°C)	±(0.04%rdg+4.0°C)
	+ 280 ~ + 800°C	0.3~0.1°C	±(0.04%rdg+1.2°C)	±(0.04%rdg+1.2°C)
	+ 800 ~+1760°C	0.1°C	±(0.05%rdg+0.4°C)	±(0.05%rdg+0.4°C)
S	- 10 ~ + 200°C	0.1°C	±(0.09%rdg+0.6°C)	±(0.09%rdg+1.2°C)
	+ 200 ~+1760°C	0.1°C	±(0.07%rdg+0.4°C)	±(0.07%rdg+0.7°C)
R	- 10 ~ + 150°C	0.1°C	±(0.09%rdg+0.7°C)	±(0.09%rdg+1.2°C)
	+ 150 ~+1760°C	0.1°C	±(0.07%rdg+0.4°C)	±(0.07%rdg+0.7°C)
E	- 210 ~ + 550°C	0.1°C	±(0.17%rdg+0.2°C)	±(0.17%rdg+1.4°C)
	+ 550 ~+1000°C	0.1°C	±(0.09%rdg+0.4°C)	±(0.09%rdg+0.8°C)
N	- 200~ 0°C	0.1°C	±(0.18%rdg+0.4°C)	±(0.18%rdg+1.6°C)
	0 ~+1090°C	0.1°C	±(0.08%rdg+0.2°C)	±(0.08%rdg+0.6°C)
	+1090 ~+1300°C	0.1°C	±(0.08%rdg+0.9°C)	±(0.08%rdg+1.2°C)

The accuracy of thermocouples is not included. Thermocouple B does not use RJC. RJC: Reference junction compensation

Measurement accuracy

Sensor mode	Range	Resolution	Accuracy (23°C±5°C)	Tempera-ture effect (%rdg/°C)	Aging effect (%rdg/year)
Strain except 1G4W	x1	1x10 ⁻⁶ strain	±(0.08%rdg+1digit)	±0.002	±0.02
	x10	10x10 ⁻⁶ strain	±(0.08%rdg+1digit)	±0.002	±0.02
Strain with 1G4W	x1	1x10 ⁻⁶ strain	±(0.28%rdg+1digit)	±0.002	±0.02
	x10	10x10 ⁻⁶ strain	±(0.28%rdg+1digit)	±0.002	±0.02
DC voltage V1/1	x1	0.001mV	±(0.08%rdg+3digit)	±0.0024	±0.02
	x10	0.010mV	±(0.08%rdg+3digit)	±0.0024	±0.02
DC voltage V 1/100	x1	0.0001V	±(0.08%rdg+2digit)	±0.002	±0.02
	x10	0.0010V	±(0.08%rdg+2digit)	±0.002	±0.02
Pt RTD Pt100 3W	-	0.1°C	±(0.08%rdg+0.3°C)	±0.002	±0.05

Range: in auto-ranging

For resistance measurement with 2-wire, no leadwire resistance is included.

Leadwire resistance correction

Comet B (3-wire quarter bridge)	Gauge resistance	Leadwire resistance correction range
	120Ω	Approx. 100Ω or less
	240Ω	Approx. 200Ω or less
	350Ω	Approx. 300Ω or less

Check function

Insulation	Insulation resistance between sensor and specimen
Resistance	Sensor resistance between terminal A and B for input
Scattering	Measurement values when scattered
Coefficient set	Multiplication results by coefficient set when 100, 1000 or 10000μV or equivalent signal is input.

Item	Insulation resistance	Resistance measurement
Range	0~500MΩ	0~30kΩ
Accuracy	±20%rdg on battery working	0~3kΩ ±(0.5%rdg+0.2Ω) 3k~30kΩ ±(0.5%rdg+2Ω)
Resolution	0.1MΩ	0.1Ω (0~3kΩ) 1Ω (3k~30kΩ)
Sampling speed	Approx. 1s	Approx. 0.5s
Remarks	Excitation 2.5V	10μA constant current method

Display and Function

Display	Display unit	LCD display with backlight
	Resolution	255x160 dots
	Contents	Measurement data, Setting list, Y-T monitor
Clock	Setting	Year, Month, Day, Hour, Min. and Sec.
	Accuracy	±1 sec./day (23°C±5°C)
Interface	USB, RS-232C	
	Function	Control command from PC and Data transfer
Measurement mode	INITIAL, DIRECT, MEASURE for each channel (Direct mode only for temperature measurement)	
Changing method of measurement points	Scanning	Automatically changed from channel *0 through *4 to measure (when CSW-5B is connected only. * means box number, any channel can be skipped.)
	Monitor	Monitor channel is measured repeatedly. Displayed graphically according to time transition.
Start of measurement	Start key switch, Interval timer, USB, RS-232C	
Program setting	Capable of setting for each channel	
	Coefficient	±(0.0001~99999)
	Unit	40 kinds such as με, mV, °C, kN and mm
	Decimal point	Any 0~6 decimal places
	Initial value	Writing for every channel
SIMPLE measure	Sensor mode	Setting for every sensor
	Coefficient	1.0000
	Unit	Linked to sensor mode
Self-diagnosis	Decimal point	Linked to sensor mode
	Upgrade indication, battery, dispersion and burnout check	
TEDS	Standard	IEEE1451.4 Class 2
	Function	Readout of TEDS sensor parameters
Interval timer	Function	Automatic start according to the set time interval and time
	Interval	Hour, Min. and Sec. up to 99H 59M 59S for each step
	No. of starts	Programmable 99 times at max. or infinite per step
	Real time start	Sets a start time (Day Hour Min. Sec.) for each step
	GOTO step	Looping previous step

Interval timer	Sleep ON/OFF	Automatically switches on 5 seconds before measurement time and turns off after measurement
Data memory	Function	Storing and reading of measurement data
	Contents	Measurement mode, Channel number, Measurement data, Time data and Data number
	Capacity	80000 data at max.
	Storage	About 20 days with full charge
Memory card	Standard	CF card
	Capacity	Maximum 2GB
Auto-power-OFF		Automatically turns off when not receiving any key operation and RS-232C commands for any set time. Switchable On/Off.
Vibration resistance		29.4m/s ² (50Hz 0.6mmp-p)
Shock resistance		49m/s ²
Protection rating		IP-54 with connector cap

Operational time in continuous use	Alkaline battery : Approx. 10 hours (Strain measurement in 350Ω full bridge)	
Operational environment	-10~+50°C 85%RH or less without condensation	
Storing temperature	-20~+60°C	
Power requirement	LR6 Alkaline cell 4 pieces Exclusive AC adaptor CR-1869 or External battery 9~18V DC	
Dimensions	102(W)×49(H)×223(D) mm	
Weight	0.8 kg.	
Standard accessory	LR6 Alkaline cell	4 pieces
	Carrying belt	1 piece
	Operation manual	1 copy
	Accessory box	1 piece

Outer view and Dimensional diagram

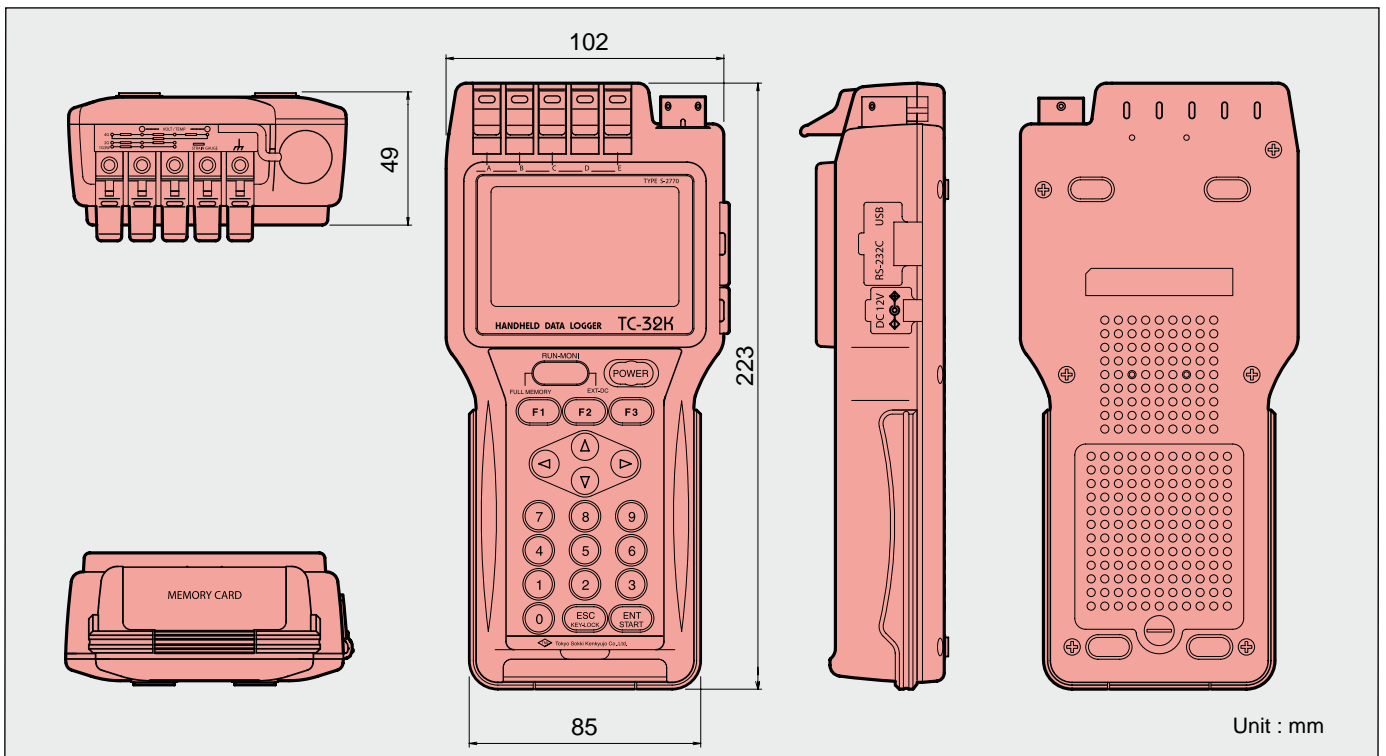

Pop-up operation guide

[Menu]

```

2015/07/25 06:08:35
** menu **
1. Program setting
2. Direct meas/switch
3. Auto measurement setting
4. Various checks
5. Setting concerning measurement
6. Memory
ex-page Next page

```

[Automatic measurement]

```

2015/07/25 06:12:01
** Auto measurement setting **
1. Setting of interval measurement
2. Start and stop of interval

```

[RS-232C parameter]

```

S 2015/07/01 13:58:0?
** RS-232C setting **
1. Baud rate 9600
2. Data bit 8bit
3. Parity Non
4. Stop bit 1bit
5. Flow control Off
6. Time out 05Sec

```

[Sensor mode]

```

S 2015/07/01 14:02:29
** Sensor mode list **
1G3W 120Ω 2GAGE
1G3W 240Ω 4GAGE
1G3W 350Ω 4G C350Ω
1G4W 120Ω JUMP
1G4W 240Ω
1G4W 350Ω
ex-page Next page

```

[Measurement mode]

```

2015/07/25 06:18:47
** Measurement mode switch **
Single channel mode
Multi channel mode
Clinometer 1 axis mode
Clinometer 2 axis mode

```

[Recognition of TEDS sensor]

```

2015/07/25 06:17:58
** TEDS sensor Info reading **
Ch Cap Ro Unit
00 +1.0000E+2 N 3000μ ε
01 +0.0000E+0 0μ ε
02 +0.0000E+0 0μ ε
03 +0.0000E+0 0μ ε
04 +0.0000E+0 0μ ε
Read Set

```

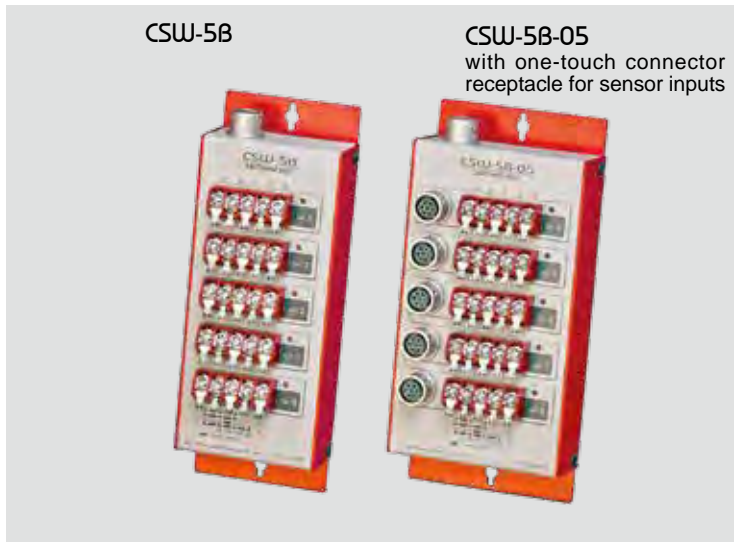
The CSW-5B switching box is combined with TC-32K when 5-channel extension is needed. It can accept strain gauges, DC voltage, thermocouples and Pt RTD. The CSW-5B-05 has a connector receptacle for NDIS 7-pin connector plug for each channel as well as ordinary terminal board.

■ Features

- Capable of measuring strain, DC voltage, thermocouple and Pt RTD.
- Sensor mode setting by TC-32K
- Sensor connection by terminal screwing and soldering
- Small and lightweight

■ Combination with TC-32K

Connection cable CR-655 supplied with CSW-5B



■ Program setting

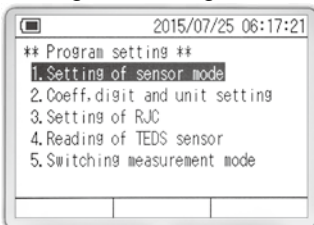

The setting of sensor mode, coefficient, digits, unit, RJC, etc. is the same as single channel mode, but TEDS sensor is not applicable.

■ Multi-channel mode

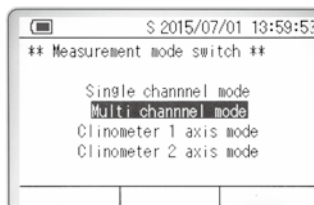

By selecting the Multi-channel mode, CSW-5B setting, monitoring and automatic measurement become possible.

■ SPECIFICATIONS

Applicable instrument	TC-32K
Number of measurement points	5
Strain measurement	
Quarter bridge 3-wire	120Ω, 240Ω, 350Ω
1-gauge 4-wire method	120Ω, 240Ω, 350Ω
Half bridge	120 ~ 1000Ω
Full bridge	120 ~ 1000Ω
Full bridge constant current	350Ω (cable total resistance within 200Ω)
Full bridge 0-2V	120 ~ 1000Ω
Measuring range	Conforms to TC-32K
Sensitivity drop	
×1 range	±(0.08%rdg+1 digit)-0.33%rdg or less
×10 range	±(0.08%rdg+2 digit)-0.33%rdg or less (Except full bridge constant current)
DC voltage measurement	
Measuring range	Conforms to TC-32K
Voltage measurement	±300mV ±30V
Allowable input voltage	300mV range ±5V 30V range ±35V
Thermocouple temperature measurement	
Measuring range	T, K, J, B, S, R, E, N
Pt RTD temperature measurement	
Measuring range	Conforms to TC-32K
Measuring method	3-wire system
Channel number	Fixed (CH0 ~ CH4)
Measuring channel indication	Red LED for each channel
Switching relay	Semiconductor relay
Environment	-10 ~ +50°C, 85%RH or less without condensation
Power supply	Supplied from TC-32K
Dimensions (excluding projected parts)	
CSW-5B	75 (W) × 35 (H) × 204 (D) mm
CSW-5B-05	95 (W) × 35 (H) × 204 (D) mm
Weight	
CSW-5B	500g
CSW-5B-05	650g
Standard accessories	
Operation manual	1 copy
Connection cable CR-655	1 piece
Accessory box	1 piece

[Option]

Simple waterproof case

■ CSW-5B Box No. setting

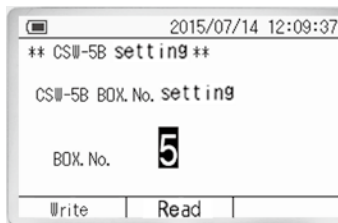

Applicable switching boxes are set from 0 to 9 figures for 10 units at maximum, saving the setting conditions as well as measurement data.

■ Monitoring

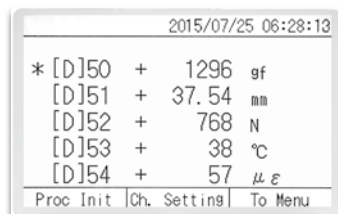

Real time monitoring is available for all 5 channels of the connected box and marked sequentially with blinking.

OPTION

1-Gauge 4-Wire Adaptor CR-5810



1-Gauge 4-Wire method strain gauge with modular plug

Remote Power Controller RPC-05A

In combination with RPC-05A and an external battery, long-term measurement with TC-32K using sleeping function becomes possible.



Exclusive cable CR-5353 for connection with TC-32K

External Printer DPU-S245-00A-E

The measurement data of TC-32K is printed out.



Printer cable CR-4511 Dsub9P-10P (mini) thru 0.5m

RS-232C cable CR-5532

Dsub9P-10P(mini) Cross1.5m
Exclusive cable for connection with PC

USB cable CR-6187

Mini B-A with ferrite core1.5m
Exclusive cable for connection with PC

AC adaptor CR-1869

CF card

Capacity 2GB at maximum



2-axial inclinometer adaptor IA-33/IA-32



The inclino adaptor is designed to measure biaxial inclination with our Handheld Data Logger TC-32K. With setting of Inclino mode on the TC-32K, 2 axes inclinations in X and Y directions can be measured simultaneously.

SPECIFICATIONS

Applicable instrument	TC-32K
No. of measurement points	2
Accuracy	Conforms to TC-32K
Power requirement	Supplied from TC-32K 5V DC
Environment	-10~+50°C 80%RH or less (without condensation)
Outer dimension	95(W)x42(H)x85(D) mm
Weight	300g

TEDS compatible sensors

To use TEDS function of the TC-32K, TEDS compatible sensor is required to recognize its own parameters such as measurement range, rated output, etc. registered in the built-in IC chip.



TEDS compatible load cell TCLZ with the built-in IC chip.

Monitoring Measurement Software

Visual LOG[®] Light TDS-700L

The Visual LOG[®] Light is control software for monitoring measurement using our data loggers and a PC. The software can control a TC-32K (1-channel measurement) or a combination of TC-32K and CSW-5B/CSW-5B-05 (5-channel measurement). All controls and data readings are made by the PC directly connected to the TC-32K through RS-232C or USB interface. Three systems of interval timer program can be set, and on-line measurement is possible manually or by using the interval timer.



Applications

Checking of various sensors

The one-touch type terminal board of the TC-32K enables speedy connection and disconnection of lead wires. It is very convenient for checking zero balance, resistance and insulation resistance of strain gauges and strain gauge type transducers installed on the site. Since the TC-32K can measure DC voltage, thermocouple and Pt RTD in addition to strain, it is also capable of checking various sensors.

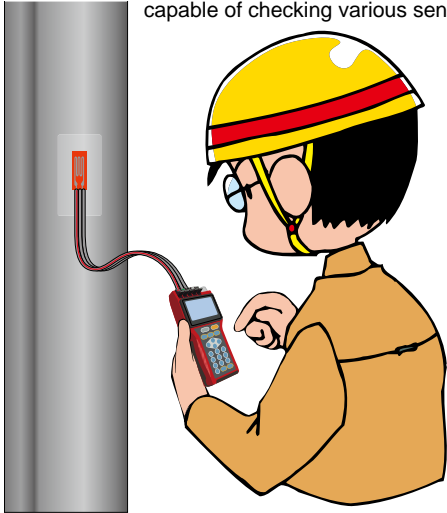

Manual measurement

Data acquisition is possible by connecting each one sensor to the TC-32K or each five sensors to the switching box CSW-5B. It is suited to use in small-scale test having one to five measurement points, or observation during and after construction where measurement points are scattered in two or more locations. The TC-32K is also applicable to on-line measurement using a PC.

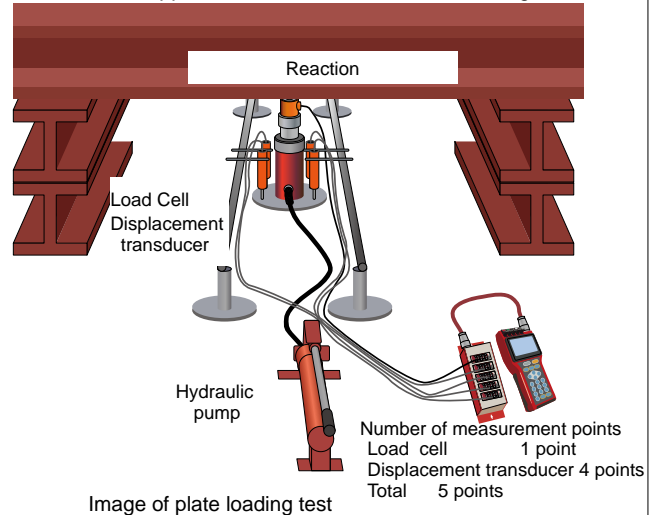

Long-term unmanned measurement

The TC-32K is equipped with sleep function, which turns off the main power automatically when not measuring during interval timer measurement for the purpose of saving consumption of batteries. Long-term observation during and after construction becomes possible by periodically collecting the data and replacing the batteries.



Battery-driven time using onboard sleep timer

Interval time	Ambient temperature: 23°C		Ambient temperature: 0°C	
	Single unit of TC-32K	+ CSW-5B	Single unit of TC-32K	+ CSW-5B
1 minute	2.5 days (60 hours)	1.8 days (43 hours)	1.75 days (42 hours)	1.2 days (30 hours)
10 minutes	24 days	17 days	16 days	12 days
1 hour	116 days	100 days	81 days	70 days
3 hours or more	300 days	250 days	208 days	145 days

※The above operating time is an example with alkaline dry batteries

Remote observation

The TC-32K is equipped with RS-232C interface. Measured data can be collected and managed in a remote place by using a modem or a protocol converter for e-mail transmission.



Example of remote measurement system using protocol converter

Specifications are as of March 2016 and are subject to change without notice.



Tokyo Sokki Kenkyujo Co., Ltd.
www.tml.jp/e

8-2, Minami-Ohi 6-Chome, Shinagawa-Ku, Tokyo 140-8560, JAPAN
 TEL: +81-3-3763-5614 FAX: +81-3-3763-5713
 email address: sales@tml.jp

Approval Certificate **ISO9001**
 Design and manufacture of
 strain gauges, strain measuring
 equipment and transducers