

Static Measurement Software TDS-7130v2

TDS-7130v2-A (Special version applicable to long-term measurement and alarm contact)

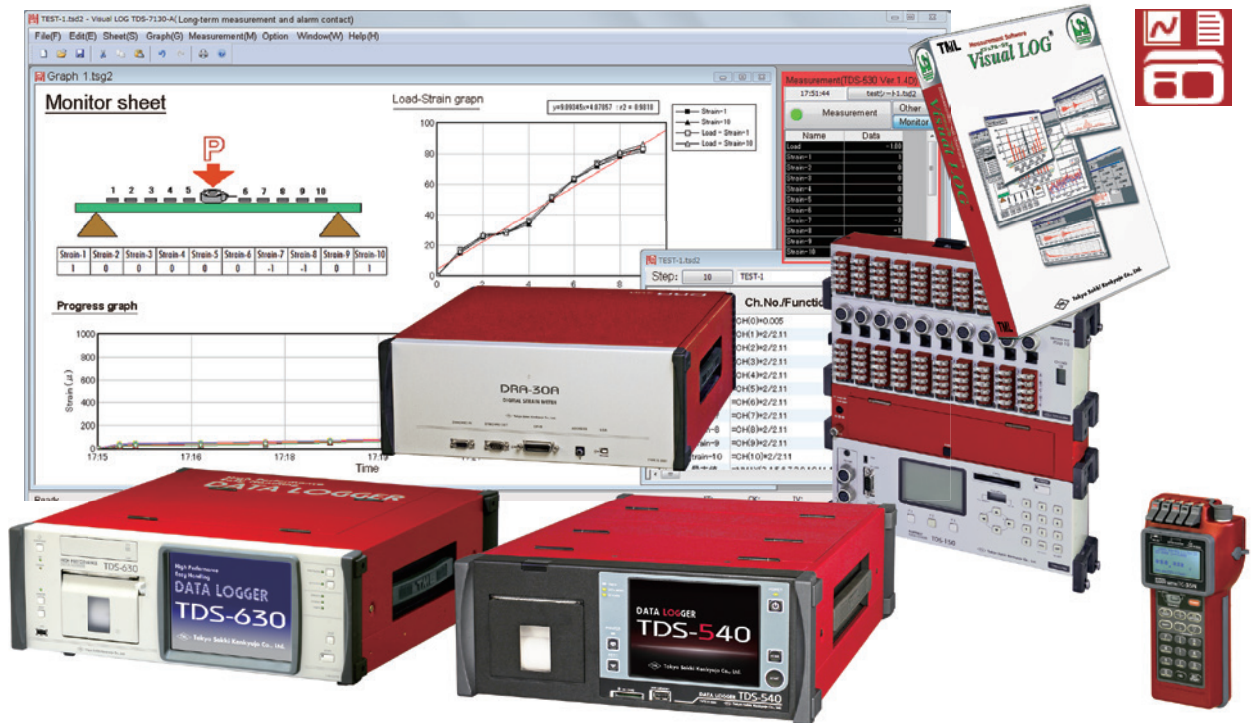

The TDS-7130v2 runs on a MS Windows PC to perform static measurement using TML data loggers. In addition to visual representation with multiple graphs, this software is a powerful tool for creating a report with data and graphs because it is capable of pasting multiple graphs, value monitors, labels and images on one graph sheet. It can take the most advantage of the data logger function of automatic multi-channel measurement.

The TDS-7130v2-A, applicable to long-term measurement and alarm contact, is optionally available. It has additional functions including automatic start of measurement, alarm output using contact unit, and automatic scroll of progress monitor. With these functions, the software is suitable for observation during and after construction, and construction management.

- User interface design compatible with wide-screen display
- Number of measuring times is 20 million at the maximum; applicable to long-term continuous measurement.
- For interval timer and data comparator, 8 tables can be created and executed respectively.
- 9 data lists for optional data items can be created in addition to original data list for all data items; data output can be modified according to processing.
- Continuous measurement by every 0.1 seconds is possible corresponding to high speed mode of TDS-630.
- Two or more graphs are indicated on one graph sheet.
- Vector monitor and arrow monitor are indicated on graph sheet.
- Storage and reproduction of screen layout
- Optional TDS-7130v2-A is the most suitable for long-term management measurement.



Setting sheet

Setting sheet is a file for setting measurement conditions, and recording and listing data. It consists of nine items as instrument I/F, measurement conditions, coefficient setting supplement, TML-NET, interval measurement, data comparator measurement, check results, data table, and data list. Setting sheets can be switched by task or menu.

- The maximum number of measurement can be increased from 50 thousand times to 20 million times by changing the maximum number of data items from 4000 points to 10 points.
- Each 8 tables can be created and executed for both of interval timer and data comparator.
- One data list for all items and 9 data lists for optional items can be created for data output corresponding to data processing.

Setting sheet

Menu is always displayed by dragging the horizontal line part of the top of the menu. This is convenient for frequently used menu.

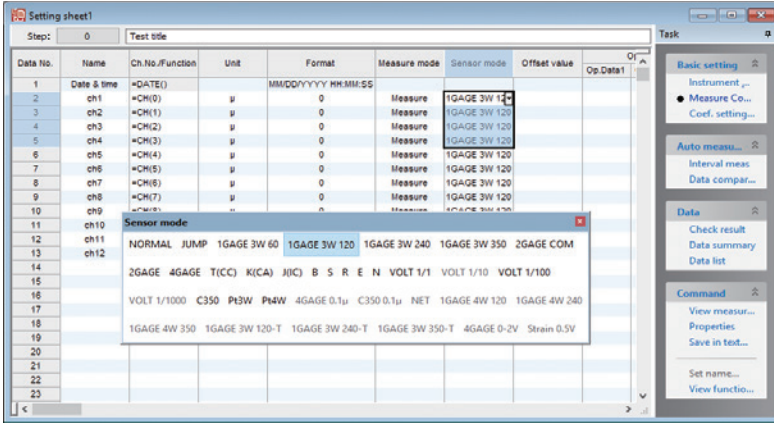

Function panel

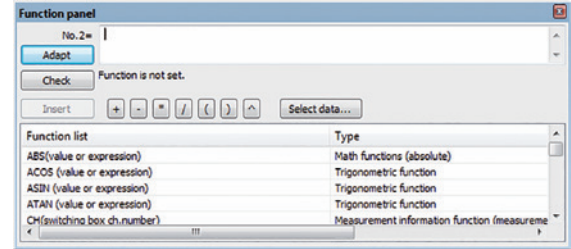

Function panel makes it easy to input Ch. No./Function equation.

Graph sheet, Free form

Various graphs, images, drawings and value monitor can be arranged freely.

- Possible to display two or more free forms and/or graph sheets at the same time
- Two or more graphs can be arranged on one graph sheet.
- Monitor point can always be displayed in the graph.
- Graph can be updated according to data by specifying the number of measurements for graph drawing or by enabling automatic updating by measurement.
- Regression line can be drawn from the measurement result.
- Windows of setting sheets and graphs can be gathered in one window by using tab display.
- Display location of all displayed windows can be saved into and reproduced from layout file.

Line graph

Line/Scatter

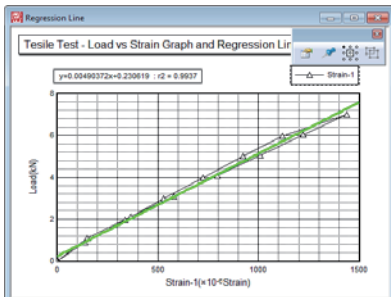

Regression line is drawn from the measurement result

Progress graph

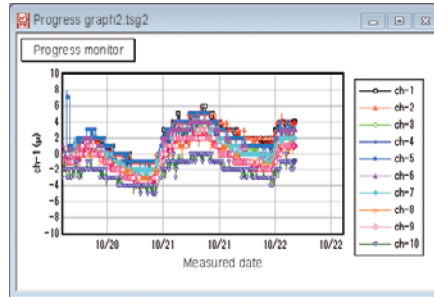

Draws T-Y graph

Progress monitor (option)

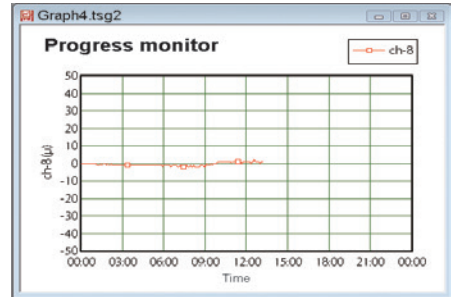

Draws progress graph by optionally specified days or hours. This is available with TDS-7130v2-A.

Distribution chart

X/Y bar graph

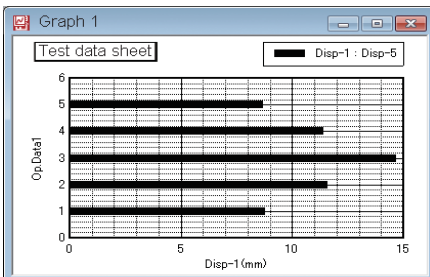

This is drawn on the coordinate data for distribution chart which are input into Op.Data.

X/Y graph distribution

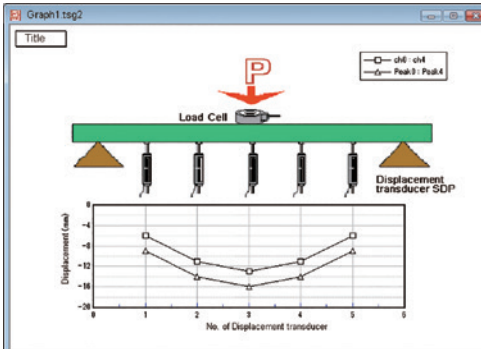

• **Additional object**

Value monitor

Value monitor			
ch-1	ch-2	ch-3	
38	81	171	
Name	ch-4	ch-5	ch-6
Current	124	221	263
Maximum	149	254	302
Minimum	-32	-64	-73

Value monitor is added on the free sheet or graph sheet. Name, current value, maximum/minimum value and unit can also be indicated. Items satisfying the alarm condition are indicated in a different color.

Characters

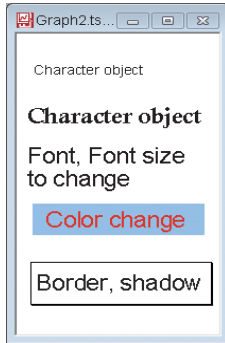

Comment and title can be added optionally on free form and graph sheet.

Vector monitor

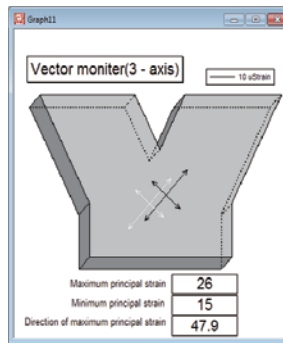

Principal stress and strain are indicated by arrow. The line color changes when the alarm condition is satisfied.

Arrow monitor

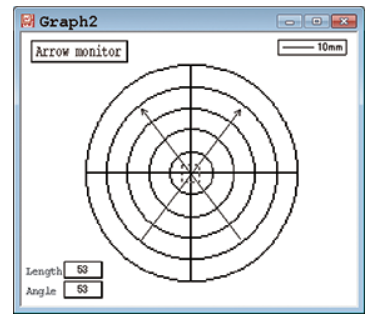

Direction and magnitude are indicated by arrow. The line color changes when the alarm condition is satisfied.

Measurement with data logger TDS-630 in HSP (high speed mode)

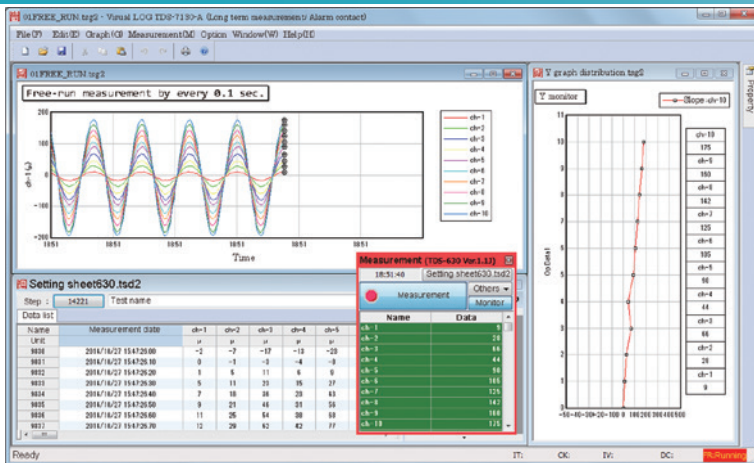

The data logger TDS-630 can make repeated measurement of up to 1000 channels by every 0.1 seconds.

This software applies to HSP in online mode so as to take full advantage of the functions of TDS-630. Measurement can be taken at intervals of 0.1 seconds when using internal or TML-LINK applicable switching boxes with TDS-630.

TDS-7130v2-A (applicable to long-term measurement and alarm contact)

For the TDS-7130v2-A, the following functions are added to those of the TDS-7130v2.

- Controls an external alarm device and transmits the alarm occurrence outside the PC.
- Automatically opens measurement panel and starts specified automatic measurement.
- Automatically saves the text file of data list which is optionally specified during measurement.
- When alarm occurs, creates text file of alarm occurrence conditions.
- Draws progress graph by optionally specified days or hours.

Measurement system

Example of basic system using TDS-7130v2



Example of measurement and observation system using TDS-7130v2-A

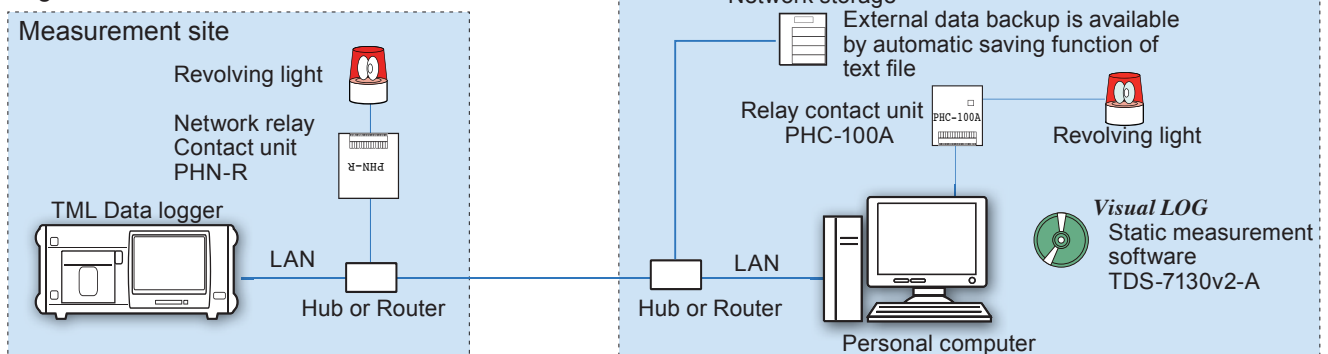

Specifications

Measurement condition

Maximum number of data items To be set between 10 and 4000 (including calculation result)
Maximum number of measurement 50,000 ~ 20,000,000 times (varies depending on the setting of number of data items) Depends on the capacity of installed memory and disk.
Setting item Name, Ch.No./Function, Unit, Format, Measurement mode, Offset value, Sensor mode, Optional data, Alarm
Interval measurement 8 tables can be set and executed simultaneously.
Data comparator measurement 8 tables can be set and executed simultaneously.
Measurement mode Monitor, Manual measurement, Interval measurement, Data comparator measurement, Free run measurement, Alarm measurement, Alarm interval measurement, Data input measurement, Stroke change, Initial measurement, Check
Alarm display Displays alarm occurrence status on the alarm panel and monitor according to the alarm condition set by the measurement condition.
Data list Following lists can be displayed. 1 data list to show all measured data for every measurement date 9 data lists to show measured data for optionally selected items
Maximum/Minimum value display Maximum and minimum values for every data item are displayed in the data list
Data table Optional measurement data can be displayed in a table by specifying the number of measurement
Check result Displays direct value in initial measurement and result of checking
Reading data recorded by data logger Reads data stored in recording media by connecting the media to a PC Reads data directly from recording media of the data logger
Graph Free form, Graph sheet Various graphs, images, drawings and value monitor are arranged freely. Two or more free forms and/or graph sheets can be displayed simultaneously. Two or more graphs can be arranged on one graph sheet.
Saving and reproduction of layout Display location of all displayed setting sheets, free forms and graph sheets are saved into file, and the display is reproduced by reading the file.
Type of graphs Line, Scatter, Progress, Vertical bar graph, Horizontal bar graph, X graph distribution, Y graph distribution, Value monitor, Vector monitor, Arrow monitor
Saving of measurement data Measurement data are saved in the same setting sheet as the measurement condition. Saved automatically at every measurement. Text conversion: Measurement data are saved in text format file (separated by tab) or in CSV format file (separated by comma). Saving of free form and graph sheet
Conversion of free form and graph sheet Since free form and graph sheet can be saved in BMP, EMF or PNG format, they can be read using commercially available software, and graphs can be modified. Text conversion of graph: Saves all data displayed in the graph in text format file (separated by tab) or in CSV format file (separated by comma).

Functions added to TDS-7130v2-A (special version applicable to long-term measurement and alarm contact)

- Control of external alarm device
Drives external device such as revolving light using external relay control unit (option).
Occurrence of alarm can be transmitted outside PC.
Controls are possible for one PHC series of serial connection and for three PHN-R of network type.
- Improvement of supplemental function for automatic measurement
Starts various measurement functions when any setting sheet is opened.
Saves text file automatically at the time of measurement.
Creates text file of conditions of alarm occurrence.
- Addition of progress monitor
Draws progress graph by arbitrarily specified days or hours.

Operating environment

OS	Microsoft Windows Vista(SP2), 7(SP1), 8, 8.1, 10
Computer	Model which satisfies the specifications recommended by the above OS and also has USB port (Dual core or more), CD drive
Interface	
GP-IB	Manufactured by National Instruments Corporation or CONTEC Co., Ltd.
RS-232C	COM 1 ~ 8
USB	USB2.0
LAN	10BASE-T/100BASE-TX

Conditions for applicable data logger/instrument

Applicable instrument	Applicable version	Interface				Measuring points
		LAN	USB	RS-232C	GP-IB	
TDS-540	1.0C or later	○	○	○		1000
TDS-630	1.1C or later	○	○	○		1000
TDS-530	1.0C or later	○	○	○		1000
TDS-150		○*	○	○		100
DRA-30A	1.0B or later		○		○	300
NIF-100	1.0D or later			○		100
TC-35N				○		100
THS-1100	1.1A or later			○	○	1000
THS-1000					○	500
TDS-602	1.0G	○*		○	○	1000
TDS-601	1.4A or later			○	○	1000
TDS-601A	1.4A or later			○	○	1000
TDS-303	1.0E or later	○		○	○	1000
TDS-302	1.2A or later			○*	○	1000
TDS-300				○		250
TDS-102	1.0F or later			○		100

*: Option

Related products

USB – RS-232C serial conversion adaptor

This is an adaptor to convert RS-232C connection of instrument into USB connection.

USB-RSAQ6 manufactured by I-O Data Device, Inc.

GP-IB interface

This is an extended interface used for connecting an instrument having GP-IB interface to a personal computer. The TDS-7130v2 is applicable to GP-IB interface manufactured by National Instruments Corporation or by CONTEC Co., Ltd.

- PCI-GPIB, etc. manufactured by National Instruments Corporation
- GP-IB(PCI)F, etc. manufactured by CONTEC Co., Ltd.

Relay unit (when using TDS-7130v2-A)

- Personal computer output relay unit PHC-100A/PHC-100 manufactured by PATLITE Corporation
- Network relay control unit PHN-R manufactured by PATLITE Corporation



Approval Certificate **ISO9001**
Design and manufacture of strain gauges, strain measuring equipment and transducers

Visual LOG is a registered trade mark of Tokyo Sokki Kenkyujo Co., Ltd.

Contents of this catalog are subject to change without prior notice.
Contents of this catalog are as of November 2016.



Tokyo Sokki Kenkyujo Co., Ltd.
www.tml.jp/e

8-2, Minami-Ohi 6-Chome, Shinagawa-Ku, Tokyo 140-8560, JAPAN

TEL: +81-3-3763-5614 FAX: +81-3-3763-5713

email address: sales@tml.jp