

**TML**

**STRAIN GAUGES**

**2021**

Precise & Flexible



### INTRODUCTION

This catalog presents the full range of Our standard strain gauges and associated products including bonding adhesives and coating materials manufactured by Tokyo Measuring Instruments Laboratory Co., Ltd. It also describes how to find specific strain gauges, introduces typical applications, and defines the most commonly used technical terms.

Prior to using the catalog, please check the information listed below.

#### CHANGES IN SPECIFICATIONS

In the interest of product improvement, the specifications in this catalog are subject to change without prior notice.

#### DIMENSIONS

Dimensions are mainly given in millimeter. Strain gauge patterns are in actual size, with enlargements of some miniature patterns.

#### PRICES

Prices are not listed in this catalog. For price information or orders, please contact us or your local representative.

#### HANDLING STRAIN GAUGES

1. The technical data supplied herein do not reflect the influence of the leadwire. The data must be corrected in accordance with the effect caused by the leadwire.
2. The service temperature of a strain gauge depends on the operating temperature of the adhesive, etc.

3. Insulation resistance should be checked at a voltage of 50V or less.
4. Do not apply an excessive force to the gauge leads.
5. Apply adhesive to the back of the strain gauge and attach the gauge to the specimen.
6. The back of each strain gauge has been washed and degreased. Do not contaminate it by touching it directly.
7. For maintaining quality, store products in a dry place.

#### HANDLING BONDING ADHESIVES AND COATING MATERIALS

1. Read the operation manual carefully before using bonding adhesives and coating materials.
2. After using an adhesive, wipe all remaining adhesive off the container and nozzle with a cloth, and replace the cap.
3. After using an adhesive, put the container back in the package and store it in a cool, dark place away from fire.
4. If an adhesive contacts skin or clothing, wash well with soap and water.

If you have any questions about this catalog, please contact us or your local representative.



## STRAIN GAUGES

Stress measurement technologies are indispensable for ensuring the safety and efficiency of all kinds of structures. Since its founding in 1954, Tokyo Measuring Instruments Laboratory Co., Ltd. has been a specialized manufacturer of stress measuring instruments including strain gauges and related products. Throughout the history of more than 60 years, the company has striven to meet the needs of the times and to provide trustworthy products that can be used with full reliability.

Strain Gauges are our main products, and we unveiled the world's first polyester strain gauge in 1956. This new gauge brought about a great improvement in the humidity resistance of gauge backings compared to the strain gauges with paper backings which were popular at that time. Since then, our various technologies represented by the development of foil strain gauges and high temperature strain gauges have enabled reliable measurements under diverse conditions.





Our strain gauges are manufactured under a fully integrated system that covers all stages from development to tests and inspections, and the utmost attention is paid to quality management in all processes. Our strain gauges, which we manufacture in the cleanest environment using the best materials available, are tested and inspected according to international standards, most notably NAS942, the National Aerospace Standard.

### Strain gauges Testing and Inspection Standards

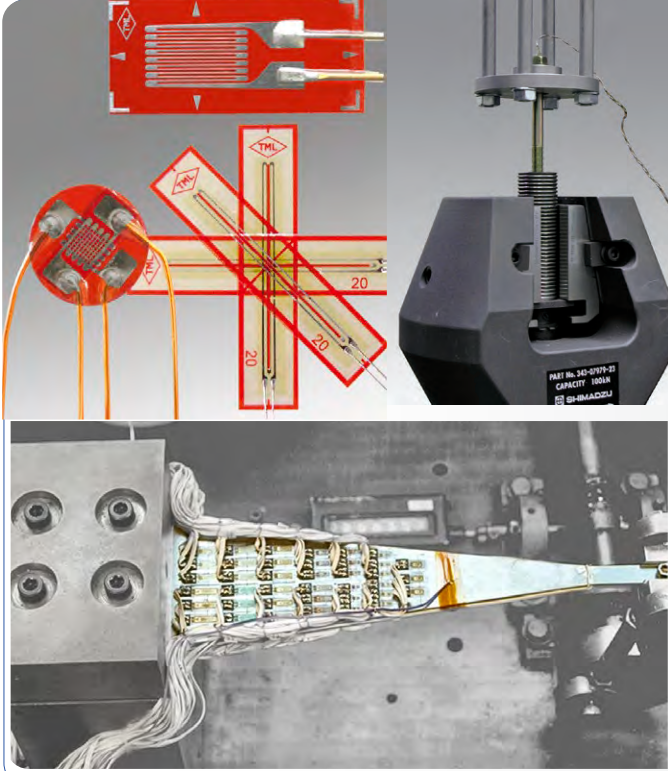

#### Testing and Inspection Standards

- ¶ Visual and Microscopic Inspections  
TML Inspection Procedures and Standards
- ¶ Gauge Resistance  
TML Procedures and Inspection Standards
- ¶ Gauge Factor  
ASTM E251, NAS942 and BS6888
- ¶ Transverse Sensitivity  
ASTM E251 and NAS942
- ¶ Temperature Coefficient of Gauge Factor  
ASTM E251 and NAS942
- ¶ Thermal Output  
ASTM E251 and NAS942
- ¶ Strain Limits  
NAS942
- ¶ Fatigue Life  
NAS 942
- ¶ Creep  
NAS942
- ¶ Drift  
NAS942

### Principal standards used for strain gauge calibration and standard test methods

- ¶ ASTM E251-74  
"Standard Test Methods for Performance Characteristics of Metallic Bonded Resistance Strain Gauges"  
Designation: E251-92, ASTM
- ¶ BSI BS6888  
"Methods for Calibration of Bonded Electric Resistance Strain Gauges"  
Draft for development 6:1972. BSI
- ¶ NAS942  
"Strain Gauges, Bonded Resistance"  
Classification Specification NAS 942, 1963
- ¶ VDE/VDI Richtlinien NR 2635  
"Bonded Electric Resistance Strain Gauges with Metallic Measurement Grids - Characteristics and Testing Conditions"  
VDE/VDI-Richtlinien NR 2635 August, 1974
- ¶ Other standards  
JIS Z2300-91 - "Glossary of Terms Used in Nondestructive Testing", Japan Industrial Standard  
NDIS 4001:2008 - "Glossary of Terms Relating to Electric Resistance Strain Gauges", NDI, Japan



Table of contents

Strain Gauge Applications ..... 5  
General Description ..... 7  
Technical Terms ..... 9  
Strain Gauge Measurement ..... 11  
Strain Gauge Bridge Circuit ..... 17  
Strain Gauge Coding System ..... 19  
Strain Gauge Selection ..... 21  
Package Designation ..... 27  
Primary Installation Bonding / Overcoating ..... 29  
Strain Gauge Installation..... 31  
Strain Gauge Extension Leadwires ..... 32  
How are integral leadwires jointed..... 35  
Combination use of strain gauges and dedicated leadwires ..... 39  
CE compliant strain gauge ..... 41  
General use strain gauges F series GOBLET compliant to CE marking ..... 42  
General use strain gauges F series ..... 45  
Waterproof strain gauges WF series ..... 47  
High temperature strain gauges QF series GOBLET compliant to CE marking ..... 48  
High temperature strain gauges QF series ..... 49  
High temperature strain gauges ZF series ..... 50  
High temperature strain gauges EF series ..... 51  
High and Low temperature strain gauges CEF series ..... 52  
Cryogenic temperature strain gauges CF series..... 53  
Weldable strain gauges AW series ..... 54  
Spot Welder W-50RC ..... 58  
Concrete material use  
    Bondable type P series ..... 59  
    Bondable type PF series ..... 60  
    Bondable type FLM / WFLM series ..... 61  
    Embedment type PMF series ..... 62  
Asphalt Pavement use  
    Embedment type PMFLS series ..... 62  
Concrete material use / Asphalt pavement use / Civil Engineering  
    Strain Transducer KM / KM-HAS series ..... 63  
Composite materials use UBF ..... 65  
Composite materials use BF series GOBLET compliant to CE marking ..... 66  
Low elastic modulus materials use GF series GOBLET compliant to CE marking..... 67  
Wood materials LF series GOBLET compliant to CE marking ..... 68  
Wood materials PFLW / PLW series ..... 69  
Magnetic field strain gauges MF series ..... 70  
Magnetic field strain gauges QMF series..... 71  
Post-Yield Strain gauges YEF series GOBLET compliant to CE marking ..... 73  
Post-Yield Strain gauges YF series, YHF series..... 74  
High endurance Strain Gauges DSF series, One-side Strain Gauges DD series ..... 76  
Crack Detection Gauges FAC series, Stress Gauges SF series ..... 77  
Temperature Gauges TF series, Platinum RTD / Thermocouple ..... 78  
Bolt Strain Gauges BTM series, BTMC series ..... 79  
Transducer-specific Strain Gauges ..... 82  
Frictional strain gauges  
    Frictional Strain Checker FGMH series ..... 83  
    Frictional Axial Strain Transducer FGAH-1B ..... 85  
    Frictional Torque Sensor System FGDH-3A ..... 86  
Residual stress measurement ..... 87  
Strain Gauge Adhesives ..... 89  
Coating Materials ..... 91  
Gauge Protector, Coating Tape ..... 93  
Connecting Terminals / Strain Gauge Clamp Gauge Mate / Pressee ..... 94  
Strain measuring instruments..... 95



### Miniature strain gauges

Printed circuit boards and surface mounting parts of automobile, computers and industrial machinery are getting smaller. Miniature strain gauges can be installed in a very limited gauge installation space.

Strain gauges in the valley of gear

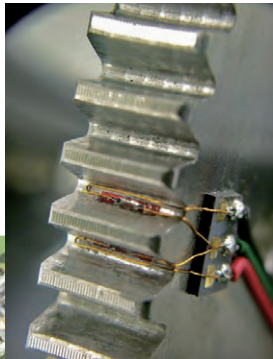

Strain gauges on printed circuit board

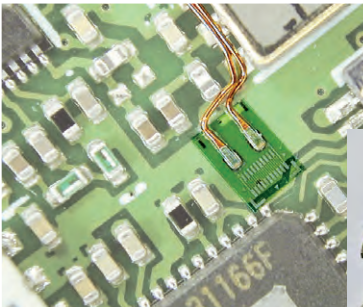

10-element chain type strain gauges on bolt head

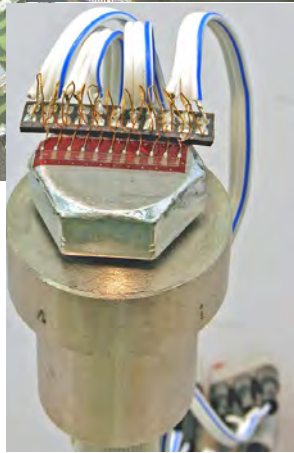

### Shearing strain and torque measurements

Shearing strains in 45-degree direction generated by shearing stress.

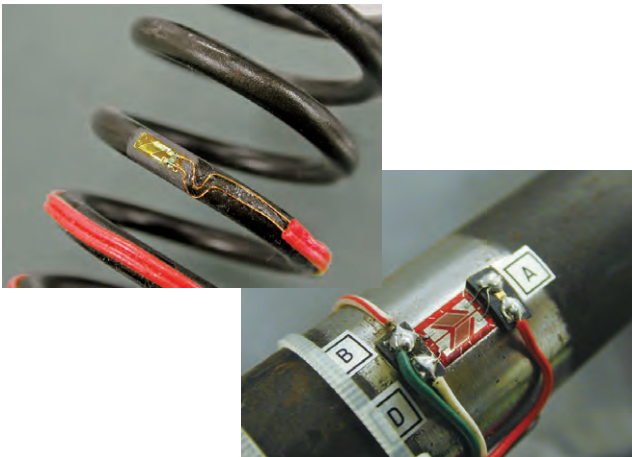

### Residual stress measurement

3-element residual stress measurement by center-hole drilling method

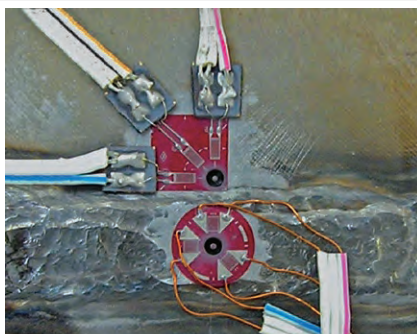

### Magnetic field use

Strain Gauge single element and twisted leadwire



Strain Gauge 0°/45°/90° 3-element and FEP twisted leadwire



Strain measurement less influenced by EM noise between pantograph and trolley wire of electrified railway system

Railway axle load measurement



### Concrete/Mortar measurements

Surface strain measurement of concrete and mortar

Strain Gauge with longer gauge length for concrete surface

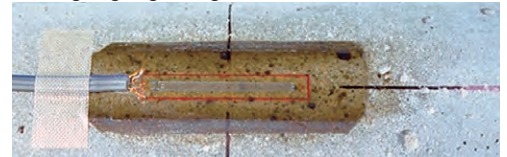

Strain Gauges with longer gauge length and metal backing for concrete surface



Internal strain measurement of concrete and mortar

Mold strain gauges

PMF series available with temperature sensor integrated



Internal strain measurement of concrete for long term



Full bridge Strain Transducer KM series

Before placement of concrete, 3 KM transducers are installed to reinforcing bars.



### Bolt tensile force by embedment type gauges

For measurement of tensile strain in a bolt. Simply inserted into a pre-drilled hole in the bolt head together with bonding adhesive. BTM and BTMC gauge series are recommendable if an ordinary strain gauge cannot be mounted on the bolt surface. Accurate tensile force measurement is possible by calibrating the bolt after installing the bolt gauges.



### Weldable strain gauges



### Frictional Strain Checker, Axial Strain Transducer, Torque Sensor System

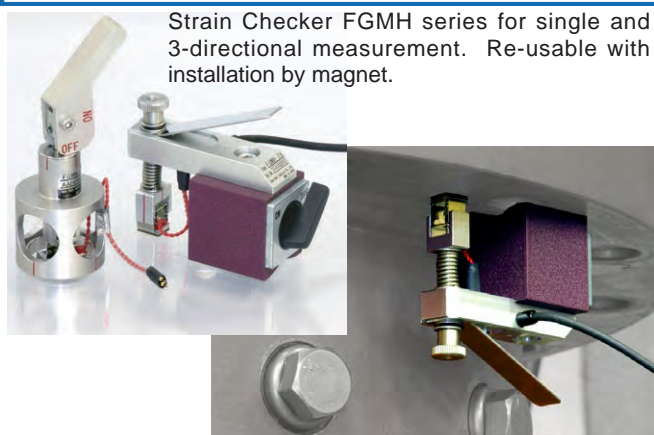

Strain Checker FGMH series for single and 3-directional measurement. Re-usable with installation by magnet.

Torque Sensor System FGDH series applicable to driving shaft with split and cover-up system. With built-in telemetry transmitter, no wiring is required.



### High Endurance Strain Gauge bonded on composite materials

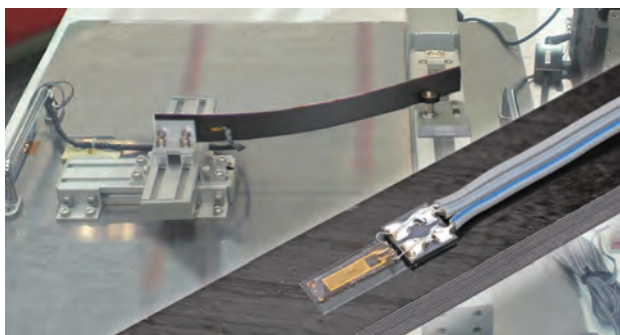

Composite materials on which High Endurance Strain Gauge DSF is bonded are demonstrated for fatigue test over  $10^7$  cycles at strain level of  $\pm 3,000$  microstrain.

Axial Strain Transducer FGAH series applicable to steering shaft with cover-up system. Different from the above FGDH, wire connection is required.



### Long term measurement

For construction measurement and maintenance.



### FBG Fiber-optic Strainmeter

Designed for Fiber Bragg Grating based strain gauges with optic fiber

- Temperature-compensation available with our FBG sensor
- No effect by EM noise
- Long distance measurement
- Fiber branching due to WDM techniques

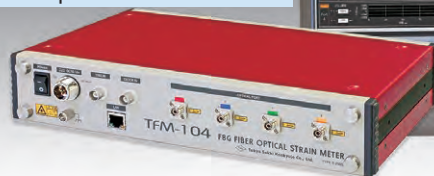



# STRAIN GAUGES GENERAL DESCRIPTION

Strain gauges are generally used for one of three reasons:

- To ascertain the amount of deformation caused by strain
- To ascertain the stress caused by strain and the degree of safety of a material or of a structural element that uses that material.
- To indirectly ascertain various physical quantities by converting them to strain.

There are a number of ways of measuring strain mechanically and electrically, but the vast majority of stress measurement is carried out using strain gauges due to their superior measurement characteristics.

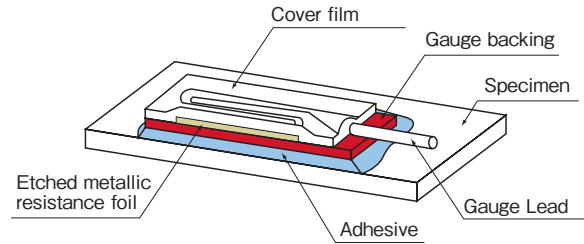

## What is Strain?

External force applied to an elastic material generates stress, which subsequently generates deformation in the material. At this time, the length of the material  $L$  extends to  $L+\Delta L$  if the applied force is a tensile force. The ratio of  $\Delta L$  to  $L$ , that is  $\Delta L/L$ , is called strain. On the other hand, if a compressive force is applied, the length  $L$  is reduced to  $L-\Delta L$ . Strain at this time is  $(-\Delta L/L)$ .

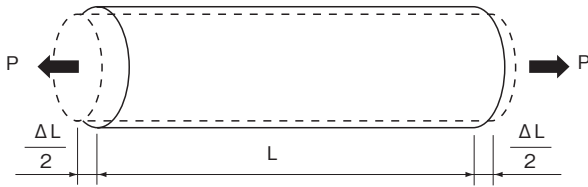

$$\varepsilon = \frac{\Delta L}{L} \quad \text{where} \quad \begin{array}{l} \varepsilon : \text{Strain} \\ L : \text{Original length of material} \\ \Delta L : \text{Change in length due to force P} \end{array}$$

Example) when a material of 100mm long deforms by 0.1mm in its length, the resulting strain is as follows.

$$\varepsilon = \frac{\Delta L}{L} = \frac{0.1}{100} = 0.001 = 1000 \times 10^{-6}$$

## What is a Strain Gauge?

The electric resistance of a metal changes proportionally to the mechanical deformation caused by an external force applied to the metal. By bonding a thin metal to a measurement object through a thin electrical insulator, the metal deforms depending on deformation of the measurement object and its electric resistance changes. The strain gauge (electric resistance strain gauge) is a sensor to measure the strain by means of measuring the resistance change.

## Strain Gauge Configuration

A strain gauge is constructed by forming a grid made of fine electric resistance wire or photographically etched metallic resistance foil on an electrical insulation base (backing), and attaching gauge leads.

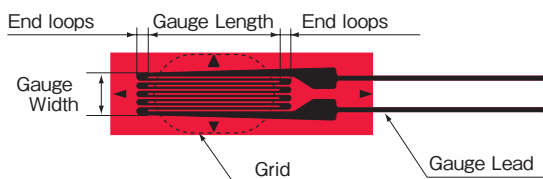

## Strain Gauge Principles

When strain is generated in a measurement object, the strain is transferred to the resistance wire or foil of the strain gauge via the gauge base (backing). As a result, the wire or foil experiences a resistance change. This change is exactly proportional to the strain as in the equation below.

$$\varepsilon = \frac{\Delta L}{L} = \frac{\Delta R/R}{K}$$

where  
 $\varepsilon$  : Strain measured  
 $L$  : Original length of material  
 $\Delta L$  : Change in length due to force P  
 $R$  : Gauge resistance  
 $\Delta R$  : Resistance change due to strain  
 $K$  : Gauge Factor as shown on package

Normally, this resistance change is very small and requires a Wheatstone bridge circuit to convert the small resistance change to a more easily measured voltage change.

The voltage output of the circuit is given as follows.

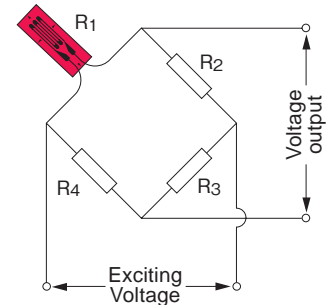

$$e = \frac{R_1 R_3 - R_2 R_4}{(R_1 + R_2)(R_3 + R_4)} E$$

where  
 $e$  : Voltage output  
 $E$  : Exciting voltage  
 $R_1$  : Gauge resistance  
 $R_2, R_3, R_4$  : Fixed resistance

Here, if  $R_1=R_2=R_3=R_4$  the resistance of the strain gauge changes to  $R+\Delta R$  due to strain. Thus, the output voltage  $\Delta e$  (variation) due to the strain is given as follows.

$$\Delta e = -\frac{\Delta R}{4R + 2\Delta R} E$$

When  $\Delta R \ll R$

$$\Delta e = -\frac{\Delta R}{4R} E = -\frac{E}{4} K \varepsilon$$

When measuring with a strain gauge, it is connected to an instrument called a strainmeter. The strainmeter configures a Wheatstone bridge circuit and supplies exciting voltage. Measured strain is indicated on a digital display and/or output as analog signals.



## Plane Stress and Strain

The stress in a material balanced with an applied external force can be considered a combination of more than one simple stress. In other words, these stresses can be divided into simple stress in the respective axial directions; however, measurement with ordinary strain gauges is restricted to the plane strain. In case that the stress exists in uniaxial direction like tension of a bar illustrated below, the following equation are applicable.

$$\epsilon_x = \frac{\sigma}{E}$$

$$\epsilon_y = -\nu\epsilon_x = -\frac{\nu\sigma}{E}$$

where

$\sigma$  : Stress  
 $E$  : Elastic modulus  
 $\epsilon_x$  : Strain in x direction  
 $\epsilon_y$  : Strain in y direction  
 $\nu$  : Poisson's ratio

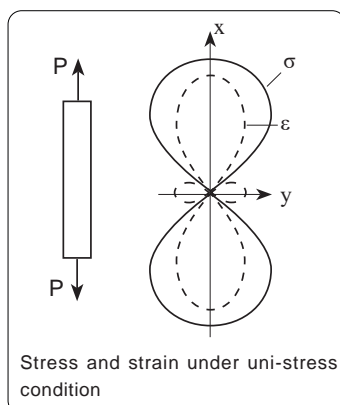

The biaxial stresses generated by pulling the bar in both normal and transversal directions are:

$$\epsilon_x = \epsilon_x' - \nu\epsilon_y'$$

$$= \frac{\sigma_x}{E} - \frac{\nu\sigma_y}{E}$$

$$= \frac{1}{E} (\sigma_x - \nu\sigma_y)$$

$$\epsilon_y = \epsilon_y' - \nu\epsilon_x'$$

$$= \frac{\sigma_y}{E} - \frac{\nu\sigma_x}{E}$$

$$= \frac{1}{E} (\sigma_y - \nu\sigma_x)$$

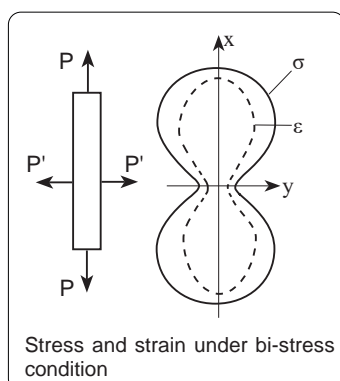

$\epsilon_x'$  : strain in the x direction due to  $\sigma_x$

$$\sigma_x = \frac{E}{1-\nu^2} (\epsilon_x + \nu\epsilon_y)$$

$\epsilon_y'$  : strain in the y direction due to  $\sigma_y$

$$\sigma_y = \frac{E}{1-\nu^2} (\epsilon_y + \nu\epsilon_x)$$

For the stress in other than the crossed biaxial directions, it is shown according to its angle as follows.

$$\sigma_n = \sigma_x \cos^2\theta + \sigma_y \sin^2\theta + \tau_{xy} \sin 2\theta$$

$$= \frac{1}{2}(\sigma_x + \sigma_y) + \frac{1}{2}(\sigma_x - \sigma_y) \cos 2\theta + \tau_{xy} \sin 2\theta$$

$$\tau = \frac{1}{2}(\sigma_x - \sigma_y) \sin 2\theta - \tau_{xy} \cos 2\theta$$

As noted from the above equations, in a certain direction, the maximum value of the resultant stress appears in the uniaxial direction. The axial direction is called a principal direction of stress and the stress in that direction a principal stress. In this direction, the shearing stress is zero. The maximum value of shearing stress is generated in the direction of 45° against the principal direction of stress. It can also be applied to the strain. The strain in such a direction is called a principal strain.

## Measurement of principal strain and stress using 3-element rectangular rosette gauge

When strain is generated in the surface of material and the principal direction of the strain and its extent are unknown, the principal strain, stress and their directions and shearing strain and stress can be obtained by measuring the strains in three directions over the surface. In order to simplify calculation, the relative angle in the three directions are determined as follows.

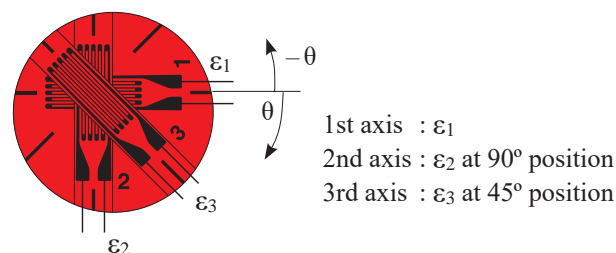

### Maximum principal strain

$$\epsilon_{\max} = \frac{1}{2} [\epsilon_1 + \epsilon_2 + \sqrt{2 \{(\epsilon_1 - \epsilon_3)^2 + (\epsilon_2 - \epsilon_3)^2\}}]$$

### Minimum principal strain

$$\epsilon_{\min} = \frac{1}{2} [\epsilon_1 + \epsilon_2 - \sqrt{2 \{(\epsilon_1 - \epsilon_3)^2 + (\epsilon_2 - \epsilon_3)^2\}}]$$

### Maximum shearing strain

$$\gamma_{\max} = \sqrt{2 \{(\epsilon_1 - \epsilon_3)^2 + (\epsilon_2 - \epsilon_3)^2\}}$$

### Angle from $\epsilon_1$ gauge to direction of principal strain

$$\theta = \frac{1}{2} \tan^{-1} \left\{ \frac{2\epsilon_3 - (\epsilon_1 + \epsilon_2)}{\epsilon_1 - \epsilon_2} \right\}$$

If  $\epsilon_1 > \epsilon_2$ , the angle to the maximum principal strain is rotated by  $\theta$  clockwise from the 1st axis, and the minimum principal strain is located at  $\theta + 90^\circ$ . If  $\epsilon_1 < \epsilon_2$ , the angle to the maximum principal strain is rotated by  $\theta + 90^\circ$  clockwise from the 1st axis, and the minimum principal strain is located at  $\theta$ .

### Maximum principal stress

$$\sigma_{\max} = \frac{E}{1-\nu^2} (\epsilon_{\max} + \nu\epsilon_{\min})$$

$$= \frac{E}{2} \left[ \frac{\epsilon_1 + \epsilon_2}{1-\nu} + \frac{1}{1+\nu} \sqrt{2 \{(\epsilon_1 - \epsilon_3)^2 + (\epsilon_2 - \epsilon_3)^2\}} \right]$$

### Minimum principal stress

$$\sigma_{\min} = \frac{E}{1-\nu^2} (\epsilon_{\min} + \nu\epsilon_{\max})$$

$$= \frac{E}{2} \left[ \frac{\epsilon_1 + \epsilon_2}{1-\nu} - \frac{1}{1+\nu} \sqrt{2 \{(\epsilon_1 - \epsilon_3)^2 + (\epsilon_2 - \epsilon_3)^2\}} \right]$$

### Maximum shearing stress

$$\tau_{\max} = \frac{E}{2(1+\nu)} \gamma_{\max}$$

$$= \frac{E}{2(1+\nu)} \sqrt{2 \{(\epsilon_1 - \epsilon_3)^2 + (\epsilon_2 - \epsilon_3)^2\}}$$

### ! note

The above rosette analysis equations are based on the 3-element strain gauge shown in the diagram. When the order of the axis numbers is different or when the gauge is not a 90° rosette gauge, different equations must be used. Check the axis numbers of applicable strain gauge before performing rosette analysis.



# TECHNICAL TERMS

## ●Gauge Length

This dimension represents the actual grid length in the sensitive direction.

## ●Gauge Resistance

The gauge resistance is the electrical resistance of an unbonded gauge at room temperature and subject to no external stress. The gauge resistance generally used is 120Ω but gauges are also produced with gauge resistance of 60Ω, 350Ω and 1000Ω. High-resistance gauges yield a high bridge output when high voltages are applied but they are also susceptible to noise. The majority of the strain gauges used in the production of transducers have a gauge resistance of 350Ω.

## ●Gauge Factor

The amount shown in the following equation is called the gauge factor. In this equation,  $\epsilon$  indicates the strain generated due to uniaxial stress in the direction of the strain gauge axis.  $\Delta R/R$  shows the ratio of resistance change due to strain  $\epsilon$ .

$$K = \frac{\Delta R/R}{\epsilon}$$

where  $K$  : Gauge Factor  
 $\epsilon$  : Mechanical strain  
 $R$  : Gauge Resistance  
 $\Delta R$  : Resistance change

## ●Longitudinal Sensitivity

Longitudinal sensitivity is very similar to the gauge factor and refers to the sensitivity of the gauge when no strain is applied in the direction perpendicular to the gauge axis.

## ●Transverse Sensitivity

The gauge also exhibits sensitivity in the direction perpendicular to the axial direction. The amount shown in the following equation due to the uniaxial strain ( $\epsilon_t$ ) in the direction perpendicular to the gauge axis, and the resistance variation generated thereby, is called transverse sensitivity ( $K_t$ ).

$$K_t = \frac{\Delta R/R}{\epsilon_t} \times 100$$

where  $K_t$  : Transverse Sensitivity  
 $\epsilon_t$  : Uniaxial strain perpendicular to the gauge axis

## ●Transverse Sensitivity Ratio

This refers to the ratio of transverse sensitivity to longitudinal sensitivity. This is usually 1% or less and does not usually pose a problem except in high-precision measurement or in locations with biaxial strain.

## ●Gauge Hysteresis

When a strain gauge is bonded to a test specimen and strain is applied, resistance change for identical strain in increase and decrease processes may differ. This difference is referred to as hysteresis. Gauge hysteresis varies depending on factors such as grid configuration, base material, adhesive and temperature.

## ●Thermal Hysteresis

Thermal hysteresis refers to hysteresis that occurs in the heating or cooling cycle such that the respective cycles do not pass through the same point. Thermal hysteresis poses an ongoing problem in strain measurement where temperature change occurs. This hysteresis must be removed by applying heat treatment to stabilize the characteristic of the strain gauge and the adhesive.

## ●Gauge Zero Drift with Temperature

At high temperature, effects such as thermal oxidation of the sensing elements in a strain gauge cause the zero point of the gauge in a no-load state to gradually drift. This is one of the characteristics that determine a strain gauge's resistance to heat. Above 200°C, Ni-Cr alloy performs far better than Cu-Ni alloy, and alloys such as Pt-W are used in 500°C to 800°C environments.

## ●Self Temperature Compensated Gauge

A change in the ambient temperature may cause a variation of strain gauge resistance. The variation is ascribable to the thermal expansion of both strain gauge material and specimen, together with the thermal coefficient of resistance of the gauge material. Self-temperature compensated gauges are commonly used to minimize the gauge thermal output when bonded to test specimens having a specific linear thermal expansion coefficient in the specified temperature range. The following graph shows an example of thermal output.

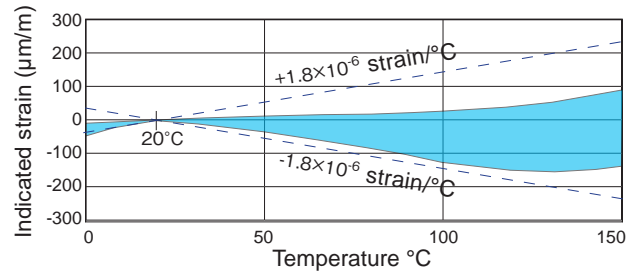

## ●Temperature Compensation Range

This refers to a temperature range in which the thermal output of a self-temperature compensated gauge should be within the given range. Compensation is accurate within approximately  $\pm 1.8 \times 10^{-6}$  strain/°C. For greater accuracy, corrections can be made using the curves for apparent strain vs. temperature which is supplied with each package of gauge.

## ●Operating Temperature Range

This range is the temperature range within which a strain gauge can be used continuously under appropriate conditions. The figure below shows thermal output characteristics for Cu-Ni and Ni-Cr alloys used for the sensing elements in TML strain gauges. Most strain gauges use Cu-Ni alloy, while Ni-Cr alloy is used in strain gauge series that have a wider operating temperature range.

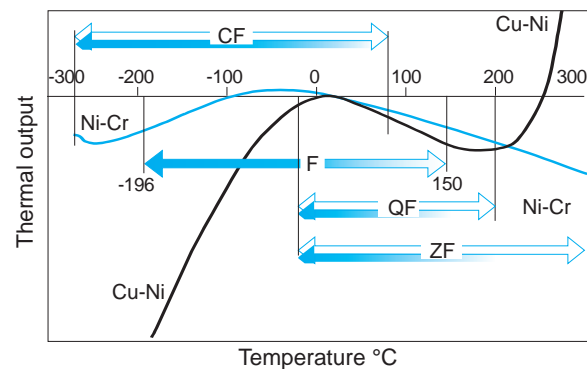

## ●Gauge Length Selection

Different gauge lengths should be selected depending on specimens. Gauges with short gauge lengths are used to measure local strain, while gauges with long lengths can be used to measure averaged strain over a larger area. For a heterogeneous material, a gauge length is required that can average out irregular strain in the material. For example, as concrete is composed of cement and aggregate (gravel or sand, etc.) the length of a gauge used is more than three times the diameter of the aggregate so as to give an averaged evaluation of the concrete.

Gauge length (mm)	Gauge Applications
0.2 - 1	For stress concentration measurement
2 - 6	For metal and general use
10 - 20	For mortar, wood, FRP, etc.
30 - 120	For concrete

### ● Strain Limit

The strain limit is the maximum amount of strain under which a strain gauge can operate under a given condition without suffering damage. At TML, the strain limit is the smallest value of mechanical strain at which the indicated strain exceeds the mechanical strain by 10%.

General use strain gauge  
F series : FLA-5-11

Post-Yield strain gauge  
YF series : YFLA-5

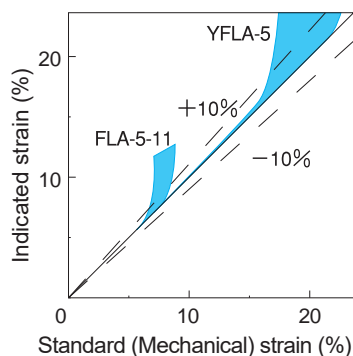

### ● Fatigue Life

When strain is applied repeatedly to a strain gauge, as the amount of strain becomes large, the gauge resistance increases and disconnection or peeling-off of the gauge occurs to make the gauge useless. In general, the fatigue life is determined by the amount of applied strain and speed of cyclic loading and expressed by the number of repetitions. At our company, a constant mechanical strain is applied repeatedly to the bonded strain gauge and the fatigue life is indicated by the number of repetitions at which the indicated strain value without load exceeds  $100 \times 10^{-6}$  strain. A typical calibration result is shown below. Even if the number of repetitions exceeds the specified life, the gauges will not necessarily fail. The fatigue life of most of our strain gauges under a cyclic strain of  $\pm 1,500 \times 10^{-6}$  strain is between  $10^6$  and  $10^7$  cycles. Under cyclic strain of less than 500, the fatigue life of most gauges is infinite. Post-yield strain gauges should not be subjected to cycle loading in elastic range as well as in large strain range.

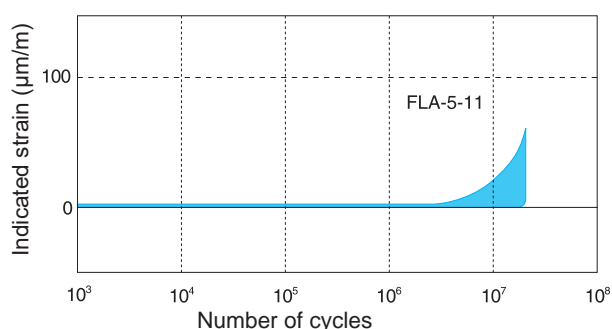

### ● Permissible Current (Permissible Voltage)

The current flowing in a strain gauge is related to the output voltage of the gauge bridge, and the larger the current, the larger the voltage is obtained. However, depending upon the material of a specimen and the area of the gauge, Joule's heat is generated by the current to raise the temperature of gauge and as a result apparent strains are produced. In general, a current less than 30mA is recommended for metallic specimens and less than 10mA for wooden and plastic specimens which dissipate heat less efficiently.

### ● Strain Gauge Frequency Response

The frequency response of a strain gauge is determined by the gauge length and the longitudinal elastic wave speed of the test specimen. Frequency response limits are typically only a concern under impact conditions.

Gauge length (mm)	0.2	1	3	5	10	30	60
Steel [kHz]	660	530	360	270	170	-	-
Concrete [kHz]	-	-	-	-	120	50	20

### ● Gauge Creep

A bonded strain gauge subjected to a constant strain will give a decreasing indicated value as time progresses. This phenomenon is referred to as creep. In general, the shorter the gauge length, the greater the gauge creep becomes. Also, this tendency exhibits well if the strain gauge or adhesive absorbs moisture.

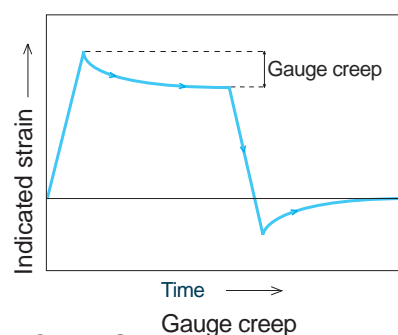

### ● Strain Gauge Shape

TML also supplies strain gauge in different patterns for a range of applications. Select the appropriate gauge patterns for your application.

Qty. of axis	1	2	2
Gauge Pattern			
Nomenclature	Single axis	0°/90° 2-axis	0°/90° 2-axis
Grid layout	—	Stacked type	Plane type
Qty. of axis	3	3	5
Gauge Pattern			
Nomenclature	0°/45°/90° 3-axis	0°/45°/90° 3-axis	5-element Single-axis
Grid layout	Stacked type	Plane type	—



# Temperature compensation for leadwires in Quarter bridge

For strain gauge measurement, the Wheatstone bridge circuit is used to convert resistance change of the strain gauge into voltage output. The simplest bridge method is a quarter bridge, where one arm is composed of the strain gauge while the other three arms are composed of fixed resistors in the instrument. A 2-wire leadwire may be used for connecting the strain gauge to the instrument. However, if the temperature of the leadwire changes, thermal output of the bridge is caused even if there is no change in actual strain. For this reason, the quarter bridge 2-wire method should be used only when temperature change is not expected during the measurement or for a dynamic measurement in which the thermal output can be disregarded. A quarter bridge 3-wire method is available as a mean to eliminate the thermal output of the leadwire, when a 3-wire leadwire is used for connection of the strain gauge. In this method, the influence of resistance change of the leadwire caused by temperature change is cancelled. In addition, the effect of the leadwire on gauge factor is half as large as that of the quarter bridge 2-wire method. The quarter bridge 3-wire method is recommended over the 2-wire method, especially when temperature change is expected during the measurement and/or comparatively long leadwires are used.

Other bridge methods including half bridge and full bridge are also available. Refer to p.17~18 for details.

**Strain Gauge and leadwire connection**

Bridge Circuit	Connection
Quarter bridge with 2-wire	
Quarter bridge with 3-wire	

## ● Thermal output caused by temperature change

In a quarter bridge 2-wire method, changes in leadwire temperature cause changes in the leadwire resistance, which result in thermal output. Use the equation below to compensate for this thermal output.

$$\text{Leadwire thermal output } \varepsilon L = \frac{r \cdot L \cdot \alpha \cdot \Delta T}{K \cdot (R + r \cdot L)}$$

where

- $\varepsilon L$  : Leadwire thermal output
- $K$  : Gauge factor indicated on the strain gauge package
- $\alpha$  : Thermal coefficient of resistance of leadwire ( $3.9 \times 10^{-3}/^{\circ}\text{C}$  for copper)
- $r$  : Total resistance of leadwire per 1 meter ( $\Omega/\text{m}$ )
- $L$  : Leadwire length (m)
- $\Delta T$  : Temperature change of leadwire ( $^{\circ}\text{C}$ )

Note)

- Compensation is possible on condition that the temperature change is uniform for whole length of the leadwire.
- In a quarter bridge 3-wire method, compensation is not necessary because the influence of change in leadwire resistance caused by temperature change is cancelled.
- Also our 1-Gauge 4-Wire Strain measurement method does not require above correction because it is not influenced at all by the leadwire resistance. Refer to following page for details.

## ● Gauge Factor (Gauge sensitivity) correction for leadwire connection

The leadwire resistance between the strain gauge and strainmeter noticeably lowers the gauge factor. Calculation for the correction is required depending on the measurement method and on the leadwire type and length.

Quarter Bridge with 2-wire	Quarter Bridge with 3-wire
Correction coefficient of leadwire : A $A = \frac{R}{R + rL}$ Corrected Gauge Factor : $K_0$ $K_0 = \frac{R}{R + rL} \quad K = A \cdot K$	Correction coefficient of leadwire : A $A = \frac{R}{R + \frac{rL}{2}}$ Corrected Gauge Factor : $K_0$ $K_0 = \frac{R}{R + \frac{rL}{2}} \quad K = A \cdot K$
where R : Nominal gauge resistance in $\Omega$ r : Total resistance per meter of leadwire ( $\Omega/\text{m}$ ) K : Gauge Factor shown on package L : Length of leadwire in meter	

## ● Total resistance per meter of our typical pre-attached leadwire

In strain gauge, the leadwire resistance produces a deterioration of gauge sensitivity and thermal drift. The leadwire should be as thick and as short as possible.

### Twisted leadwire

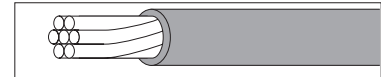

Number of cores / Diameter (mm)	7/0.12	10/0.12	7/0.16	7/0.18	12/0.18	20/0.18
Cross section area of lead wire ( $\text{mm}^2$ )	0.08	0.11	0.14	0.18	0.3	0.5
Total resistance of leadwire per meter ( $\Omega$ )	0.44	0.32	0.24	0.20	0.12	0.07

### Single-core leadwire

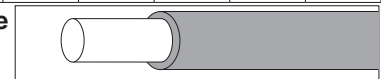

Construction	Polyimide wire (0.14mm-dia.)	Polyimide wire (0.18mm-dia.)
Cross section area of leadwire	0.015 $\text{mm}^2$	0.025 $\text{mm}^2$
Total resistance of leadwire per meter	2.5 $\Omega$	1.5 $\Omega$

## ¶ Setting the Gauge Factor to Data Loggers\*

$$Cs = \frac{2.00}{K_0} \quad \begin{array}{l} Cs : \text{Coefficient set} \\ K_0 : \text{Gauge Factor corrected with leadwire attached} \end{array}$$

For the detail of Data Loggers, refer to page 95.



# Complete Compensation Method of Strain with Wheatstone Bridge - COMET

COMET: Abbreviation of Complete Compensation Method of Strain

When measuring strain using a strain gauge, quarter bridge method is commonly used. Quarter bridge 2-wire method is the easiest for strain measurement, while quarter bridge 3-wire method has an advantage of eliminating thermal output caused by the temperature change of the lead wire. It is known that there may be some small errors in measured values obtained by these methods, which are caused by initial unbalance and non-linearity of the bridge circuit. Most of our strainmeters already have a function of correcting non-linearity of quarter bridge circuit. However, if we look into the matter more closely, this function is not enough to completely correct the measured values, for example when the initial unbalance of the bridge is significant. Our unique technique "Complete Compensation Method of Strain" is a method which is capable of fully correcting the errors in measured values obtained by quarter bridge method without being influenced by initial unbalance and non-linearity of the bridge circuit. This method is available in our instruments listed below.

### Data loggers

TS-960, TS-560, TDS-630, TDS-540, TDS-530\*, TDS-602\*, TDS-303\*, TDS-150, TDS-102\*, TC-31K\*, TC-32K  
\*: No longer in production

### Measurement error is not caused by initial unbalance of bridge

If the resistance of strain gauge and bridge completion resistors is not exactly the same when the strain is zero, an output voltage is yielded. This should more or less occur in actual bridge circuits. The output voltage is treated as an initial unbalance and deducted from the output voltage when strain is applied. However, it causes some error in measured strain values. This error becomes zero by using the Complete Compensation Method of Strain. It is especially effective in cases as follows, in which a large initial unbalance is expected.

- The leadwire is extended during the measurement.
- The strain gauge is mounted on a curved surface.
- Strain gauges having uneven resistance are used.
- Temperature change is large during the measurement.

### Non-linearity error of bridge circuit is completely corrected

The relation between the output voltage of bridge circuit and the strain is not exactly linear. Non-linearity error becomes larger with increase of strain. Conventional method for correcting the non-linearity is based on condition that the initial unbalance of bridge is zero. The Complete Compensation Method of Strain works to correct the non-linearity error even when the initial unbalance of bridge is large. It is also effective in the following cases in addition to the cases mentioned in former clause.

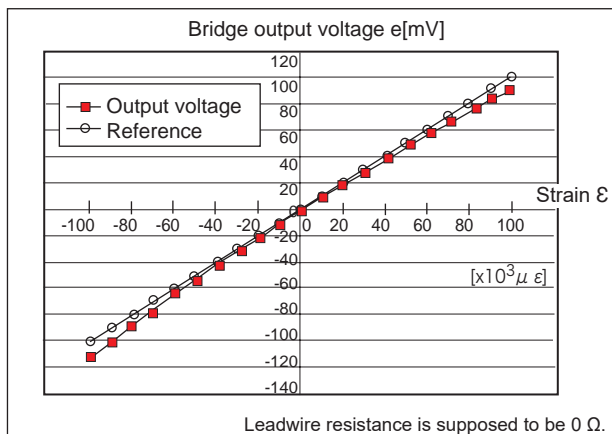

- Strain gauge is replaced with a new one when measuring large strain.
- Initial unbalance is readjusted during the measurement.

### Descent of sensitivity caused by the leadwire resistance is corrected

The strain gauge sensitivity is influenced by the resistance of the leadwire. In quarter bridge 3-wire method, the lead-wire resistance is measured and the sensitivity is corrected automatically by using a data logger having the Complete Compensation Method of Strain. When measuring multiple points of strain gauges, it is not necessary to use lead wires of the same length for the purpose of simplifying the correction calculation.

### Complete Correction of thermal output of strain gauge

Thermal output of strain gauge is given as data under no strain, and it may somewhat differ under strained condition. The Complete Compensation Method of Strain compensates thermal output by taking the applied strain into consideration. This is especially effective when the thermal output is large.  
(This compensation is available in TDS-630.)

### Correction of error caused by replacement of strain gauge

When measuring a large strain, it is a common practice to replace the strain gauge with a new one when the strain comes close to strain limit of the strain gauge. In this case, accurate strain after the replacement can be known by correcting the measured values referring to the strain value at the time of replacement. The Complete Compensation Method of Strain makes this correction automatically.

### Setting of true strain measurement (COMET)

This is the setting for performing a measurement correcting the error of strain value using the function called "COMET".

When the sensor mode is quarter bridge 3-wire method, the measurement value is displayed

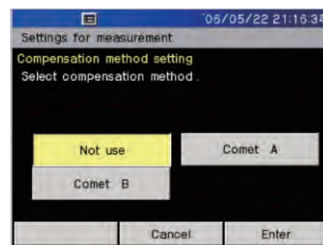

by implementing non-linear correction even if [Not use] is selected. By selecting Comet, it is possible to obtain more correct strain value. Half bridge common dummy can be used only for Comet A.

### COMET A

This is the correction method to correct the non-linearity error by initial unbalance of the bridge, and this is effective when the initial unbalance value is large. The bridge output voltage  $e_0$  is measured at initial in and memorized internally. The bridge output voltage  $e$  when the strain is generated is calculated when the measurement is performed, and the correction calculation below is implemented.

$$\epsilon_m = \frac{e - e_0}{(1-e) \times (1+e_0)}$$

### COMET B (Quarter bridge 3-wire method only)

This is used when correcting the descent of sensitivity by leadwire at the same time as the correction method of Comet A.

The bridge output voltage  $e_0$  at initial unbalance and both-ends voltage of lead wire resistance  $e_r$  are measured at initial in, and memorized internally. The bridge output voltage  $e$  when the strain is generated is measured at the measurement, and the calculation below is implemented.

$$\epsilon_m = \frac{e - e_0}{(1-e) \times (1+e_0 - e_r)}$$

When Comet B calculation is implemented, the correction calculation that includes initial unbalance value that is recorded at initial in and both-ends voltage of leadwire resistance is implemented from the formula above, so only the measure measurement is available. Be sure to perform the measurement after implementing the initial in at the initial unbalanced status for starting measurement.



# Application example of Complete Compensation Method of Strain

Measurements using our data loggers equipped with Complete Compensation Method of Strain have the advantages of the followings.

- Complete compensation of non-linearity
- No influence of strain gauge resistance
- No influence of dummy resistance
- No need of using leadwires of the same length saving costs and space for unnecessary leadwires
- No need of correcting sensitivity change caused by leadwire resistance

Accurate strain measurement is possible owing to the features above. Furthermore, measurements as in the following examples become possible by the use of Complete Compensation Method of Strain.

## Application example 1:

### Compensation of thermal output when using a temperature-integrated strain gauge

Thermal output of strain gauge is automatically compensated when measuring a temperature-integrated strain gauge with data logger TDS-630. A polynomial representing the thermal output is attached to each strain gauge, and coefficients of the polynomial are input to TDS-630 before starting the measurement. Thermal output of the strain gauge caused by the change of environmental temperature is calculated and corrected by the TDS-630 with better accuracy than conventional method.

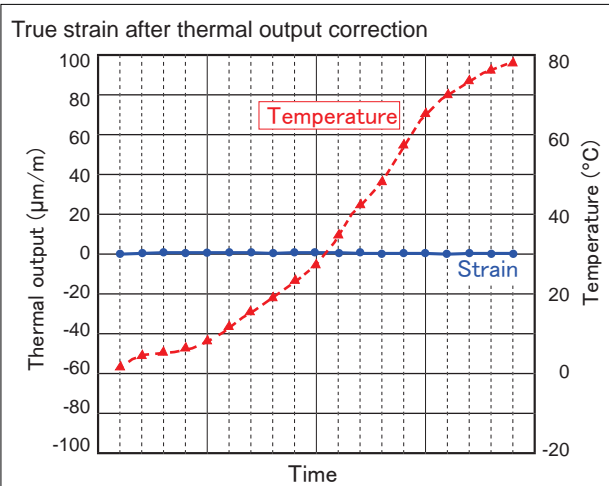
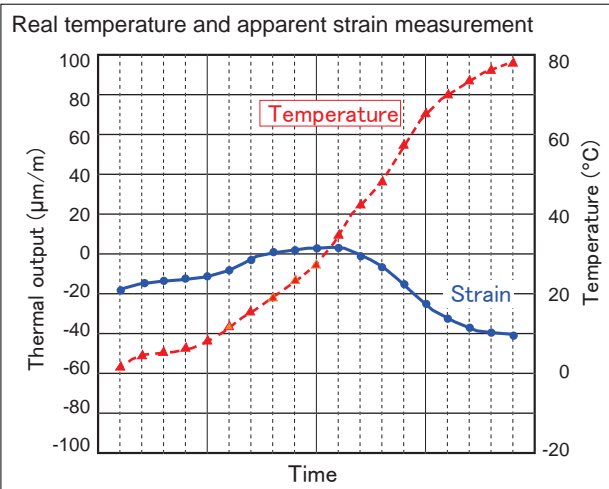

## Application example 2:

### Measurement of stress concentration gauge CCFXX, CCFYX

The CCFXX and CCFYX are newly developed strain gauges having 10 grids aligned continuously without interval between each adjoining grids. Different from the conventional stress concentration gauge having individual grids aligned with small intervals, it can measure strain distribution of the specimen more precisely. This strain gauge should be measured using our data logger with Complete Compensation Method of Strain. The number of leadwires is reduced to 11.

CCFXX

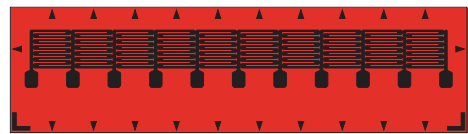

### Measurement example

Strain caused by depression of bolt head (M10)

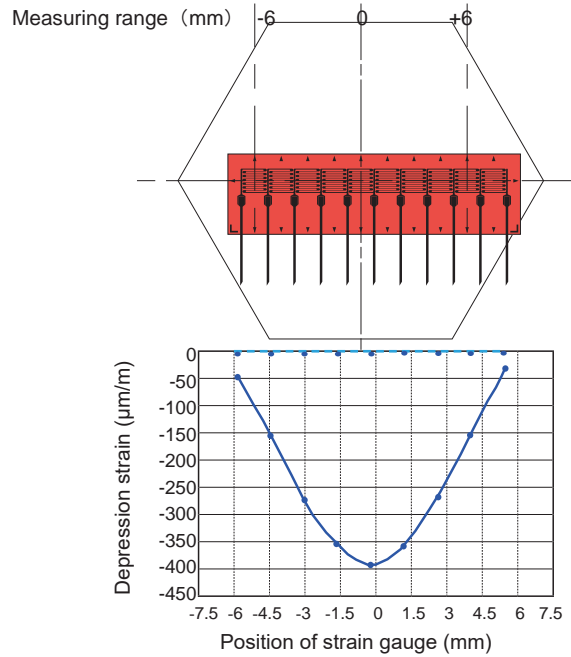

Axial strain (µm/m)

- - - - 0
- - - - 1000

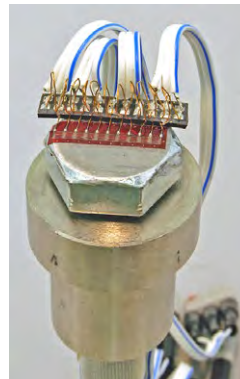

The number of leadwires is 30 which is required for measuring a conventional 10-element strain gauge with quarter bridge 3-wire method. The number is reduced to 11 in CCFXX/CCFYX strain gauge. This is achieved by using one leadwire for measurement of two or three grids. The adjacent grid is connected in series with one leadwire of 3-wire connection. The resistance of this adjacent grid can be ignored by using our data logger with Complete Compensation Method of Strain.



# 1-gauge 4-wire strain measurement method

## Abstract

When measuring strain gauges, various connection methods are available according to the number of strain gauges used and the purpose of measurement. In quarter bridge method, 3-wire connection is widely used to remove the effect of temperature change in the resistance of the strain gauge leadwire. However in the method, gauge factor correction is required depending on the leadwire resistance. In addition, some measurement error may be caused by the contact resistance in the connection part such as between the strain gauge leadwire and the instrument terminal. The 1-gauge 4-wire strain measurement is our unique method which eliminates the need of gauge factor correction depending on the leadwire resistance and the measurement error caused by the contact resistance.

Since a new leadwire and a simple connector (modular plug) can be used, it helps to streamline the wiring works and to prevent wiring mistakes, and also to reduce the cost of strain measurement by reusing the leadwires. Furthermore, since soldering works are not necessary, it can save wiring materials and realize lead-free connections.

## Advantage over quarter bridge 3-wire method

### ●Leadwire resistance

In the conventional method, leadwires as thick and short as possible are recommended to keep the resistance of the leadwire as small as possible. However, since there is no influence of the leadwire resistance in 1-gauge 4-wire method, it is possible to use thin and/or long leadwires for connecting strain gauges.

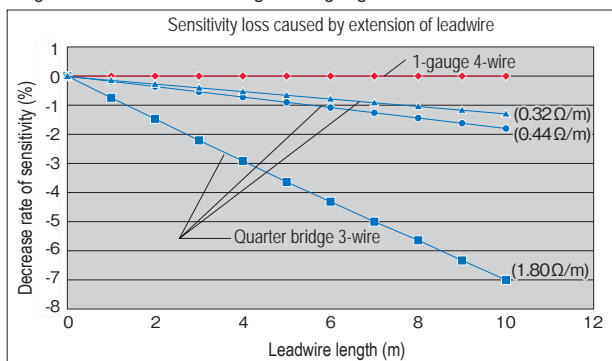

Comparison of strain measurement method between Quarter bridge 3-wire and 1-gauge 4-wire  
Advantage of not being affected by leadwire resistance

	Quarter bridge 3-wire (Wheatstone bridge circuit)	1-gauge 4-wire strain measurement method
Thickness of leadwire	Thick	Thin
Weight of leadwire	Heavy	Light
Material of leadwire	The same material must be used	No need of using the same material
Sheath color of leadwire	Must be the same color depending on the measurement	No need of using the same color
Load on the specimen	Heavy	Light
Transportation cost	High	Low

### ●Not influenced by thermal output of leadwire

When a 10 meter long leadwire having cross sectional area of  $0.11\text{mm}^2$  is used for measurement of  $120\ \Omega$  strain gauge in quarter bridge (2-wire) method, thermal output of about  $50 \times 10^{-6}$  strain/ $^{\circ}\text{C}$  will be resulted if there is a temperature change during the measurement. Therefore, compensation is necessary. Even if the quarter bridge 3-wire method is used, compensation is necessary when the type, length, cross sectional area, or temperature environment of the three wires is not the same. In 1-gauge 4-wire strain measurement method, compensation is not necessary even under such conditions.

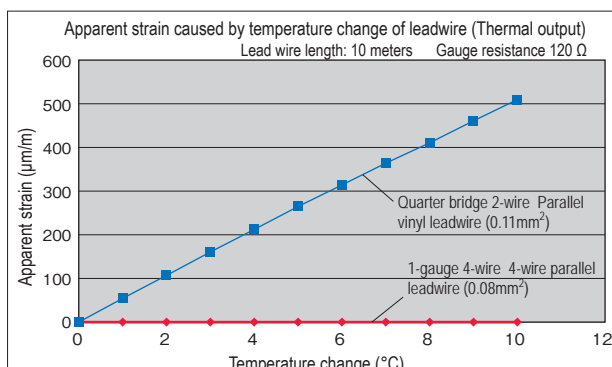

### ●Contact resistance

Conventionally, leadwire extension and connection to a measuring instrument are done by soldering or by the use of specially designed connectors in order to eliminate the influence of contact resistance. Since the 1-gauge 4-wire method is not affected at all by contact resistance, a modular plug which is installed by crimping can be used. The modular plug makes easy connection of the leadwire to an instrument or to an extension leadwire, and efficient connection works without wiring mistakes become possible. Furthermore, since soldering is not necessary, lead-free connection is actualized.

Comparison of strain measurement method between Quarter bridge 3-wire and 1-gauge 4-wire  
Advantage of not being affected by the variation of contact resistance at the connection point

	Quarter bridge 3-wire (Wheatstone bridge circuit)	1-gauge 4-wire strain measurement method
Connection using easy connector	Not possible	Possible
Soldering	Necessary (for long-term measurement) For short-term measurement, screwing is possible	Not necessary
Time required for wiring works	Long	Short
Wiring mistakes	Care must be taken	Largely decreased

## Strain gauge with leadwire and modular plug

This is a strain gauge applicable to our newly developed 1-gauge 4-wire strain measurement method. Most of our strain gauges can be supplied with the exclusive leadwire and the modular plug (RJ12) pre-attached. Because the modular plug is attached to the end of the leadwire, neither soldering nor screwing is necessary when connecting the strain gauge to a measuring instrument. The strain gauge is connected by simply inserting the modular plug into the modular connector receptacle which is equipped in data logger TDS-630, TDS-540 (with option), TDS-150 and TC-32K, and switching box IHW-50H, IHW-50G, ISW-50G, SSW-50D and FSW-10. The sheath of the 4-wire leadwire is made of polypropylene, which does not generate noxious gas even if exposed to fire. A vinyl sheathed leadwire is also available at a lower cost.

Easy leadwire extension using modular connectors

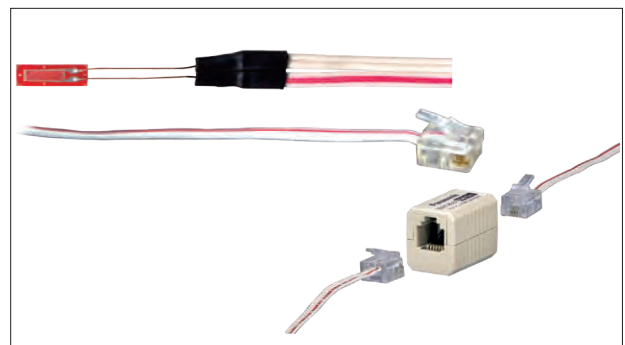



# 1-gauge 4-wire strain measurement method

## Measurement principle

The 1-gauge 4-wire strain measurement method uses a simple series circuit which is composed of a resistance of strain gauge ( $R$ ) and a reference resistance ( $R_s$ ) to measure strain. The voltage ( $E$ ) is applied to the both ends of the series circuit to flow the current ( $i$ ). The strain is obtained from the voltage ( $V$ ) generated by the strain gauge resistance and the voltage ( $V_s$ ) generated by the reference resistance. As the path where the current flows and the path where the voltage is measured are different, measurement is possible without being affected by the leadwire resistance or the contact resistance ( $r$ ).

where

- $R$  : Gauge resistance
- $R_s$  : Reference resistance
- $r_1 \sim r_4$  : Leadwire resistance and contact resistance
- $i$  : Current flowing in strain gauge resistance and reference resistance
- $E$  : Excitation voltage
- $V$  : Voltage generated by gauge resistance
- $V_s$  : Voltage generated by reference resistance

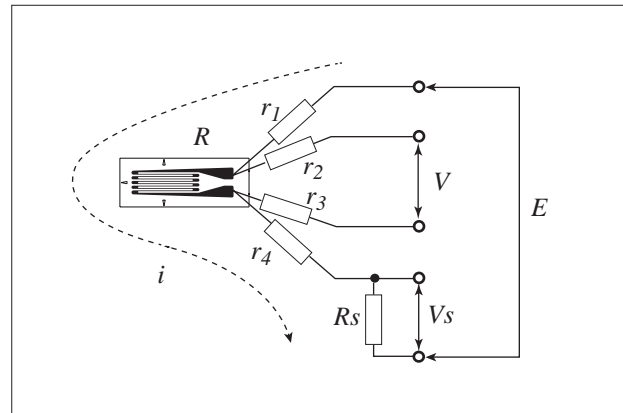

## Connection / Applicable instruments

The 1-gauge 4-wire method is a new strain measurement method that does not need gauge factor correction for the leadwire resistance and does not cause measurement error by the contact resistance. In addition, the method can remove the initial unbalance caused by the leadwire resistance and also can remove the influence of leadwire resistance change caused by the temperature change. While the use of a leadwire as thick and short as possible is recommended for quarter bridge 3-wire method, a thin leadwire and/or connectors for connection and extension of the leadwire can be used for 1-gauge 4-wire method. Correction of the measured values is not necessary even if leadwires of various types and/or of different length for each strain gauge are used.

The 1-gauge 4-wire strain measurement method is available only by the data loggers and switching boxes made by our company.

1-gauge 4-wire strain gauge with modular plug

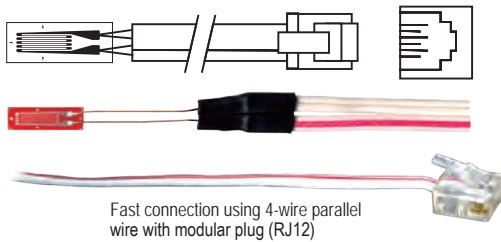

4-core shielded cable is connected directly if a modular plug is not used

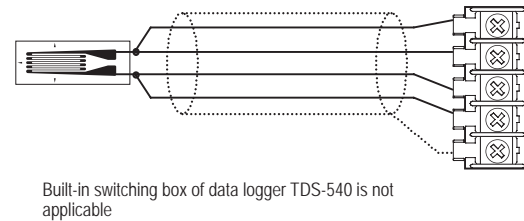

The exclusive leadwire with modular plug (RJ12) can be attached to most of our strain gauges. It enables efficient wiring works without mistakes. The leadwires can be used repeatedly to reduce the cost of the measurement.

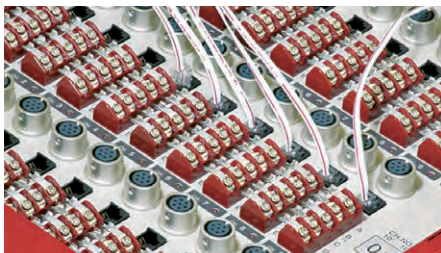

Applicable sensor mode  
 1G4W 120Ω Gauge resistance 120 Ω  
 1G4W 240Ω Gauge resistance 240 Ω  
 1G4W 350Ω Gauge resistance 350 Ω

Applicable instruments

Data logger TDS-540(with option)/TS-560 /TDS-630/TDS-150/TC-32K

1-gauge 4-wire strain measurement is possible by fast connection to the modular jack of the switching box

Switching box IHW-50H/IHW-50G/ISW-50G/SSW-50D/FSW-10

Fast connection to the modular jack provided to the built-in switching box of data logger or the switching box

### ● 3-element rosette strain gauge (shrinkable tube type)

This is a 3-element rosette strain gauge having a 4-wire parallel leadwire with modular plug attached to each element in 1-gauge 4-wire connection. Fast connection of the leadwires are possible to each channel of a data logger or switching box for static strain measurement. Note: This strain gauge is not applicable to dynamic strain meters.

- 3-element 0° /45° /90° stacked type
- Used leadwire
- 0.08mm<sup>2</sup> vinyl sheathed leadwire with modular plug
- Applicable temperature -20~+80° C
- FRA-2-11-○LQM (modular plug 4-wire RJ12 6-4)
- shows the lead wire length in meter





# Measuring Method of Strain and Temperature

Temperature measurement is necessary for strain measurement involving temperature change. In addition to the thermocouples and platinum RTDs which are generally used for measuring temperature, our product line includes temperature gauges which may be used in a same way as strain gauges, and temperature integrated strain gauges which are capable of measuring strain and temperature simultaneously. We will provide you with the introduction of their features and applications.

## Temperature measurement applications to our strain measuring instruments

Temperature measurement means	Application to static strain measuring instruments	Application to dynamic strain measuring instruments	Temperature measurement range (°C)	Features
Thermocouple (T, K, etc.)	Applicable	Applicable	-269 ~ +1760	Wide temperature range
Platinum RTD Pt100	Applicable	Not applicable	-40 ~ +400	High accuracy. Can be used only with data loggers
Temperature integrated strain gauges	Applicable	Not applicable	-20 ~ +200	Applicable to most of the foil strain gauges
Temperature gauges TF Series	Applicable	Applicable	-20 ~ +200	A dedicated adapter necessary
Temperature gauge. KT-110A	Applicable	Applicable	-30 ~ +80	Robust structure, mainly for civil engineering

## THERMOCOUPLE

Wide range of temperature can be measured by selecting the types of thermocouple wire and sheath material. In this catalog, the following sheath material for thermocouples are introduced (the temperatures indicated are upper temperature limits):

Vinyl: 80 °C

Fluorinated resin: 200 °C

Glass fiber : 350 °C

See page 76 for the details of thermocouples.

By using static strain measuring instruments such as data logger TDS series and TC-32K, temperature measurement using various thermocouples can be carried out. As for DC dynamic strain measuring instrument DC-96A/DC-97A, DC-204R, DC-004P, DH-14A, TMR-300 and DS-50A, temperature measurement can be carried out by thermocouples K and T through Dedicated unit or thermocouple adapter TA-01KT.

## PLATINUM RTD

Temperature measurement can be carried out by bonding the platinum RTD to the surface of an object to be measured, just like when using strain gauges. The measurement accuracy is high, and the measurement can be done by connecting to lead wires for strain gauges. Platinum RTD

is connected to static strain measuring instruments such as data logger TDS series or TC-32K when measuring. Platinum RTD is not applicable to dynamic strain measuring instruments.

## TEMPERATURE-INTEGRATED STRAIN GAUGES

Temperature measurement function can be mounted to almost any foil strain gauge. (See the chart in pages 39 and 40 for combination of strain gauges and dedicated lead wires.) The temperature measurement point is the tab of a strain gauge, so the temperature shown is as same as the temperature of the strain gauge. The temperature can be measured using our data logger.

The applicable lead wires with temperature measuring function are as follows:

- Single core 3-wire twisted fluorinated resin (FEP) lead wire 6FB\_TLT  
Applicable temperature: -269 °C ~ +200 °C
- 3-wire paralleled vinyl lead wire -TLJBT/-TLJBT-F  
Applicable temperature: -20 °C ~ +80 °C
- 4-wire paralleled vinyl lead wire TLQ  
Applicable temperature: -20 °C ~ +80 °C

(See page 34 for details of lead wires.)

If you wish to mount the temperature measuring function on the strain gauge of your choice, insert a "T" after the number indicating the length of the gauge, and then designate the length and type of the lead wire. For example, if you want to add temperature measuring function and a 3 meters vinyl lead wire to FLA-2-11, the type name should be written as:

FLA-2 T -11 -3 TLJBT

└─ 3-wire paralleled vinyl lead wire TLJBT  
└─ Desired length of the lead wire: 3m  
└─ With temperature measuring function

Temperature integrated strain gauges are not applicable to measurements by dynamic strain measuring instruments.

## Wire connection methods

1. For TDS-630/-540/-530

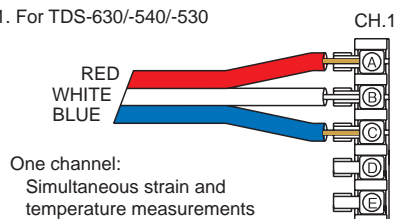

2. For other applicable measuring instruments: TDS-302/-303/-601/-601A/-602/-101R/-150/-102/-300

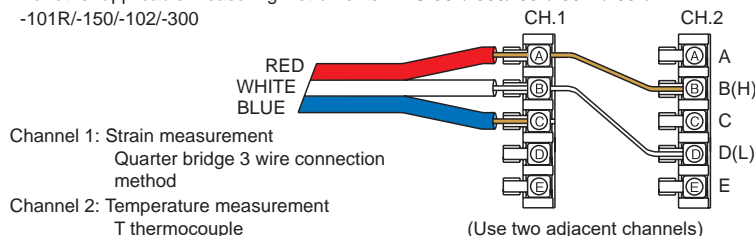

## TEMPERATURE GAUGES TF SERIES

Temperature gauge TF series is used for measuring surface temperature by bonding it to the surface of structural object just like strain gauges. By using adapter TGA for temperature gauge and strain measuring instrument

in combination, the measurement will be performed and represented in the unit of  $100 \times 10^{-6} / ^\circ\text{C}$ . See page 76 for details of TF series and adapter TGA.

## TEMPERATURE GAUGES KT-110A

KT-110A is a temperature sensor using full bridge method. It is used in civil engineering and construction sites for its robustness. KT-110A can carry out measurement as temperature sensor using full bridge method

(also used by transducers) by using strain measuring instruments. Consult us for details of KT-110A.



# STRAIN GAUGE BRIDGE CIRCUIT

## STRAIN GAUGE BRIDGE CIRCUIT

Connection diagram varies according to strainmeter type.

Measuring mode	Bridge circuit	Wiring connection to		Bridge Output
		Switching Box	Bridge Box	
Quarter bridge (with 2-wire) 		<p>Terminal code E D C B A</p>	<p>short-circuited</p>	$E$ : Excitation voltage $e$ : Output voltage $\Delta e$ : Output voltage due to strain $e_0$ : Output voltage before strain generation $R_0$ : Resistance change due to generation $\Delta R$ : Resistance change due to strain $\epsilon$ : strain $K$ : Gauge Factor of strain gauge  $e = e_0 + \Delta e$ $R_1 = R_0 + \Delta R$ $R = R_0$ $\Delta e = \frac{E}{4} K \epsilon$
Quarter bridge with 3-wire Thermal output of leadwire is cancelled. 		<p>Terminal code E D C B A</p>	<p>short-circuited</p>	$e = e_0 + \Delta e$ $R_1 = R_0 + \Delta R$ $R = R_0$ $\Delta e = \frac{E}{4} K \epsilon$
Quarter bridge 3-wire with two gauges connected in series in one arm, eliminating bending strain 		<p>Terminal code E D C B A</p>	<p>strain gauge 60Ω each short-circuited</p>	$R_1 = R_0 + \Delta R$ $R_2 = R_0 + \Delta R$ $R = 2R_0$ $\Delta e = \frac{E}{4} K \epsilon$
Quarter bridge with four gauges connected in series and paralleled in one arm 		<p>Terminal code E D C B A</p>	<p>short-circuited</p>	$R_1 = R_2 = R_3 = R_4 = R_0 + \Delta R$ $R = R_0$ $\Delta e = \frac{E}{4} K \epsilon$
Half bridge with 1-active and 1-dummy gauge 				$R_1 = R_0 + \Delta R$ $R_2 = R_0 = R$ $\Delta e = \frac{E}{4} K \epsilon$
Half bridge with two active gauges 		<p>Terminal code E D C B A</p>	<p>short-circuited</p>	$R_1 = R_0 + \Delta R$ $R_2 = R_0 - \nu \Delta R$ $\Delta e = \frac{E(1+\nu)}{4} \cdot K \epsilon$ $\nu$ : Poisson's ratio
Half bridge with 2 active gauges : Bending strain 				$R_1 = R_0 + \Delta R$ $R_2 = R_0 - \Delta R$ $R = R_0$ $\Delta e = \frac{E}{2} K \epsilon$

Output voltage due to strain is based on the condition that output voltage before strain generation ( $e_0$ ) is zero.

## STRAIN GAUGE BRIDGE CIRCUIT

Connection diagram varies according to strainmeter type.

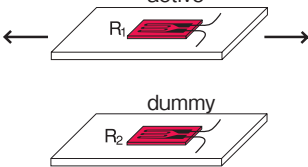
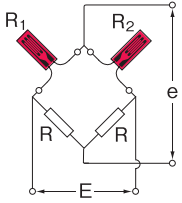
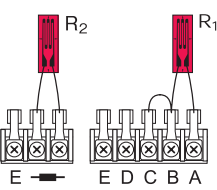
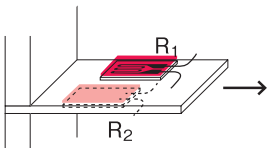
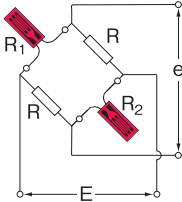
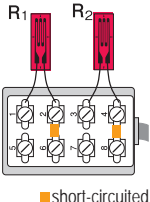
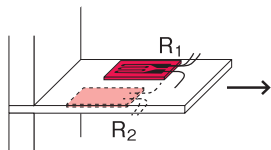
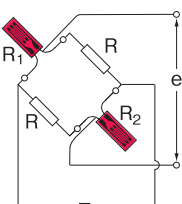
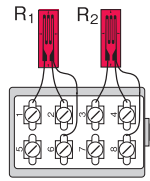
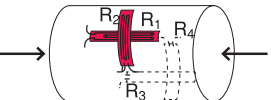
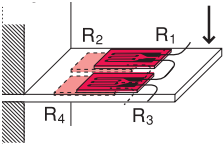
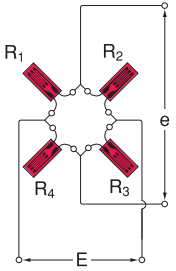
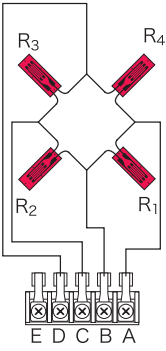
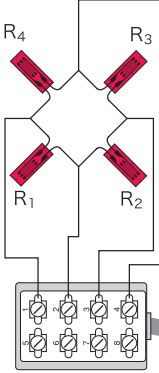
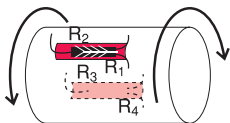
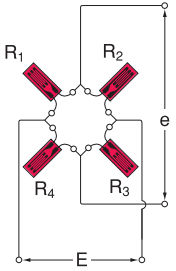
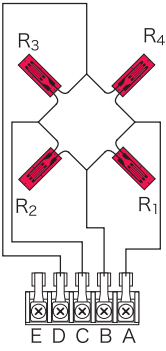
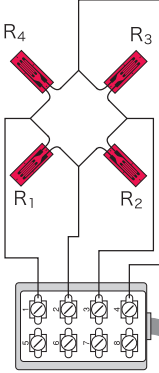
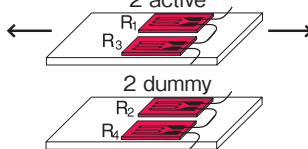
Measuring mode	Bridge circuit	Wiring connection to		Bridge Output
		Switching Box	Bridge Box	
<p>Half bridge common dummy R<sub>2</sub> is used for two or more channels as a common dummy active</p> 			<p>Available only by switching box</p>	$R_1 = R_0 + \Delta R$ $R_2 = R_0 = R$ $\Delta e = \frac{E}{4} K \epsilon$
<p>Opposite arm Half bridge with 2 active gauges</p> 		<p>Available only by bridge box Applicable type SB-120B SB-350B SB-128A SB-123A SB-353A</p>	 <p>■ short-circuited</p>	$R_1 = R_0 + \Delta R$ $R_2 = R_0 + \Delta R$ $R = R_0$ $\Delta e = \frac{E}{2} K \epsilon$
<p>Opposite arm Half bridge with 3-wire 2 active gauges</p> 		<p>Available only by bridge box Applicable type SB-120B SB-350B SB-128A SB-123A SB-353A</p>		$R_1 = R_0 + \Delta R$ $R_2 = R_0 + \Delta R$ $R = R_0$ $\Delta e = \frac{E}{2} K \epsilon$
<p>Full bridge with 4 active gauges : Uniaxial strain</p> 				$R_1 = R_3 = R_0 + \Delta R$ $R_2 = R_4 = R_0 - \nu \cdot \Delta R$ $\Delta e = \frac{E(1+\nu)}{2} \cdot K \epsilon$ $\nu$ : Poisson's ratio
<p>Full bridge with 4 active gauges : Bending strain</p> 				$R_1 = R_3 = R_0 + \Delta R$ $R_2 = R_4 = R_0 - \Delta R$ $\Delta e = EK \epsilon$
<p>Full bridge with 4 active gauges : Torque</p> 				$R_1 = R_3 = R_0 + \Delta R$ $R_2 = R_4 = R_0 - \Delta R$ $\Delta e = EK \epsilon$
<p>Full bridge with 2 active gauges and 2 dummy gauges</p> 				$R_1 = R_3 = R_0 + \Delta R$ $R_2 = R_4 = R$ $R = R_0$ $\Delta e = \frac{E}{2} K \epsilon$

Output voltage due to strain is based on the condition that output voltage before strain generation ( $e_0$ ) is zero.



# STRAIN GAUGE CODING SYSTEM

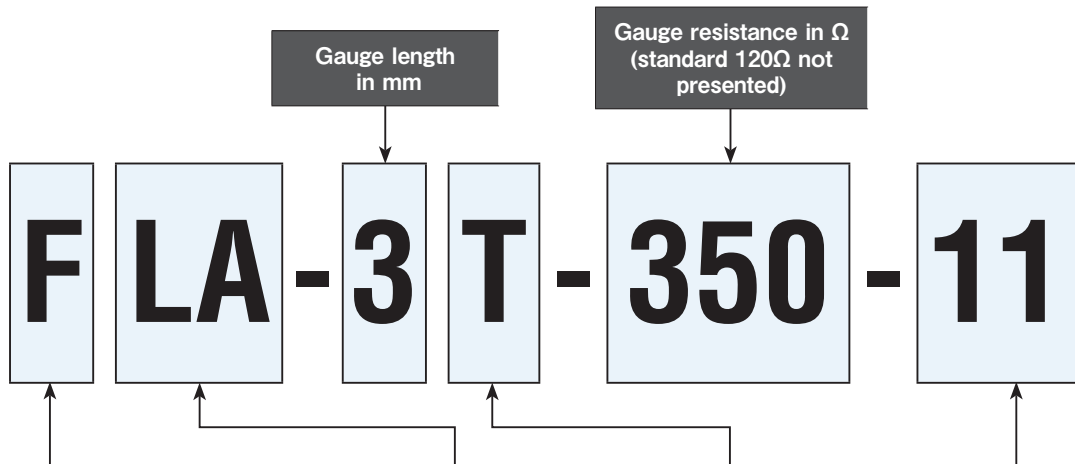

Gauge series	Applications	Pattern configuration (*1)	Functions (*2)	Applicable gauge
F	General purpose Residual stress, Stress concentration, Chain gauge	L/LA/LK/LX/LG/BX/BY LAB/LKB/LGB <b>GOBIET</b>	T Integrated with thermocouple	Applicable to most of strain gauges
WF	Waterproof construction	C/CA/LC/CS/CB	A Left 45°	OFLT
PF	Concrete use, Polyester foil gauge	CAB <b>GOBIET</b>	B Right 45°	OFLT
P	Concrete use, Polyester wire gauge	R/LR/RA/RAS/RS	W Large width	FLAB, QFLAB, Some of 350Ω strain gauges
FLM/WFLM	Concrete use, Metal backing strain gauge	RAB <b>GOBIET</b>	(*2) Not indicated for general strain gauges	
MF/QMF	Magnetic field use	XV/YV/BXV/BYV		
PMF	Concrete use, Embedment type strain gauge	CV		
YEF/YF/YHF	Post-yield strain (Large strain) measurement	CT		
PMFLS	Asphalt use, Embedment type strain gauge	LT		
LF	Low elastic material use, Wood, Gypsum			
PFLW/PLW	Low elastic material use, Wood, Gypsum			
GF	Low elastic material use, Plastics			
BF/UBF	Composite material use			
DSF	High endurance use, Fatigue test			
CF	Cryogenic temperature use			
CEF	Wide range temperature use			
QF/ZF/EF	High temperature use			
SFA	Stress measurement			
AW	Weldable strain gauge			
BTM	Bolt axial strain measurement			
DD	One-side gauge			
FAC	Crack detection gauge			
TF	Strain gauge type temperature measurement			
KM	Concrete/Asphalt embedment use, strain transducer			
FGMH	Frictional Strain Checker			
FGAH	Frictional Axial strain transducer			
FGDH	Frictional Torque Sensor System			

(\*1) Not always coded  
0°/90° 2-axis  
0°/45°/90° 3-axis

Compensation material ppm/° C (*3)			
3	Composite material		17 Stainless steel/Copper alloy
	Ceramic (Si <sub>3</sub> N <sub>4</sub> )	2.6~3.3	SUS 304 16.2
	CFRP	3 - 5	SUS 310 15.8
5	Composite material		SUS 316 16
	Ceramic (SiC)	4.6	SUS 321 16.7
	CFRP	3 - 5	Copper 16.7
8	Composite material		Beryllium copper 16.6
	Glass	7.9	Brass 16.7
	Titanium	8.9	Bronze 17
	Titanium alloy (Ti-6Al-4V)	8.8	Constantan 14.9
11	Mild steel		23 Aluminium
	Mild steel (0.1~0.2C)	11.8	Aluminium 23.4
	Hard steel (0.4~0.5C)	11.2	Aluminium 2024-T4 23
	Cast iron	10.5	Lead and its alloy 29
	Hastelloy-276	11.2	Gypsum 25
	Inconel 600	13.3	Polyimide 20-30
	Inconel 750	12.1	
28	Monel	13.5	Magnesium
	SUS 630 (17-4PH)	10.8	Magnesium alloy 27
	SUS 631 (17-7PH)	10.6	
	Concrete	7-13	50 Plastics
70			Epoxy (Cast) 45-65
			Plastics
			Acrylics 70
			ABS 74
			Polyacetal (POM) 80
		Polycarbonate (PC) 66-70	
		Polystyrene (PS) 60-80	

(\*3) Indicated only for self-temperature-compensated strain gauges.  
For other materials, contact TML or your local representative.

The following strain gauges are CE marked.

- For strain gauge without integral lead wire
- Strain gauge with "-F" appended to the type number
- Strain gauge indicated with "CE" mark in this catalog

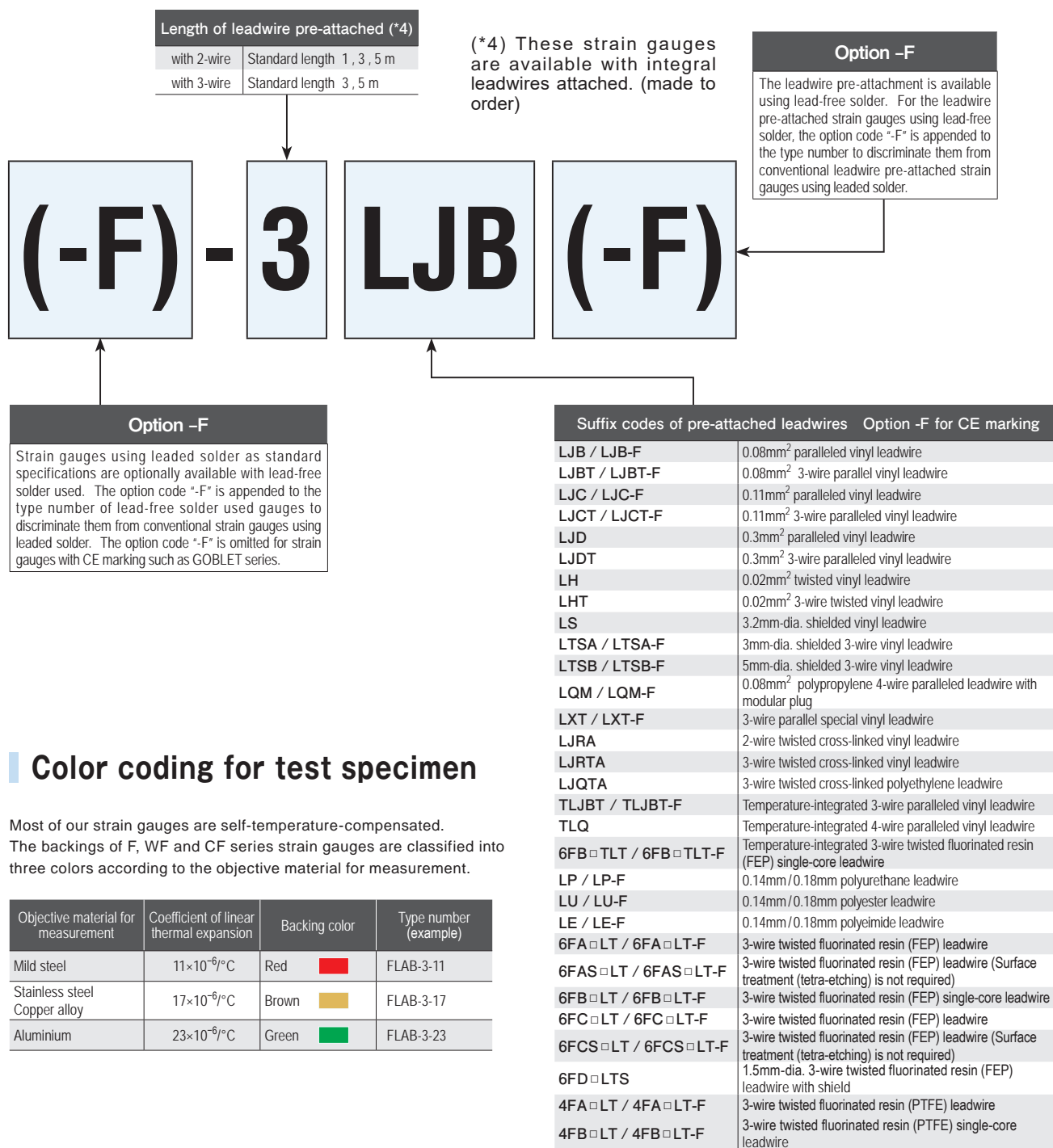

## Color coding for test specimen

Most of our strain gauges are self-temperature-compensated. The backings of F, WF and CF series strain gauges are classified into three colors according to the objective material for measurement.

Objective material for measurement	Coefficient of linear thermal expansion	Backing color	Type number (example)
Mild steel	$11 \times 10^{-6} / ^\circ\text{C}$	Red <span style="color: red;">■</span>	FLAB-3-11
Stainless steel Copper alloy	$17 \times 10^{-6} / ^\circ\text{C}$	Brown <span style="color: brown;">■</span>	FLAB-3-17
Aluminium	$23 \times 10^{-6} / ^\circ\text{C}$	Green <span style="color: green;">■</span>	FLAB-3-23

## Name of each part of strain gauge

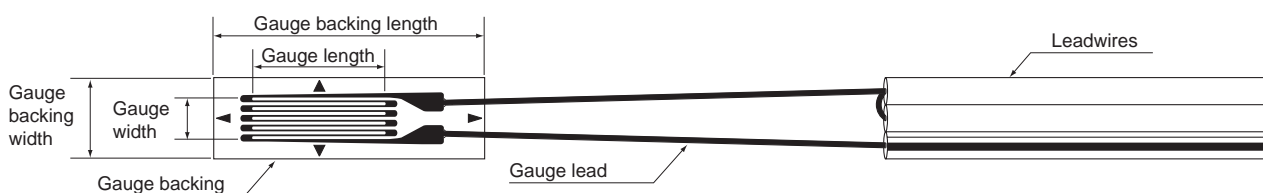

For further information on combination use with strain gauges, refer to pages 39~40.



# STRAIN GAUGE SELECTION

## Strain Gauge Characteristics

Strain gauge series (usage)	Shape	Objective material for measurement	Applicable coefficient of linear thermal expansion ( $\times 10^{-6}/^{\circ}\text{C}$ )	Operating temperature range ( $^{\circ}\text{C}$ )	Temperature compensation range ( $^{\circ}\text{C}$ )	Main applicable adhesive	Material		RoHS2 Directive compliance
							Backing	Grid	
<b>Strain gauge for general use</b>									
F <b>GOBLET</b>	Single/Multi-axis	Metal Glass Ceramic	8,11,17,23	-196~+150 $^{\circ}\text{C}$	+10~+100 $^{\circ}\text{C}$	CN,P-2 EB-2	Special plastics	Cu-Ni	CE marked
F	Stress concentration Shearing/Torque	Metal Glass Ceramic	8,11,17,23	-196~+150 $^{\circ}\text{C}$	+10~+100 $^{\circ}\text{C}$	CN,P-2 EB-2	Special plastics	Cu-Ni	Partly compliant with Option -F (except general strain gauges)
<b>Strain gauge with waterproof construction</b>									
WF	Single/Multi-axis	Metal Glass Ceramic	11,17,23	0~+80 $^{\circ}\text{C}$	+10~+80 $^{\circ}\text{C}$	CN,P-2	Epoxy	Cu-Ni	CE marked
<b>Strain gauge for high temperature use</b>									
QF <b>GOBLET</b>	Single/Multi-axis	Metal Ceramic	11,17,23,28	-30~+200 $^{\circ}\text{C}$	+10~+100 $^{\circ}\text{C}$	CN,C-1 NP-50B	Polyimide	Cu-Ni	CE marked
QF	Stress concentration Shearing/Torque	Metal Ceramic	11,17,23,28	-20~+200 $^{\circ}\text{C}$	+10~+100 $^{\circ}\text{C}$	CN,C-1 NP-50B	Polyimide	Cu-Ni	Partly compliant with Option -F (except general strain gauges)
ZF	Single/Multi-axis	Metal Ceramic	11,17,23	-20~+300 $^{\circ}\text{C}$	+10~+100 $^{\circ}\text{C}$	CN,C-1 NP-50B	Polyimide	Ni-Cr	Not applicable (high melting point solder) CE marked
EF	Single	Metal	11	-196~+300 $^{\circ}\text{C}$	+10~+150 $^{\circ}\text{C}$	CN,C-1 EB-2 NP-50B	Polyimide	Ni-Cr	Not applicable (high melting point solder) CE marked
	Multi-axis			-196~+200 $^{\circ}\text{C}$	0~+150 $^{\circ}\text{C}$				Not compliant
<b>Strain gauge for high and low temperature use</b>									
CEF	Single	Metal Ceramic	11,17,23	-269~+200 $^{\circ}\text{C}$	-196~+80 $^{\circ}\text{C}$ *1	CN,C-1 EA-2A	Polyimide	Special alloy	Not applicable (high melting point solder) CE marked
<b>Strain gauge for cryogenic temperature use</b>									
CF	Single/Multi-axis	Metal Ceramic	11,17,23	-269~+80 $^{\circ}\text{C}$	-196~+80 $^{\circ}\text{C}$ *1	CN,C-1 EA-2A	Special plastics	Special alloy	Not applicable (high melting point solder) CE marked
<b>Weldable strain gauge</b>									
AWM	Single	Metal	11,17	-196~+300 $^{\circ}\text{C}$	RT~+300 $^{\circ}\text{C}$	Spot welding	SUS304 Inconel 600	Special alloy	CE marked
AWMD	Single	Metal	12	-196~+800 $^{\circ}\text{C}$	****	Spot welding	Inconel 600	Special alloy	CE marked
AWH	Single	Metal	11,17	-196~+650 $^{\circ}\text{C}$ *2	RT~+600 $^{\circ}\text{C}$	Spot welding	SUS304 Inconel 600	Special alloy	CE marked
AWHU	Single	Metal	11	-196~+800 $^{\circ}\text{C}$	RT~+800 $^{\circ}\text{C}$	Spot welding	Inconel 600	Special alloy	CE marked
AW-6	Single	Metal	11	-196~+300 $^{\circ}\text{C}$	+10~+100 $^{\circ}\text{C}$	Spot welding	SUS304	Special alloy	CE marked
AWC-8B	Single	Metal	11	-20~+100 $^{\circ}\text{C}$	+10~+100 $^{\circ}\text{C}$	Spot welding	SUS304	Special alloy	Not compliant
<b>Strain gauge for concrete and mortar</b>									
P	Single/Multi-axis	Concrete Mortar	11	-20~+80 $^{\circ}\text{C}$	+10~+80 $^{\circ}\text{C}$	CN-E RP-2,PS	Polyester	Cu-Ni wire	CE marked
PF	Single/Multi-axis	Metal Mortar	11	-20~+80 $^{\circ}\text{C}$	+10~+80 $^{\circ}\text{C}$	CN-E RP-2,PS	Polyester	Cu-Ni	CE marked
FLM/WFLM	Single	Concrete Mortar	11	-20~+80 $^{\circ}\text{C}$	+10~+80 $^{\circ}\text{C}$	PS	SUS304	Ni-Cr	Not compliant
<b>Mold strain gauge</b>									
PMF	Single	Concrete Mortar	****	-20~+60 $^{\circ}\text{C}$	****	Embedment	Special plastics	Cu-Ni	Compliant with Option -F
PMFLS	Single	Asphalt	****	-20~+60 $^{\circ}\text{C}$	****	Embedment	Special plastics	Cu-Ni	Compliant with Option -F

\*1: Approximately temperature compensated range

\*2: Up to +600 $^{\circ}\text{C}$  for static measurement, Up to +650 $^{\circ}\text{C}$  for dynamic measurement

	Strain limit in room temperature ( $\mu\epsilon$ )	Fatigue life Strain level Number of cycles	Description	See page
F	5% (50,000)	$\pm 1,500\mu\epsilon$ $1 \times 10^6$	These are CE marked strain gauges (compliant to RoHS2 Directive) for general use having a new series name "GOBLET". They have joined to our well proven F-series general-use strain gauges. CE marked leadwires are also available in combination with the strain gauges.	42
F	5% (50,000)	$\pm 1,500\mu\epsilon$ $1 \times 10^6$	These are foil strain gauges for general use having expanded operating temperature range of -196 to +150°C by the employment of special plastics backings. The backing is color coded to identify the objective material for self temperature compensation. Strain gauges using lead-free solder are available with option code -F. Various leadwires are also available for this series to meet diverse measurement conditions.	45
WF	3% (30,000)	$\pm 1,500\mu\epsilon$ $3 \times 10^4$	These are F-series strain gauges with integral vinyl leadwires. Whole area of the strain gauge and the leadwire junction are coated with epoxy resin for water proofing. The coating is transparent and flexible, so the positioning and bonding works are very easy. By merely bonding the gauge with an adhesive, outdoor or underwater measurement for a short-term becomes possible.	47
QF	3% (30,000)	$\pm 1,500\mu\epsilon$ $1 \times 10^6$	These are CE marked strain gauges (compliant to RoHS2 Directive) with backings made of polyimide resin. They are suited to strain measurement in high temperature up to 200°C. They are also used for strain gauge type transducers such as load cells.	48
QF	3% (30,000)	$\pm 1,500\mu\epsilon$ $1 \times 10^6$	These are strain gauges utilizing polyimide resin as the backing material. They are suited to strain measurement in high temperature up to 200°C. They are also used as the strain sensing element in strain gauge type transducers such as load cells.	49
ZF	1% (10,000)	$\pm 1,500\mu\epsilon$ $1 \times 10^6$	These strain gauges utilize specially designed Ni-Cr alloy foil for the grid and polyimide resin for the gauge backing. Owing to the construction, these strain gauges are successfully used for measurement in high temperature up to 300°C.	50
EF	1% (10,000)	$\pm 1,500\mu\epsilon$ $1 \times 10^6$	These are extremely small strain gauges enabling strain measurement in narrow space. Single element gauge is applicable to measurement in high temperature up to 300°C. Two or three element gauge is applicable to measurement up to 200°C. In cryogenic temperature range, all gauges are applicable down to -196°C.	51
QEF	1% (10,000)	$\pm 1,500\mu\epsilon$ $1 \times 10^6$	These strain gauges feature a wide range of operating temperature from cryogenic temperature to +200°C. They utilize polyimide resin for the gauge backing. This series is available only in single axis configuration with gauge length of 1,3 and 6mm.	52
QF	1% (10,000)	$\pm 1,500\mu\epsilon$ $1 \times 10^6$	These are strain gauges designed for measurement in cryogenic temperature. They are available in single element, 2-element and 3-element configurations with 350Ω resistance. The thermal output is stable even under cryogenic conditions.	53
AWM	1% (10,000)	$\pm 1,000\mu\epsilon$ $1 \times 10^6$	This strain gauge has a strain sensing element fully encapsulated in a metal tube. The connection method is quarter bridge 3-wire. It is suited to measurement in high temperature up to 300°C and/or in harsh environment. This strain gauge is installed using our spot welder W-50RC.	55
AWMD	1% (10,000)	$\pm 1,000\mu\epsilon$ $1 \times 10^6$	This strain gauge has a sensing element of quarter bridge 3-wire connection which is fully encapsulated in a metal tube. It is measured in full bridge method using the attached high pass filter. It is suited to measurement in high temperature up to 800°C and/or in harsh environment. This strain gauge is applicable only for dynamic strain measurement using DC exciting dynamic strain meter. It is installed using our spot welder W-50RC.	55
AWH	0.6% (6,000)	$\pm 1,000\mu\epsilon$ $1 \times 10^6$	The sensing element is made of special alloy and is fully encapsulated in a corrosion-resistant metal tube such as Inconel 600. The sensing part has half bridge configuration with active element and dummy element, and it is measured in full bridge method using the attached temperature compensation circuit board. This gauge is suited to static measurement in high temperature up to 600°C (650°C for dynamic measurement). It is applicable to use in various environment including gas or liquid. Installation is made using our spot welder W-50RC.	56
AWHU	1% (10,000)	$\pm 1,000\mu\epsilon$ $1 \times 10^6$	The sensing element is made of special alloy and is fully encapsulated in a corrosion-resistant metal tube such as Inconel 600. The sensing part has half bridge configuration with active element and dummy element, and it is measured in full bridge method using the attached temperature compensation circuit board. This gauge is available for use in high temperature up to 800°C for both of static and dynamic measurement. It is applicable to use in various environment including gas or liquid. Installation is made using our spot welder W-50RC.	56
AWG	0.5% (5,000)	$\pm 1,000\mu\epsilon$ $1 \times 10^6$	The construction of this strain gauge is that a high temperature strain gauge is bonded on a thin stainless steel sheet (0.08mm thick) with heat-curing adhesive. Strain measurement in temperature up to 300°C is possible by this strain gauge. It is suited to measurement of a specimen on which strain gauge bonding is not possible, and/or to a long term measurement. Installation is made using our spot welder W-50RC.	57
AWC	0.5% (5,000)	$\pm 1,000\mu\epsilon$ $1 \times 10^6$	The sensing element of this strain gauge is encapsulated in a stainless steel tube with adhesive. Owing to the sealed construction, this strain gauge is suited to measurement under water and/or for a long term. It is installed by spot welding the stainless steel backing using our spot welder W-50RC.	57
P	2% (20,000)	$\pm 1,000\mu\epsilon$ $1 \times 10^5$	These strain gauges utilize a thin wire as the sensing element and have comparatively long gauge lengths. They are mainly used for measurement on concrete. Since the backing is transparent, the bonding position can easily be checked in the installation works. Strain gauges with integral leadwires are available with CE marking.	59
PF	2% (20,000)	$\pm 1,500\mu\epsilon$ $1 \times 10^6$	These strain gauges have polyester resin backings which are the same as P series, while they have sensing elements made of foil. They can be handled as easily as P series gauges. They are applicable to various materials including concrete, mortar and metals. Strain gauges with integral leadwires are available with CE marking.	60
FLM/WFLM	0.5% (5,000)	$\pm 1,000\mu\epsilon$ $1 \times 10^5$	These strain gauges have resin backings lined with metal foil for the purpose of preventing the penetration of moisture from the reverse side. They are exclusively used for the measurement of strain on concrete surface. The WFLM gauges have moisture proofing over-coating and integral leadwire in addition to the metal backing. It is suited to long term measurement or measurement on underwater-curing concrete.	61
PMF	****	****	These gauges are designed for measurement of internal strain of concrete or mortar. They are embedded into the measurement position when the concrete or mortar is placed. These gauges are exclusively used for short term measurement such as a loading test. For long term measurement, the use of strain transducer [KM] is recommended. (see page 63-64)	62
PMF-LS	****	****	This strain gauge utilizes super engineering plastics for the backing material, which exhibit excellent water and heat resistance. It withstands the high temperature of 200°C when the asphalt is placed. This strain gauge is manufactured using lead-free solder with option code -F.	62



# STRAIN GAUGE SELECTION

## Strain Gauge Characteristics

Strain gauge series (usage)	Shape	Objective material for measurement	Applicable coefficient of linear thermal expansion ( $\times 10^{-6}/^{\circ}\text{C}$ )	Operating temperature range ( $^{\circ}\text{C}$ )	Temperature compensation range ( $^{\circ}\text{C}$ )	Main applicable adhesive	Material		RoHS2 Directive compliance
							Backing	Grid	
Strain gauge for composite material									
UBF	Single	Composite material	****	Static -30~+120 $^{\circ}\text{C}$ Dynamic -30~+150 $^{\circ}\text{C}$	****	CN,EB-2 NP-50B	Polyimide amide	Cu-Ni	CE marked
BF <b>GOBLET</b>	Single/Multi-axis	Composite material	3, 5, 8	-30~+200 $^{\circ}\text{C}$	+10~+80 $^{\circ}\text{C}$	CN,EB-2 NP-50B	Polyimide	Cu-Ni	CE marked
Strain gauge for low elastic modulus material									
GF <b>GOBLET</b>	Single/Multi-axis	Plastics	50, 70	-30~+80 $^{\circ}\text{C}$	+10~+80 $^{\circ}\text{C}$	CN	Special plastics	Cu-Ni	CE marked
LF <b>GOBLET</b>	Single	Wood Gypsum	11	-30~+80 $^{\circ}\text{C}$	+10~+80 $^{\circ}\text{C}$	CN-E	Special plastics	Cu-Ni	CE marked
Strain gauge for long-term measurement on wood									
PFLW	Single	Wood	11	-20~+80 $^{\circ}\text{C}$	+10~+80 $^{\circ}\text{C}$	PS	Polyester	Cu-Ni foil	CE marked
PLW								Cu-Ni wire	
Strain gauge for magnetic field use									
MF	Single	Concrete	****	-20~+80 $^{\circ}\text{C}$	****	CN,CN-E RP-2	Special plastics	Ni-Cr	Not compliant
MF	Multi-axis	Metal	11, 17, 23	-20~+200 $^{\circ}\text{C}$	****	CN NP-50B	Polyimide	Ni-Cr	Not compliant
QMF	Single	Metal	11, 17, 23	-30~+200 $^{\circ}\text{C}$	0~+150 $^{\circ}\text{C}$	CN NP-50B	Polyimide	Ni-Cr	CE marked
Strain gauge for post-yield (large strain) measurement									
YEF	Single/Multi-axis	Metal	****	-30~+80 $^{\circ}\text{C}$	****	CN CN-Y	Special plastics	Cu-Ni	CE marked
YF	Single	Metal	****	-20~+80 $^{\circ}\text{C}$	****	CN CN-Y	Special plastics	Cu-Ni	CE marked
YHF	Single	Metal	****	-30~+80 $^{\circ}\text{C}$	****	CN CN-Y	Special plastics	Special alloy	CE marked
High endurance strain gauge									
DSF	Single	Metal Composite material	****	-60~+200 $^{\circ}\text{C}$	****	CN,EB-2 C-1	Polyimide	Special alloy	Not compliant
One-side strain gauges									
DD	Single axis (2-element)	Metal	****	-10~+70 $^{\circ}\text{C}$	****	CN P-2	Acrylic	Cu-Ni	Compliant with Option -F
Crack detection gauges									
FAC	****	Metal Concrete	****	-30~+80 $^{\circ}\text{C}$	****	CN RP-2	Special plastics	Cu-Ni	CE marked
Stress gauges									
SF	****	Metal	11, 17, 23	-20~+200 $^{\circ}\text{C}$	+10~+100 $^{\circ}\text{C}$	CN,NP-50B C-1	Polyimide	Cu-Ni	CE marked
Temperature gauge									
TF	Single	General materials	****	-20~+200 $^{\circ}\text{C}$	****	CN,NP-50B C-1	Polyimide	Ni	CE marked
Bolt strain gauges									
BTM	Single	Bolt M10 or larger	****	-10~+80 $^{\circ}\text{C}$	****	A-2	Special plastics	Cu-Ni	Not applicable (high melting point solder) CE marked
BTMC	Single	Bolt	****	-10~+80 $^{\circ}\text{C}$	****	CN	Special plastics	Cu-Ni	Not applicable (high melting point solder) CE marked
Frictional strain gauges									
CBF	Single/Multi-axis Torque	Metal Steel	11	0~+60 $^{\circ}\text{C}$	0~+60 $^{\circ}\text{C}$	Not required	Special resin	Cu-Ni	Partly compliant



		Strain limit in room temperature ( $\mu\epsilon$ )	Fatigue life Strain level Number of cycles	Description	See page
	UBF	3% (30,000)	$\pm 1,500\mu\epsilon$ $1 \times 10^6$	These are strain gauges developed for measurement on composite materials. Owing to the development of gauge backing with better compliance, the number of repetition in thermal cycling test and the creep characteristics have been significantly improved compared to conventional strain gauges.	65
	BF	3% (30,000)	$\pm 1,500\mu\epsilon$ $1 \times 10^6$	These are strain gauges designed for measurement on composite materials. They have a specially designed grid pattern to reduce the stiffening effect to the measurement object.	66
	GF	3% (30,000)	$\pm 1,500\mu\epsilon$ $1 \times 10^6$	These strain gauges are suited to the measurement on materials such as plastics, which have low elastic modulus compared to metal. The specially designed grid reduces the stiffening effect of strain gauge to the specimen material, and also reduces the effect of Joule heat in the strain gauge.	67
	LF	3% (30,000)	$\pm 1,500\mu\epsilon$ $1 \times 10^6$	This strain gauge is designed for measurement on materials having low elastic modulus such as wood or gypsum. Its specially designed grid reduces the stiffening effect of the strain gauge to the specimen material.	68
	P-ELW	2% (20,000)	$\pm 1,000\mu\epsilon$ $1 \times 10^5$	These are polyester strain gauges whose backings lined with metal foil. The metal foil prevents the penetration of moisture to the strain gauge and makes it suited to the use for long term measurement.	69
	MF	1% (10,000)	$\pm 1,500\mu\epsilon$ $1 \times 10^6$	These gauges are designed for strain measurement in magnetic field. The sensing element of the gauge is made of a material which exhibits low magnetoresistance effect. In addition, the sensing element is constructed to make the strain gauge less sensitive to the influence of electromagnetic induction.	70
	MF	1% (10,000)	$\pm 1,500\mu\epsilon$ $1 \times 10^6$	These are multi-axis strain gauges designed for strain measurement in magnetic field. They are applicable to the measurement in high temperature up to 200°C. The sensing element of the gauge is made of a material which exhibits low magnetoresistance effect. In addition, the sensing element is constructed to make the strain gauge less sensitive to the influence of electromagnetic induction.	70
	QMF	1% (10,000)	$\pm 1,500\mu\epsilon$ $1 \times 10^5$	These gauges are designed for strain measurement in magnetic field. They are applicable to the measurement in high temperature up to 200°C. The sensing element of the gauge is made of a material which exhibits low magnetoresistance effect. In addition, the sensing element is constructed to make the strain gauge less sensitive to the influence of electromagnetic induction.	71
	YEF	10-15% (100,000-150,000)	$\pm 1,500\mu\epsilon$ $5 \times 10^5$	These strain gauges are applicable to the measurement of large strain up to 10-15%. Also they withstand the repeated strain in elastic range (strain level of about $\pm 1500 \times 10^{-6}$ ) like ordinary strain gauges.	73
	YF	15-20% (150,000-200,000)	****	These strain gauges are applicable to the measurement of large strain up to 15-20%. They are not applicable to the measurement of repeated strain in elastic range as well as in large strain range.	74
	YHF	30-40% (300,000-400,000)	$\pm 1,500\mu\epsilon$ $2 \times 10^4$	These strain gauges are developed for the measurement of very large strain up to 30-40%. They are not applicable to the measurement of repeated strain in elastic range as well as in large strain range.	74
	DSF	1% (10,000)	$\pm 3,000\mu\epsilon$ $1 \times 10^7$	These strain gauges are developed for measurement in fatigue test. They satisfy the fatigue life over 10 million times at a strain level of $\pm 3000 \times 10^{-6}$ strain. It can save the labour and cost for replacing strain gauges during the fatigue test.	76
	DD	0.15% (1,500)	$\pm 1,000\mu\epsilon$ $1 \times 10^5$	These strain gauges are intended for measuring the bending and tensile strains separately by simply bonding the gauge on one side of a plate or beam. They are effectively used for the measurement of a box construction in structures such as bridges or pressure vessels, where the reverse side of the measurement object is not accessible for strain gauge installation. Strain gauges using lead-free solder are newly introduced with option code -F.	76
	FAC	****	****	These gauges are designed to measure the propagation speed of fatigue crack in a metal specimen. The gauge is bonded with an adhesive on the position where the crack is initiated or the crack initiation is expected. The gauge is used together with the crack gauge adapter CGA-120B for the measurement.	77
	SF	****	$\pm 1,500\mu\epsilon$ $1 \times 10^6$	These gauges are intended to measure the stress in an optional direction of the specimen in plane stress field. The gauge is sensitive not only in its axial direction but also in its transverse direction, and the sensitivity ratio of the transverse direction to the axial direction is equal to the Poisson's ratio of the specimen material. In addition, the gauge is not sensitive to the shearing strain. Therefore, the output of the gauge is proportional to the stress in the direction of the gauge axis.	77
	TF	****	****	These gauges are bonded on the specimen surface like ordinary strain gauges, and measure the surface temperature. By combining with the dedicated temperature gauge adapter (TGA-1A or TGA-1B), actual temperature can be measured easily using a strain meter. Gauges using lead-free solder are newly introduced with option code -F.	78
	BTM	****	****	These gauges are used for measurement of tensile strain of bolt. The gauge is simply inserted into a pre-drilled hole in the bolt shank together with A-2 bonding adhesive and cured. Installation service of bolt strain gauge from drilling till bonding and calibration service after the installation are also available.	79
	BTMC	****	****	These gauges are used for measurement of tensile strain of bolt. The BTMC gauges have a tube shape sensing element, and they are installed with fast-curing CN adhesive. The installation is easily made at room temperature.	80
	CBF	****	****	The frictional strain gauge measures strain using frictional force working on the contact surface between the strain gauge and the measurement object by pressing the gauge to the object with a constant force. It is utilized in the Strain Checker FGMH series which is mounted on a steel structure using magnet, and in the Torque Sensor System FGDH series and Axial Strain Transducer FGAH series which enable measurement of torque or axial force by merely being mounted on a drive shaft or tie rod.	83



# Measuring purpose

## Gauge series selection chart

Material - Purpose	Gauges series & Operating temperature (° C)	Bonding adhesive	Coating materials	Lead wire insulator recommended
<b>Metal</b>				
General use Mid-high temperature	-196 / F / <b>GOBIET</b> +150	CN/P-2/EB-2	W-1/N-1/SB tape	Vinyl, FEP(6F)
	-20 PF +80	CN/P-2/EB-2	W-1/N-1/SB tape	Vinyl, Enamel
Underwater	0 WF +80	CN/P-2/EB-2	W-1/N-1/SB tape	-LDDB, -LDBTB
General use High temperature	-30 QF / <b>GOBIET</b> +200	CN/C-1/NP-50B	KE-348	FEP(6F), PTFE(4F)
	-20 ZF +300	CN/C-1/NP-50B	TSE-3976-B	PTFE(4F)
Miniature, High	-196 / EF(Single) +300	CN/EB-2/C-1/NP-50B	KE-348/TSE-3976-B	FEP(6F), PTFE(4F)
Miniature, High	-196 / EF(2-/3-axis) +200			
Wide range temp. Cryogenic temp.	-269 / CEF +200	EA-2A/CN/C-1	K-1	FEP(6F), PTFE(4F)
	-269 / CF +80			
Spot welding	-196 / AWM(Quarter with 3-wire) +300	Spot welding (Welder W-50RC)	Consult TML	MI cable
	-196 / AWM(D Full bridge) for dynamic +800			
	-196 / AWH(Full bridge) for static +600 for dynamic +650			
	-196 / AWHU(Full bridge) +800			
	-196 / AW-6(Quarter with 3-wire) +300			
	-20 AWC +100			
Long-term	-20 ZF +300	C-1/NP-50B	W-1/SB tape	Vinyl/Cross-linked vinyl / PTFE(4F)
	-196 / AW-6(Quarter with 3-wire) +300	Spot welding		
Stress concentration	-196 / F +150	CN/P-2/EB-2	W-1/SB tape	Vinyl
	-20 QF +200	CN/C-1/NP-50B	KE-348	FEP(6F)
Residual stress	-196 / F +150	CN	KE-348/N-1	Vinyl
Torque	-196 / F +150	CN/P-2/EB-2	W-1/SB tape	Vinyl
	-20 QF +200	CN/C-1/NP-50B	KE-348	FEP(6F)
Shear strain	-20 QF +200	CN/C-1/NP-50B	KE-348	Vinyl, FEP(6F)
Bending/Tensile strain	-10 DD +70	CN/P-2	---	Vinyl
Bolt axial strain	-10 BTM +80	A-2	---	Vinyl
Large strain	-20 YF +80	CN/CN-Y	SB tape	Vinyl
	-30 YEF/YHF +80			
<b>Metal or Concrete</b>				
Magnetic field use	-20 MF(Single) +80	CN/CN-E/RP-2	W-1/SB tape	Twisted vinyl with shield
	-20 MF(2-/3-axis) +200	CN/NP-50B/EB-2/C-1	KE-348	Twisted FEP with shield
<b>Concrete or Mortar</b>				
Surface strain	-20 P/PF +80	CN-E/RP-2/PS	W-1/SB tape	Vinyl, Cross-linked polyethylene
	-20 FLM/WFLM	PS		
Internal strain	-20 PMF +60	Embedment	---	Cross-linked vinyl
<b>Asphalt</b>				
Internal strain	-20 PMFLS +60	Embedment	---	Chloroprene
<b>Plastics</b>				
General purpose	-30 GF +80 <b>GOBIET</b>	CN	W-1/N-1/SB tape	Vinyl
<b>Composite</b>				
General purpose	-30 BF <b>GOBIET</b> +200	CN/NP-50B/EB-2	W-1/SB tape	Vinyl, FEP(6F)
	-30 UBF for static +120 for dynamic +150	CN/EB-2		
Fatigue test	-60 DSF +200	CN/C-1/EB-2	---	Vinyl, FEP(6F)
<b>Printed circuit board</b>				
General purpose	-196 / EF(Single) +300	CN/NP-50B/EB-2	---	Vinyl, FEP(6F), PTFE(4F)
	-196 / EF(2-/3-axis) +200			
<b>Wood long-term/Gypsum</b>				
General purpose	-30 LF +80 <b>GOBIET</b>	CN-E	W-1/N-1/SB tape	Vinyl
	-20 PFLW/PLW +80	PS/CN-E		
<b>General use</b>				
Temperature	-20 TF +200	CN/C-1/NP-50B	W-1/SB tape	Vinyl, FEP(6F)



# Operating temperature range

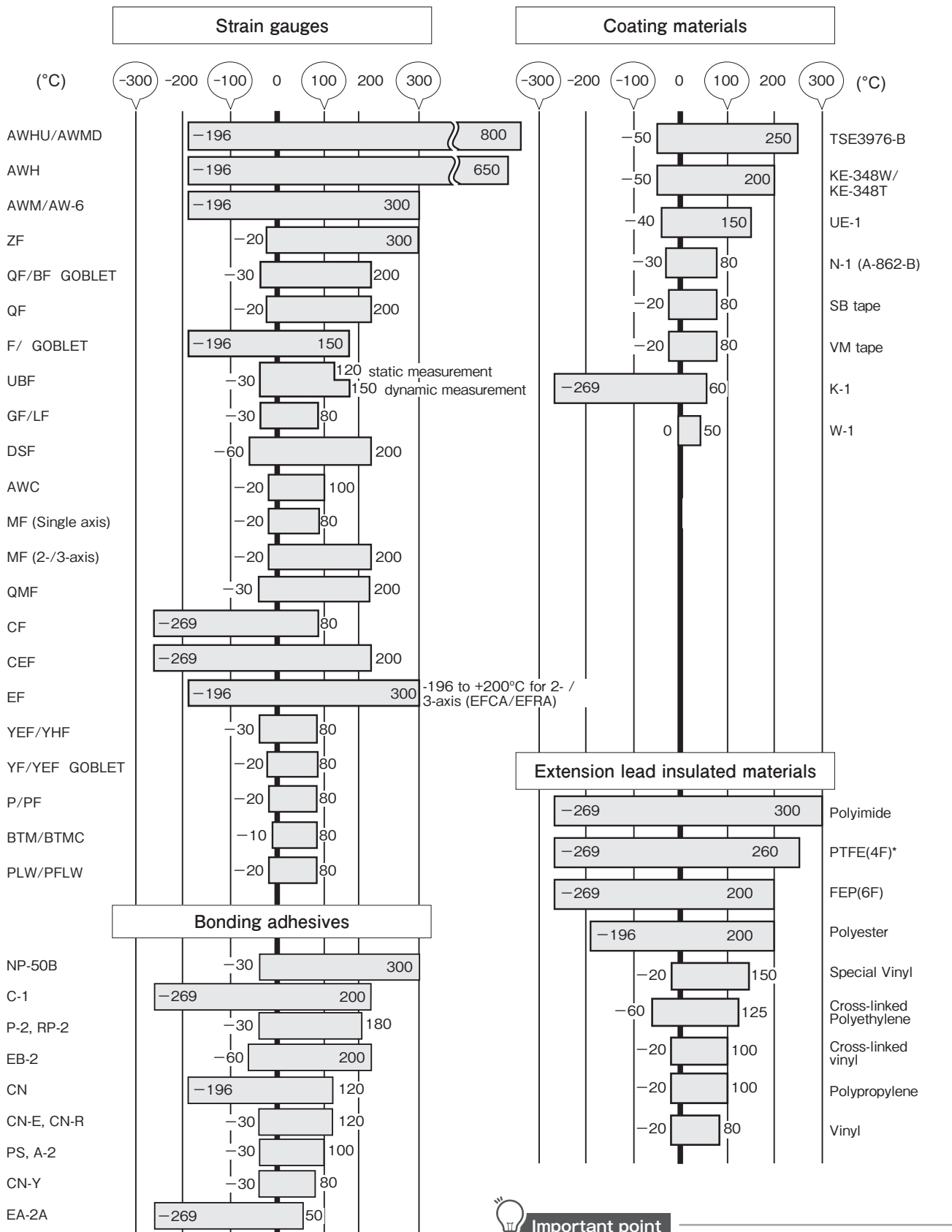

**Important point**  
 N.B.: PTFE(4F)  
 Short term use of 300°C available



# PACKAGE DESIGNATION

TML strain gauges are delivered together with TML Strain Gauge Test Data (example shown below). The evaluation methods conform to the National Aerospace Standard NAS942 (modified). For installation, handling and bonding procedures, please see the data sheet.

## GAUGE PACKAGE

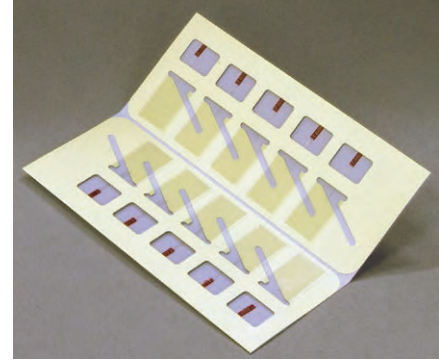
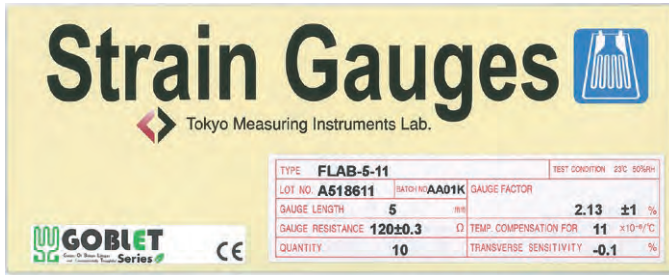

CE compliance

Affixing the CE marking and our logo mark of strain gauge GOBLET series to a container package

Batch No.

Production code for procedure and history.

Environment

Temperature in degrees centigrade and relative humidity in % at which the test data are obtained.

### TEST DATA

Gauge type	TYPE	FLAB-5-11	TEST CONDITION	23°C 50%RH
Lot No.	LOT NO.	A516611	BATCH NO.	RK32C
	GAUGE LENGTH	5 mm	GAUGE FACTOR	2.10 ±1 %
	GAUGE RESISTANCE	120±0.3 Ω	TEMP. COMPENSATION FOR	11 ×10 <sup>-6</sup> /°C
	QUANTITY	10	TRANSVERSE SENSITIVITY	0.3 %

**Quantity**  
Number of gauges contained in a package.

**Gauge resistance**  
Electrical resistance of the strain gauge under free conditions at room temperature, unbonded as supplied. Various range (60, 120, 350 or 1000Ω) are available.

**Gauge length**  
This represents the actual grid length in the axial direction. Within this length, the measured strain is averaged.

**Ratio of transverse sensitivity**  
The sensitivity in the direction perpendicular to the axial direction in percent.

**Applicable temperature compensation**  
Various temperature compensation values are available (3, 5, 8, 11, 17, 23, 28, 50, 70ppm/°C) (Blank indicates temperature compensation not available.)

**Gauge factor with tolerance**  
This factor is a ratio of the resistance variation to the strain generated due to the uniaxial stress in the direction of the gauge axis.

## COLOR CODING FOR TEST SPECIMEN

Colors of package label differ depending on the test specimen material for temperature compensation.

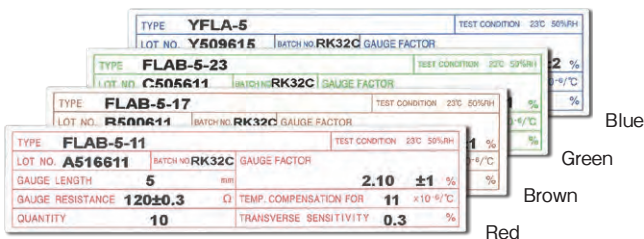

Test specimen	Linear thermal expansion coefficient	Coloring	Gauge type exempld
Mild steel	11 × 10 <sup>-6</sup> /°C	Red	FLAB-5-11
Stainless steel Copper alloy	17 × 10 <sup>-6</sup> /°C	Brown	FLAB-5-17
Aluminium	23 × 10 <sup>-6</sup> /°C	Green	FLAB-5-23
Others	-	Blue	YEFLAB-5

# LEADWIRE-INTEGRATED STRAIN GAUGE PACKAGE

LJCT : 3-wire system

TYPE <b>FLAB-5-11-3LJCT-F</b>	
LOT NO. <b>A518611</b>	GAUGE LENGTH <b>5 mm</b>
GAUGE FACTOR <b>2.13 ±1 %</b>	
GAUGE RESISTANCE <b>120±0.5 Ω</b>	QUANTITY <b>10</b>
TEMP. COMPENSATION FOR <b>11 ×10<sup>-6</sup>/°C</b>	TEST CONDITION <b>23°C 50%RH</b>
TRANSVERSE SENSITIVITY <b>-0.1 %</b>	BATCH NO. <b>AA01K</b>
LEAD WIRES <b>10/0.12 3W 3m</b>	

LJB : 2-wire system

TYPE <b>FLAB-5-11-5LJB-F</b>	
LOT NO. <b>A518611</b>	GAUGE LENGTH <b>5 mm</b>
GAUGE FACTOR <b>2.13 ±1 %</b>	
GAUGE RESISTANCE <b>117.7±0.3 Ω</b>	QUANTITY <b>10</b>
TEMP. COMPENSATION FOR <b>11 ×10<sup>-6</sup>/°C</b>	TEST CONDITION <b>23°C 50%RH</b>
TRANSVERSE SENSITIVITY <b>-0.1 %</b>	BATCH NO. <b>AA01K</b>
LEAD WIRES <b>7/0.12 2W 5m r=0.44Ω/m</b>	



### LEADWIRES

Core number/diameter Wiring system Length of leadwire  
 FLAB-5-11-3LJCT-F (Left)  
 10/0.12 3W 3m : 10-core 0.12mm diameter, 3-wire, 3-meter long.  
 FLAB-5-11-5LJB-F (Right)  
 7/0.12 2W 5m r=0.44Ω/m : 7-core 0.12mm diameter, 2-wire, 5-meter long, leadwire resistance per meter 0.44Ω above

### GAUGE RESISTANCE

For pre-attached strain gauge, the gauge resistance value does not include the lead wire resistance. For correction of gauge factor due to the prolonged leadwire resistance, refer to the resistance per meter (r value) given in LEAD WIRES.

## STRAIN GAUGE TEST DATA

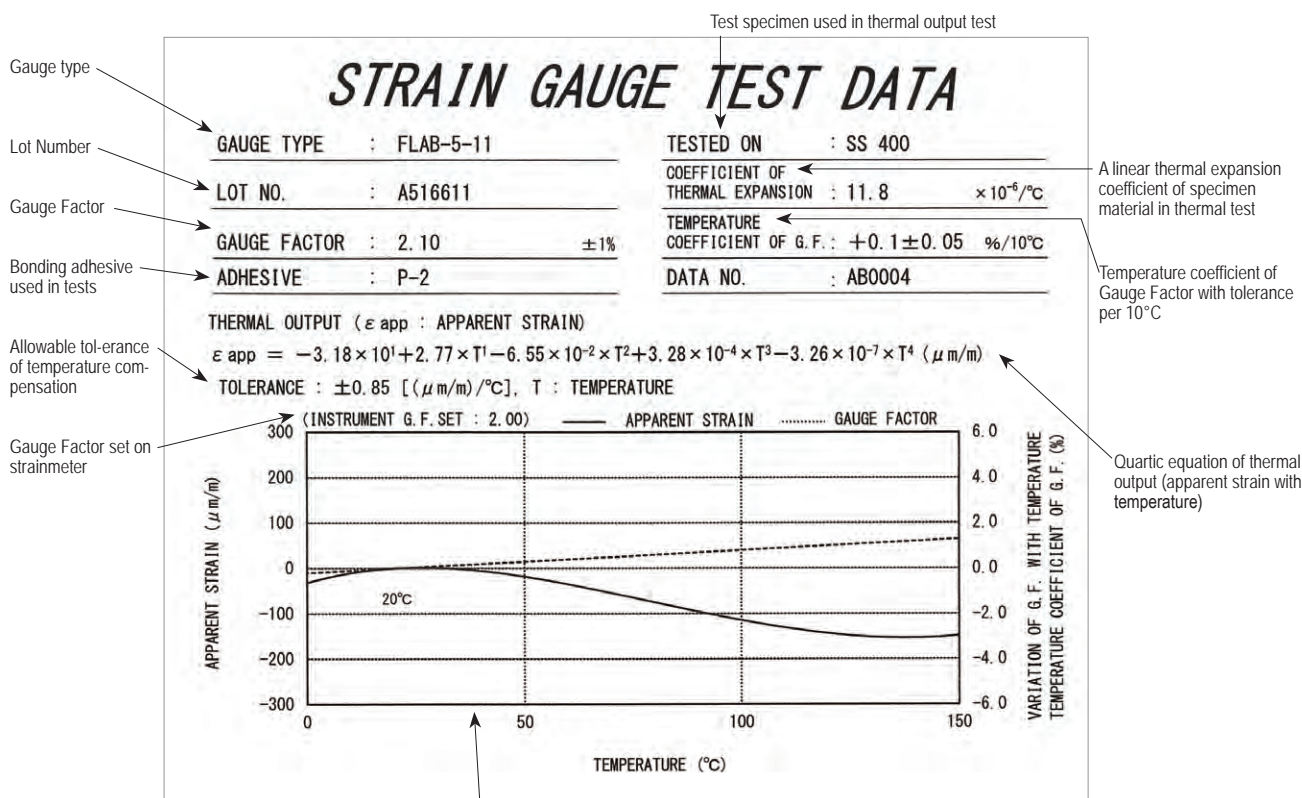

Example of curved data on thermal output

## GAUGE FACTOR OF LEADWIRE PRE-ATTACHED STRAIN GAUGES

The gauge factor of a leadwire pre-attached strain gauge given in its STRAIN GAUGE TEST DATA and package label is a value of the strain gauge itself. Since the given gauge factor does not include the influence of the leadwire resistance, it should be corrected referring to the description of "Gauge factor correction due to leadwire" in "Handling of strain gauge" which is found in the attached test data. The correction should be made considering the influence of all leadwires that are actually connected.



# PRIMARY INSTALLATIONS - Bonding strain gauges

When bonding the strain gauges, the most suitable adhesive should be selected for each application. A typical installation procedure is described below using the fast-curing adhesive CN.

## 1. Preparation

The following items are required for bonding and leadwire connection: Strain gauges, bonding adhesive, connecting terminals, test specimen, solvent, cleaning tissue for industrial use, soldering iron, solder, abrasive paper (120 - 320 grit), marking pencil, scale, tweezers, extension leadwire, polyethylene sheet, nippers.

## 2. Positioning

Roughly determine a location on the test specimen where the strain gauge is to be bonded.

## 3. Surface preparation

Before bonding, remove all grease, rust, paint, etc., from the bonding area to provide a shiny metallic surface. Use abrasive paper to abrade an area somewhat larger than the bonding area uniformly and finely with abrasive paper. Finish the surface with #120 to 180 abrasive paper for steel, or #240 to 320 for aluminium.

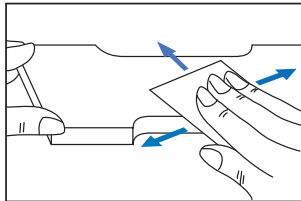

## 4. Fine cleaning

Clean the abraded surface with industrial tissue or cloth soaked in a small quantity of chemical solvent such as acetone. Continue cleaning until a new tissue or cloth comes away completely free of contamination. Following the surface preparation, be sure to attach the gauge before the surface becomes covered with an oxidizing membrane or becomes newly contaminated.

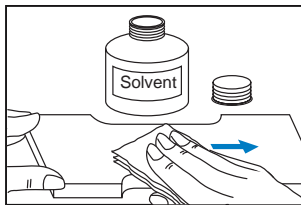

## 5. Applying bonding adhesive

Drop a proper amount of adhesive onto the back of the gauge base. Usually one drop of adhesive will suffice, but you may increase the number of drops according to the size of the gauge. Use the adhesive nozzle to spread the adhesive over the back surface thinly and uniformly.

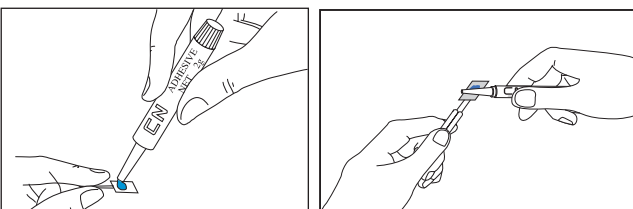

## 6. Curing and pressing

Place the gauge on the position, place a polyethylene sheet onto it and press down on the gauge constantly using your thumb or a gauge clamp. This should be done quickly as the curing process is completed very fast. The curing time varies depending on the gauge, test specimen, temperature, humidity and pressing force. The curing time under normal conditions is 20-60 seconds.

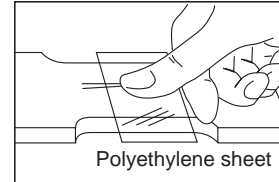

## 7. Raising gauge leads

After the adhesive beneath the polyethylene sheet has been perfectly cured, raise the gauge leads. Raise the leads up to a bit inside the gauge base while pressing down the foot of the leads by tweezers not to damage the leads.

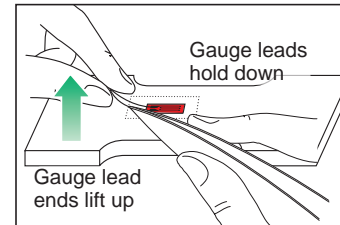

## 8. Bonding connecting terminals

Bond the terminal close to the gauge base.

Foil type connecting terminals

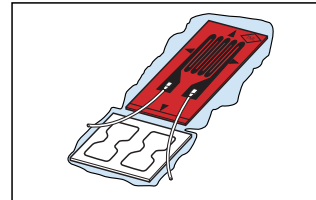

## 9. Soldering the gauge leads

Place the gauge leads on the gauge terminal with a little slack and apply solder so that the metal foil of terminal is covered with the solder. An excess gauge leads should be twisted off by tweezers.

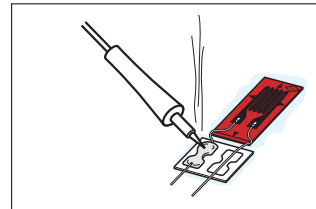

## 10. Soldering leadwires

It is recommended to plate the exposed core wires of the extension leadwires with solder preliminarily.

Solder the end of leadwire to the terminals. Take care not to excessively heat the terminal to peel off the metal foil.

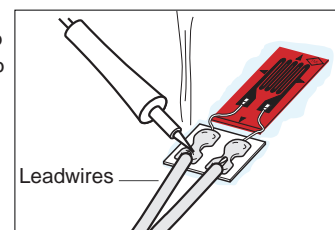



# PRIMARY INSTALLATIONS - Overcoating strain gauges

## Water- and Moisture-proofing with SB tape and VM tape

### Requirement in strain gauge coatings

- Excellent resistance to moisture and water and good electrical insulation
- Good adhesion to the strain gauge, leadwires and test specimen surface
- No constriction of the test specimen

### SB tape

Butyl rubber  
 Temperature : -30 to +80°C  
 Contents : 10mm×3mm  
 5m long/roll

### VM tape

Butyl rubber  
 Temperature : -20 to +80°C  
 Contents : 38mm×1mm  
 6m long/roll

Both of the SB and VM tapes are butyl rubber tape generally referred to as pressure-sensitive adhesive. These coating tapes are applied by being pressed onto the test specimen, and they provide excellent resistance to moisture and water.



## Example for leadwire integrated strain gauge

### First coating with SB tape

Trimming the SB tape  
 With scissors, cut off one piece of tape large enough to cover the coating area and another piece 5mm to 10mm in length to fit under the leadwires.

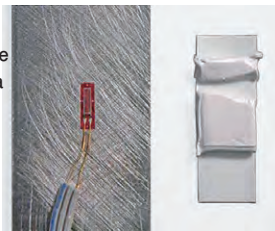

### Finish coating with VM tape

Cut a piece of VM tape slightly larger than the layer of SB tape coating and press it down onto the place so that the first coating is fully covered by the VM tape.



### Under-laying

Lift up the leadwires and press the smaller piece of tape onto the test specimen surface under the leadwires.



### Overall coating

Press the leadwires back down onto the piece of SB tape and then press the larger piece of coating tape down onto the strain gauge.





# STRAIN GAUGE INSTALLATION

TML strain gauge series are roughly classified into 4 types depending on the method of installation.

## 1. Adhesive bonding type

In general, most of strain gauges are installed on the surface of test specimen with adhesive. Measurement is possible as far as the specimen material is bondable with adhesive. This method can be applied to various materials including metal, concrete, wood and composite material. After installation, coatings should be applied to protect the strain gauges and leadwires from various environmental conditions. The availability of this bonding type depends on the operating temperature of adhesive. The maximum operating temperature is 300°C.

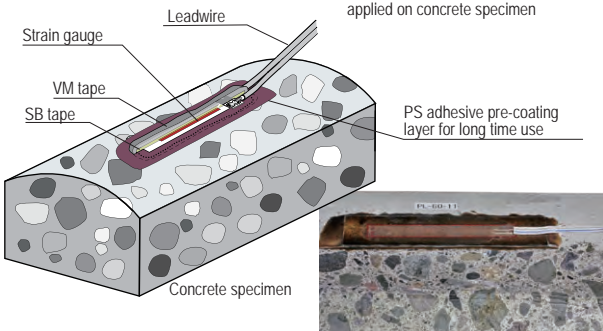
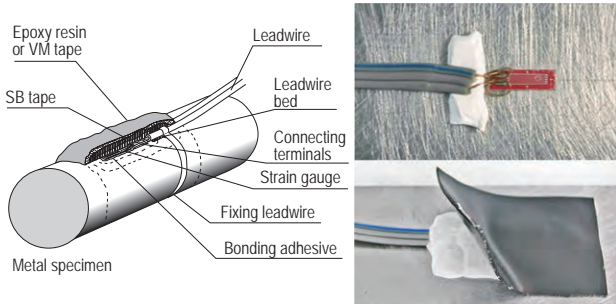

## 2. Electrical Spot weldable type

The strain gauge of this type is fully encapsulated in a corrosion-resisting metal tube for use in various conditions, such as gas-filled and underwater environments. It is constructed heat resistive, and the installation is made by electrical spot welding which maintains excellent fixation even in high temperature. The operating temperature range is from -196°C to +800°C. The spot welder W-50RC is developed exclusively for installation of strain gauges of this type, and it can be used without any qualifications or special skill. Naturally, the specimen material must be a metal which allows electrical spot welding.

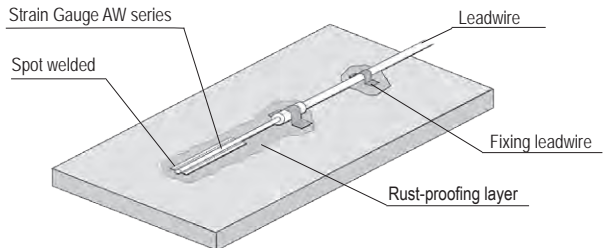

## 3. Frictional gauge type (Re-usable type)

This gauge consists of a soft rubber layer on its contact surface and a magnet which presses the strain gauge against the specimen surface by magnetic force. It measures strain by friction which is caused between the contact surface of strain gauge and the measurement surface of the metal specimen. It has the advantage of being usable repeatedly because it is attached by magnetic force without using adhesive. Since the measurement point can be moved easily, it is useful for preparatory or supplemental measurement. The maximum operating temperature is 60°C because of adopting magnetic force.

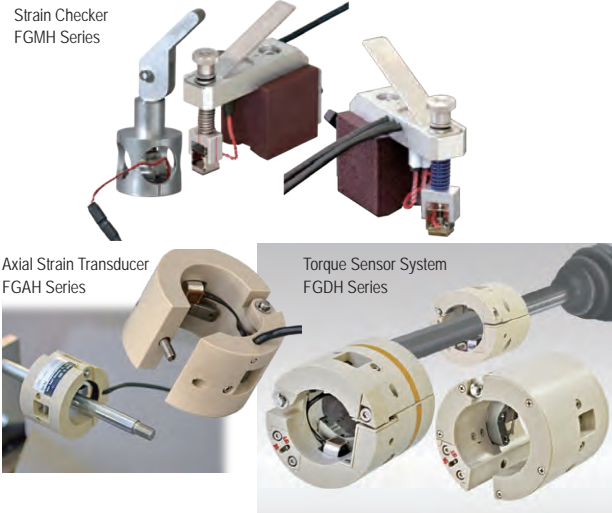
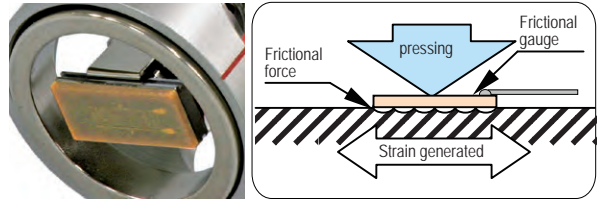

## 4. Internal strain measurement using embedment type

Above strain gauges of three types measure surface strains of test specimen. This strain gauge measures internal strain of concrete, mortar or asphalt by being embedded into the material before its hardening. It makes possible with measurement in the early stage of hardening of the material. Some series of this type are applicable to measurement in asphalt in high temperature of 200°C. We also have a method to measure axial force of bolt by embedding a bolt strain gauge which is specially prepared for this purpose.

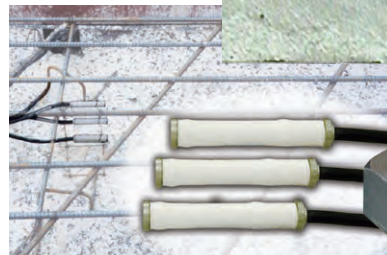

Bolt gauge BTM series installed into bolt with bonding adhesive

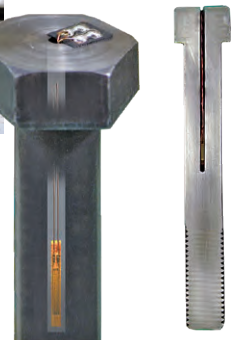





# STRAIN GAUGE EXTENSION LEADWIRES

Strain gauges are connected to strain measuring instruments using extension leadwires. We offer various types of leadwires to be selected depending on the usage conditions. In addition, most of strain gauges are available with extension leadwires preattached at our factory. Those leadwire-integrated strain gauges greatly save the leadwire connection works during the strain gauge installation. Please feel free to contact our company or local representative for the extension leadwires and the leadwire-integrated strain gauges.

## Standard leadwire length for leadwire-integrated strain gauges

Standard length of our integral leadwires is 1m, 3m and 5m except enamel leadwires. The standard length of enamel leadwires are 0.3m, 0.5m and 1m. Other lengths than the standard length may be available on request. The enamel leadwires are not available in a length more than 1m.

- OPTION -F Leadwire with CE marking
- Leadwire with CE marking (compliant to RoHS2 Directive)
- Identification code "-F" is appended to the type number of the leadwire.

## Leadwire selection

### ¶ Vinyl leadwires









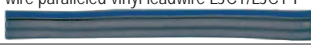
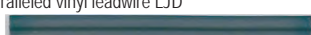

Vinyl leadwires are widely used as strain gauge leadwires, and are available in a variety of types. Because the vinyl insulation can be colored, these wires allow color-coding for rosette gauges. Stranded core wires are flexible and easy to handle, and allow easy wire connection and terminal attachment.

#### •Small diameter vinyl wires (Code to order -LH, -LHT)

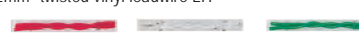
These leadwires feature a thin vinyl insulated materials and small diameter core wires to achieve an outside diameter of 0.4mm. They are used for wiring in tight spaces. The stranded wires are flexible and minimize breakage due to repeated bending.

#### •Shielded vinyl wires (Code to order -LTSA, -LTSB)

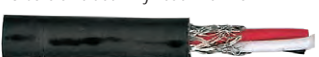
These are 3-core wires with shield made of aluminium foil or braided copper wire. The outer insulation is made of vinyl. These leadwires offer a noise shielding function.

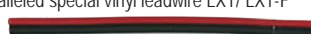
Type number of leadwires (Option code -F for CE marking)	Core/Diameter (cross section) (mm)	Applicable temperature	Total resistance of lead wire	Outer insulated dimensions (mm)	Length per roll	Colors
0.08mm <sup>2</sup> paralleled vinyl lead wire LJB/LJB-F 	7/0.12 (0.08mm <sup>2</sup> )	-20~+80°C	0.44Ω/m	1.1×2.2	200m	Red, White, Green, Black, Yellow Blue, Red-White
0.08mm <sup>2</sup> 3-wire paralleled vinyl leadwire LJBTL/LJBTL-F 	7/0.12 (0.08mm <sup>2</sup> )			1.1×3.3		White wire and whichever color Blue, Orange, Red, Green, Black or Yellow stripe is selectable. (*)
0.11mm <sup>2</sup> paralleled vinyl lead wire LJC/LJC-F 	10/0.12 (0.11mm <sup>2</sup> )	-20~+80°C	0.32Ω/m	1.4×2.8	200m	Grey
0.11mm <sup>2</sup> 3-wire paralleled vinyl leadwire LJCT/LJCT-F 	10/0.12 (0.11mm <sup>2</sup> )			1.4×4.2		Grey, One wire with Blue stripe (*)
0.3mm <sup>2</sup> paralleled vinyl leadwire LJD 	12/0.18 (0.3mm <sup>2</sup> )	-20~+80°C	0.12Ω/m	1.9×3.8	200m	Grey
0.3mm <sup>2</sup> 3-wire paralleled vinyl leadwire LJDT 	12/0.18 (0.3mm <sup>2</sup> )			1.9×5.7		White, One wire with Red stripe (*)
0.02mm <sup>2</sup> twisted vinyl leadwire LH 	5/0.07 (0.02mm <sup>2</sup> )	-20~+100°C	1.8Ω/m	Φ0.8	—	Red, Green, White
0.02mm <sup>2</sup> 3-wire twisted vinyl leadwire LHT/LHT-F 	5/0.07 (0.02mm <sup>2</sup> )			Φ1.0		Red-Green-White
3.2mm-dia. 2-core shielded vinyl leadwire LS 	7/0.12 (0.08mm <sup>2</sup> )	-20~+80°C	0.44Ω/m	Φ3.2	200m	Outer : White Core wire : Green-Green
3mm-dia. 3-core shielded vinyl leadwire LTSA 	7/0.12 (0.08mm <sup>2</sup> )	-20~+80°C	0.44Ω/m	Φ3	200m	Outer : Red, White or Green Core wire : Red-Black-White
5mm-dia. 3-core shielded vinyl leadwire LTSB 	7/0.26 (0.3mm <sup>2</sup> )	-20~+80°C	0.1Ω/m	Φ5	200m	Outer : Black Core wire : Red-Black-White
0.08mm <sup>2</sup> polypropylene 4-wire paralleled leadwire LQM/ LQM-F 	7/0.12 (0.08mm <sup>2</sup> )	-20~+100°C	0.44Ω/m	0.9×4.0	200m	White, One wire with Red, Black, or Blue stripe
3-wire paralleled special vinyl leadwire LXT/ LXT-F 	7/0.12 (0.08mm <sup>2</sup> )	-20~+150°C	0.44Ω/m	0.9×2.7	200m	Red-Black-White

N.B.: \* Stripe is for distinction of independent wire in quarter bridge 3-wire connection.



# STRAIN GAUGE EXTENSION LEADWIRES

## ¶ Enamel leadwires

Enamel leadwires have a single core insulated with a resin. Heat resistance and handling methods vary depending on resin. Because the wire mass and diameter are small, enamel leadwires are used for strain measurement of rotating specimens and/or measurement of multiple points located in close proximity. Since the enamel leadwire contains one core covered with a thin resin, it must be handled with care.

## ·Polyurethane leadwires



Polyurethane leadwires allow easy post-processing because the resin can be removed with a soldering iron. The resin is not strong, therefore, polyurethane wires must be handled with special care.

## ·Polyester leadwires

Polyester leadwires are harder than polyurethane wires. It cannot be removed with a soldering iron.

## ·Polyimide leadwires

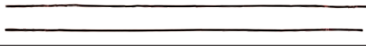
Polyimide leadwires are harder than the polyester wire. A soldering iron cannot be used for post-processing.

Leadwire type	Core/Diameter(*1)	Applicable temperature	Total resistance of leadwire	Outer insulated dimensions	Colors
Polyurethane leadwire(*2) LP/LP-F 	1/0.14	-10~+120°C	2.5Ω/m	Φ0.16mm	Red, Brown, Green
	1/0.18		1.5Ω/m	Φ0.20mm	
Polyester leadwire(*2) LU/LU-F 	1/0.14	-196~+200°C	2.5Ω/m	Φ0.16mm	Brown
	1/0.18		1.5Ω/m	Φ0.20mm	
Polyimide leadwire LE/LE-F 	1/0.14	-269~+300°C	2.5Ω/m	Φ0.16mm	Brown
	1/0.18		1.5Ω/m	Φ0.20mm	

N.B.: \*1: Two types with different core diameters, which are 0.14 mm and 0.18 mm, are available for each enamel wire.



\*2: Attachment of lead wire cannot be performed on stacked-type two-element or three-element gauges.

## ¶ Cross-linked Vinyl leadwires

The cross-linked vinyl insulation provides improved resistance against environmental elements. It is often used for underwater measurement in ordinary temperature.



## ¶ Cross-linked Polyethylene leadwires

The cross-linked polyethylene leadwire offers higher durability than the cross-linked vinyl leadwire. Cross-linked polyethylene leadwires can be used in steam, warm water and concrete with virtually no insulation degradation.

Leadwire type	Core/Diameter (Cross section)	Applicable temperature	Total resistance of leadwire	Outer insulated dimensions	Length per roll	Colors
2-wire twisted cross-linked vinyl leadwire LJRA 	7/0.16 (0.14mm <sup>2</sup> )	-20~+100°C	0.24Ω/m	Φ3.0mm	—	White
3-wire twisted cross-linked vinyl leadwire LJRTA 	7/0.127 (0.09mm <sup>2</sup> )	-20~+100°C	0.4Ω/m	Φ2.0mm	200m	Red-Green-Black
3-wire twisted cross-linked polyethylene leadwire LJQTA 	7/0.127 (0.09mm <sup>2</sup> )	-65~+125°C	0.4Ω/m	Φ2.0mm	—	Red-Yellow-Black Red-Yellow-White Red-Yellow-Blue

### ¶ Special leadwire for temperature-integrated gauge









Special leadwire for temperature-integrated gauge consists of 2-core copper and 1-core constantan. To extend this wire, the exclusive leadwire should be applied properly.

Leadwire type	Core/Diameter (Cross section)	Applicable temperature	Total resistance of leadwire	Outer insulated dimensions	Length per roll	Colors
Temperature-integrated 3-wire paralleled vinyl leadwire TLJBT/TLJBT-F 	7/0.12 (0.08mm <sup>2</sup> )	-20~+80°C	0.44Ω/m <sup>(*1)</sup>	1.2×3.6mm	—	Red-White-Blue
Temperature-integrated 3-wire twisted fluorinated resin (FEP) leadwire 6FB□TLT <sup>(*2)</sup> 	1/0.2	-269~+200°C	1.2Ω/m <sup>(*1)</sup>	Φ1.1mm	—	Red-White-Blue

N.B.: \*1: Total resistance of copper wire per meter  
\*2: □ is filled with the lead wire length in meter  
\*: For the method of connection to a strainmeter, refer to the operation manual of the strainmeter.

### ¶ Fluorinated resin leadwire

With a fluorinated resin leadwires, these leadwires can be used in a wide range of temperature from extremely low to high temperatures. Fluorinated resin resists most chemicals. A surface treatment (tetra-etching) is not required by 6FAS\_LT(-F).

Leadwire type	Core/Diameter (Cross section)	Applicable temperature	Total resistance of leadwire	Outer insulated dimensions	Length per roll	Suffix code of leadwire	Colors
3-wire twisted fluorinated resin (FEP) leadwire 6FA□LT/6FA□LT-F <sup>(*1)(*3)</sup> 	7/0.18 (0.18mm <sup>2</sup> )	-269~+200°C	0.2Ω/m	Φ2.0mm	100m	-6FA_LT	Red-Green-Blue
3-wire twisted fluorinated resin (FEP) leadwire 6FAS□LT/6FAS□LT-F <sup>(*1)(*3)(*4)</sup> 	7/0.18 (0.18mm <sup>2</sup> )	-269~+200°C	0.2Ω/m	Φ2.0mm	100m	-6FAS_LT	Red-Green-Blue
3-wire twisted fluorinated resin (FEP) single-core leadwire 6FB□LT/6FB□LT-F <sup>(*1)(*3)</sup> 	1/0.2	-269~+200°C	1.2Ω/m	Φ1.1mm	—	-6FB_LT	Red-Green-Blue
3-wire twisted fluorinated resin (FEP) leadwire 6FC□LT/6FC□LT-F <sup>(*1)(*3)</sup> 	7/0.08 (0.04mm <sup>2</sup> )	-269~+200°C	1.1Ω/m	Φ1.0mm	—	-6FC_LT	Red-Black-White
3-wire twisted fluorinated resin (FEP) leadwire 6FCS□LT/6FCS□LT-F <sup>(*1)(*3)(*4)</sup> 	7/0.08 (0.04mm <sup>2</sup> )	-269~+200°C	1.1Ω/m	Φ1.0mm	—	-6FCS_LT	Red-Black-White
3-wire twisted fluorinated resin (FEP) leadwire 6FD□LTS/6FD□LTS-F <sup>(*1)(*3)</sup> 	7/0.08 (0.04mm <sup>2</sup> )	-269~+200°C	1.1Ω/m	Φ1.5mm	—	-6FD_LTS	Red-Black-White
3-wire twisted fluorinated resin (PTFE) leadwire 4FA□LT/4FA□LT-F <sup>(*1)(*3)</sup> 	7/0.16 (0.14mm <sup>2</sup> )	-269~+260°C <sup>(*2)</sup>	0.24Ω/m	Φ1.9mm	100m	-4FA_LT	Red-Grey-White
3-wire twisted fluorinated resin (PTFE) single-core leadwire 4FB□LT/4FB□LT-F <sup>(*1)(*3)</sup> 	1/0.2	-269~+260°C <sup>(*2)</sup>	1.05Ω/m	Φ1.1mm	—	-4FB_LT	Red-Black-White

N.B.: \*1: □ is filled with the lead wire length in meter  
\*2: PTFE leadwire is available for use in 300°C for a short term  
\*3: Suffix code LT(CT) means connecting terminal joint, while LT(TA) means insulation with film  
\*4: for easy application of coating: Surface treatment (tetra-etching) is not required when applying coating



# HOW ARE INTEGRAL LEADWIRES JOINED

Most TML strain gauges are available with extension leadwires pre-attached for customer convenience. We have several methods for connecting leadwires to be chosen depending on conditions such as the type of strain gauge and leadwire, measurement environments and so on.

## Different joints

### ·Integral type

A vinyl leadwire is jointed to polyimide insulated gauge leads of a strain gauge. The solder joints are covered with the vinyl insulation of the leadwire. This is our standard method of integral leadwire attachment.

### ·Heat-shrinkable tubing

A soldered joint between gauge leads and leadwire is protected with a heat shrinkable tube. The heat shrinkable tubes are available in three ratings of temperature among 80°C, 200°C and 260°C.

### ·Connecting terminals joint type

Gauge leads and leadwires are jointed using foil shape connecting terminals. Measurement in high temperature is possible by using a high temperature solder with melting point of 300°C or more for the joint.

### ·Insulation film type

A soldered joint between gauge leads and leadwires is covered with an insulation film of glass cloth base. The film is resistive to heat up to 300°C, so this method is suited to measurement in high temperature.

### ·Direct type

A vinyl leadwire is jointed directly to gauge leads, which are made of nickel plated copper. The solder joints are covered with vinyl insulation of a leadwire up to the end of the gauge base.

### Integral type

	Cross section	Leadwire				Code to order
		Construction	Dimension			
			a	b		
Vinyl leadwire 2-wire		2-wire paralleled	7/0.12	1.1	2.2	-LJB/-LJB-F
		10/0.12	1.4	2.8	-LJC/-LJC-F	
		2-wire twisted	5/0.07	0.4	-	-LH
Vinyl leadwire 3-wire		3-wire paralleled	7/0.12	1.1	3.3	-LJBT/-LJBT-F
		10/0.12	1.4	4.2	-LJCT/-LJCT-F	

The option code "-F" appended to the leadwire code indicates that lead-free solder is used for the leadwire.

### Heat-shrinkable tubing

	Cross section	Leadwire				Heat-shrinkable tube			Code to order
		Construction	Dimension		Dimension				
			a	b	L	H	W		
Vinyl leadwire 2-wire		2-wire paralleled	12/0.18	1.9	3.8	11	3	6	-LJD
Vinyl leadwire 3-wire		3-wire paralleled	12/0.18	1.9	5.7	11	3	7	-LJDT
		3-wire twisted	5/0.07	0.4	-	5	0.8	1.6	-LHT -LHT-F
Cross-linked Vinyl leadwire 2-wire		Cross-linked vinyl 2-wire twisted	7/0.16	0.9	-	11	2	4	-LJRA
Cross-linked Vinyl leadwire Cross-linked Polyethylene leadwire 3-wire		Cross-linked vinyl 3-wire twisted	7/0.127	1.1	-	11	2	4	-LJRTA
		Cross-linked polyethylene 3-wire twisted	7/0.12	0.8	-	11	2	4	-LJQTA -LJQTA-F

The option code "-F" appended to the leadwire code indicates that lead-free solder is used for the leadwire.

## Heat-shrinkable tubing

Gauge lead length approx. 15mm

	Construction	Dimension	Heat-shrinkable tube			Code to order	
			Dimension				
			L	H	W		
3-core shielded Vinyl leadwire 3-wire	3-wire twisted	7/0.12	Φ3	10	2	4	-LTSA -LTSA-F
		7/0.26	Φ5	12.5	3	6	-LTSB
High temperature use Fluorinated resin (FEP) leadwire 3-wire	FEP (Fluorinated-ethylenepropylene) 3-wire twisted	1/0.2	Φ1.1	11	2	2	-6FB <sup>o</sup> LT -6FB <sup>o</sup> LT-F
		7/0.18	Φ2	11	3	4	-6FAS <sup>o</sup> LT -6FAS <sup>o</sup> LT-F
High temperature use Fluorinated resin (PTFE) leadwire 3-wire	PTFE (Polytetrafluoroethylene) 3-wire twisted	1/0.2	Φ1.1	11	2	2	-4FB <sup>o</sup> LT -4FB <sup>o</sup> LT-F
		7/0.16	Φ1.9	11	2.5	4	-4FA <sup>o</sup> LT -4FA <sup>o</sup> LT-F

## Connecting terminals joint type

Fluorinated resin (PTFE) leadwire

Special construction

	Construction	Dimension	Code to order	
			L	H
3-wire	PTFE (Polytetrafluoroethylene) 3-wire twisted	1/0.2	Φ1.1	-4FB <sup>o</sup> LT(CT) -4FB <sup>o</sup> LT-F(CT)

## Insulation film type

Fluorinated resin (PTFE) leadwire

Special construction

	Construction	Dimension	Heat-shrinkable tube			Code to order	
			Dimension				
			L	H	W		
3-wire	PTFE (Polytetrafluoroethylene) 3-wire twisted	7/0.16	Φ1.9	13	1.5	4	-4FA <sup>o</sup> LT(TA) -4FA <sup>o</sup> LT-F(TA)

N.B.:

Figures in Leadwire construction column show "Number of cores/ Diameter of one conductor leadwire in mm". For example, "7/0.12" represents "7core / 0.12mm diameter for one conductor leadwire". All dimensions of the Leadwire Heat-shrinkable tube and Film are approximate values in mm.

"o" in the "Code to order" is filled with the leadwire length in meter.



# HOW ARE INTEGRAL LEADWIRES JOINED

## Leadwire colors of 3-element Rosette strain gauge

These are generally used leadwires.

The option code "-F" appended to the leadwire type indicates that lead-free solder is used for the leadwire.

7/0.12 (0.08mm<sup>2</sup>) Paralleled vinyl leadwire  
Suffix code : -LJB/-LJB-F

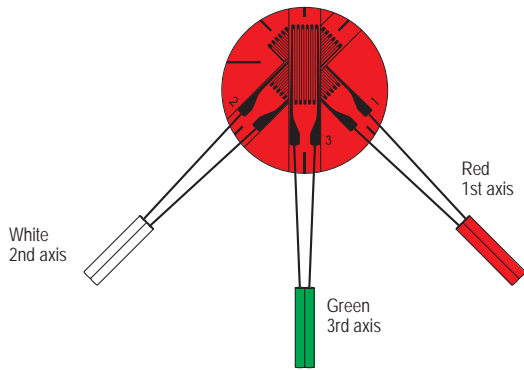

7/0.12 (0.08mm<sup>2</sup>) 3-wire Paralleled vinyl leadwire  
Suffix code : -LJBT/-LJBT-F

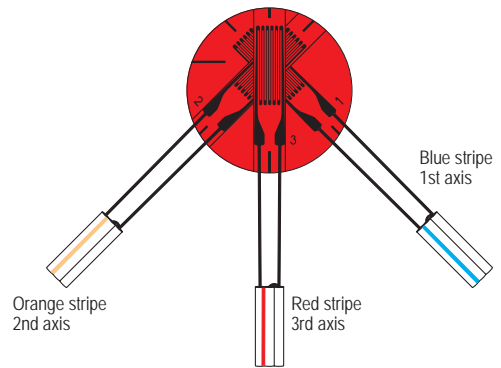

7/0.127 (0.09mm<sup>2</sup>) 3-wire twisted cross-linked polyethylene leadwire  
Suffix code : -LJQTA/-LJQTA-F

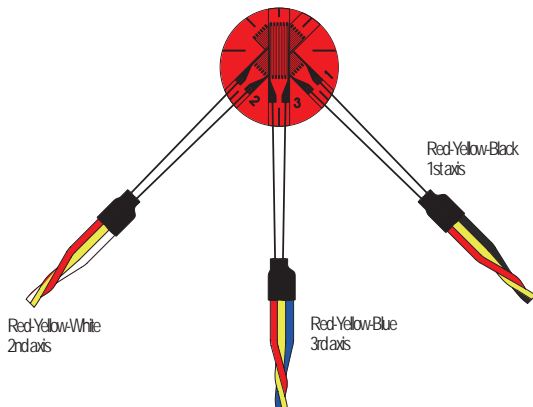

5/0.07 (0.02mm<sup>2</sup>) 2-wire twisted vinyl leadwire  
Suffix code : -LH

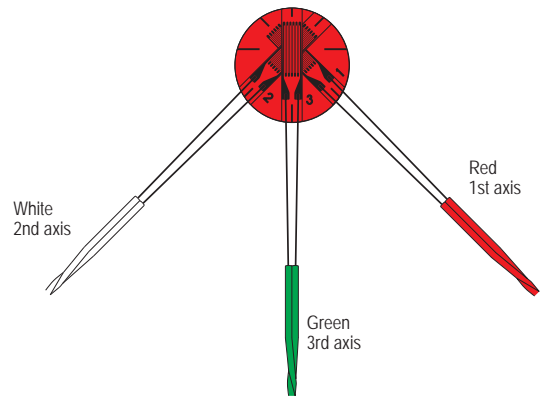

3mm-dia. 3-core shielded vinyl leadwire  
Suffix code : -LTSA/-LTSA-F

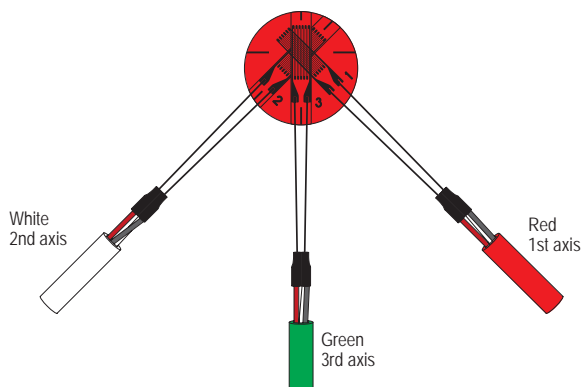

7/0.12 (0.08mm<sup>2</sup>) Paralleled vinyl leadwire  
Suffix code : -LDDBB-F

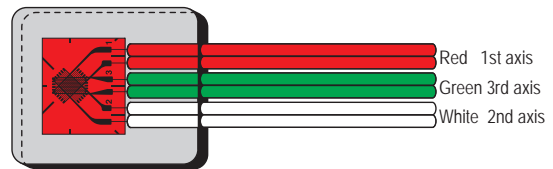

7/0.12 (0.08mm<sup>2</sup>) 3-wire Paralleled vinyl leadwire  
Suffix code : -LDBTB-F

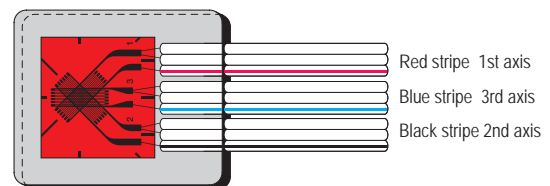

## Insulated leadwire colors

These are generally used leadwires.

The option code “-F” appended to the leadwire type indicates that lead-free solder is used for the leadwire.

### Stress concentration measurement use

FXV 5-element single axis integrated

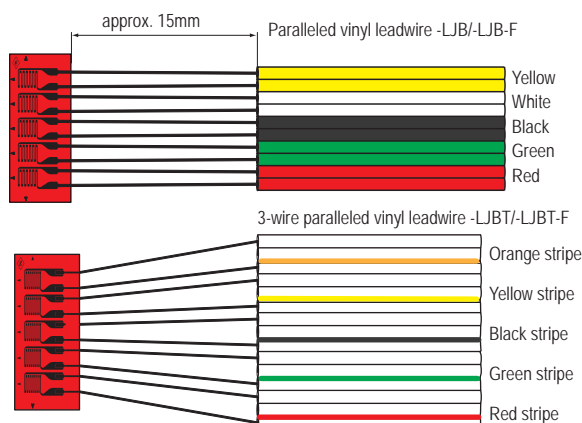

Color stripes are marked on independent wire of each axis with 3-wire system.

FYV 5-element single axis integrated

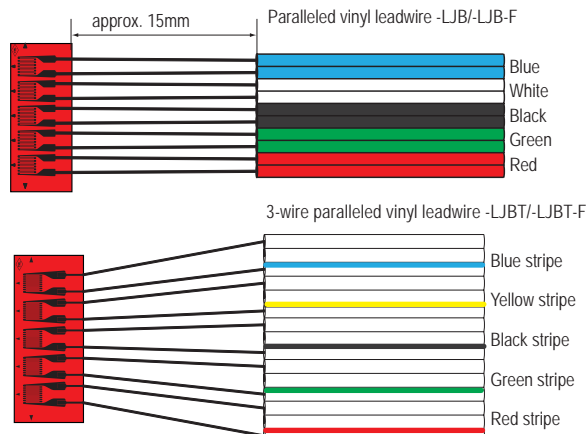

Color stripes are marked on independent wire of each axis with 3-wire system.

FBXV 5-element single axis integrated

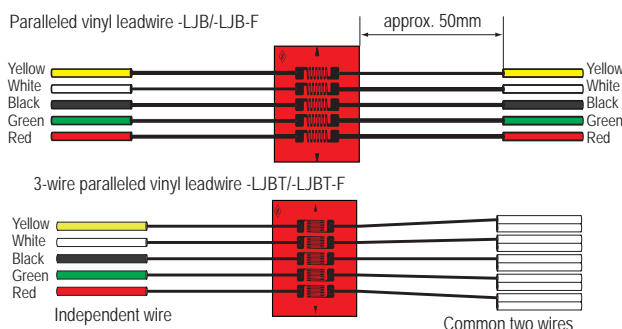

FBYV 5-element single axis integrated

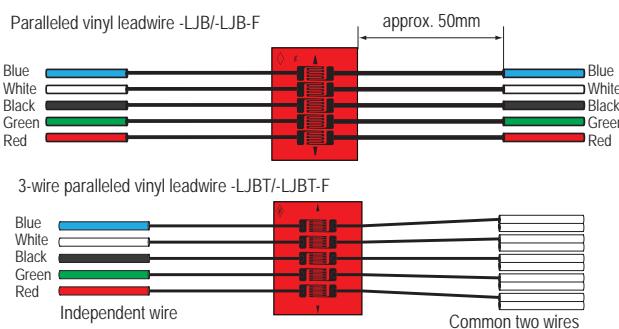

### Stress concentration measurement use

FCV 10-element 2-axis cross integrated

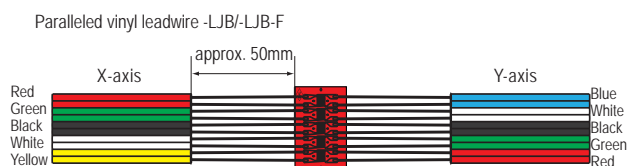

3-wire paralleled vinyl leadwire -LJBT/-LJBT-F

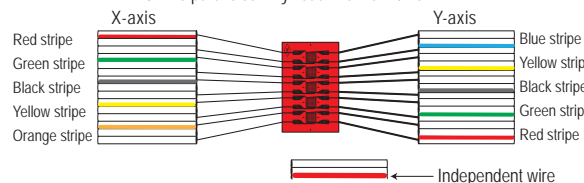

Color stripes are marked on independent wire of each axis with 3-wire system.

### Torque measurement use (Integral type) LDBT

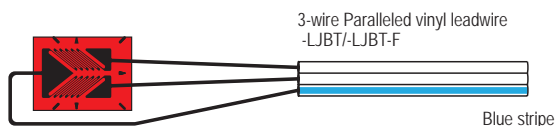

### Temperature gauge

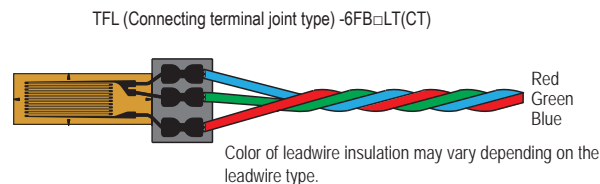

### Single element strain gauge with different leadwire

Color of leadwire insulation may vary depending on the leadwire type.

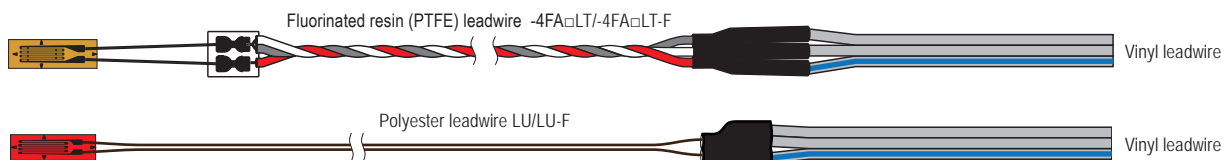



# Combination use of strain gauges and dedicated leadwires

Strain Gauge

EXTENSION LEADWIRES

Combination use of strain gauges and dedicated leadwires

### Option -F: Lead-free solder

Use of lead-free solder is selectable for strain gauges and leadwires. When it is selected, the option code "-F" is added to the type number of strain gauge and leadwire separately.

The GOBLET and PF/P/YEF/YF/PFLW/PLW/UBF/FAC series gauges are only available with the use of lead-free solder because they are CE marked with their exclusive leadwires. The CF/CEF/ZF/EF/BTM series gauges are CE marked because they use high melting point solder and RoHS2 Directive is not applied.

A strain gauge with option code "-F" is a RoHS-compliant product. Since the issuance of technical document is required for the RoHS compliance, please contact us for the details of CE marking availability for the product.

Strain Gauge Series	CE compliance	Operating temperature range °C	Temperature compensation range °C	The table below shows the maximum operating temperature of the strain gauge in combined use with the dedicated leadwire. (°C)													
				Leadwire name	Paralleled vinyl leadwire	3-wire paralleled vinyl leadwire	Paralleled vinyl leadwire	3-wire paralleled vinyl leadwire	Paralleled vinyl leadwire	3-wire paralleled vinyl leadwire	Twisted vinyl leadwire	3-wire twisted vinyl leadwire	Twisted vinyl leadwire	3.2mm-dia. 2-core shielded vinyl leadwire	3mm-dia. 3-core shielded vinyl leadwire	5mm-dia. 3-core shielded vinyl leadwire	
F	Partly (-F)	-196 ~ +150	+10 ~ +100	80	80	80	80	80	80	80	80	-	-	80	80		
<b>GOBLET</b>	CE	-196 ~ +150	+10 ~ +100	80	80	80	80	-	-	-	80	-	-	80	80		
PF	CE	-20 ~ +80	+10 ~ +80	80	80	80	80	-	-	-	-	-	-	80	80		
P	CE	-20 ~ +80	+10 ~ +80	80	80	80	80	-	-	-	-	-	-	80	80		
FLM	Non	-20 ~ +80	+10 ~ +80	-	80	-	80	-	80	-	80	-	-	80	80		
QMF	CE	-30 ~ +200	0 ~ +150	-	-	-	-	-	-	-	-	80	80	80	-		
MF(Single)	Non	-20 ~ +80	-	-	-	-	-	-	-	-	-	80	80	80	-		
MF(Rosette)	Non	-20 ~ +200	-	-	-	-	-	-	-	-	-	-	80	-	-		
<b>YEF GOBLET</b>	CE	-30 ~ +80	-	80	80	80	80	-	-	-	80	-	-	80	80		
YF	CE	-20 ~ +80	-	80	80	80	80	80	80	80	80	-	-	-	-		
YHF	CE	-30 ~ +80	-	80	80	80	80	80	80	80	80	-	-	-	-		
<b>LF GOBLET</b>	CE	-30 ~ +80	+10 ~ +80	80	80	80	80	-	-	-	80	-	-	80	80		
PFLW	CE	-20 ~ +80	+10 ~ +80	80	80	80	80	80	80	80	80	-	-	80	80		
PLW	CE	-20 ~ +80	+10 ~ +80	80	80	80	80	80	80	80	80	-	-	80	80		
<b>GF GOBLET</b>	CE	-30 ~ +80	+10 ~ +80 (approx.)	80	80	80	80	-	-	-	80	-	-	80	80		
<b>BF GOBLET</b>	CE	-30 ~ +200	+10 ~ +80	80	80	80	80	-	-	-	80	-	-	80	80		
UBF	CE	(Static): -30 ~ +120 (Dynamic): -30 ~ +150	-	80	80	80	80	80	80	80	80	-	-	80	80		
DSF	Non	-60 ~ +200	-	80	80	80	80	80	80	80	80	-	-	80	80		
CF	CE	-269 ~ +80	-196 ~ +80 (approx.)	80	80	80	80	80	80	80	80	-	-	80	80		
CEF	CE	-269 ~ +200	-196 ~ +80 (approx.)	80	80	80	80	80	80	80	80	-	-	80	80		
QF	Partly (-F)	-20 ~ +200	+10 ~ +100	80	80	80	80	80	80	80	80	-	-	80	80		
<b>GOBLET</b>	CE	-30 ~ +200	+10 ~ +100	80	80	80	80	-	-	-	80	-	-	80	80		
ZF	CE	-20 ~ +300	+10 ~ +100	80	80	80	80	80	80	80	80	-	-	80	80		
EF(Single)	CE	-196 ~ +300	+10 ~ +150	80	80	80	80	80	80	80	80	-	-	80	80		
EF(Rosette)	CE	-196 ~ +200	0 ~ +150	80	80	80	80	80	80	80	80	-	-	80	80		
BTM	CE	-10 ~ +80	-	80	80	80	80	-	-	-	-	-	-	-	-		
FAC	CE	-30 ~ +80	-	-	-	-	-	-	-	-	-	-	-	-	-		
TF	(-F)	-20 ~ +200	-	-	80	-	80	-	-	-	-	-	-	-	-		

Remarks: Strain gauges of the following series are available only with the dedicated leadwires which are the most suited to the series. Please also refer to the description about each series in this catalog. The option -F (use of lead-free solder) is available. To specify this option, attach the suffix "-F" to the end of each type number of the dedicated leadwire.

Series WF	Operating temperature	0 ~ +80°C	Leadwire : LDBB-F	Parallel vinyl leadwire
			LDBTB-F	3-wire paralleled vinyl leadwire 7/0.12(0.08mm <sup>2</sup> )
Series WFLM	Operating temperature	-20 ~ +80°C	Leadwire : LJQTA	3-wire twisted cross-linked polyethylene leadwire 2 meters 7/0.127(0.09mm <sup>2</sup> )
Note) WFLM series is not available with option -F.				
Series PMF	Operating temperature	-20 ~ +60°C	Leadwire : LJRJA	3-wire twisted cross-linked vinyl leadwire 2 meters 7/0.127(0.09mm <sup>2</sup> )
Temperature-integrated PMF			Leadwire : TLJBT	3-wire parallel vinyl leadwire 7/0.12 (0.08mm <sup>2</sup> )
Series PMFLS	Operating temperature	-20 ~ +60°C	Leadwire : LTSC	4-wire shielded Chloroprene cable (3-wire connection) 2 meters, 6mm dia.



	Polypropylene 4-wire parallel leadwire (with modular plug)	3-wire parallel special vinyl leadwire	2-wire twisted cross-linked vinyl leadwire	3-wire twisted cross-linked vinyl leadwire	3-wire twisted cross-linked polyethylene leadwire	Temperature-integrated 3-wire parallel vinyl leadwire	Temperature-integrated 3-wire twisted fluorinated resin (FEP) single-core leadwire	Polyurethane leadwire	Polyester leadwire	Polyimide leadwire	3-wire twisted fluorinated resin (FEP) leadwire	3-wire twisted fluorinated resin (FEP) leadwire (Surface treatment (tetra-etching) is not required)	3-wire twisted fluorinated resin (FEP) single-core leadwire	3-wire twisted fluorinated resin (FEP) leadwire	3-wire twisted fluorinated resin (FEP) leadwire (Surface treatment (tetra-etching) is not required)	1.5mm dia. 3-core shielded fluorinated resin (FEP) leadwire	3-wire twisted fluorinated resin (PTFE) leadwire	3-wire twisted fluorinated resin (PTFE) single-core leadwire	
	LQM	LXT	LJRA	LJRJA	LJQTA	TLJBT	6FB □TLT	LP	LU	LE	6FA □LT	6FAS □LT	6FB □LT	6FC □LT	6FCS □LT	6FD □LTS	4FA □LT	4FB □LT	
	-F	-F	-F	-F	-F	-F	-F	-F	-F	-F	-F	-F	-F	-F	-F	-F	-F	-F	
	7/0.12	7/0.12	7/0.16	7/0.127	7/0.127	7/0.12	1/0.2	1/0.14 1/0.18	1/0.14 1/0.18	1/0.14 1/0.18	7/0.18	7/0.18	1/0.2	7/0.08	7/0.08	7/0.08	7/0.16	1/0.2	
	0.08	0.08	0.14	0.09	0.09	0.08					0.18	0.18		0.04	0.04	0.04	0.14		
	-20 ~ +100	-20 ~ +150	-20 ~ +100	-20 ~ +100	-65 ~ +125	-20 ~ +80	-269 ~ +200	-10 ~ +120	-196 ~ +200	-269 ~ +300	-269 ~ +200	-269 ~ +200	-269 ~ +200	-269 ~ +200	-269 ~ +200	-269 ~ +200	-269 ~ +260	-269 ~ +260	
	The table below shows the maximum operating temperature of the strain gauge in combined use with the dedicated leadwire. (°C)																		Strain Gauge Series
	100	150	100	100	125	80	150	120	150	150	150	150	150	150	150	-	150	150	F (-F)
	100	150	-	-	125	80	150	120	150	150	150	150	150	150	150	-	150	150	GOBLET
	80	80	-	-	80	80	-	80	80	80	-	-	-	-	-	-	-	-	PF
	80	80	-	-	80	-	-	80	80	80	-	-	-	-	-	-	-	-	P
	80	80	-	80	80	80	80	-	-	-	80	80	80	80	80	-	80	80	FLM
	-	-	-	-	-	-	-	-	-	-	-	-	-	-	-	200	-	-	QMF
	-	-	-	-	-	-	-	-	-	-	-	-	-	-	-	80	-	-	MF(Single)
	-	-	-	-	-	-	-	-	-	-	-	-	-	-	-	200	-	-	MF(Rosette)
	80	80	-	-	80	80	80	80	80	80	80	80	80	80	80	-	80	80	YEF GOBLET
	80	80	80	80	80	80	80	80	80	80	80	80	80	80	80	-	80	80	YF
	80	80	80	80	80	80	80	80	80	80	80	80	80	80	80	-	80	80	YHF
	80	80	-	-	80	80	80	80	80	80	80	80	80	80	80	-	80	80	LF GOBLET
	80	80	80	80	80	80	80	80	80	80	80	80	80	80	80	-	80	80	PFLW
	80	80	80	80	80	80	80	80	80	80	80	80	80	80	80	-	80	80	PLW
	80	80	-	-	80	80	80	80	80	80	80	80	80	80	80	-	80	80	GF GOBLET
	100	150	-	-	125	80	200	120	200	200	200	200	200	200	200	-	200	200	BF GOBLET
	100	120 150	100	100	120 125	80	120 150	120	120 150	120 150	120 150	120 150	120 150	120 150	120 150	-	120 150	120 150	UBF
	100	150	100	100	125	80	200	120	200	200	200	200	200	200	200	-	200	200	DSF
	80	80	80	80	80	80	80	80	80	80	80	80	80	80	80	-	80	80	CF
	100	150	100	100	125	80	200	120	200	200	200	200	200	200	200	-	200	200	CEF
	100	150	100	100	125	80	200	120	200	200	200	200	200	200	200	-	200	200	QF (-F)
	100	150	-	-	125	80	200	120	200	200	200	200	200	200	200	-	200	200	GOBLET
	100	150	100	100	125	80	200	120	200	300	200	200	200	200	200	-	260	260	ZF
	100	150	100	100	125	80	200	120	200	300	200	200	200	200	200	-	260	260	EF(Single)
	100	150	100	100	125	80	200	120	200	200	200	200	200	200	200	-	200	200	EF(Rosette)
	-	-	80	80	80	-	-	80	-	80	80	80	80	-	-	-	80	80	BTM
	-	-	-	-	-	-	-	80	-	80	-	-	-	-	-	-	-	-	FAC
	-	-	-	100	125	-	-	120	-	200	200	200	200	200	200	-	200	200	TF (-F)

Standard length of the leadwire is 1 m, 3 m or 5 m.

Designation of leadwire-integrated strain gauge exemplified

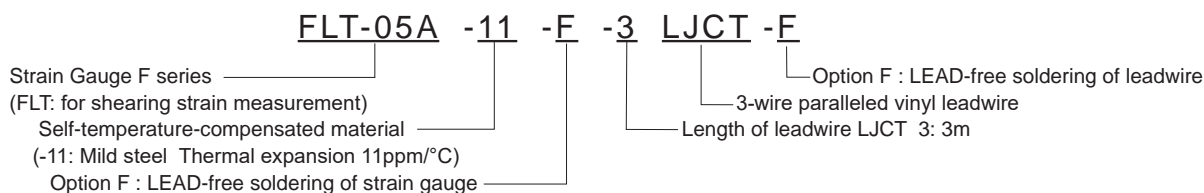



# GOBLET series

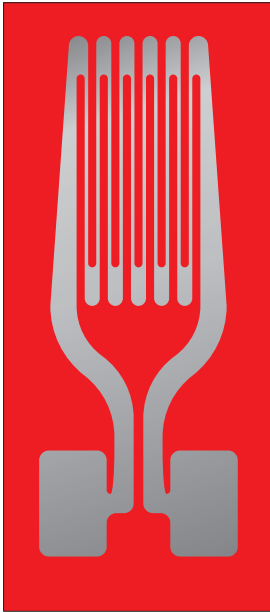

In a conventional strain gauge, the gauge leads, which conduct electrical signal to the metal foil called gauge element, are soldered using leaded solder. The leaded solder is an alloy composed of lead and tin, and the lead is effective to reduce the stress because it is soft. On the other hand, the lead is not only harmful to human bodies but may cause adverse effects on the natural environment. Use of lead-free solder is required according to the RoHS Directive. However, in the combination of lead-free solder and conventional strain gauge pattern, fatigue life conforming to the NAS 942 is not satisfied for some strain gauges. We have developed a new gauge pattern that does not cause stress concentration even if the lead-free solder is used. We propose our next generation strain gauge GOBLET, which maintains the conventional strain gauge performance while considering the environment by the adoption of the new gauge pattern.

The concept of development of GOBLET is "Gauges Of Brilliant Lifespan and Environmentally Thoughtful", which represents the excellent fatigue life and small environmental effect of these strain gauges. The GOBLET is series of our strain gauges which are compliant to RoHS Directive and CE marked.

The GOBLET is currently available for the series below. The dedicated leadwires which use lead-free solder are also available.

- Strain gauge for general use F-series (partly not compliant)
- Strain gauge for high temperature use QF-series (partly not compliant)
- Strain gauge for composite material BF-series
- Strain gauge for plastics GF-series
- Strain gauge for wood and gypsum LF-series
- Strain gauge for post-yield (large strain) measurement YEF-series

## GOBLET Logo (Registered design)



Package of GOBLET series strain gauges (example)

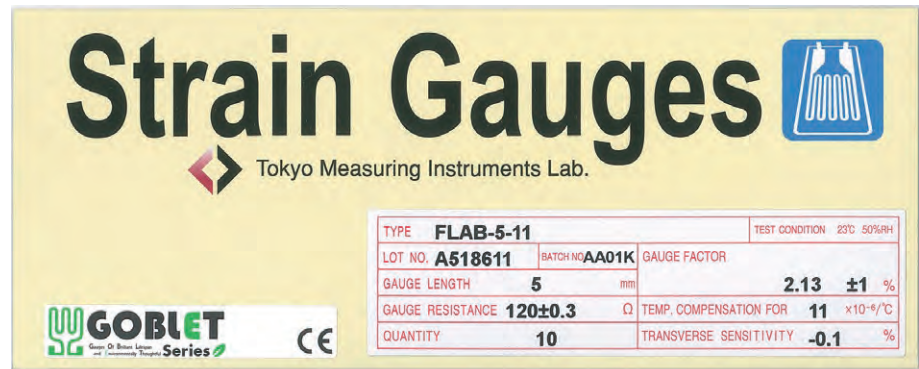

The GOBLET strain gauges bear the logo and the CE mark on their package.

## Dedicated leadwires (using lead-free solder)

Leadwire name	Suffix code	Number of cores/Core diameter(mm)	Cross sectional area (mm <sup>2</sup> )	Operating temperature range (Leadwire only)
Parallel vinyl leadwire	LJB-F	7/0.12	0.08	-20 ~ +80 °C
3-wire parallel vinyl leadwire	LJBT-F	7/0.12	0.08	-20 ~ +80 °C
Parallel vinyl leadwire	LJC-F	10/0.12	0.11	-20 ~ +80 °C
3-wire parallel vinyl leadwire	LJCT-F	10/0.12	0.11	-20 ~ +80 °C
Polypropylene 4-wire parallel leadwire	LQM-F	7/0.12	0.08	-20 ~ +100 °C
3-wire parallel special vinyl leadwire	LXT-F	7/0.12	0.08	-20 ~ +150 °C
3-wire twisted fluorinated resin (FEP) leadwire	6FA □ LT-F	7/0.18	0.18	-269 ~ +200 °C
3-wire twisted fluorinated resin (FEP) leadwire (Surface treatment (tetra-etching) is not required)	6FAS □ LT-F	7/0.18	0.18	-269 ~ +200 °C
3-wire twisted fluorinated resin (FEP) single-core leadwire	6FB □ LT-F	1/0.2	0.03	-269 ~ +200 °C
3-wire twisted fluorinated resin (FEP) leadwire	6FC □ LT-F	7/0.08	0.04	-269 ~ +200 °C
Polyurethane leadwire	LJP-F	1/0.14	0.015	-10 ~ +120 °C
Polyester leadwire	LJU-F	1/0.14	0.015	-196 ~ +200 °C
Polyimide leadwire	LJE-F	1/0.14	0.015	-269 ~ +300 °C



# Foil Strain Gauges F series (GOBLET) CE



Strain gauges compliant to RoHS2 Directive 2011/65/EU are added to the lineup in F series. They are supplied with CE marking as standard specification. Our logo GOBLET, which is an abbreviation of "Gauges Of Brilliant Lifespan and Environmental Thoughtful", is marked on the package of these gauges.

Operating temperature range  
-196~+150°C  
Temperature compensation range  
+10~+100°C

Applicable adhesives  
CN -196~+120°C  
P-2 -30~+150°C  
EB-2 -60~+150°C

Please specify the type number as shown in the example below.

**FLAB -5 (-350) -11 -3LJC-F**

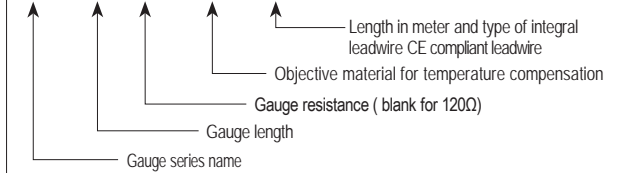

Objective material for temperature compensation (coefficient of linear thermal expansion  $\times 10^{-6}/^{\circ}\text{C}$ )  
-11: Mild steel ■ -17: Stainless steel ■ -23: Aluminium ■

Gauge pattern	Type	Gauge size(mm)		Backing size(mm)		Resistance Ω	
		Length	Width	Length	Width		
<b>●Single axis</b>  General use	FLGB-02	0.2	1.4	3.5	2.5	120	
	FLGB-1	1	1.1	6	2.5	120	
	FLAB-03	0.3	1.4	3	2	120	
	FLAB-05	0.5	1.2	4.3	2.2	120	
	FLAB-1	1	1.3	5	2.5	120	
	FLAB-2	2	1.5	6.5	3	120	
	FLAB-3	3	1.7	7.7	3.5	120	
	FLAB-3-60	3	1.2	7.7	3	60	
	FLAB-5	5	1.5	10	3	120	
	FLAB-6	6	2.2	11	4.3	120	
	FLAB-10	10	2.5	15.4	5	120	
	FLAB-30	30	2	35	5	120	
	FLK pattern with narrow gauge width	FLKB-1	1	0.7	4.5	1.4	120
		FLKB-2	2	0.9	5.5	1.5	120
		FLKB-6	6	1	11	2.2	120
FLKB-10		10	1.6	15	3.8	120	
<b>●350Ω Single axis</b> Gauge resistance 350Ω	FLAB-1-350	1	1.6	4.5	3	350	
	FLAB-1W-350	1	2	4.7	3.6	350	
	FLAB-2-350	2	1.9	6	3.5	350	
	FLAB-3-350	3	1.6	7.2	3	350	
	FLAB-3W-350	3	3.2	8.5	5	350	
	FLAB-5-350	5	1.8	9.4	3.8	350	
Gauge resistance 1000Ω	FLAB-6-1000	6	4.6	11	7	1000	

Minimum order quantity is 10 strain gauges.



# F series (GOBLET)

Gauge pattern	Type	Gauge size(mm)		Backing size(mm)		Resistance Ω
		Length	Width	Length	Width	
<b>● 0° /90° 2-axis Stacked type</b>						
	FCAB-1	1	0.7	φ 4.5		120
	FCAB-2	2	0.9	φ 7		120
	FCAB-3	3	1.7	φ 11		120
	FCAB-5	5	1.9	φ 12		120
	FCAB-6	6	2.4	φ 14		120
	FCAB-10	10	2.5	φ 17		120
	<b>● 350Ω 0° /90° 2-axis Stacked type</b>					
	FCAB-1-350	1	1.6	φ 8		350
	FCAB-2-350	2	1.9	φ 9.5		350
	FCAB-3-350	3	2	φ 10		350
	FCAB-5-350	5	1.8	φ 10		350
<b>● 0° /45° /90° 3-axis Stacked type</b>						
	FRAB-1	1	0.7	φ 4.5		120
	FRAB-2	2	0.9	φ 7		120
	FRAB-3	3	1.7	φ 11		120
	FRAB-5	5	1.9	φ 12		120
	FRAB-6	6	2.4	φ 14		120
	FRAB-10	10	2.5	φ 17		120
	<b>● 350Ω 0° /45° /90° 3-axis Stacked type</b>					
	FRAB-1-350	1	1.6	φ 8		350
	FRAB-2-350	2	1.9	φ 9.5		350
	FRAB-3-350	3	2	φ 10		350
	FRAB-5-350	5	1.8	φ 10		350

Minimum order quantity is 10 strain gauges.

## GLASS, CERAMIC USE

Please specify the type number as shown in the example below.  
-8: Glass, Ceramic 

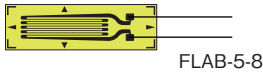
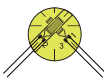
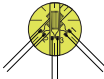
Gauge pattern	Type	Gauge size(mm)		Backing size(mm)		Resistance Ω
		Length	Width	Length	Width	
<b>● Single axis</b>  FLAB-5-8	FLAB-2-8	2	1.5	6.5	3	120
	FLAB-5-8	5	1.5	10	3	120
<b>● 0° / 90° 2-axis Stacked type</b>  FCAB-2-8	FCAB-2-8	2	0.9	φ7		120
	FCAB-5-8	5	1.9	φ12		120
<b>● 0° / 45° / 90° 3-axis Stacked type</b>  FRAB-2-8	FRAB-2-8	2	0.9	φ7		120
	FRAB-5-8	5	1.9	φ12		120

Minimum order quantity is 10 strain gauges.

## Dedicated leadwires recommendable for F series strain gauge(GOBLET)

We supply various leadwires dedicated to strain gauges so as to meet our customers' requirements. Please refer to page 32 to 40 for the details of combination of a strain gauge and a leadwire. For CE marked GOBLET series strain gauges, only the leadwires using lead-free solder are available.

Type and designation of leadwires (GOBLET)

Usage	Leadwire name	Operating temperature range of leadwire (°C)	Type number example
General purpose (without temperature change)	Paralleled vinyl LJB-F	-20 ~ +80	FLAB-5-11-3LJB-F
	Paralleled vinyl LJC-F		FLAB-5-11-3LJC-F
General use	3-wire paralleled vinyl LJBT-F	-20 ~ +80	FLAB-5-11-3LJBT-F
	3-wire paralleled vinyl LJCT-F		FLAB-5-11-3LJCT-F
Mid-high temperature	3-wire paralleled vinyl LXT-F	-20 ~ +150	FLAB-5-11-3LXT-F
1-Gauge 4-Wire measurement	Polypropylene 4-wire paralleled LQM-F	-20 ~ +100	FLAB-5-11-3LQM-F (modular plug attached)

NB: For use with CE compliant GOBLET strain gauges, specify leadwire with option -F having lead-free solder on order.

## Dedicated leadwires recommendable for F series strain gauge

We supply various leadwires dedicated to strain gauges so as to meet our customers' requirements. Please refer to page 32 to 40 for the details of combination of a strain gauge and a leadwire.

Type and designation of leadwires

Usage	Leadwire name	Operating temperature range of leadwire (°C)	Type number example
General purpose (without temperature change)	Paralleled vinyl LJB/LJB-F	-20 ~ +80	FLA-5-11-3LJB
	Paralleled vinyl LJC/LJC-F		FLA-5-11-3LJC
General use	3-wire paralleled vinyl LJBT/LJBT-F	-20 ~ +80	FLA-5-11-3LJBT
	3-wire paralleled vinyl LJCT/LJCT-F		FLA-5-11-3LJCT
Mid-high temperature	3-wire paralleled vinyl LXT/LXT-F	-20 ~ +150	FLA-5-11-3LXT
Temperature integration	3-wire paralleled vinyl TLJBT/TLJBT-F	-20 ~ +80	FLA-5-T-11-3TLJBT
1-Gauge 4-Wire measurement	Polypropylene 4-wire paralleled LQM/LQM-F	-20 ~ +100	FLA-5-11-3LQM (modular plug attached)



# F series

In the F series, strain gauges dedicated to a special usage (shearing strain measurement, torque measurement, residual stress measurement or stress concentration measurement) and 2-axis plane type strain gauges are compliant to RoHS Directive when they are supplied with Option-F.

Operating temperature range	-196~+150°C	Applicable adhesives	CN -196~+120°C
Temperature compensation range	+10~+100°C	P-2	-30~+150°C
		EB-2	-60~+150°C

Please specify the type number as shown in the example below.

**FLT-05A (-350) -11 (-F) -3LJC (-F)**

↑ Gauge series name  
 ↑ Gauge resistance (blank for 120Ω)  
 ↑ Objective material for temperature compensation  
 ↑ Option F: LEAD-free soldering of strain gauge  
 ↑ Length in meter and type of integral leadwire  
 ↑ Option F: LEAD-free soldering of leadwire

Objective material for temperature compensation (coefficient of linear thermal expansion  $\times 10^{-6}/^{\circ}\text{C}$ )  
 -11: Mild steel ■ -17: Stainless steel ■ -23: Aluminium ■

## Shearing • Torque • Plane

Gauge pattern	Type	Gauge size(mm)		Backing size(mm)		Resistance Ω
		Length	Width	Length	Width	
<b>● Shearing strain measurement</b> 	FLT-05A	0.55	0.66	4	1.3	120
	FLT-05B	0.55	0.66	4	1.3	120
<b>● Torque measurement</b> 	FCT-2	2	1.5	8.7	6.5	120
	FCT-2-350	2	1.5	7.6	5.3	350
<b>● 0° / 90° 2-axis Plane type</b> 	FCB-2	2	1.5	X / Y axis 8.2   8		120
	FCB-6-350	6	2	X / Y axis 10   11.9		350

Minimum order quantity is 10 strain gauges.











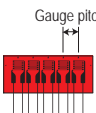

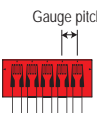
## Residual stress measurement

Gauge pattern	Type	Gauge size(mm)		Backing size(mm)		Resistance Ω
		Length	Width	Length	Width	
<b>● Residual stress measurement</b> 	FR-5	5	1.5	Φ12		120
	EUBC-06	0.6	0.7	Φ2.4		120
<b>● Residual stress measurement using hole drilling method</b> 	FRAS-2	2	1.1	9	9	120
	FRS-2	1.5	1.3	Φ9.5		120
	FRS-3	3	2.6	Φ17.5		120

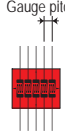
Gauge center diameter

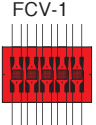
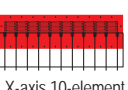
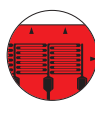
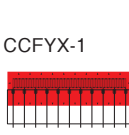
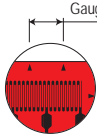
Minimum order quantity is 10 strain gauges.

## Stress Concentration Measurement

Gauge pattern		Type	Gauge size(mm)		Backing size(mm)		Resistance $\Omega$		
			Length	Width	Length	Width			
<b>●5-element Single-axis</b>									
FXV-1-11-002LE	FYV-1-11-002LE								
									
		Gauge pitch 2mm	FXV-1-11-002LE	1	1.3	5	12	120	
			FYV-1-11-002LE	1	1.4	5	12	120	
-002LE: Polyimide insulated gauge lead of 2-cm pre-attached									
FBXV-04	FBYV-06								
									
		Gauge pitch 1mm	FBXV-04-11-005LE	0.4	1.3	5.4	7.4	120	
			FBYV-06-11-005LE	0.6	0.8	5.3	7	120	
-005LE: Polyimide insulated gauge lead of 5-cm pre-attached									
<b>●10-element 2-axes</b>									
FCV-1		X and Y axes Y-axis leadwire is marked for identification.							
			Gauge pitch 2mm	FCV-1-11-005LE	1	1.4	7.5	12	120
-005LE: Polyimide insulated gauge lead of 5-cm pre-attached									
<b>●Chain Strain Gauges</b>									
CCFXX-1	CCFYX-1								
									
X-axis 10-element		Y-axis 10-element	Gauge pitch 1.5mm	CCFXX-1-11-002LE	1	1.5	4.5	16.4	120
				CCFYX-1-11-002LE	1	1.5	4.5	16.4	120
-002LE: Polyimide insulated gauge lead of 2-cm pre-attached									
These gauges are specially designed to use Complete Compensation Method of Strain and need our Data Logger TDS-540 for the measurement. For details, contact TML.									
<b>●Single axis</b>									
Single element cut away from the above Stress Concentration gauge									
FBX-04		Q (x 3)							
FBY-06		Q (x 3)							
FLX-1		Q (x 3)							
				FBX-04-11-005LE	0.4	1.3	5.4	1	120
				FBY-06-11-005LE	0.6	0.8	5.3	1	120
				FLX-1-11-002LE	1	1.3	5	2	120
-005LE: Polyimide insulated gauge lead of 5-cm pre-attached -002LE: Polyimide insulated gauge lead of 2-cm pre-attached									

Minimum order quantity is 10 strain gauges.



### Important point

#### Option F

This code is appended to the basic strain gauge type for strain gauges with lead-free solder in place of leaded solder. Fatigue life of the strain gauge may become shorter by the use of the lead-free solder.



### Note

These gauges are specially designed to use Complete Compensation Method of Strain and need our Data Logger TDS-540 for the measurement. For details, contact TML.



# Waterproof Strain Gauges WF series CE

These gauges eliminate the need for moisture-proofing coating, which is sometimes troublesome in a field test. They have an integral vinyl leadwire, and whole area of the strain gauges and the leadwire junction are coated with epoxy resin. The coating is transparent and flexible, so the positioning and bonding works are very easy. By merely bonding the gauges with CN or P-2 adhesive, outdoor or underwater measurement for a short-term becomes possible. These gauges are also effective in omitting primary coating in case of applying a multi-layer coating.

Operating temperature range	0~+80°C	Applicable adhesives	CN	0~+80°C
Temperature compensation range	+10~+80°C	P-2	0~+80°C	
		EB-2	0~+80°C	

### Example of type number designation

**WFLA -3 -350 -11 -3LDBB**

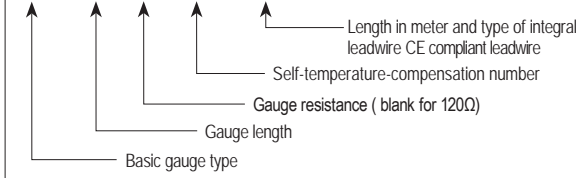

### Suffix code for temperature compensation materials

-11: Mild steel (red) -17: Stainless steel (orange) -23: Aluminium (green)

For ordering, the above suffix code should be added to the basic gauge type

Gauge pattern	Type	Gauge size(mm)		Backing size(mm)			Resistance Ω		
		Length	Width	Length	Width	Thickness			
<b>● Single axis</b> 0.08mm <sup>2</sup> integral vinyl leadwire Total leadwire resistance per meter : 0.44 Ω 2-wire system  WFLA-3-11-1LDBB WFLA-3-350-11-1LDBB  <b>● 0° /45° /90° 3-axis Stacked type</b> 2-wire system  WFRA-3-11-1LDBB	Single element	WFLA-3	3	1.7	17	8	1.5	120	
		WFLA-3-350	3	3.2	17	8	1.5	350	
		WFLA-6	6	2.2	25	11	1.5	120	
	2-wire system	2-element Rosette 0°/90°	WFCA-3	3	1.7	19	16	1.5	120
		WFCA-6	6	2.3	25	21	1.5	120	
		3-element Rosette 0°/45°/90°	WFRA-3	3	1.7	19	16	1.5	120
		WFRA-6	6	2.3	25	21	1.5	120	
<b>● Single axis</b> 3-wire system  WFLA-6-11-3LDBTB <b>● 0° /90° 2-element stacked Rosette</b> 3-wire system  WFCA-6-11-3LDBTB <b>● 0° /45° /90° 3-axis Stacked type</b> 3-wire system  WFRA-6-11-3LDBTB	Single element	WFLA-3	3	1.7	17	8	1.5	120	
		WFLA-6	6	2.2	25	11	1.5	120	
	2-wire system	2-element Rosette 0°/90°	WFCA-3	3	1.7	19	16	1.5	120
		WFCA-6	6	2.3	25	21	1.5	120	
	3-wire system	3-element Rosette 0°/45°/90°	WFRA-3	3	1.7	19	16	1.5	120
		WFRA-6	6	2.3	25	21	1.5	120	

Minimum order quantity is 10 strain gauges.





# High Temperature Strain Gauges QF series

These are CE marked strain gauges (compliant to RoHS2 Directive) for high temperature use. They have joined to our well proven QF-series strain gauges with a new series name "GOBLET". These are foil strain gauges utilizing polyimide resin as the backing material. Measurement in high temperature is easily possible by using our room-temperature-curing adhesive NP-50B for bonding.

Operating temperature range  
-30~+200°C  
Temperature compensation range  
+10~+100°C



Applicable adhesives  
NP-50B -30~+200°C  
C-1/EB-2 -30~+200°C  
CN -30~+120°C

Please specify the type number as shown in the example below.

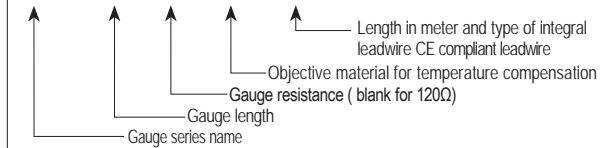
**QFLAB -6 (-350) -11 -3LJC-F**

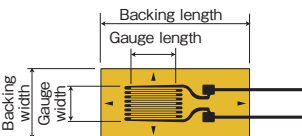
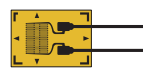

Objective material for temperature compensation  
(coefficient of linear thermal expansion  $\times 10^{-6}/^{\circ}\text{C}$ )  
-11: Mild steel -17:Stainless steel -23:Aluminium -28:Magnesium   
Note: The backing color of QF series gauges are the same for every material for temperature compensation.

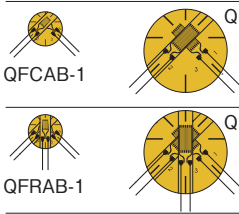
Gauge pattern	Type	Gauge size(mm)		Backing size(mm)		Resistance $\Omega$
		Length	Width	Length	Width	
 <b>● Single axis</b>  QFLGB-02  Q(x 3)  QFLAB-1  Q(x 3)	General purpose					
	QFLGB-02	0.2	1.4	3.5	2.5	120
	QFLAB-03	0.3	1.4	3	2	120
	QFLAB-1	1	1.1	4.7	2	120
	QFLAB-2	2	1.5	6.5	3	120
	QFLAB-3	3	1.7	7.7	3.5	120
	QFLAB-5	5	1.5	10	3	120
	QFLAB-6	6	2.2	11	4.3	120
	QFLAB-30	30	2	35	5	120
	FLK type with narrow backing					
for magnesium alloy						
gauge resistance 350 $\Omega$	QFLKB-1	1	0.7	4.5	1.4	120
	QFLKB-2	2	0.9	5.5	1.5	120
	QFLKB-2-28	2	0.9	5.5	1.5	120
	QFLAB-1-350	1	1.6	4.5	3	350
	QFLAB-1W-350	1	2	4.7	3.6	350
	QFLAB-2-350	2	1.9	6	3.5	350
High gauge resistance 1000 $\Omega$	QFLAB-3-350	3	1.6	7.2	3	350
	QFLAB-3W-350	3	3.2	8.5	5	350
	QFLAB-6-350	6	2.6	10.8	4.5	350
	QFLAB-6-1000	6	4.6	11	7	1000
 <b>● 0° /90° 2-axis Stacked type</b>  <b>● 0° /45° /90° 3-axis Stacked type</b>	QFCAB-1	1	0.7	$\phi 4.5$		120
	QFCAB-3	3	1.7	$\phi 11$		120
	QFRAB-1	1	0.7	$\phi 4.5$		120
	QFRAB-3	3	1.7	$\phi 11$		120

Minimum order quantity is 10 strain gauges.

## Dedicated leadwire recommended for QF series strain gauges (GOBLET) (made to order)

We supply various leadwires dedicated to strain gauges so as to meet our customers' requirements. Please refer to page 32 to 40 for the details of combination of a strain gauge and a leadwire. For CE marked GOBLET series strain gauges, only the leadwires using lead-free solder are available.

### Type and designation of leadwires

Usage	Leadwire name	Operating temperature range of leadwire (°C)	Type number example
General purpose (without temperature change)	Parallel vinyl leadwire LJC-F	-20 ~ +80	QFLAB-1-11-3LJC-F
General purpose	3-wire parallel vinyl leadwire LJCT-F	-20 ~ +80	QFLAB-1-11-3LJCT-F
High temperature	3-wire twisted FEP leadwire 6FA □ LT-F	-269 ~ +200	QFLAB-1-11-6FA3LT-F
	3-wire twisted FEP single-core leadwire 6FB □ LT-F		QFLAB-1-11-6FB3LT-F

NB: □ shows the lead wire length in meter



# High Temperature Strain Gauges QF series

These are foil strain gauges having a polyimide resin backing, which exhibits excellent performance in high temperature up to 200°C. Stress concentration measurement gauges and shear stress measurement gauges are also available in this series. Integral leadwires using lead-free solder are available with option -F.

Operating temperature range	-20~+200°C	Applicable adhesives	
Temperature compensation range	+10~+100°C	NP-50B	-20~+200°C
		C-1/EB-2	-20~+200°C
		CN	-20~+120°C

Please specify the type number as shown in the example below.

**QFCT -2 (-350) -11 (-F) -3LJC (-F)**

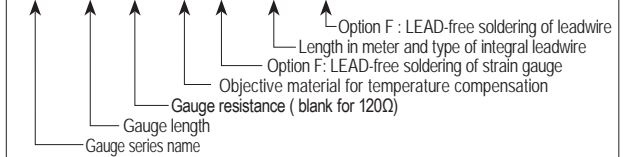

Objective material for temperature compensation

(coefficient of linear thermal expansion  $\times 10^{-6}/^{\circ}\text{C}$ )

-11: Mild steel -17:Stainless steel -23:Aluminium -28:Magnesium

Note: The backing color of QF series gauges are the same for every material for temperature compensation.

## Shearing • Torque • Plane

Gauge pattern	Type	Gauge size(mm)		Backing size(mm)		Resistance $\Omega$
		Length	Width	Length	Width	
<b>● Shearing strain measurement</b>						
	QFLT-05A-11-002LE	0.55	0.66	4	1.3	120
	QFLT-05B-11-002LE	0.55	0.66	4	1.3	120
	QFLT-1A-11-002LE	1.2	1.1	5.7	2	120
	QFLT-1-350A-11-002LE	1.2	1.1	5.7	2	350
	QFLT-1B-11-002LE	1.2	1.1	5.7	2	120
	QFLT-1-350B-11-002LE	1.2	1.1	5.7	2	350
-002LE: Polyimide insulated gauge lead of 2-cm pre-attached						
	QFCT-2	2	1.5	8.7	6.5	120
	QFCT-2-350	2	1.5	7.6	5.3	350
<b>● Torque measurement</b>						
	QFCB-2	2	1.5	X / Y axis 8.2   8		120
<b>● 0° /90° 2-axis Plane type</b>						
Minimum order quantity is 10 strain gauges.						

## Stress Concentration Measurement

Gauge pattern	Type	Gauge size(mm)		Backing size(mm)		Resistance $\Omega$
		Length	Width	Length	Width	
<b>● 5-element Single-axis</b>						
	Gauge pitch 2mm	1	1.3	5	12	120
-002LE: Polyimide insulated gauge lead of 2-cm pre-attached						
	Gauge pitch 1mm	0.4	1.3	5.4	7.4	120
-005LE: Polyimide insulated gauge lead of 5-cm pre-attached						
<b>● Single axis</b>						
Single element cut away from the above Stress Concentration gauge						
	Single axis	0.4	1.3	5.4	1	120
-005LE: Polyimide insulated gauge lead of 5-cm pre-attached						
-002LE: Polyimide insulated gauge lead of 2-cm pre-attached						
Minimum order quantity is 10 strain gauges.						



# High Temperature Strain Gauges ZF series

These strain gauges are designed for measurement in high temperature up to 300°C. It utilizes specially designed Ni-Cr alloy foil for the grid and polyimide resin for the gauge backing. Owing to the construction, the strain gauges are successfully used for measurement in high temperature.

Operating temperature range  
-20~+300°C  
Temperature compensation range  
+10~+100°C

Applicable adhesives  
NP-50B -20~+300°C  
C-1/EB-2 -20~+200°C  
CN -20~+120°C

Please specify the type number as shown in the example below.

**ZFLA -6 (-350) -11 -6FA3LT-F**

↑ Gauge series name  
↑ Gauge length  
↑ Gauge resistance (blank for 120Ω)  
↑ Objective material for temperature compensation  
↑ Length in meter and type of integral leadwire CE compliant leadwire

Objective material for temperature compensation (coefficient of linear thermal expansion  $\times 10^{-6}/^{\circ}\text{C}$ )  
-11: Mild steel -17:Stainless steel -23:Aluminium

Note: The backing color of ZF series gauges are the same for every material for temperature compensation.

Gauge pattern	Type	Gauge size(mm)		Backing size(mm)		Resistance Ω
		Length	Width	Length	Width	
<p>● Single axis</p>	ZFLK-2	2	0.5	5.4	1.4	120
<p>● 0°/90° 2-axis Plane type</p>	ZFLA-1	1	1.8	7	3	120
	ZFLA-3	3	1.8	10.5	3.5	120
	ZFLA-6	6	2.5	15.5	4.5	120
	ZFLA-3-60	3	0.7	7.7	2.6	60
	ZFLA-1-350	1	1.7	6.6	3.2	350
	ZFLA-3-350	3	3.1	10.2	5.2	350
	ZFLA-6-350	6	2.8	16	5.3	350
<p>● 0°/45°/90° 3-axis Plane type</p>	ZFCA-1-350	1	1.7	8.5	8.5	350
	ZFCA-3-350	3	1.4	10.5	10.5	350
<p>● 0°/45°/90° 3-axis Plane type</p>	ZFCAL-1	1	1.1	Φ5.4		120
	ZFRA-1-350	1	1.7	8.5	8.5	350
	ZFRA-3-350	3	1.4	10.5	10.5	350
<p>● 0°/45°/90° 3-axis Plane type</p>	ZFRAL-1	1	1.1	Φ5.4		120

Minimum order quantity is 10 strain gauges.

## Dedicated leadwire recommended for ZF series strain gauges

We supply various leadwires dedicated to strain gauges so as to meet our customers' requirements. Please refer to page 32 to 40 for the details of combination of a strain gauge and a leadwire. For CE marked strain gauges, only the leadwires using lead-free solder are available.

### Type and designation of leadwires

Usage	Leadwire name	Operating temperature range of leadwire (°C)	Type number example
High temperature	3-wire twisted fluorinated resin (FEP) leadwire 6FA □ LT-F	-269 ~ +200	ZFLA-3-350-11-6FA3LT-F
	3-wire twisted fluorinated resin (FEP) single-core leadwire 6FB □ LT-F		ZFLA-3-350-11-6FB3LT-F
	3-wire twisted fluorinated resin (PTFE) leadwire 4FA □ LT-F	-269 ~ +260 For short term use, +300°C is available.	ZFLA-3-350-11-4FA3LT-F
	3-wire twisted fluorinated resin (PTFE) single-core leadwire 4FB □ LT-F		ZFLA-3-350-11-4FB3LT-F

NB: □ shows the lead wire length in meter



# High Temperature Strain Gauges EF series

These gauges have a small grid pattern required for measurement of printed circuit boards and surface mounted devices, which are getting smaller and smaller. The backing of the gauges is made of polyimide resin. The maximum operating temperature is +300°C for single element gauges and +200°C for two and three elements gauges. The lowest operating temperature is -196°C for both gauges.

### Operating temperature range

For more information, please see below.

### Temperature compensation range

For more information, please see below.

### Applicable adhesives

CN	-196~+120°C
EB-2	-60~+200°C
C-1	-196~+200°C
NP-50B	-30~+300°C

Please specify the type number as shown in the example below.

**EFLK -02 -11 -4FA3LT-F**

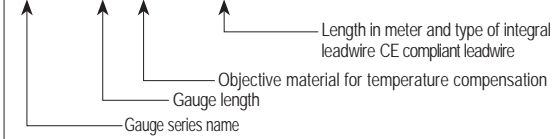

Objective material for temperature compensation (coefficient of linear thermal expansion  $\times 10^{-6}/^{\circ}\text{C}$ )

-11: Mild steel ■

Gauge pattern	Type	Gauge size(mm)		Backing size(mm)		Resist- ance $\Omega$	
		Length	Width	Length	Width		
 EFLX-02-11 <b>● Single axis</b> Operating temperature range -196~+300°C Temperature compensation range +10~+150°C 	EFLK-02-11	0.2	0.8	1.6	1.2	120	
	EFLX-02-11	0.2	0.8	1.8	1.2	120	
<b>● 0° /90° 2-axis Stacked</b> Operating temperature range -196~+200°C Temperature compensation range 0~+150°C <b>● 0° /45° /90° 3-axis Stacked</b> Operating temperature range -196~+200°C Temperature compensation range 0~+150°C 	EFCA-05-11-002LE	0.5	0.4	$\phi$ 3.8		120	
	-002LE: Polyimide insulated gauge lead of 2-cm pre-attached						
	EFRA-05-11-002LE	0.5	0.4	$\phi$ 3.8		120	
	-002LE: Polyimide insulated gauge lead of 2-cm pre-attached						

Minimum order quantity is 10 strain gauges.



# High & Low Temperature Strain Gauges CEF series C E

These are strain gauges utilizing polyimide resin for the gauge backing and special alloy foil for the grid. It features a wide range of operating temperature from cryogenic temperature to +200°C. This series is available only in single axis configuration with gauge length of 1,3 and 6mm.

Please specify the type number as shown in the example below.

**CEFLA -6 -11 -6FA3LT-F**

↑ Gauge series name    ↑ Gauge length    ↑ Objective material for temperature compensation    ↑ Length in meter and type of integral leadwire CE compliant leadwire

Objective material for temperature compensation (coefficient of linear thermal expansion  $\times 10^{-6}/^{\circ}\text{C}$ )  
 -11: Mild steel -17:Stainless steel -23:Aluminium

Note: The backing color of CEF series gauges are the same for every material for temperature compensation.

Operating temperature range -269~+200°C	Applicable adhesives
Temperature compensation range (approx.)-196~+80°C	EA-2A    -269~+50°C
	CN        -196~+120°C
	C-1       -269~+200°C
	EB-2     -60~+200°C

Gauge pattern	Type	Gauge size(mm)		Backing size(mm)		Resistance Ω
		Length	Width	Length	Width	
<p>Single axis</p> <p>CEFLA-1 (x3)</p>						
	CEFLA-1	1	0.5	4	2.2	120
	CEFLA-3	3	0.6	6.9	2.8	120
	CEFLA-6	6	1	10.6	3.1	120

Minimum order quantity is 10 strain gauges.

## Dedicated leadwire recommended for CEF series strain gauges (made to order)

We supply various leadwires dedicated to strain gauges so as to meet our customers' requirements. Please refer to page 32 to 40 for the details of combination of a strain gauge and a leadwire. For CE marked strain gauges, only the leadwires using lead-free solder are available.

### Type and designation of leadwires

Usage	Leadwire name	Operating temperature range of leadwire (°C)	Type number example
High & Low temperature	3-wire twisted FEP leadwire 6FA □ LT-F	-269 ~ +200	CEFLA-1-11-6FA3LT-F
	3-wire twisted FEP single-core leadwire 6FB □ LT-F		CEFLA-1-11-6FB3LT-F
	3-wire twisted fluorinated resin (PTFE) leadwire 4FA □ LT-F	-269 ~ +260	CEFLA-1-11-4FA3LT-F
	3-wire twisted fluorinated resin (PTFE) single-core leadwire 4FB □ LT-F		CEFLA-1-11-4FB3LT-F

NB: □ shows the lead wire length in meter



# Cryogenic Temperature Strain Gauges CF series CE

These are foil strain gauges with epoxy backing designed for measurement under cryogenic conditions. They are available in single element, rectangular 2-element and rectangular 3-element configurations with 350Ω resistance. The specially selected and heat treated grid of the gauges shows very small zero shift under cryogenic temperature compared to conventional strain gauges.

Operating temperature range -269 ~ +80°C	Applicable adhesives EA-2A -269 ~ +50°C CN -196 ~ +80°C C-1 -269 ~ +80°C
Temperature compensation range (approx.) -196 ~ +80°C	

Please specify the type number as shown in the example below.

**CFLA -6 -350 -11 -6FA3LT-F**

Objective material for temperature compensation (coefficient of linear thermal expansion  $\times 10^{-6}/^{\circ}\text{C}$ )  
 .11: Mild steel ■ .17: Stainless steel ■ .23: Aluminium ■

Gauge pattern	Type	Gauge size(mm)		Backing size(mm)		Resistance Ω
		Length	Width	Length	Width	
<p>● Single axis</p> <p>CFLA-1-350</p> <p>CFLA-6-350</p>	CFLA-1-350	1	1.6	5.4	3.2	350
	CFLA-3-350	3	1.7	8.8	3.5	350
	CFLA-6-350	6	2.2	12.5	4.3	350
<p>● 0° /90° 2-axis Plane type</p> <p>CFCA-1-350</p>	CFCA-1-350	1	1.3	7.2	7.2	350
	CFCA-3-350	3	1.7	11	11	350
<p>● 0° /45° /90° 3-axis Plane type</p> <p>CFRA-1-350</p>	CFRA-1-350	1	1.3	7.2	7.2	350
	CFRA-3-350	3	1.7	11	11	350

Minimum order quantity is 10 strain gauges.

## Dedicated leadwire recommended for CF series strain gauges (made to order)

We supply various leadwires dedicated to strain gauges so as to meet our customers' requirements. Please refer to page 32 to 40 for the details of combination of a strain gauge and a leadwire. For CE marked strain gauges, only the leadwires using lead-free solder are available.

### Type and designation of leadwires

Usage	Leadwire name	Operating temperature range of leadwire (°C)	Type number example
Cryogenic	3-wire twisted FEP leadwire 6FA □ LT-F	-269 ~ +200	CFLA-1-350-11-6FA3LT-F
	3-wire twisted FEP single-core leadwire 6FB □ LT-F		CFLA-1-350-11-6FB3LT-F
	3-wire twisted fluorinated resin (PTFE) leadwire 4FA □ LT-F 3-wire twisted fluorinated resin (PTFE) single-core leadwire 4FB □ LT-F	-269 ~ +260	CFLA-1-350-11-4FA3LT-F CFLA-1-350-11-4FB3LT-F





NB: □ shows the lead wire length in meter



# Weldable Strain Gauges **AW** series (AWM · AWMD · AWH · AWHU · AW · AWC)

These strain gauges have strain sensing elements fully encapsulated in corrosion-resisting metal tubes made of stainless steel or Inconel (except AW-6-350). The strain gauge backings are also made of the same material, and the gauges are installed by spot welding to metal specimens using a dedicated spot welder.

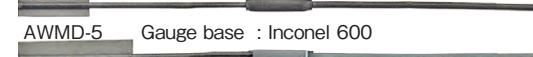
## Type

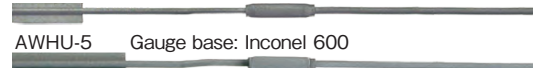
<p><b>AWM</b>    -196~+300° C    Quarter bridge 3-wire</p>  <p><b>CE</b>    AWM-8-1A Gauge base : Inconel 600 AWM-8-1B Gauge base : SUS304</p>	<p><b>AW-6</b>    -196~+300° C    Quarter bridge 3-wire</p>  <p><b>CE</b>    AW-6-350-11-4FB01LT</p>
<p><b>AWMD</b>    -196~+800° C for dynamic strain    Full bridge</p>  <p><b>CE</b>    AWMD-5 Gauge base : Inconel 600 AWMD-8 Gauge base : Inconel 600</p>	<p><b>AWC</b>    -20~+100° C    Quarter bridge 3-wire</p>  <p>AWC-8B-11-3LTSB</p>
<p><b>AWH</b>    -196~+600° C for static strain    Full bridge -196~+650° C for dynamic strain</p>  <p><b>CE</b>    AWH-4-7A/AWH-8-7A Gauge base: Inconel 600 AWH-4-7B/AWH-8-7B Gauge base: SUS304</p>	<p><b>AWHU</b>    -196~+800° C    Full bridge</p>  <p><b>CE</b>    AWHU-5 Gauge base: Inconel 600 AWHU-8 Gauge base: Inconel 600</p>

## AW series coding system

①	②	③	④	⑤	⑥	⑦	⑧	
AWM	-8	-1	B		-2		-17.0	
AWMD	-5	-	A	KM	-2	(6F)	-1.6Hz*	*: High-pass filter only for AWMD Either one available among 1.6, 7.2 or 16Hz.
AWMD	-8	-	A		-2		-1.6Hz*	
AWH	-8	-7	A		-2		-11.0	
AWHU	-5	-9	A	KM	-2	(6F)	-12.7	

① Type	② Gauge length	③ Temperature compensation range	④ Gauge base*1	⑤ Option
AWM : static/dynamic 300°C	8 : 8mm	0 : -196°C~ RT 1 : RT ~+300°C	A : Inconel 600 Applicable thermal expansion coefficient of 11ppm/°C or closer B : SUS304 Applicable thermal expansion coefficient of 17ppm/°C or closer	E: Ground earth F: Compression fittings K: Narrow gauge width W=3mm (excluding AWHU) M: Small junction type of sleeve B Φ 2.0mm L=20mm AWHU and AWMD-5 are normally provided with small junction P: NDIS type plug attached*2 R: Bend of gauge backing or pipe Z: Filter-less (AWMD)
AWMD : dynamic only 800°C	5 : 5mm 8 : 8mm	2 : RT ~+350°C 3 : RT ~+400°C 4 : RT ~+450°C		
AWH : static 600°C dynamic 650°C	4 : 4mm 8 : 8mm	5 : RT ~+500°C 6 : RT ~+550°C 7 : RT ~+600°C 8 : RT ~+650°C 9 : RT ~+800°C 10 : Others		
AWHU : static/dynamic 800°C	5 : 5mm 8 : 8mm	NB1: Dynamic use AWMD is not applicable. NB2: RT Room temperature		

⑥ MI cable	⑦ Supplied cable length	⑧ Temperature compensation materials or High-pass filter
2 : Φ1.6mm 2m Core cable of heat-resistive copper	No marks: Φ 4.1mm shielded vinyl cable of 0.5m Except for standard length, required length is given in bracket Example: 4.5m long to (4.5) (6F): Φ 1.6mm shielded fluoroethylene propylene cable (FEP) of 0.5m for AWHU-5/-8, AWMD-5 Except for standard length, required length is given after suffix 6F. Example: 4.5m long to (6F4.5)	Materials available for temperature-compensation 10.9: SUS430 or equivalent 11.0: Mild steel (ferritic) or equivalent 12.7: INCONEL 600 or equivalent 17.0: SUS304 or equivalent High-pass filter for only AWMD 1.6Hz    7.2Hz    16Hz

\*1: Select code A for thermal expansion coefficient of 11ppm/°C or closer, or B for coefficient of 17ppm/°C

\*2: For option code P, NDIS plug is attached to the end of cables following Temperature-compensation board or High-pass filter.



# AW series (AWM/AWMD)

## AWM-8

The AWM is usable up to 300° C for both static and dynamic strain measurement. The backing material is available in Inconel 600 or SUS304 which should be selected according to the test specimen material.

Type	Gauge length (mm)	Gauge base		Operating temperature (°C)	Temperature compensation range (°C)	Test specimen	Applicable coefficient of linear thermal expansion ( $\times 10^{-6}/^{\circ}\text{C}$ )	Resistance in ( $\Omega$ )
		Dimension (mm)	Materials					
AWM-8-1A-2-11.0	8	L16xW5xT0.7	Inconel 600	For static/dynamic use -196~+300°C	Room-temperature ~ +300°C	Mild steel equivalent	11 $\times 10^{-6}/^{\circ}\text{C}$	120
AWM-8-1B-2-17.0			SUS304			SUS304 equivalent		

Leadwire 1.6 mm dia. MI cable 2 m, 4.1 mm dia. shielded vinyl cable 0.5 m (Quarter bridge with 3-wire)  
Minimum order quantity is 1 strain gauge.

### External dimensions

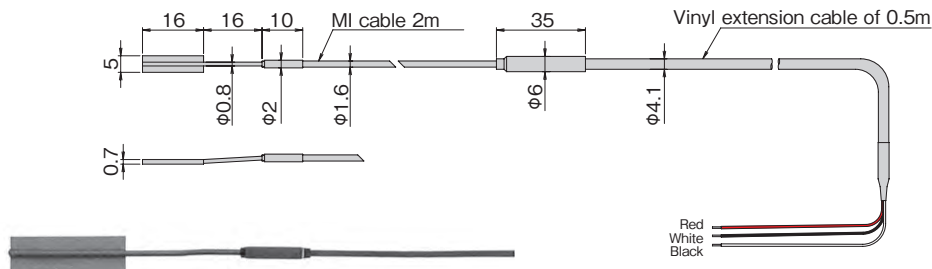

## AWMD-5 / AWMD-8

The AWMD is applicable up to 800° C and it is dedicated to dynamic strain measurement. A high pass filter is a standard accessory. Using the high pass filter, unnecessary direct current component or low frequency component (thermal output, drift etc.) in the measurement signals can be neglected.

Type	Gauge length (mm)	Gauge base		Operating temperature (°C)	Temperature compensation range (°C)	Test specimen	Applicable coefficient of linear thermal expansion ( $\times 10^{-6}/^{\circ}\text{C}$ )	Resistance in ( $\Omega$ )
		Dimension (mm)	Materials					
AWMD-5-AKM-2(6F)-1.6Hz**	5	L10xW3xT0.7	Inconel 600	for dynamic use -196~+800°C	N/A	Inconel 600 equivalent	12 $\times 10^{-6}/^{\circ}\text{C}$	60
AWMD-8-A-2-1.6Hz**	8	L16xW5xT0.7	Inconel 600					120

\*: High-pass filter only for AWMD Either one available among 1.6, 7.2 or 16Hz.

Leadwire AWMD-5 : 1.6 mm dia. MI cable 2 m, 1.6 mm dia. shielded fluorinated resin (FEP) cable 0.5 m (Full bridge)

AWMD-8 : 1.6 mm dia. MI cable 2 m, 4.1 mm dia. shielded vinyl cable 0.5 m (Full bridge)

Minimum order quantity is 1 strain gauge.

### External dimensions

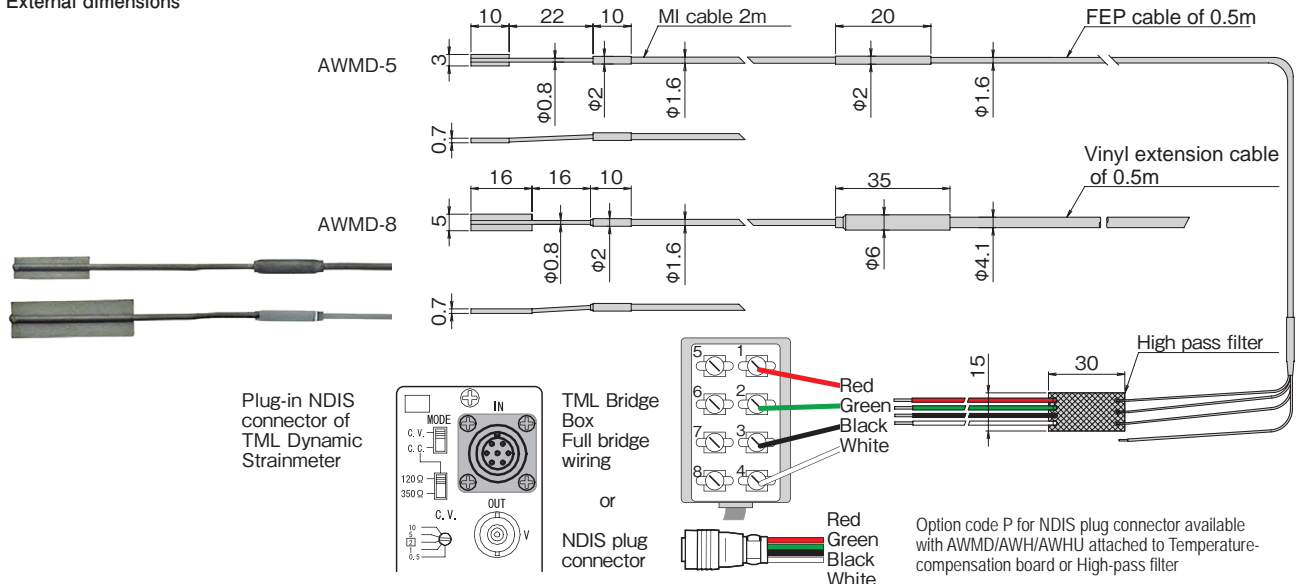

Plug-in NDIS connector of TML Dynamic Strainmeter

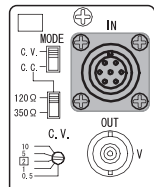

TML Bridge Box Full bridge wiring or NDIS plug connector

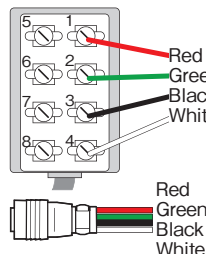

Option code P for NDIS plug connector available with AWMD/AWH/AWHU attached to Temperature-compensation board or High-pass filter





# AW series (AWH/AWHU)

## AWH-4 / AWH-8

The backing material of these gauges is available in either of Inconel 600 or stainless steel to be selected according to the material to be measured. The sensing part has half bridge configuration with active element and dummy element, and it is measured in full bridge method using the attached temperature compensation circuit board. This gauge is applicable to static measurement in temperature up to 600°C and applicable to dynamic measurement up to 650°C.

Type	Gauge length (mm)	Gauge base		Operating temperature (°C)	Temperature compensation range (°C)	Test specimen	Applicable coefficient of linear thermal expansion ( $\times 10^{-6}/^{\circ}\text{C}$ )	Resistance in ( $\Omega$ )
		Dimension (mm)	Materials					
AWH-4-7A-2-11.0	4	L10xW3xT0.8	Inconel 600	static : -196~+600°C dynamic : -196~+650°C	static : RT~+600°C dynamic : N/A	Mild steel equivalent	$11 \times 10^{-6}/^{\circ}\text{C}$	60
AWH-4-7B-2-17.0			SUS304			SUS304 equivalent	$17 \times 10^{-6}/^{\circ}\text{C}$	
AWH-8-7A-2-11.0	8	L16xW5xT0.8	Inconel 600			Mild steel equivalent	$11 \times 10^{-6}/^{\circ}\text{C}$	
AWH-8-7B-2-17.0			SUS304			SUS304 equivalent	$17 \times 10^{-6}/^{\circ}\text{C}$	

Leadwire 1.6 mm dia. MI cable 2 m, 4.1 mm dia. shielded vinyl cable 0.5 m (Full bridge)  
Minimum order quantity is 1 strain gauge.

### External dimensions

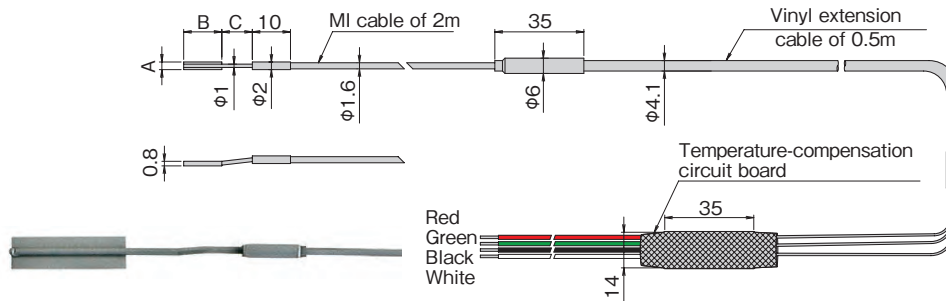

Type	A	B	C
AWH-4	3	10	8
AWH-8	5	16	16

## AWHU-5 / AWHU-8

These gauges can be used in temperature up to 800°C for both static and dynamic measurement. However, owing to the construction of the sensing element, measurement is recommended in temperature at 600°C or above. The sensing part has half bridge configuration with active element and dummy element, and it is measured in full bridge method using the attached temperature compensation circuit board. Since these gauges have small backings and thin sleeves and cables as standard specifications, they are applicable to narrow and/or curved areas.

Type	Gauge length (mm)	Gauge base		Operating temperature (°C)	Temperature compensation range (°C)	Test specimen	Applicable coefficient of linear thermal expansion ( $\times 10^{-6}/^{\circ}\text{C}$ )	Resistance in ( $\Omega$ )
		Dimension (mm)	Materials					
AWHU-5-9AKM-2(6F)-12.7	5	L10xW3xT0.8	Inconel 600	For static/dynamic use -196~+800°C	Room-temperature ~ +800°C	Inconel 600 equivalent	$11 \times 10^{-6}/^{\circ}\text{C}$	60
AWHU-8-9AKM-2(6F)-12.7	8	L16xW3xT0.8						120

Leadwire 1.6 mm dia. MI cable 2 m, 1.6 mm dia. shielded fluorinated resin (FEP) cable 0.5 m (Full bridge)  
Minimum order quantity is 1 strain gauge.

### External dimensions

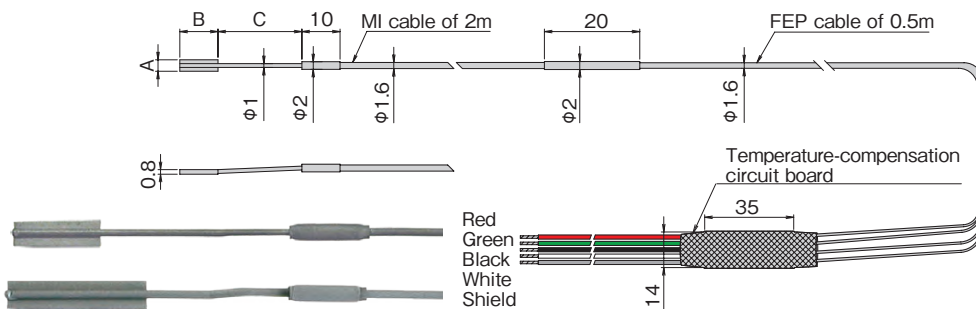

Type	A	B	C
AWHU-5	3	10	22
AWHU-8	3	16	16

### Note

Our AWH and AWHU series strain gauges are adjusted to make the thermal output as small as possible in consideration of the material to be measured, the MI cable length and the range of measurement temperature. These strain gauges will be supplied on made-to-order basis except AWH-4-7A-2-11.0 and AWH-8-7A-2-11.0.

\* Lead wire lengths other than the standard length are available on request. (Made to order: MI cable length is in increments of 1 meter. Vinyl cable length is in increments of 0.5 meters.)



# AW series (AW/AWC)

## AW-6-350

These gauges have corrosion-resisting stainless steel backing with thickness of 0.08mm. They are easily installed by using the dedicated spot welder W-50RC. are suited for strain measurement in high temperature up to 300° C, for measurement of specimen to which adhesion is not applicable or for long term measurement.

Type	Gauge length (mm)	Gauge base		Operating temperature (°C)	Temperature compensation range (°C)	Test specimen	Applicable coefficient of linear thermal expansion ( $\times 10^{-6}/^{\circ}\text{C}$ )	Resistance in ( $\Omega$ )
		Dimension (mm)	Materials					
AW-6-350-11-4FB01LT	6	L24xW5	SUS304	-196~+300°C	+10 ~ +100°C	Mild steel	$11 \times 10^{-6}/^{\circ}\text{C}$	350

Leadwire  $\Phi 0.2\text{mm}$  Twisted cross-linked fluorinated resin(PTFE) sheathed leadwire of 0.1m standard (Quarter bridge with 3-wire)

\* Lead wire lengths other than the standard length are available on request. (Made to order.)

Minimum order quantity is 5 strain gauges .

External dimensions

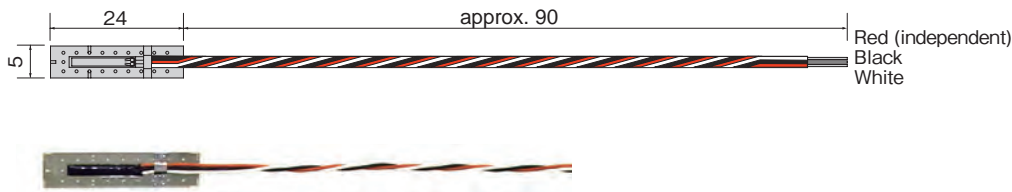

## AWC-8B

These gauges are fully encapsulated in a stainless steel tube. It enables long term strain measurement in harsh environment.

Type	Gauge length (mm)	Gauge base		Operating temperature (°C)	Temperature compensation range (°C)	Test specimen	Applicable coefficient of linear thermal expansion ( $\times 10^{-6}/^{\circ}\text{C}$ )	Resistance in ( $\Omega$ )
		Dimension (mm)	Materials					
AWC-8B-11-3LTSB	8	L28xW5xT1	SUS304	-20~+100°C	+10 ~ +100°C	Mild steel	$11 \times 10^{-6}/^{\circ}\text{C}$	120

Leadwire  $\Phi 5\text{mm}$  0.3mm<sup>2</sup> 3-core shielded vinyl leadwire of 3m standard (0.1 $\Omega$ /m) (Quarter bridge with 3-wire)

\* Lead wire lengths other than the standard length are available on request. (Made to order.)

Minimum order quantity is 1 strain gauge.

External dimensions

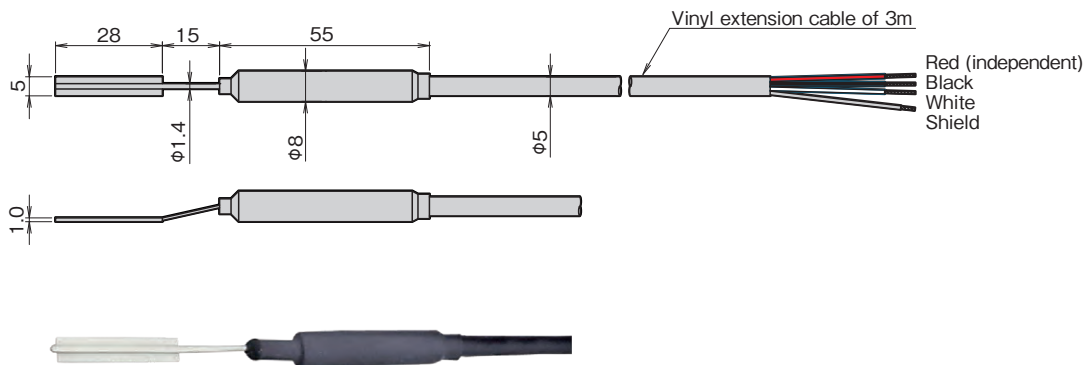



# Accessories/Options/Installation example (for weldable strain gauges)

## W-50RC SPOT WELDER



This is a spot welder used for installing weldable strain gauges and fixing leadwires. The welding energy is controlled in two ranges of 1-10 and 5-50 watt second. Its short welding pulse width of approximately 5 millisecond causes very little thermal damage on the material to be welded. The welding energy is not influenced by changes in the power source voltage owing to the adoption of stabilizing circuit. Electrical cables are stored inside the housing for convenience in field applications.

### Specifications

Welding energy	Two ranges of 1 to 10 watt second and 5 to 50 watt second (continuously variable) 60 watt second at maximum (AC110V 50Hz)
Output voltage	Approx. 32 V at maximum
Output pulse width	Approx. 5 millisecond
Welding interval	2 welds/second at maximum (at 50 watt second)
Continuous use time	Approx. 15 minutes (at 1 weld/second, 30 watt second, 23°C±5°C)
Welding holder	Holder type III
Welding force	4.9 to 19.6 N
Welding tip	Fixing part Φ3 mm, Tip Φ1 mm
Welding cable length	2m
Environment	0 to 50°C, 85%RH or less (no condensation)

Power supply	
Rated voltage	AC90 to 110V 50/60Hz or AC220V±10% 50/60Hz
Maximum power consumption	550 VA peak (160 millisecond) 210 VA/ 2 times/second
Dimensions	300(W) × 200(H) × 195(D) mm (except projecting parts)
Weight	Approx. 13 kg
Standard accessories	
Operation manual	1
AC power cable	1
Welding tip	3
Abrasive paper(#400)	5
Hexagonal wrench (width across flats 2.5 mm)	1
Shoulder belt	1

### Examples of option

F: Compression fittings

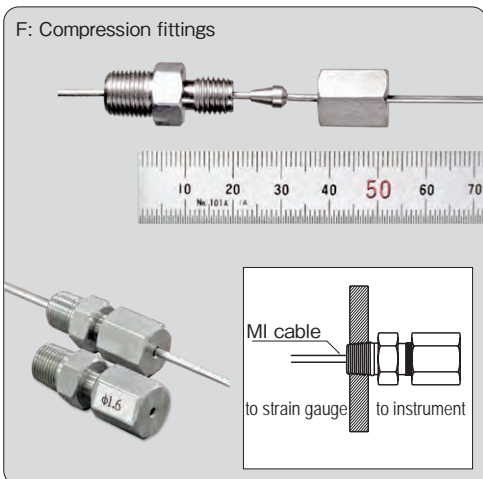

R: Bend of gauge backing or pipe



Weldable gauge AWHU and MI cable



Stainless steel ribbon  
Designed to fix cables

Size: 5mm x 10m x 0.08mm  
10mm x 10m x 0.08mm

### Strain gauge installation by resistance welding

#### Trial Welding (peeling test)

The dedicated spot welder is used for the installation of weldable strain gauges. In order to securely install the weldable strain gauge on the test object, it is necessary to find the welding conditions suited to the test object.

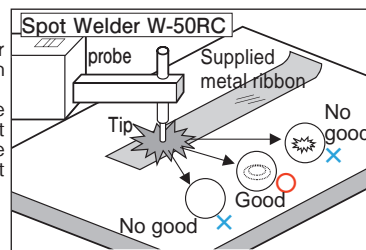

#### Fixing the sleeve A

Align the center of the strain gauge with the positioning mark, and press down on the gauge so that the gauge is flush against the test object. Fix the sleeve A using the supplied metal ribbon as shown in the figure.

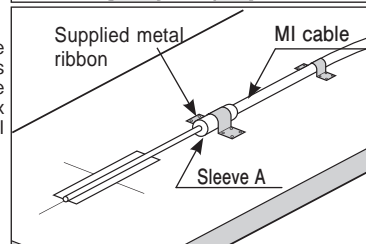

#### Fixing the cable

Fix the MI cable and the vinyl cable so as to avoid any load applied to the fixed sleeve A. Slightly curve the cable and fix it toward the direction of the cable end so that any excessive load is not applied to the cable. Especially, if the MI cable is fixed along a straight line, the sensing element may be damaged by a kink in the leadwire.

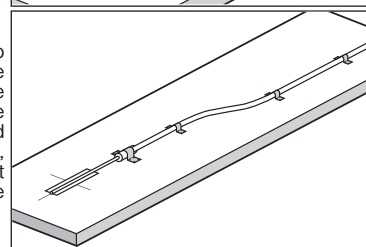

#### Temporarily fixing the gauge sensing part

Align the gauge sensing part with the positioning mark, and temporarily fix each one point on both sides of the strain gauge as shown in the figure by resistance welding.

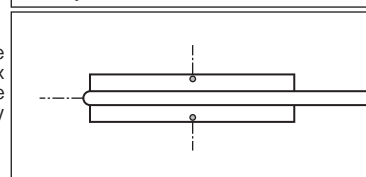

#### Order of resistance welding

Perform resistance welding in the order shown in the figure. The appropriate welding interval is approximately 0.8mm. Refer to the operation manual for the details.

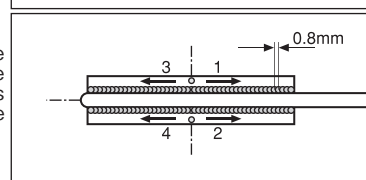



# Polyester Strain Gauges P series CE

These are wire strain gauges with a grid made of fine electric resistance wire formed on a polyester resin backing. They are used for measurement of surface strain on concrete, mortar or rocks, and also for short-term measurement on wood.

Operating temperature range	-20~+80°C	Applicable adhesives	CN-E -20~+80°C
Temperature compensation range	+10~+80°C	RP-2	-20~+80°C
		PS	-20~+80°C

Please specify the type number as shown in the example below.

**PL -60 -11 -3LJC-F**

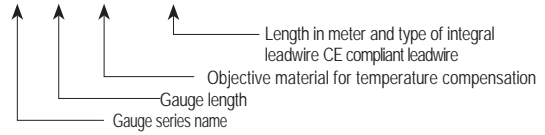

Objective material for temperature compensation (coefficient of linear thermal expansion  $\times 10^{-6}/^{\circ}\text{C}$ )  
-11: Concrete

Gauge pattern	Type	Gauge size(mm)		Backing size(mm)		Resistance $\Omega$	
		Length	Width	Length	Width		
● Single axis							
 PL-60-11	Single axis	PL-60-11	60	1	74	8	120
		PL-90-11	90	1	104	8	120
		PL-120-11	120	1	134	8	120
● 0°/90° 2-axis							
 PLC-60-11 $\mathcal{Q}$ (x1/4)	0°/90° 2-axis	PLC-60-11	60	1	74	74	120
● 0°/45°/90° 3-axis							
 PLR-60-11 $\mathcal{Q}$ (x1/4)	0°/45°/90° 3-axis	PLR-60-11	60	1	74	74	120

Minimum order quantity is 10 strain gauges.

## Dedicated leadwire recommended for P series strain gauges

We supply various leadwires dedicated to strain gauges so as to meet our customers' requirements. Please refer to page 32 to 40 for the details of combination of a strain gauge and a leadwire. For CE marked strain gauges, only the leadwires using lead-free solder are available.

### Type and designation of leadwires

Usage	Leadwire name	Operating temperature range of leadwire (°C)	Type number example
General purpose (without temperature change)	Paralleled vinyl LJB-F Paralleled vinyl LJC-F	-20 ~ +80	PL-60-11-3LJB-F PL-60-11-3LJC-F
General use	3-wire paralleled vinyl LJBT-F 3-wire paralleled vinyl LJCT-F	-20 ~ +80	PL-60-11-3LJBT-F PL-60-11-3LJCT-F
1-Gauge 4-Wire measurement	Polypropylene 4-wire paralleled LQM-F	-20 ~ +100	PL-60-11-3LQM-F (modular plug attached)

NB: No integral leadwire is available for rosette strain gauges PLC and PLR.



# Polyester Foil Strain Gauges PF series $\text{C}\epsilon$

These are foil strain gauges utilizing a polyester resin backing which is the same as the P series. The gauge length is available in 3 ranges of 10, 20 and 30mm, so it is suited mainly to strain measurement on concrete or mortar.

Operating temperature range	-20~+80°C	Applicable adhesives	
Temperature compensation range	+10~+80°C	CN-E	-20~+80°C
		RP-2	-20~+80°C
		PS	-20~+80°C

Please specify the type number as shown in the example below.

**PFL -30 -11 -3LJC-F**

↑ ↑ ↑ ↑

Length in meter and type of integral leadwire CE compliant leadwire  
Objective material for temperature compensation  
Gauge length  
Gauge series name

Objective material for temperature compensation (coefficient of linear thermal expansion  $\times 10^{-6}/^{\circ}\text{C}$ )  
-11: Concrete

Gauge pattern	Type	Gauge size(mm)		Backing size(mm)		Resistance $\Omega$	
		Length	Width	Length	Width		
<b>● Single axis</b>  PFL-10-11      PFL-20-11  PFL-30-11	Single axis	PFL-10-11	10	0.9	17.5	5	120
		PFL-20-11	20	1.2	28	6	120
		PFL-30-11	30	2.3	40	7	120
<b>● 0° / 90° 2-axis</b>  PFLC-20-11 Q(x1/2)      PFLC-30-11 Q(x1/2)	0°/90° 2-axis	PFLC-20-11	20	1.2	28	28	120
		PFLC-30-11	30	2.3	40	40	120
<b>● 0° / 45° / 90° 3-axis</b>  PFLR-20-11 Q(x1/2)      PFLR-30-11 Q(x1/2)	0°/45°/90° 3-axis	PFLR-20-11	20	1.2	28	28	120
		PFLR-30-11	30	2.3	40	40	120

Minimum order quantity is 10 strain gauges.

## Dedicated leadwire recommended for PF series strain gauges

We supply various leadwires dedicated to strain gauges so as to meet our customers' requirements. Please refer to page 32 to 40 for the details of combination of a strain gauge and a leadwire. For CE marked strain gauges, only the leadwires using lead-free solder are available.

### Type and designation of leadwires

Usage	Leadwire name	Operating temperature range of leadwire (°C)	Type number example
General purpose (without temperature change)	Paralleled vinyl LJB-F Paralleled vinyl LJC-F	-20 ~ +80	PFL-10-11-3LJB-F PFL-10-11-3LJC-F
General use	3-wire paralleled vinyl LJBT-F 3-wire paralleled vinyl LJCT-F	-20 ~ +80	PFL-10-11-3LJBT-F PFL-10-11-3LJCT-F
1-Gauge 4-Wire measurement	Polypropylene 4-wire paralleled LQM-F	-20 ~ +100	PFL-10-11-3LQM-F (modular plug attached)

NB: No integral leadwire is available for rosette strain gauges PFLC and PFLR.



# Metal Backing Strain Gauges FLM/WFLM series



These strain gauges have thin stainless steel backings which prevent the penetration of moisture from the reverse sides. This construction is aimed for successful strain measurement on concrete surface. The WFLM gauges have moisture proofing over-coating and integral leadwire in addition to the stainless steel backing. It is intended for long term measurement or measurement on underwater-curing concrete.

Operating temperature range -20~+80°C	Applicable adhesives PS -20~+80°C
Temperature compensation range +10~+80°C	

Please specify the type number as shown in the example below.

**FLM -30 -11 -2LJCT**

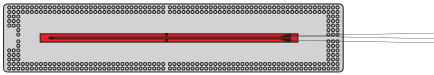
Objective material for temperature compensation (coefficient of linear thermal expansion  $\times 10^{-6}/^{\circ}\text{C}$ )  
-11: Concrete

Gauge pattern	Type	Gauge size(mm)		Backing size(mm)			Resistance $\Omega$	
		Length	Width	Length	Width	Thickness		
<b>●Single axis</b>								
 FLM-60-11      Q (×1/2)	Single axis	FLM-30-11	30	0.5	60	18	0.12	120
			FLM-60-11	60	0.7	90	18	0.12
Minimum order quantity is 10 strain gauges. These strain gauges are available with integral leadwires attached. (made to order)								
<b>●Waterproof Type Single axis</b>								
0.09mm <sup>2</sup> 3-wire twisted cross-linked polyethylene integral leadwire of 2m -2LJQTA Total leadwire resistance per meter : 0.4 $\Omega$ NB: Integral leadwire length longer than 2m is available.								
 WFLM-60-11-2LJQTA      Q (×1/2)	Waterproof type	WFLM-30-11	30	0.5	60	18	4	120
	Single axis	WFLM-60-11	60	0.7	90	18	4	120
Minimum order quantity is 10 strain gauges.								



# Mold Strain Gauges PMF series

These gauges are designed for the measurement of internal strain of concrete or mortar under loading test. These can also be used for short-term measurement of the behavior of concrete. These are embedded into the measurement position when the concrete or mortar is placed. The gauges employ super engineering plastics as the backing for sealing the sensing element, which provides excellent waterproofing. A temperature-integrated type PMFL-T is available for measurement of both strain and temperature using our data loggers.

Operating temperature range  $-20 \sim +60^{\circ}\text{C}$

Please specify the type number as shown in the example below.

**PMFL -50 (-F) -2LJRTA (-F)**

Gauge pattern	Type	Gauge Length(mm)	Backing (mm)				Resistance $\Omega$
			a	b	c	d	
<b>●Single axis</b> 3-wire system  PMFL-50-2LJRTA Black Green Red (independent)	PMFL-50	50	60	$\phi 8$	$\phi 4$	27	120
	PMFL-60	60	70	$\phi 8$	$\phi 4$	32	120
0.09mm <sup>2</sup> 3-wire cross-linked vinyl leadwire of 2m -2LJRTA Total leadwire resistance per meter : 0.4 $\Omega$							
<b>●Temperature sensor integrated</b> 3-wire system Refer to page 16 for details of Temperature-integrated strain gauge.  PMFL-50T-3TLJBT Blue (Cu) White (Cu-Ni) Red (Cu-independent)	PMFL-50T	50	60	$\phi 8$	$\phi 4$	27	120
	PMFL-60T	60	70	$\phi 8$	$\phi 4$	32	120
0.08mm <sup>2</sup> integral cross-linked vinyl leadwire of 3m -3TLJBT Total leadwire resistance per meter : 0.44 $\Omega$ (Loop resistance for copper core wires) * These gauges are made to order.							

**Note**  
For long-term measurement of concrete structure, use Strain Transducer KM



# Asphalt Mold Strain Gauges PMFLS series

These gauges are embedded in asphalt and used for strain measurement in loading test such as rolling compaction. The material of the backing is super engineering plastics featuring high temperature resistivity and waterproofing performance. The gauges withstand a high temperature up to 200°C during placement of asphalt, and the operating temperature range is  $-20 \sim +60^{\circ}\text{C}$ .

Operating temperature range  $-20 \sim +60^{\circ}\text{C}$

Please specify the type number as shown in the example below.

**PMFLS -60 -50 (-F) -2LTSC (-F)**

Gauge pattern	Type	Gauge Length(mm)	Backing (mm)				Resistance $\Omega$
			a	b	c	d	
<b>●Single axis</b> 3-wire system  PMFLS-60-50-2LTSC Black White Red (independent) Shield	PMFLS-60-50	60	120	13	Approx. 7	60	120
$\phi 6\text{mm}$ 3-wire shielded chloroprene cable of 2m -2LTSC Total leadwire resistance per meter : 0.11 $\Omega$							

Minimum order quantity is 1 strain gauge.



# Strain Transducers KM/KM-HAS series

## Strain measurement in concrete, mortar and synthetic resin including their early stage of curing

These strain transducers are designed for measurement of strain in materials such as concrete, mortar or synthetic resin. Measurement is possible not only after the material is cured but also during the stage of curing.

The elastic modulus of the transducers is equivalent to approximately 40N/mm<sup>2</sup>. Therefore, measurement is possible right after the concrete is placed.

The waterproof construction of the transducers makes the transducers totally impervious to moisture absorption and offers excellent stability for long-term strain measurement. The thermocouple-integrated transducers enable real temperature measurement simultaneously with strain measurement, greatly saving the wiring works. In addition to the internal strain measurement, surface strain measurement on concrete or steel such as H-beam steel is also available using various optional accessories.

The KM series is compliant to CE marking except for KM-30 and KM-50F.

Protection ratings IP67 equivalent (KM-30)  
IP68 equivalent (KM-50 - KM-100BT)



### Features

- Self-temperature-compensation with coefficient of thermal expansion close to concrete
- Measurement from early stage of concrete curing possible due to the low elastic modulus
- Simultaneous measurement of strain and temperature possible (except KM-30, KM-50F)
- Surface strain measurement on bracing for earth retaining or steel sheet pile

### External dimensions

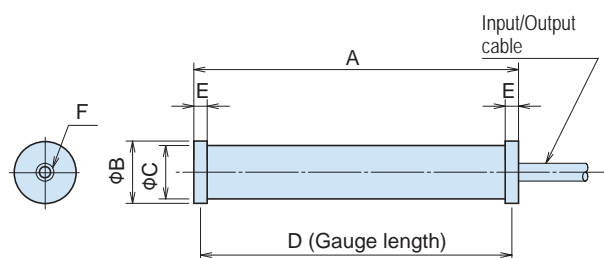

TYPE	Dimensions (mm)						Weight (g)
	A	φB	φC	D	E	F	
KM-30	34	12	10	31	3	M3 DP 4	12
KM-50F	54	20	17	50	4	M3 DP 6	45
KM-100B	104	20	17	100	4	M3 DP 6	75
KM-100HB	104	20	17	100	4	M3 DP 6	80
KM-100BT	104	20	17	100	4	M3 DP 6	75

### KM-100HAS for asphalt pavement

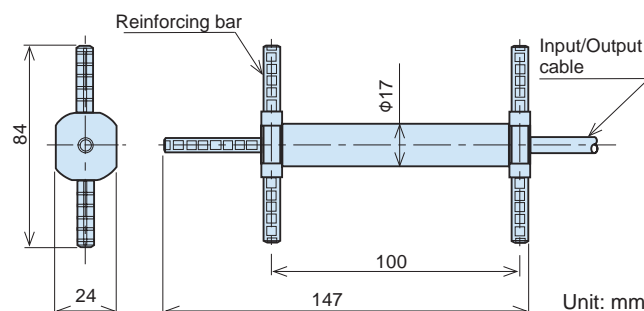

This transducer is embedded into asphalt for measurement of internal strain. It has reinforcing bar flanges at its both ends for good fixation to asphalt pavement materials. The operating temperature range of the transducer is -20 to +180°C, and it has fully waterproof construction.

### Specifications

Type	KM-30	KM-50F	KM-100B	KM-100HB	KM-100HAS	KM-100BT
Capacity	±5000 x 10 <sup>-6</sup> strain					
Gauge length	31mm	50mm	100mm			
Rated output (Approx.)	2.5mV/V (5000 x 10 <sup>-6</sup> )	4mV/V (8000 x 10 <sup>-6</sup> )	2.5mV/V (5000 x 10 <sup>-6</sup> )			
Nonlinearity	1%RO					
Apparent elastic modulus	Approx. 40N/mm <sup>2</sup>					
Temperature measurement	N/A		*1 Strain gauge (350Ω Quarter bridge 3-wire method :50x 10 <sup>-6</sup> strain/°C)			*2 Thermocouple T
Allowable temperature range	-20~+60°C	-20~+80°C		-20~+180°C		-20~+80°C
Input/Output resistance	120Ω Half bridge		350Ω Full bridge			

In addition to the above, special products such as for the use in asphalt or roller compacted concrete are available. Please contact us. \*1 Relative temperature measurement possible  
KM-30 and KM-50F are not CE marked. \*2 Real temperature measurement possible

### Input/Output cable

KM-30	2.4mm dia.	0.04mm <sup>2</sup>	3-core shielded Vinyl cable	2m cable-end free
KM-50F	6mm dia.	0.35mm <sup>2</sup>	4-core shielded chloroprene cable	2m cable-end free
KM-100B	9mm dia.	0.3mm <sup>2</sup>	5-core shielded chloroprene cable	2m cable-end free
KM-100HB/-100HAS	6mm dia.	0.3mm <sup>2</sup>	5-core shielded fluoroplastic cable	2m cable-end free
KM-100BT	9mm dia.	0.3mm <sup>2</sup>	4-core shielded T-thermocouple compound cable	2m cable-end free



## ■ When using for measurement of internal strain

Measurement of internal strain of concrete structure is possible not only for the behavior after the curing but also for strain during the curing. Strain in structure is caused by several factors such as external force, ambient temperature, drying shrinkage and material creep. This transducer is designed to measure every strain generated.

The gauge length of the strain transducer should be about three times the maximum diameter of the aggregate or larger. For the measurement from the early age of the concrete, use the strain transducer KM-100B or KM-100BT.

### ● Installation example in reinforced concrete structures

When installing a strain transducer, wind a binding wire round two parts of the transducer body, and position the transducer in accordance with the marking previously marked on the reinforcing bars as in the figure.

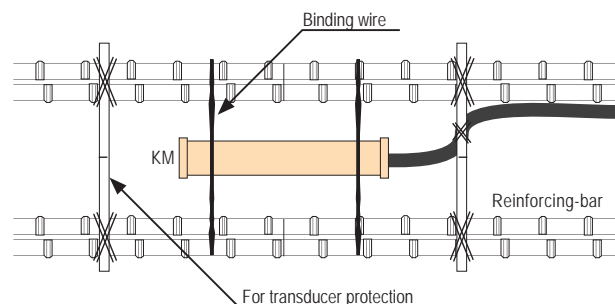

## ■ For surface strain measurement

Surface strain measurement on steel or concrete structures is available with KM-100B or KM-100BT. (Optional fittings such as Spacer and Collar are available for fixing the transducer and positioning the gauge length.)

### ● An installation onto the surface of steel structure



The KM model is combined with optional Collar KMF-22-100 to install onto the surface of steel by welding.

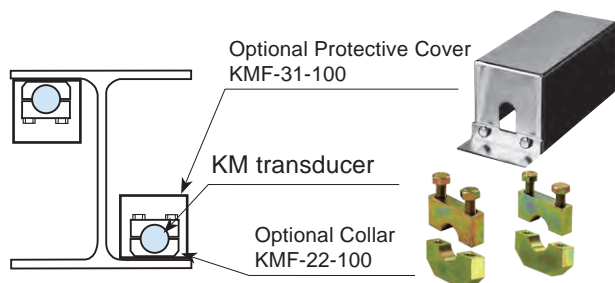

### ● An installation onto the surface of concrete structure

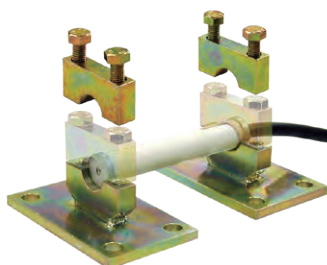

The KM model is combined with optional Collar KMF-23B-100 to install onto the surface of concrete structure with anchor bolts.

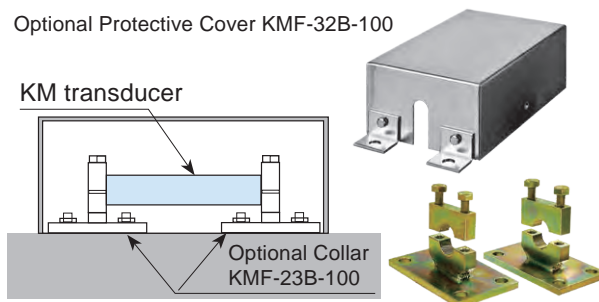



# Strain Gauges UBF series $\text{C}\epsilon$

These are foil strain gauges developed for measurement on composite materials. They have a specially designed grid pattern to reduce the stiffening effect of the strain gauges. In addition, owing to the development of gauge backing with better compliance, the number of repetition in thermal cycling test and the creep characteristics have been significantly improved compared to conventional strain gauges.

\* The strain gauge of this series is not self-temperature-compensated. The thermal output should be measured prior to the actual measurement using a dummy test piece.

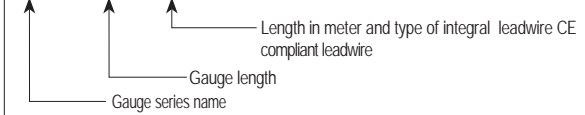

Please specify the type number as shown in the example below.

**UBFLA -1 -3LJB-F**



Operating temperature range  
-30~+150°C  
Temperature compensation range  
N/A

Applicable adhesives  
CN -30~+120°C  
EB-2 -30~+150°C

Gauge pattern	Type	Gauge size(mm)		Backing size(mm)		Resistance $\Omega$
		Length	Width	Length	Width	
<p>● Single axis</p>  <p>UBFLA-03 <math>\text{Q}(\times 3)</math></p>  <p>UBFLA-1 <math>\text{Q}(\times 3)</math></p>	UBFLA-03	0.3	1.9	3.4	2.5	120
	UBFLA-1	1	1.3	4.5	2	120

Minimum order quantity is 10 strain gauges.  
These strain gauges are available with integral leadwires attached. (made to order)



### Important point

Composite materials made of plastics reinforced with glass fibers (GFRP), carbon fibers (CFRP) or aramid fibers (AFRP) have different elastic modulus and coefficient of linear thermal expansion depending on the direction of the fibers. When measuring strain on composite materials, pay enough attention to its components and the direction of the fibers.



# Strain Gauges **BF** series (GOBLET) **CE**



These are strain gauges designed for measurement on composite materials. They have a specially designed grid pattern to reduce the stiffening effect of the strain gauge to the measurement object. Coefficient of linear thermal expansion for temperature compensation is available in 3, 5, and  $8 \times 10^{-6}/^{\circ}\text{C}$ , which are applicable to ceramic, carbon or composite materials. These strain gauges are CE marked (compliant to RoHS2 Directive). They have joined to our "GOBLET" series.

Operating temperature range	-30~+200°C	Applicable adhesives	CN-E	-30~+120°C
Temperature compensation range	+10~+80°C	NP-50B	-30~+200°C	
		EB-2	-30~+200°C	

Please specify the type number as shown in the example below.

**BFLAB -2 -3 -3LJC-F**

↑ Gauge series name    ↑ Gauge length    ↑ Objective material for temperature compensation    ↑ Length in meter and type of integral leadwire CE compliant leadwire

Objective material for temperature compensation (coefficient of linear thermal expansion  $\times 10^{-6}/^{\circ}\text{C}$ )  
 -3, -5, -8: Composite material   (marked on the backing)

Note: The backing color of BF series gauges are the same for every material for temperature compensation.

Gauge pattern	Type	Gauge size(mm)		Backing size(mm)		Resistance Ω
		Length	Width	Length	Width	
<b>● Single axis</b>  Coefficient of linear thermal expansion of objective material (3,5,8)	Single axis					
	BFLAB-2	2	0.9	7.6	2.5	120
	BFLAB-5	5	1.5	12.3	3.3	120
<b>● 0°/90° 2-axis Plane type</b>  BFCAB-2    BFCAB-5	0°/90° 2-axis					
	BFCAB-2	2	1.3	8	8	120
	BFCAB-5	5	1.5	11.5	11.5	120
<b>● 0°/45°/90° 3-axis Plane type</b>  BFRAB-2    BFRAB-5	0°/45°/90° 3-axis					
	BFRAB-2	2	1.3	8	8	120
	BFRAB-5	5	1.5	11.5	11.5	120

**Important point**

Composite materials made of plastics reinforced with glass fibers (GFRP), carbon fibers (CFRP) or aramid fibers (AFRP) have different elastic modulus and coefficient of linear thermal expansion depending on the direction of the fibers. When measuring strain on composite materials, pay enough attention to its components and the direction of the fibers.

Minimum order quantity is 10 strain gauges.  
 These strain gauges are available with integral leadwires attached. (made to order)

## Dedicated leadwires recommendable for BF series strain gauge(made to order)

We supply various leadwires dedicated to strain gauges so as to meet our customers' requirements. Please refer to page 32 to 40 for the details of combination of a strain gauge and a leadwire. For CE marked GOBLET series strain gauges, only the leadwires using lead-free solder are available.

### Type and designation of leadwires

Usage	Leadwire name	Operating temperature range of leadwire (°C)	Type number example
General purpose (without temperature change)	Parallel vinyl leadwire LJC-F	-20 ~ +80	BFLAB-2-3-3 <b>LJC-F</b>
General purpose	3-wire parallel vinyl leadwire LJCT-F	-20 ~ +80	BFLAB-2-3-3 <b>LJCT-F</b>
Medium high temperature	3-wire parallel special vinyl leadwire LXT-F	-20 ~ +150	BFLAB-2-3-3 <b>LXT-F</b>
High temperature	3-wire twisted FEP leadwire 6FA □ LT-F 3-wire twisted FEP single-core leadwire 6FB □ LT-F	-269 ~ +200	BFLAB-2-3-6 <b>FA3LT-F</b> BFLAB-2-3-6 <b>FB3LT-F</b>

NB: □ shows the lead wire length in meter



# Strain Gauges GF series €€



These strain gauges are suited to the measurement on materials such as plastics, which have low elastic modulus compared to metal. Our original specially-designed grid lowers the rigidity of the strain gauge and reduces the stiffening effect to the specimen material.

These strain gauges are CE marked (compliant to RoHS2 Directive) and have joined to our "GOBLET" series.

Operating temperature range -30~+80°C	Applicable adhesives CN -30~+80°C
Temperature compensation range +10~+80°C	

Please specify the type number as shown in the example below.

**GFLAB -3 (-350) -50 -3LJC-F**

Labels for GFLAB -3 (-350) -50 -3LJC-F:  
 - Gauge series name: GFLAB  
 - Gauge length: -3  
 - Gauge resistance (blank for 120Ω): (-350)  
 - Objective material for temperature compensation: -50  
 - Length in meter and type of integral leadwire CE compliant leadwire: -3LJC-F

Objective material for temperature compensation (coefficient of linear thermal expansion  $\times 10^{-6}/^{\circ}\text{C}$ )  
 -50: Epoxy resin       -70: Acrylic resin, ABS resin

Gauge pattern	Type	Gauge size(mm)		Backing size(mm)		Resistance Ω
		Length	Width	Length	Width	
<p>● Single axis</p>	GFLAB-3	3	2.3	9.5	4	120
	GFLAB-6	6	2.5	14	5	120
	GFLAB-3-350	3	2.9	9.5	5	350
	GFLAB-6-350	6	2.7	14	5	350
<p>● 0° / 90° 2-axis Plane type</p>	GFCAB-3	3	1.4	10.5	10.5	120
	GFCAB-3-350	3	2.9	14.5	14.5	350
<p>● 0° / 45° / 90° 3-axis Plane type</p>	GFRAB-3	3	1.4	10.5	10.5	120
	GFRAB-3-350	3	2.9	14.5	14.5	350

Minimum order quantity is 10 strain gauges.



### Important point

#### ● Influence of elastic modulus

A strain gauge bonded on a material having low elastic modulus such as plastics may disturb the stress distribution of the material around the area where the strain gauge is bonded. It may cause an apparent lowering of the gauge factor of the strain gauge. This is called a stiffening effect of strain gauge. The lower the elastic modulus is, the larger the stiffening effect becomes. The gauge factor correction is necessary if the elastic modulus of the test object is approx. 2.9 GPa (300 kgf/mm<sup>2</sup>) or lower.

#### ● Effect of Joule heat

The strain gauge of this series has a specially designed grid to reduce the effect of Joule heat in the strain gauge. The allowable current for a strain gauge is 30 mA when it is bonded on a metal. However, if the strain gauge is bonded on plastics, it is recommended to keep the current at 10 mA or less.



# Strain Gauges LF series CE



This is a foil strain gauge utilizing special plastics for the backing. It has a grid designed for materials with low elastic modulus, and the stiffening effect on the measurement object is reduced. This strain gauge is CE marked (compliant to RoHS2 Directive) and has joined to our "GOBLET" series.

Please specify the type number as shown in the example below.

**LFLAB -10 -11 -3LJC-F**

- LFLAB: Gauge series name
- 10: Gauge length
- 11: Objective material for temperature compensation
- 3LJC-F: Length in meter and type of integral leadwire CE compliant leadwire

Objective material for temperature compensation (coefficient of linear thermal expansion  $\times 10^{-6}/^{\circ}\text{C}$ )  
 -11: Wood, Gypsum

Operating temperature range -30~+80°C	Applicable adhesives CN-E -30~+80°C
Temperature compensation range +10~+80°C	

Gauge pattern	Type	Gauge size(mm)		Backing size(mm)		Resistance Ω
		Length	Width	Length	Width	
● Single axis  LFLAB-10-11	LFLAB-10-11	10	3.1	18.5	5.3	120

Minimum order quantity is 10 strain gauges.  
 These strain gauges are available with integral leadwires attached. (made to order)

## Dedicated leadwire recommended for LF series strain gauges (made to order)

We supply various leadwires dedicated to strain gauges so as to meet our customers' requirements. Please refer to page 32 to 40 for the details of combination of a strain gauge and a leadwire. For CE marked GOBLET series strain gauges, only the leadwires using lead-free solder are available.

### Type and designation of leadwires (GOBLET)

Usage	Leadwire name	Operating temperature range of leadwire (°C)	Type number example
General purpose (without temperature change)	Paralleled vinyl LJB-F	-20 ~ +80	LFLAB-10-11-3 <b>LJB-F</b>
	Paralleled vinyl LJC-F		LFLAB-10-11-3 <b>LJC-F</b>
General use	3-wire paralleled vinyl LJBT-F	-20 ~ +80	LFLAB-10-11-3 <b>LJBT-F</b>
	3-wire paralleled vinyl LJCT-F		LFLAB-10-11-3 <b>LJCT-F</b>
1-Gauge 4-Wire measurement	Polypropyrene 4-wire paralleled LQM-F	-20 ~ +80	LFLAB-10-11-3 <b>LQM-F</b> (modular plug attached)



# Strain Gauges PFLW/PLW series

These gauges are specially designed for long term measurement on wood. They have a metal foil lined on the back of the PFL or PL strain gauges. The metal foil is effective to protect the strain gauges from an influence of moisture in the wood. These gauges should be bonded with PS adhesive to make the best of their performance.

Operating temperature range -20~+80°C	Applicable adhesives PS -20~+80°C
Temperature compensation range +10~+80°C	

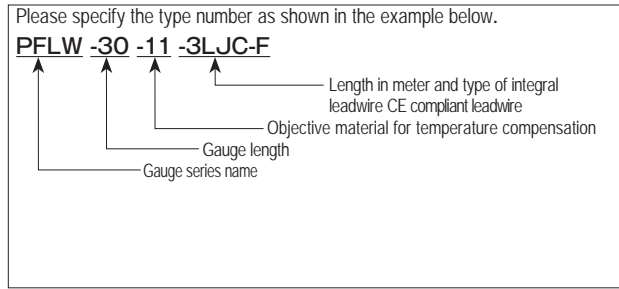

Gauge pattern	Type	Gauge size(mm)		Backing size(mm)		Resist- ance Ω
		Length	Width	Length	Width	
<p>●Single axis</p> <p>PFLW-30-11</p> <p>PLW-60-11</p>						
	PFLW-30-11	30	2.3	40	7	120
	PLW-60-11	60	1	74	8	120

Minimum order quantity is 10 strain gauges.

## Dedicated leadwire recommended for PFLW/PLW series strain gauges

We supply various leadwires dedicated to strain gauges so as to meet our customers' requirements. Please refer to page 32 to 40 for the details of combination of a strain gauge and a leadwire.

### Type and designation of leadwires

Usage	Leadwire name	Operating temperature range of leadwire (°C)	Type number example
General purpose (without temperature change)	Paralleled vinyl LJB-F	-20 ~ +80	PFLW-30-11-3LJB-F
	Paralleled vinyl LJC-F		PFLW-30-11-3LJC-F
General use	3-wire paralleled vinyl LJBT-F	-20 ~ +80	PFLW-30-11-3LJBT-F
	3-wire paralleled vinyl LJCT-F		PFLW-30-11-3LJCT-F
1-Gauge 4-Wire measurement	Polypropyrene 4-wire paralleled LQM-F	-20 ~ +80	PFLW-30-11-3LQM-F (modular plug attached)



# Non-inductive Strain Gauges MF series

These are non-inductive strain gauges suited to the measurement in magnetic field. The sensing element of this gauge consists of two identical grids with one grid folded back on another. This construction makes to cancel the electromagnetically induced noise each other. The twisted leadwire is also effective to cancel the induced noise in the same way. Accordingly, this strain gauge is less sensitive to the influence of noise induced in changing magnetic field.

Operating temperature range -20~+80°C	Applicable adhesives	
	CN	-20~+80°C
	CN-E	-20~+80°C
	RP-2	-20~+80°C

Please specify the type number as shown in the example below.

**MFLA -2 -350 -11 -1LJAY**

- MFLA: Gauge series name
- 2: Gauge length
- 350: Gauge resistance (blank for 120Ω)
- 11: Objective material for temperature compensation
- 1LJAY: Length in meter and type of integral leadwire

Objective material for temperature compensation (coefficient of linear thermal expansion  $\times 10^{-6}/^{\circ}\text{C}$ )

-11: Mild steel (red) -17: Stainless steel (orange) -23: Aluminium (green)

## Single axis (for concrete)

Gauge pattern	Type	Gauge size(mm)		Backing size(mm)		Resistance Ω
		Length	Width	Length	Width	
MFLA-60-350		60	0.1	64	5	350

### ● Single axis (for concrete)



MFLA-60-350-□-1LJAY Used leadwire: 0.08mm<sup>2</sup> twisted vinyl leadwire 1 m  
Loop resistance per 1 m: 0.44Ω



MFLA-60-350-□-1LS (Shielded leadwire)  
Used leadwire: 3.2 mm dia. 2-core twisted shielded vinyl leadwire 1 m  
Loop resistance per 1 m: 0.44Ω

Minimum order quantity is 10 strain gauges.

NB: □ shows the objective material for temperature compensation ( $\times 10^{-6}/^{\circ}\text{C}$ )

## Multi-axis (for high temperature use)

Multi-axis strain gauges of this series utilize polyimide resin for the backing and they are applicable to the measurement in high temperature.

Operating temperature range -20~+200°C	Applicable adhesives	
	CN	-20~+80°C
	NP-50B	-20~+200°C

Please specify the type number as shown in the example below.



**MFCAL -2 (-350) -11 -6FD1LTS**

- MFCAL: Gauge series name
- 2: Gauge length
- (-350): Gauge resistance (blank for 120Ω)
- 11: Objective material for temperature compensation
- 6FD1LTS: Length in meter and type of integral leadwire

Objective material for temperature compensation (coefficient of linear thermal expansion  $\times 10^{-6}/^{\circ}\text{C}$ )

-11: Mild steel -17:Stainless steel -23:Aluminium -28:Magnesium (yellow)

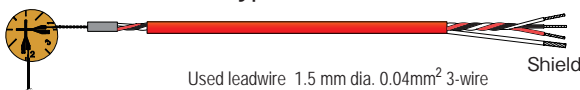
Note: The backing color of MF series gauges are the same for every material for temperature compensation.

Gauge pattern	Type	Gauge size(mm)		Backing size(mm)		Resistance Ω
		Length	Width	Length	Width	
<b>● 2-axis 0° /90° Stacked type</b>  MFCAL-2-□-6FD1LTS Used leadwire: 1.5 mm dia. 0.04mm <sup>2</sup> 3-wire twisted shielded FEP leadwire 1 m Loop resistance per 1 m: 1.1 Ω	MFCAL-2	2	0.1	φ 7		120
	MFCAL-2-350	2	0.2	φ 7		350
<b>● 3-axis 0° /45° /90° Stacked type</b>  MFRAL-2-□-6FD1LTS Used leadwire: 1.5 mm dia. 0.04mm <sup>2</sup> 3-wire twisted shielded FEP leadwire 1 m Loop resistance per 1 m: 1.1 Ω	MFRAL-2	2	0.1	φ 7		120
	MFRAL-2-350	2	0.2	φ 7		350

Minimum order quantity is 10 strain gauges.

The length of integral leadwire for multi-axis strain gauges of this series is available up to 1 meter.

NB: □ shows the objective material for temperature compensation ( $\times 10^{-6}/^{\circ}\text{C}$ )



# Non-inductive Strain Gauges QMF series

These are non-inductive strain gauges suited to the measurement in magnetic field. The sensing element of this gauge consists of two identical grids with one grid folded back on another. This construction makes to cancel the electromagnetically induced noise each other. The twisted leadwire is also effective to cancel the induced noise in the same way. Accordingly, this strain gauge is less sensitive to the influence of noise induced in changing magnetic field.

Operating temperature range	-30~+200°C	Applicable adhesives	CN -30~+120°C
Temperature compensation range	0~+150°C	NP-50B	-30~+200°C

Please specify the type number as shown in the example below.

**QMFLA -2 (-350) -11 -005LET-6FD1LTSS-F**

↑ Gauge series name    ↑ Gauge length    ↑ Gauge resistance (blank for 120Ω)    ↑ Objective material for temperature compensation    ↑ 3-wire from the root of gauge leads (blank for 2-wire)    ↑ Length in meter and type of integral leadwire CE Compliant leadwire

Objective material for temperature compensation (coefficient of linear thermal expansion  $\times 10^{-6}/^{\circ}\text{C}$ )  
 -11: Mild steel    -17: Stainless steel    -23: Aluminium

Note: The backing color of QMF series gauges are the same for every material for temperature compensation.

## Single axis (for steel)

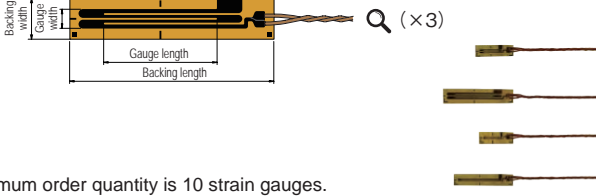
Gauge pattern	Type	Gauge size (mm)		Backing size (mm)		Resistance (Ω)
		Length	Width	Length	Width	
 <p>• Single axis</p> <p>• Minimum order quantity is 10 strain gauges.</p> <p>• These strain gauges need to be supplied with integral leadwires (made-to-order).</p>	QMFLA-2	2	0.5	5	1.5	120
	QMFLA-5	5	0.8	9	1.8	120
	QMFLA-2-350	2	0.3	4.5	1.5	350
	QMFLA-5-350	5	0.3	7.8	1.5	350

### Important point

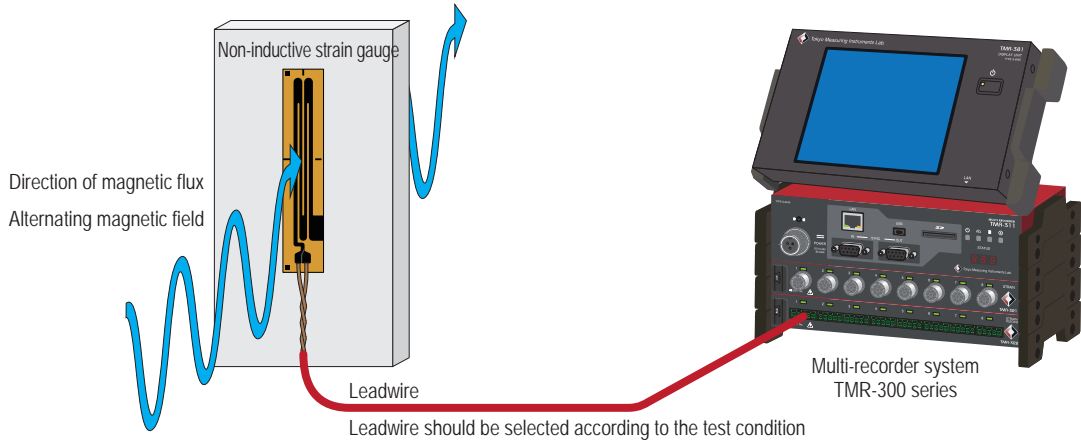

### Features



- Gauge resistance of 120 Ω is added to the product lineup
- Connection is selected from quarter bridge 2-wire, quarter bridge 3-wire and quarter bridge 3-wire (with 3-wire from the root of gauge leads) according to the test condition
- Operating temperature range is extended to -30 ~ +200°C (temperature compensation range to 0 ~ +150°C)
- Gauge lead length of approx. 50 mm allows easy bonding works (only for the gauges with 3-wire from the root of gauge leads)
- CE marked



## Strain Gauge Extension Leadwires Recommended for QMF Series

We offer various types of extension leadwires dedicated to strain gauges in order to satisfy customers' requirements.

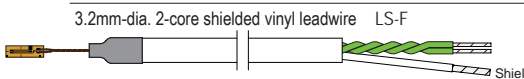
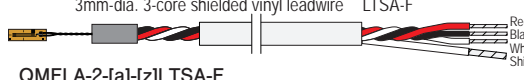
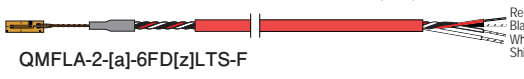
### Type and designation of leadwire

Application	Leadwire name	Operating temperature range of leadwire (°C)	Loop resistance per 1 meter (Ω)	Example of type number
Magnetic field Room temperature (without temperature change)	2-wire twisted vinyl leadwire LJAY-F  QMFLA-2-[a]-[z]LJAY-F	-20 ~ +80	0.44	QMFLA-2-11-1LJAY-F
	3.2mm-dia. 2-core shielded vinyl leadwire LS-F  QMFLA-2-[a]-[z]LS-F	-20 ~ +80	0.44	QMFLA-2-11-1LS-F
Magnetic field Room temperature	3mm-dia. 3-core shielded vinyl leadwire LTSA-F  QMFLA-2-[a]-[z]LTSA-F	-20 ~ +80	0.44	QMFLA-2-11-1LTSA-F
Magnetic field High temperature	1.5mm-dia. 3-core shielded fluorinated resin (FEP) leadwire 6FDOLTS-F  QMFLA-2-[a]-6FD[z]LTS-F	-30 ~ +200	1.1	QMFLA-2-11-6FD1LTS-F
Magnetic field Room temperature (with 3-wire from the root of gauge leads)	3mm-dia. 3-core shielded vinyl leadwire LTSAS-F  QMFLA-2-[a]-005LET-[z]LTSAS-F	-20 ~ +80	0.44	QMFLA-2-11-005LET-1LTSAS-F
Magnetic field High temperature (with 3-wire from the root of gauge leads)	1.5mm-dia. 3-core shielded fluorinated resin (FEP) leadwire 6FDOLTSS-F  QMFLA-2-[a]-005LET-6FD[z]LTSS-F	-30 ~ +200	1.1	QMFLA-2-11-005LET-6FD1LTSS-F

[a] : Objective material for temperature compensation (coefficient of linear thermal expansion  $\times 10^{-6} / ^\circ\text{C}$ )

[z] : Leadwire length (m)

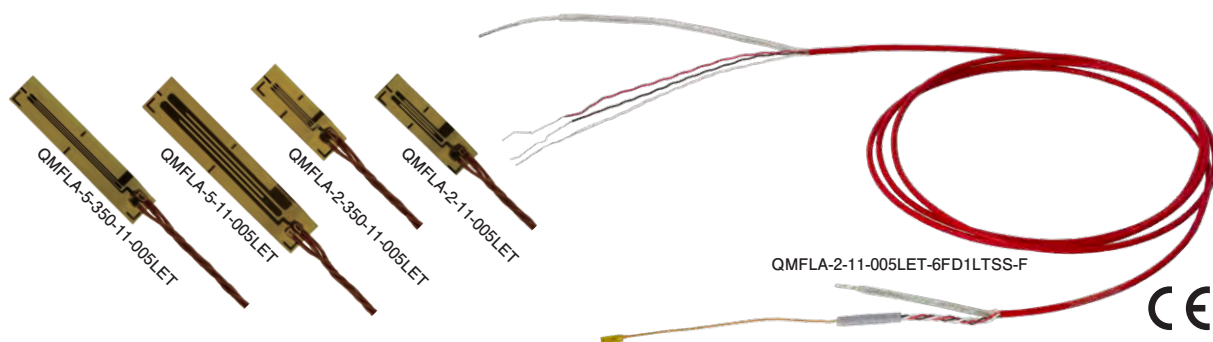



# Post-yield Strain Gauges YEF series NEW

These gauges are applicable to the measurement of large strain up to 10~15%. Also these withstand the repeated strain in elastic range (at strain level  $\pm 1500 \times 10^{-6}$  strain) like ordinary strain gauges. However, these are not applicable to the measurement of repeated strain in a large range. Integral leadwires using lead-free solder are available with option -F. This strain gauge is CE marked (compliant to RoHS2 Directive) and has joined to our "GOBLET" series.

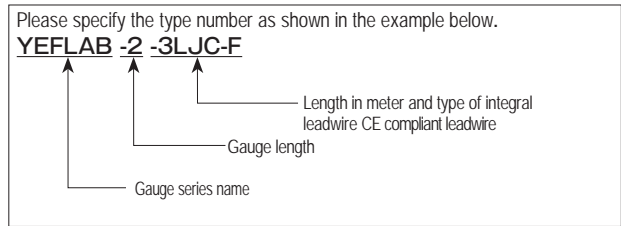

Operating temperature range	-30~+80°C	Applicable adhesives	
Strain limit in room-temperature	10~15%	CN	-30~+80°C
		CN-Y	-30~+80°C

Gauge pattern	Type	Gauge size(mm)		Backing size(mm)		Resistance $\Omega$	
		Length	Width	Length	Width		
<p>● Single axis</p> YEFLAB-2            YEFLAB-5	Single axis	YEFLAB-2	2	1.8	7	4	120
		YEFLAB-5	5	2	10.5	4	120
<p>● 0° /90° 2-axis Plane type</p> YEFCAB-2            YEFCAB-5	0°/90° 2-axis Plane type	YEFCAB-2	2	1.8	9.5	9.5	120
		YEFCAB-5	5	2	13.5	13.5	120
<p>● 0° /45° /90° 3-axis Plane type</p> YEFRAB-2            YEFRAB-5	0°/45°/90° 3-axis Plane type	YEFRAB-2	2	1.8	9.5	9.5	120
		YEFRAB-5	5	2	13.5	13.5	120

Minimum order quantity is 10 strain gauges.  
These strain gauges are available with integral leadwires attached. (made to order)

Post-yield (Large strain)

YEF series (GOBLET)

Single axis / Multi-axis



# Post-yield Strain Gauges YF series

These gauges are applicable to the measurement of large strain up to 15 to 20%. These are not applicable to the measurement of repeated strain in elastic range as well as in large range.

Operating temperature range	-20~+80°C	Applicable adhesives
Strain limit in room-temperature	15~20%	CN -20~+80°C
		CN-Y -20~+80°C

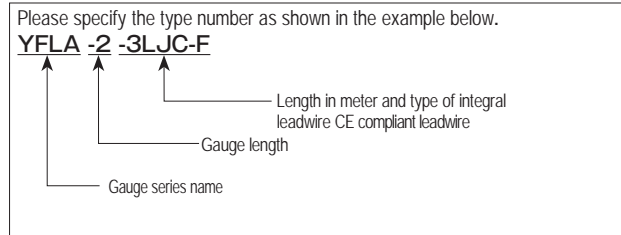

Gauge pattern	Type	Gauge size(mm)		Backing size(mm)		Resist-ance Ω
		Length	Width	Length	Width	
●Single axis						
YFLA-2	YFLA-2	2	1.8	7.5	4	120
YFLA-10	YFLA-10	10	2.6	16.6	4.9	120
YFLA-5	YFLA-5	5	1.9	12	4	120
YFLA-20	YFLA-20	20	1.8	26	3.7	120

Minimum order quantity is 10 strain gauges. These strain gauges are available with integral leadwires attached. (made to order)



# Post-yield Strain Gauges YHF series

These gauges are developed for the measurement of very large strain up to 30~40%. These are not applicable to the measurement of repeated strain in elastic range as well as in large range.

Operating temperature range	-30~+80°C	Applicable adhesives
Strain limit in room-temperature	30~40%	CN -30~+80°C
		CN-Y -30~+80°C

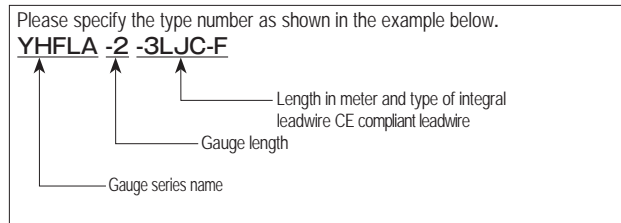

Gauge pattern	Type	Gauge size(mm)		Backing size(mm)		Resist-ance Ω
		Length	Width	Length	Width	
●Single axis						
YHFLA-2	YHFLA-2	2	1.5	8	2.7	120
YHFLA-5	YHFLA-5	5	1.7	11	3	120

Minimum order quantity is 10 strain gauges. These strain gauges are available with integral leadwires attached. (made to order)



# Post-yield Strain Gauges

## Dedicated leadwire recommended for YEF/YF/YHF series strain gauges

We supply various leadwires dedicated to strain gauges so as to meet our customers' requirements. Please refer to page 32 to 40 for the details of combination of a strain gauge and a leadwire.

### Type and designation of leadwires

Usage	Leadwire name	Operating temperature range of leadwire (°C)	Type number example
General purpose (without temperature change)	Paralleled vinyl LJC-F	-20 ~ +80	YEFLAB-2-3LJC-F YFLA-2-3LJC-F YHFLA-2-3LJC-F
General use	3-wire paralleled vinyl LJCT-F	-20 ~ +80	YEFLAB-2-3LJCT-F YFLA-2-3LJCT-F YHFLA-2-3LJCT-F



### Important point

#### ● Performance of YEF/YF/YHF

Series	Strain measurement	Fatigue limit at room temperature*1	Change of apparent strain due to cyclic loading of large strains*2	Self-temperature compensation	Applications
YEF	10~15%	$5 \times 10^5$ cycles	$2000 \times 10^{-6}$ strain/10 cycles	No	<ul style="list-style-type: none"> <li>Measurement of 10 to 15% elongation</li> <li>Measurement of repeated strain in elastic range.</li> </ul>
YF	15~20%	$1 \times 10^2$ cycles	$2000 \times 10^{-6}$ strain/10 cycles	No	<ul style="list-style-type: none"> <li>Measurement of 15 to 20% elongation</li> </ul>
YHF	30~40%	$2 \times 10^4$ cycles	N/A	No	<ul style="list-style-type: none"> <li>Measurement of 30 to 40% elongation</li> </ul>
F	5%	$1 \times 10^6$ cycles	$400 \times 10^{-6}$ strain/10 cycles	Yes	<ul style="list-style-type: none"> <li>Measurement of repeated strain in elastic range.</li> <li>Measurement of 5% elongation</li> </ul>

\*1: The number of repetitions at which the indicated strain value changes by  $100 \times 10^{-6}$  strain or more by applying repeated strain of approx.  $\pm 1,500 \times 10^{-6}$  strain at 15Hz

\*2: Change of indicated strain by applying a repeated strain of approx.  $\pm 10,000 \times 10^{-6}$  strain at a speed of 4 minutes per cycle.

#### ● Adhesive for YEF/YF/YHF series gauges

These strain gauges should be bonded with CN or CN-Y adhesive. If measurement is made a few days or longer after the strain gauge bonding, the CN-Y should be used. Measurement of large strain is possible even after one year of bonding the strain gauge with the CN-Y adhesive, provided that the specimens are stored at room temperature without any unfavorable conditions (moisture, direct sunlight, etc.).

#### ● CN adhesive variation with time

Though CN adhesive is normally used for large elongation strain measurement, the strain limit gradually decreases with the number of days following strain gauge installation. This variation with time occurs as a consequence of exposure to direct sunlight (UV), temperature and humidity, as well as the number of days after installation. The following shows an example of the results of testing performed by TML for the effects of adhesive variation with time. While these results show marked differences due to the exposure conditions of the test specimens (temperature and humidity), they also show that the strain limits for strain gauges decrease as time passes after installation. While this does not pose a problem in ordinary strain measurement, TML recommends that the measurement ends in 1 or 2 days after installation in the case of large elongation strain measurement. If the strain gauge is to be left for a long period after being installed, use the CN-Y adhesive.

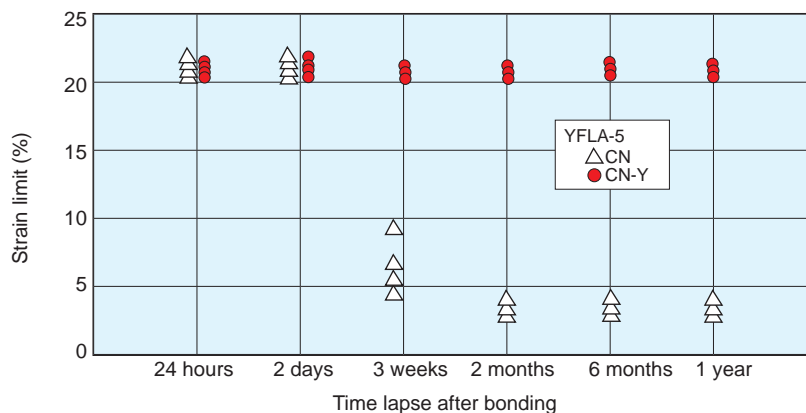

#### ● Countermeasure in case there is a span between gauge installation and start of measurement

Store the test specimen with the attached strain gauge in a cool, dark and dry location.  
Use the CN-Y adhesive. (Refer to the instructions provided).

#### ● Repeatability of Post-Yield strain gauges

Post-Yield strain gauges can be used once to measure large elongation strain, but cannot be used for measurement of repeated large elongation strain. When repeated testing is performed in a strain range exceeding  $5000 \times 10^{-6}$ , the strain gauge experiences zero drift. Note that the amount of drift varies depending on factors such as the type of strain gauges and the level and frequency of strain.





# High Endurance Strain Gauges DSF series

These gauges are designed for fatigue tests, and can reach a fatigue life of over 10 million times at a strain level of  $\pm 3000 \mu\epsilon$ . Compared to previously (1 million times at  $\pm 1500 \times 10^{-6}$  strain), these are gauges of exceptionally high durability. In aviation and other areas, repeated load tests of large elongation of composite materials are conducted. However, it had been necessary to adhere a new strain gauge frequently as a gauge reached its fatigue life. The DSF series greatly reduces time and cost of adhering gauges.

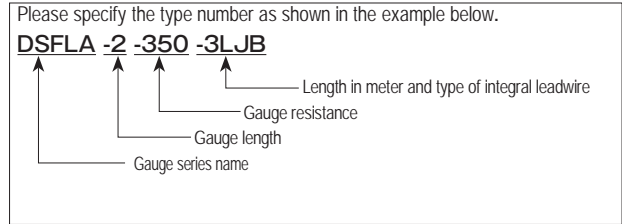
Operating temperature range -60~+200°C	Applicable adhesives
	CN -60~+120°C EB-2 / C-1 -60~+200°C



Gauge pattern	Type	Gauge size(mm)		Backing size(mm)			Resistance $\Omega$
		Length	Width	Length	Width	Thickness	
 DSFLA-2-350	DSFLA-2-350	2	2	8	3.3		350
 DSFLA-5-350	DSFLA-5-350	5	2	11	3.2		350

Example of strain gauge fatigue test results

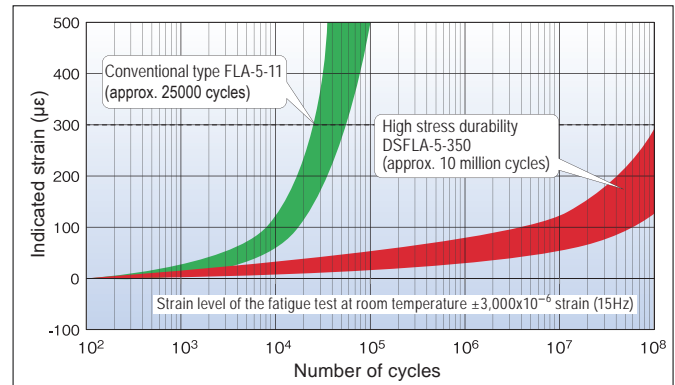

The strain gauge of this series is not self-temperature-compensated. It is recommended to measure the thermal output prior to the actual measurement using a dummy test piece made of the same material as the object to be measured.

**Fatigue Limit**  
This number is determined as the number of cycles in case a mechanically repeated strain of  $\pm 3000 \times 10^{-6}$  strain is applied to the strain gauge before the indicated strain changes by  $\pm 300 \times 10^{-6}$  strain.

Minimum order quantity is 10 strain gauges.  
These strain gauges are available with integral leadwires attached. (made to order)



# One-side Strain Gauges DD series

These gauges are intended for measuring the bending and tensile strains separately by simply bonding the gauges on one side of a plate or beam. It works on the assumption that the strain distribution in the section of the specimen is linear along the height of the section when the section is subjected to both tensile and bending stress. The gauges are effectively used for the measurement of a box construction in structures such as bridges or pressure vessels, where the reverse side of the measurement object is not accessible for strain gauge installation.

Operating temperature range -10~+70°C	Applicable adhesives
	CN -10~+70°C P-2 -10~+70°C

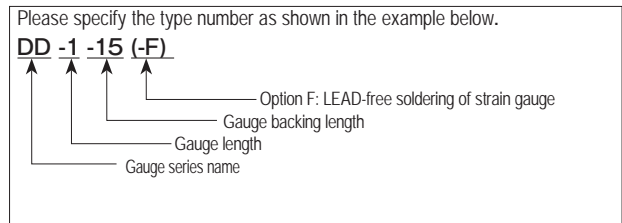

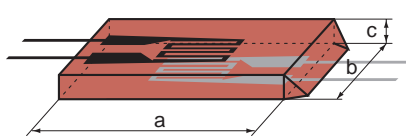
Gauge pattern	Thickness of applicable specimen (mm)	Type	Gauge size(mm)		Backing size(mm)			Resistance $\Omega$
			Length	Width	Length	Width	Thickness	
	Approx. 5 or less	DD-1-15	3	2.9	15	7	1	350
	Approx. 5 to 10	DD-2-30	3	2.9	30	7	2	350

These strain gauges are not self-temperature-compensated. It may be necessary to measure a thermal output using a dummy specimen prior to the measurement.  
Minimum order quantity is 5 strain gauges.



# Crack Detection Gauges FAC series $\text{C}\epsilon$

These gauges are designed to measure the propagation speed of fatigue crack in a metal specimen. The gauges are bonded with an adhesive on the position where the crack is initiated or the crack initiation is expected. The grids of the gauges, which are aligned at interval of 0.1mm or 0.5mm, are disconnected one by one with the propagation of the crack. The gauges are used together with the crack gauge adapter CGA-120B, and the disconnection of one grid is measured as the change of approx.  $45$  or  $40 \times 10^{-6}$  strain by a strainmeter.

Operating temperature range	-30~+80°C	Applicable adhesives	
		CN	-30~+80°C
		RP-2	-30~+80°C

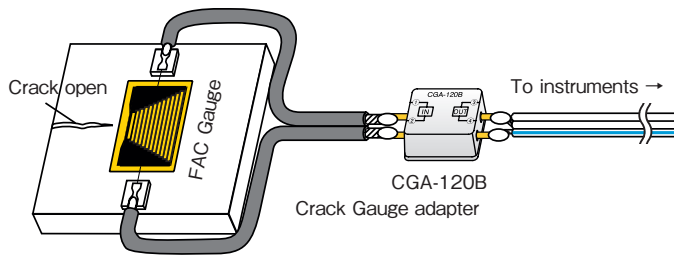

## CRACK GAUGES

Gauge type	FAC-5	FAC-20
Measuring range	4.5mm	20mm
Gauge resistance	approx. 1Ω	
Grid interval	0.1mm	0.5mm
Number of grids	46	41
Output per grid	approx. $45 \times 10^{-6}$ strain	approx. $40 \times 10^{-6}$ strain
Operating temperature	-30~+80°C	
Backing size	28 x 5mm	43 x 25mm

### ● Crack Gauges



FAC-5

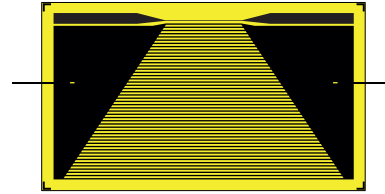

FAC-20

Minimum order quantity is 10 crack gauges.

### ● Crack Gauge adapter CGA-120B

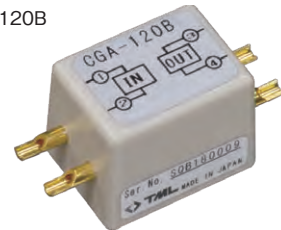

Minimum order quantity is 1 crack gauge adapter.

### Crack Gauge adapter CGA-120B

Measuring point	1 point
Allowable temperature	-30~+80°C
Bridge connection	Quarter bridge 3-wire method 120Ω
Dimensions	20(W) x 15(H) x 15(D) mm (except projection parts)
Weight	5g

• Option F: LEAD-free soldering

Example) Crack gauge FAC-5-F / FAC-20-F  
adapter CGA-120B-F



## AXIAL STRESS MEASUREMENT

# Stress Gauges SF series $\text{C}\epsilon$

These gauges are intended to measure the stress in an optional direction of the specimen in plane stress field. The gauges are sensitive not only in these axial direction but also in the transverse direction, and the sensitivity ratio of the transverse direction to the axial direction is equal to the Poisson's ratio of the specimen material. In addition, the gauges are not sensitive to the shearing strain. Accordingly, the output of the gauges is proportional to the stress in the axial direction. The gauges are available in three types depending on the Poisson's ratio of the specimen material.

Operating temperature range	-20~+200°C	Applicable adhesives	
Temperature compensation range	+10~+100°C	NP-50B	-20~+200°C
		C-1	-20~+200°C
		CN	-20~+120°C

Please specify the type number as shown in the example below.

**SFA-285-11-3LJC-F**

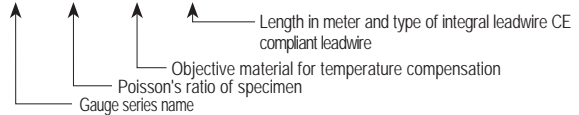

Objective material for temperature compensation (coefficient of linear thermal expansion  $\times 10^{-6}/^\circ\text{C}$ )

-11: Mild steel -17:Stainless steel -23:Aluminium

Note: The backing color of SF series gauges are the same for every material for temperature compensation.

Gauge pattern	Poisson's ratio of specimen	Type	Gauge size(mm)		Backing size(mm)		Resistance Ω
			Length	Width	Length	Width	
<b>● Single axis</b>  SFA-285	0.285	SFA-285-11					
 SFA-305-17 Q (×3)	0.305	SFA-305-17	4	3	9	6	120
	0.330	SFA-330-23					

Minimum order quantity is 10 strain gauges.  
These strain gauges are available with integral leadwires attached. (made to order)



# Temperature Gauges TF series

These gauges are bonded on the specimen surface like ordinary strain gauges, and measure the surface temperature. By combining with the dedicated temperature gauge adapter (TGA-1A or TGA-1B), actual temperature can be measured easily using a strainmeter.

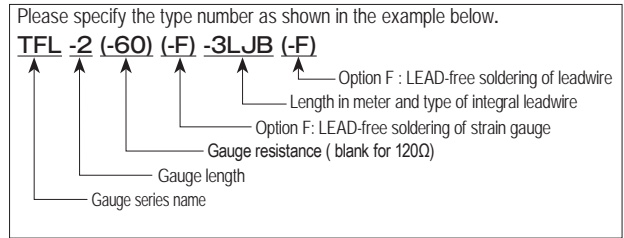

Operating temperature range -20~+200°C	Applicable adhesives NP-50B -20~+200°C C-1 -20~+200°C CN -20~+120°C
---	--

Gauge pattern	Type	Sensitivity (Ω/°C)	Gauge size(mm)		Backing size(mm)		Resistance Ω
			Length	Width	Length	Width	
TFL-2-60	TFL-2-60	0.34 approx.	2	1.9	6.1	3.5	60
TFL-3-60	TFL-3-60	0.34 approx.	3	3.2	8.5	5	60
TFL-6-60	TFL-6-60	0.34 approx.	6	2.6	12.4	4.5	60
TFL-8	TFL-8	0.68 approx.	8	3.5	14	5.5	120

Minimum order quantity is 10 gauges.  
These gauges are available with integral leadwires attached. (made to order)

## TGA-1A/TGA-1B Temperature Gauge Adapter

This adapter is used with temperature gauges TF series for direct reading of temperature with a strainmeter, and converts output to 100x10<sup>-6</sup> strain/°C.

Minimum order quantity is 1.

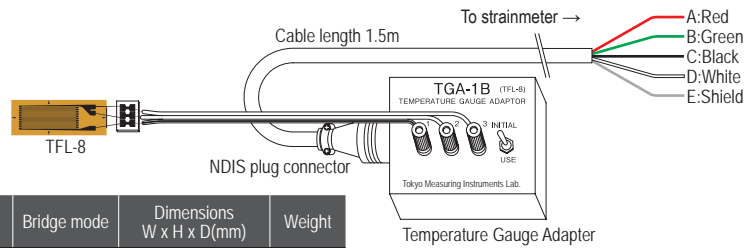

Type of adapter	Applicable gauge	Temperature °C	Sensitivity (x10 <sup>-6</sup> strain/°C)	Accuracy (°C)	Bridge mode	Dimensions W x H x D(mm)	Weight
TGA-1A	TFL-2-60 TFL-3-60 TFL-6-60	-20~+200	100	±1 or less	Full bridge	100×40×70	370g
TGA-1B	TFL-8	-20~+200	100	±1 or less	Full bridge	100×40×70	370g



# Platinum RTD / Thermocouple

## PLATINUM RTD

### PLATINUM RTD (Pt 100)

The Platinum RTD is mounted on a specimen and connected to a Data logger(TDS-630/-540/-150,TC-32K etc.) to measure temperature. Easy measurement of temperature by bonding to specimen with strain gauge adhesive. Units equipped with leadwire are also available upon request.

Type	Rated current	Base size (mm)	Resistance	Operating temperature
CRZ-2005	1mA or less	5.0x2.0x1.1	100Ω (at 0°C)	-40~+400 °C

Minimum order quantity is 10.

External dimensions

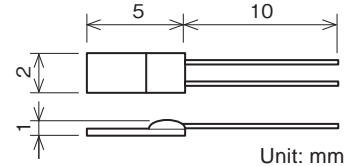

## THERMOCOUPLE

A thermocouple configures the closed circuit in which a small electric current flows in the circuit composed of a pair of dissimilar conductors,

and measures temperature using thermoelectric effect produced at both ends of conductors in different temperatures.

Type	Thermo-couple	Core diameter (mm)	Outer dimension (mm)	Sheath materials	Sheath color			Heat-resistive temperature (°C)	Length per roll (m)	Remarks
					Insulator	Outer sheath	+			
T-G-0.32	T	0.32	2.1x3.2	Heat-resistive vinyl	Red	White	Brown	approx.100	100	
T-G-0.65	T	0.65	2.6x4.0	Heat-resistive vinyl	Red	White	Brown	approx.100	100	
T-6F-0.32	T	0.32	1.0x1.6	Fluoroethylene propylene	Red	White	Brown	approx.200	100	
T-6F-0.65	T	0.65	1.5x2.5	Fluoroethylene propylene	Red	White	Brown	approx.200	100	
T-GS-0.65	T	0.65	Φ7.2	Heat-resistive vinyl	Red	White	Brown	approx.100	100	Shielded
K-H-0.32	K	0.32	1.4x2.3	Glass fiber	Red	White	Blue	approx.350	100	
K-H-0.65	K	0.65	2.0x3.4	Glass fiber	Red	White	Blue	approx.350	100	



# Bolt Strain Gauges BTM series $\text{C}\epsilon$

These gauges are used for measurement of tensile strain of bolt. They are simply inserted into pre-drilled hole in the bolt with exclusive adhesives. This method is recommendable when an ordinary strain gauges can not be mounted on the bolt surface. Accurate tensile force measurement is possible by calibrating the bolt after installing the bolt gauges.

The BTM bolt gauges use heat-curing A-2 adhesive for installation, which provides better long-term stability.

Operating temperature range  
-10~+80°C

Applicable adhesives  
A-2 -10~+80°C

Gauge pattern	Type	Gauge size(mm)		Backing size(mm)		Resistance $\Omega$
		Length	Width	Length	Width	

●Single axis

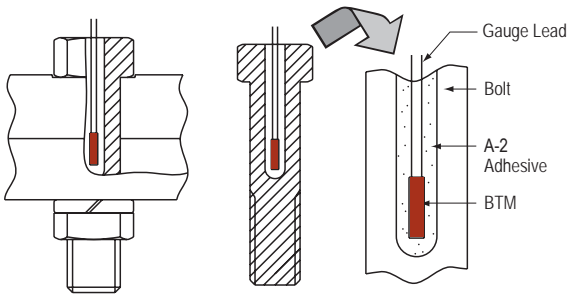
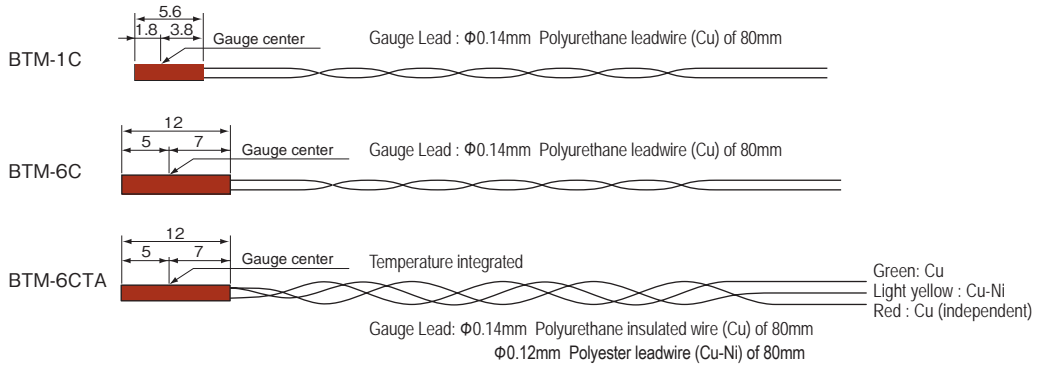

BTM-1C (Hole drilled : $\Phi 1.6\text{mm}$ )	1	0.7	5.6	1.4	120
BTM-6C (Hole drilled : $\Phi 2.0\text{mm}$ )	6	1	12	1.7	120
BTM-6CTA (Hole drilled : $\Phi 2.0\text{mm}$ )	6	1	12	1.7	120

Temperature integrated applicable in -10~+80°C

NB : Polyurethane insulation of the gauge leads is easily removed by heat of soldering iron, while Polyester sheath is removed by chemical solvent.

Minimum order quantity is 10 strain gauges.  
These strain gauges are available with integral leadwires attached. (made to order)

### Optional syringe and needle

Exclusive syringe for injecting A-2 adhesive into the pre-drilled hole before BTM gauge is embedded.

Applicable to	Needle diameter	Needle length
BTM-1C	1.5mm-dia.	60mm
BTM-6C	1.8mm-dia.	100mm







# Bolt Strain Gauges BTMC series CE

These gauges are used for measurement of tensile strain of bolt. They are simply inserted into pre-drilled hole in the bolt with exclusive adhesives. This method is recommendable when an ordinary strain gauges can not be mounted on the bolt surface. Accurate tensile force measurement is possible by calibrating the bolt after installing the bolt gauges.

The BTMC gauges have a tube shape sensing element, and they are installed with fast-curing CN adhesive. The installation is easily made at room temperature.

Operating temperature range  
-10~+80°C

Applicable adhesives  
CN -10~+80°C

Gauge pattern	Type	Gauge Length (mm)	Gauge Center a(mm)	Backing diameter $\phi b$ (mm)	Resistance $\Omega$
<p>●Single axis</p>	BTMC-05-D10-003LE (Hole drilled : $\phi 1.0\text{mm}$ )	0.5	5	$\phi 0.9$	120
	BTMC-1-D16-003LE (Hole drilled : $\phi 1.6\text{mm}$ )	1	5	$\phi 1.5$	120
	BTMC-3-D20-006LE (Hole drilled : $\phi 2.0\text{mm}$ )	3	10	$\phi 1.9$	120

Gauge Lead:  $\phi 0.1\text{mm}$  Polyimide insulated of 30mm for BTMC-05 and BTMC-1, 60mm for BTMC-3

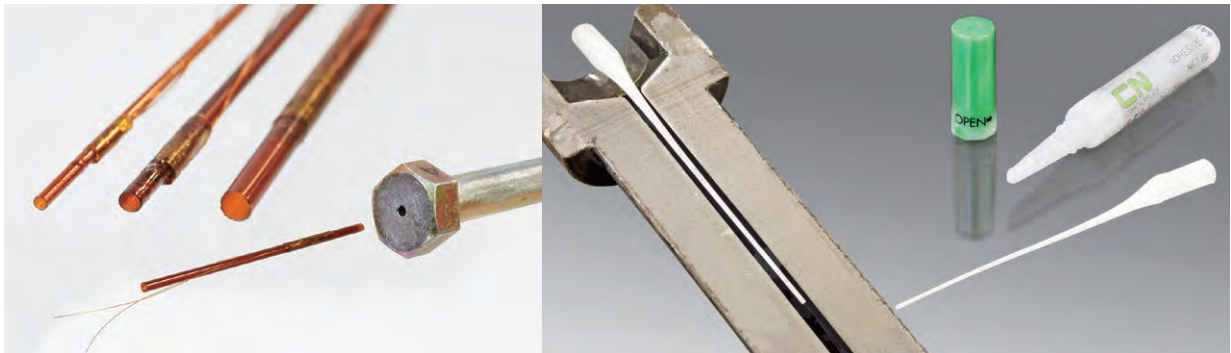



# Bolt strain gauge installation/calibration service

Currently, bolts are used in various fields for connecting structural members. Confirmation and management of the fixing condition are possible by measuring axial force applied to the bolt in machine structures, cars, airplanes, expressways, bridges, fixing of segments and so on. Also the axial force measurement is useful for knowing the strength of bolt and designing the bolt connection.

## Processing method

There are two methods in strain gauge installation service. One is embedding, and the other is bonding.

### Embedding BTM/BTMC series

A hole of 1.0mm, 1.6mm or 2mm in diameter is drilled in the center of the bolt. The strain gauge is inserted into the hole and embedded with an exclusive adhesive. This method has the advantage of avoiding the gauge being damaged by a washer, etc. while fastening the bolt.



TML offers strain gauging service for measurement of axial force acting on bolts. The service includes drilling a hole, fixing the gauge, connecting the cable, and applying load calibration to the bolt supplied by the customer. Strain gauge installation service for high temperature is also available.

### Bonding F, QF, ZF, CF series

Two strain gauges are bonded on both sides of the bolt shaft in axially symmetric positions to cancel the influence of bending. It is required to slightly scrape off the surface of the bolt shaft where the strain gauges are bonded, for the purpose of avoiding strain gauges being damaged while fastening the bolt or by contact of a washer. Choose strain gauges according to the usage conditions including temperature.



**Important point**

Embedment or installation service of strain gauges on bolts for high temperature use is available including the calibration work. Please contact us for the details.

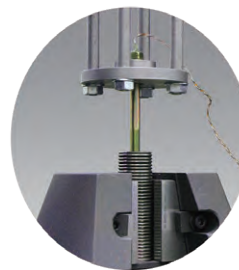

## Calibration service

In order to achieve accurate measurement, we offer calibration service in which the bolt is calibrated with specified load. Instruments and calibration machines used for the calibration service are periodically calibrated and inspected by public institutions traceable to the national standards.

Example)

Tensile test of bolt (bolt size : M10×1.25 L=65)

Load (KN)	0.0	4.6	9.2	13.8	18.4	23.0	Non-linearity (%RO)	Calibration coefficient (kN/1×10 <sup>-6</sup> )
Strain output (×10 <sup>-6</sup> )	0	378	747	1129	1518	1916	1.1	0.0120



# Transducer-specific strain gauge

TML strain gauges are used not only for the purpose of knowing strain/stress but also as sensors for strain gauge type transducers. A strain gauge type transducer converts physical quantity such as load, pressure or displacement into mechanical strain on the strain generating body (elastic body), and the mechanical strain is converted into electrical output using strain gauges mounted on the elastic body. We offer various types of transducer-specific strain gauges featuring highly reliable and stable performance.

- Force transducers (Load Cells)
- Pressure transducers
- Acceleration transducers
- Displacement transducers
- Torque transducers

## VARIOUS TYPES OF TML TRANSDUCER-SPECIFIC STRAIN GAUGES

### GAUGE PATTERN AND GAUGE LENGTH

Single, Rectangular 2-element, Torque (Shearing) strain measurement.

Pattern	Gauge length (mm)
Single axis	2, 3
0°/90° 2-axis	2, 3, 6
Torque measurement	2

#### Pattern

Single axis



(LA)

Torque

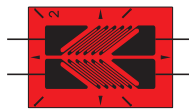

(CT)

0°/90° 2-axis

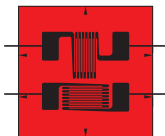

(CB)

0°/90° 2-axis



(CM)

2 types of 0°/90° 2-axis gauge are lined-up with different pattern of gauge tab. CM-type has half-bridge configuration.

### GAUGE RESISTANCE

Pattern	Gauge resistance (Ω)
Single axis	350, 1000
0°/90° 2-axis	120, 350
Torque measurement	350

Please note that 1000Ω gauge has less power consumption in bridge circuit comparing to 350Ω gauge's and limits Joule heat generation.

### GAUGE BACKING MATERIALS

Unlike stress measurement gauges, the gauge backing materials for transducer-specific strain gauge cannot be determined based solely on the operating temperature and bonding method. To ensure maximum transducer performance, it is necessary to test various combinations using different stress-generating bodies (elastic bodies) to select the most suitable backing materials.

#### OPERATING TEMPERATURE

Operating temperature range differs from heat-resistive temperature. F series gauge (with epoxy backing) is also available for use of heat-curing type bonding adhesives. Refer to pages 89 and 90 for the details.

Gauge series	Gauge backing materials	Operating temperature
F	Special plastic resin	-20~+80°C
QF	Polyimide resin	-20~+200°C
EF	Polyimide resin	-20~+200°C

### TEMPERATURE COMPENSATION

Similarly as general purpose strain gauges, self-temperature-compensated gauges are available in three types for mild steel, stainless steel and aluminium. Better temperature compensation is available by configuring a bridge circuit using self-temperature-compensated strain gauges. More precise temperature compensation is achieved by adding a resistor for zero point compensation in the bridge circuit.

Note) EF series gauges are self-temperature-compensated for mild steel only.

Gauge series	Self-temperature-compensation materials (Linear thermal expansion coefficient in ppm/°C)
F	<span style="color:red">■</span> -11: Mild steel
	<span style="color:orange">■</span> -17: Stainless steel
	<span style="color:green">■</span> -23: Aluminium

### CREEP ADJUSTMENT

The creep characteristic is particularly important in force transducers. The most common compensation system uses the material creep (+) of the stress-generating body (elastic body) and the gauge creep (-) to cancel each other. Various TML strain gauges are available for creep adjustment and are selectable by creep code.

#### Creep code

Gauge creep	Large $\longrightarrow$ Small
Creep code	C2 > C4 > C6 > C8

### TEMPERATURE SENSITIVITY COMPENSATION

Elastic modulus of strain-generating body (elastic body) varies with temperature. In the same manner, as ambient temperature around the strain-generating body varies, it results in a change of measured strain under loaded condition. To reduce such temperature influence, sensitivity compensation resistor is assembled in bridge circuit.

#### Coding system of Transducer-specific strain gauges

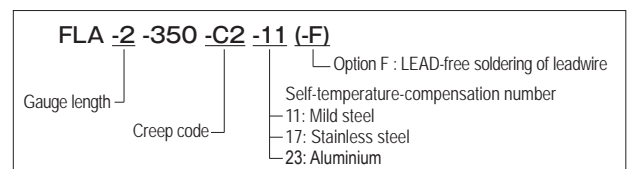



# Frictional Strain Checker FGMH series

No bonding is required for strain measurement on steel

## Features

- Easy mounting and detaching by lever operation
- Paint removal, grinding, bonding and curing are not necessary
- Can be used repeatedly
- Strain measurement in three directions (FGMH-3A)

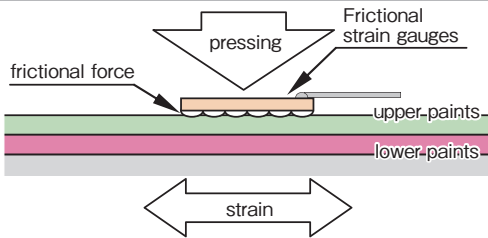

The Strain checker FGMH series measures strain using frictional force working on the contact surface of the frictional strain gauge by pressing the gauge against the structure with magnetic force. Unlike bondable strain gauges, surface preparation and bonding works are not required for this gauge, thus the works required for strain measurement are largely reduced. In combined use with a handheld type strainmeter, the strain checker



can easily measure strains on steel materials such as bridges by changing measurement point one after another. It is the most suited to preparatory measurements before starting a long term measurement.

In the FGMH series, three types are available. They are FGMH-1B and FGMH-2A both for single axis measurement and FGMH-3A for 0°/45°/90° three-axis measurement.

## FGMH-1B (Single axis measurement)

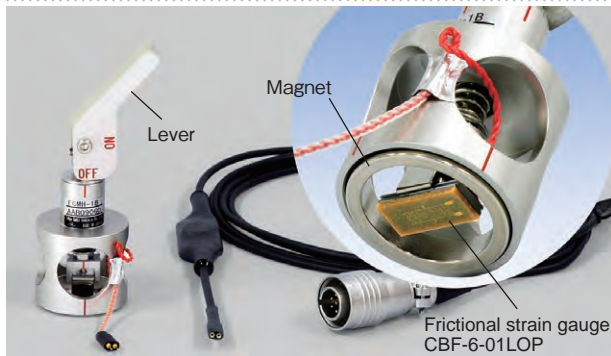

The FGMH-1B is a strain checker constructed small and light. The frictional strain gauge is set to on, off and replacing position by the operation of lever, thus allowing easy handling of the strain checker.

## FGMH-2A (Single axis measurement)

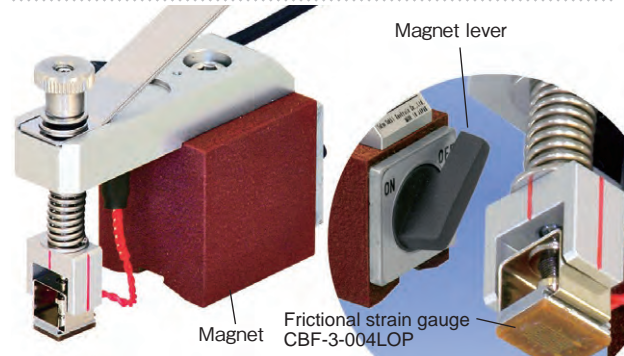

The FGMH-2A is a strain checker especially designed for measurement on a small area such as the vicinity of a welded part. It can be easily attached to and detached from measurement object by the operation of magnet lever. In addition, a lever is provided on the upper part to slightly lift the frictional strain gauge from the measurement surface by pushing the lever downward. It enables easy adjustment of the direction of the strain gauge.

## FGMH-3A (Three-axis measurement 0°/45°/90°)

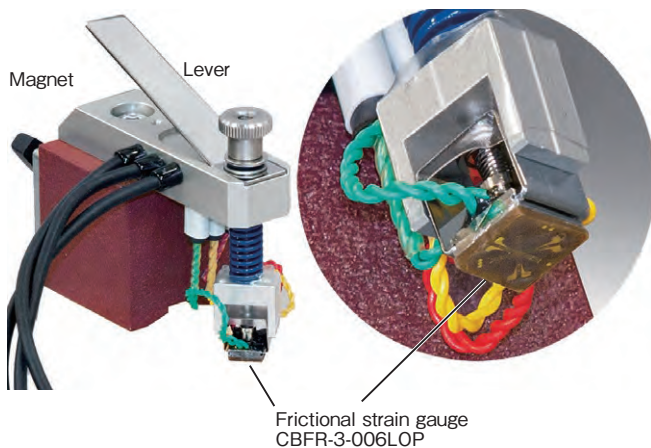

The FGMH-3A is a strain checker for three-axis measurement in 0°/45°/90°. Principal stress (principal strain) and its direction can be found by applying rosette analysis calculation to the measured strain values in three directions. It is applicable to measurement in the vicinity of weld bead like as the FGMH-2A. Also similarly as the FGMH-2A, it can be easily attached to and detached from a measurement object by the operation of strain gauge. Another lever is provided for easy adjustment of the direction of the strain gauge.

The frictional strain gauge is a consumable part. If it is stained, deteriorated or damaged, replace it with a new one.

### Option : Applicable frictional strain gauge

Type	Applicable frictional strain gauge (CE compliant)
FGMH-1B	CBF-6B-01LJAP-F
FGMH-2A	CBF-3B-004LJAP-F
FGMH-3A	CBFR-3B-006LJAP-F

### Application examples

- Preparatory measurement of bridge which will undergo a long term measurement
- Investigation of neutral axis position of composite girder bridge
- Stress direction of structural member of bridge on which fatigue crack is initiated
- Stress measurement of newly built bridge where paint removal is not available.

### Strain measurement in a narrow area

Stress concentration is caused in the vicinity of weld bead, which is deposit of welded materials along the welding pass. The strain checker FGMH-2A/FGMH-3A is capable of strain measurement in a narrow area such as the vicinity of weld bead because it is easily attached and detached by ON/OFF operation of the magnet lever. Strain in three directions can be measured simultaneously by the use of FGMH-3A.

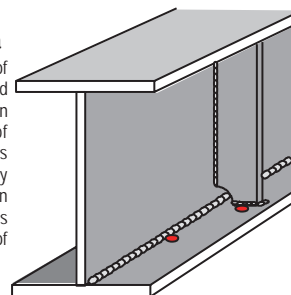

### Specifications

Type	FGMH-1B	FGMH-2A	FGMH-3A
Number of axes	Single axis		Three-axis
Gauge length	6mm	3mm	
Operating temperature	0 ~ +60°C		
Compensated temperature range	0 ~ +60°C		
Objective material	Metal, Steel (Coefficient of thermal expansion 11ppm/°C)		
Gauge factor	Approx. 2.00		
Input/Output resistance	120Ω		
Measurement mode	Full bridge		
Input/Output cable	—	Φ3mm 0.05mm <sup>2</sup> 4-core shielded chloroprene cable of 2m NDIS 7-pin plug attached	
Supplied cable	Leadwire with bridge circuit board 2m, NDIS 7-pin plug attached	—	
Weight (excluding cable)	Approx. 60 g	Approx. 260g	

#### Note:

- The strain checker is installed on a measurement object by magnetic force. It is not applicable to measurement on non-magnetic materials.
- The strain checker is not applicable to the use on a curved or uneven surface.
- If the vicinity of the strain checker is hit strongly with a hammer or equivalent, a shift in the measured value may be caused.
- Correct measurement may not be possible by the strain checker on a machine or structure experiencing strong vibration.
- For more precise measurement, it is recommended to remove the paint and to bond an ordinary strain gauge on the base metal surface.

### Dimensions

#### FGMH-1B (Single axis)

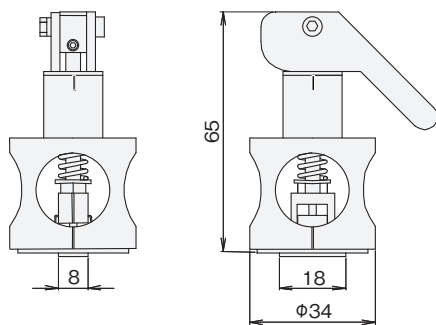

#### FGMH-2A (Single axis)

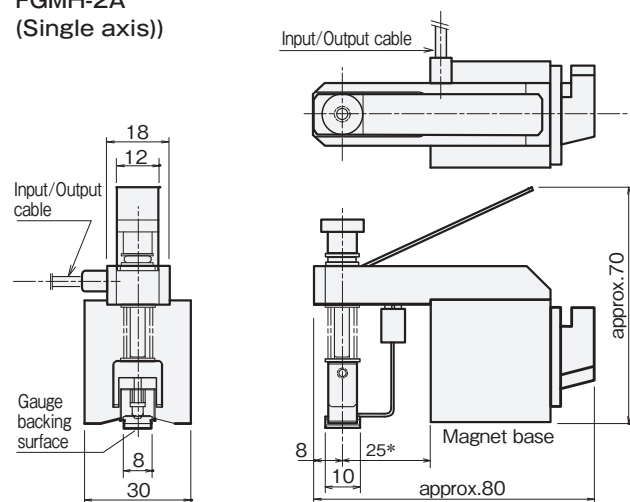

#### FGMH-3A(0°/45°/90° Three-axis)

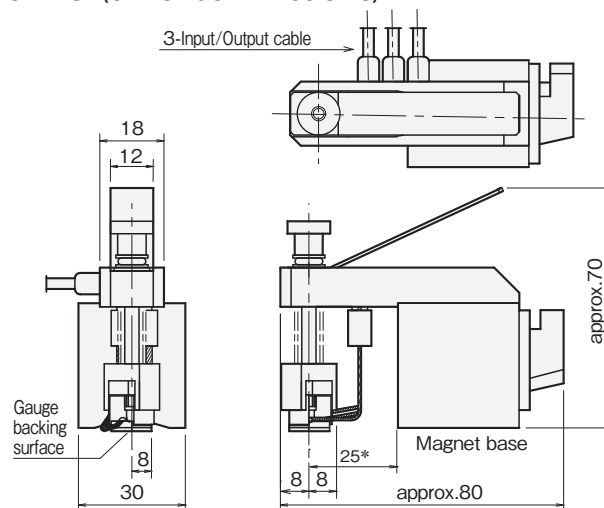

\*: Where the gauge backing surface is in parallel with the magnet base. (FGMH-2A, FGMH-3A)

Unit : mm



# Frictional Axial Strain Transducer FGAH-1B



**Applicable not only for tie-rod of motor cars but also for tension rod of architectural structures**

## Features

- Easily installed by just clamping-on without detaching the existing tie-rod
- Tensile force management of rod between sheet piles or in architectural structures is easily achieved – The transducer can be used repeatedly
- Applicable rod:  
FGAH-1B-R : Diameter is 10 to 25mm  
FGAH-1B-H : Width cross flats 10 to 25mm  
(Optional spacers are required)
- Small and light construction which allows installation in a narrow space

## Dimensions

### FGAH-1B-R

Shaft (Rod)  $\Phi 10 \sim 25\text{mm}$   
adjustable by 0.1mm step

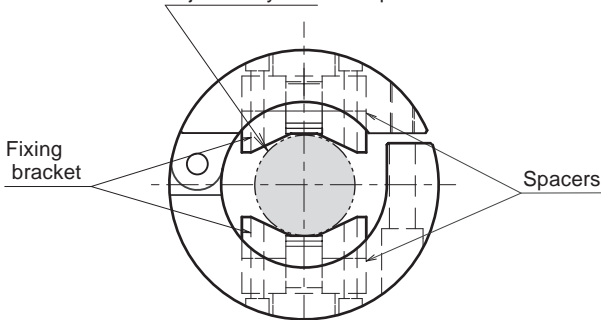

### FGAH-1B-H

Width across flats  
10~25mm adjustable  
by 0.1mm step

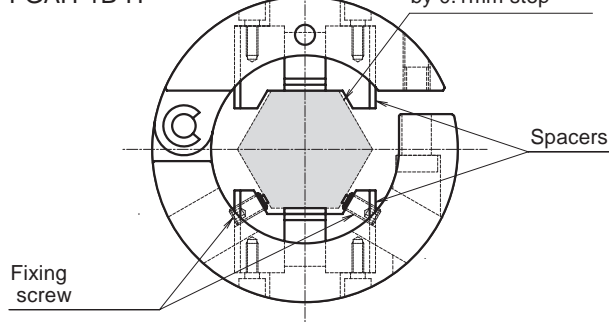

Unit : mm

This transducer measures axial strain of steering tie-rod of a car and consists of two types FGAH-1B-R and FGAH-1B-H for which a cross section of the rod is round shape or hexagon's. It is also suited to measure axial strain of a tension rod used in aseismic reinforcement structure or in steel frame structure. Since frictional strain gauges are used in this transducer, installation is completed and it gets ready for measurement by merely pinching the rod with the transducer, without detaching the rod. There is no need of technical skill and complicated works for attaching strain gauges on the rod.

NB:

- Frictional strain gauges are consumable parts.  
Applicable type of frictional strain gauges is CBFC-2 (option).

## Specifications

Type	FGAH-1B-R	FGAH-1B-H
Applicable shaft	Round shape $\Phi 10 \sim 25\text{mm}$	Hexagon shape Width across flats 10~25mm
Capacity	$\pm 1000 \times 10^{-6}$ strain	
Rated output	Approx. $2600 \times 10^{-6}$ strain	
Non-linearity	1%RO	
Allowable temperature range	$-30 \sim +60^\circ\text{C}$ (no dew condensation)	
Frequency response	Approx. 6.5kHz	
Input/output resistance	$1000\Omega \pm 3\%$	
Dimensions	Approx. $\Phi 52 \times 35\text{mm}$	
Weight	Approx. 55g(excluding spacers and cable)	
Protection rating	Equivalent to IP51	
Recommended exciting voltage	2V	
Allowable exciting voltage	5V	
Input/output cable	$\Phi 3.2\text{mm}$ 0.08mm <sup>2</sup> 4-core shielded vinyl cable 5m	

## Installation image

Installation on tension rod of  
aseismic reinforcement structure



Turnbuckle part



Installation on steering tie-rod of a car





# Frictional Torque Sensor System FGDH-3A



Torque Sensor System measures torque on the drive shaft of a car. Frictional strain gauges are used as sensing elements, and installation is completed by clamping the torque sensor system onto an existing shaft and securing it with a screw. There is no need of detaching the shaft, bonding nor wiring strain gauges for installation. Applicable shaft diameters are  $\phi 20$  to 30 mm,  $\phi 30$  to 40 mm, and  $\phi 40$  to 50 mm. A digital telemetry transmitter is built in the sensor, and measured data are transmitted to an exclusive receiver DT-182R by wireless and output as analog signals. For wireless transmission, 2.4GHz band advanced low power data communication system is used. Power supply uses a USB power cable with recharging capability, so the sensor can be recharged without needing to be removed.

[Patent registered]

## Features

- Easily installed by just clamping-on without detaching the drive shaft
- Three types available for applicable shaft diameter of 20~30, 30~40 and 40~50 mm
- No bonding is required because frictional strain gauges are used
- Globally standardized 2.4GHz band data communication system is used for noise resistant digital transmission
- Battery is rechargeable with the FGDH installed on the shaft
- Power saving function provided

## Specifications (Toque transducer)

Type	FGDH-3A	FGDH-3A-30/40	FGDH-3A-40/50
Applicable shaft diameter	$\phi 20.0 \sim 30.0\text{mm}$	$\phi 30.0 \sim 40.0\text{mm}$	$\phi 40.0 \sim 50.0\text{mm}$
Capacity	Depends on the diameter (outer/inner) and material of the shaft		
Output	Depends on the diameter (outer/inner) and material of the shaft However, within $\pm 16000 \times 10^{-6}$ strain including initial unbalance of $\pm 2000 \times 10^{-6}$ strain		
Non-linearity	1%RO		
Allowable temperature	$-20 \sim +60^\circ\text{C}$ (no dew condensation)		
Sampling frequency	5kHz		
Frequency response	1kHz		
Wireless specifications	Conforms to 2.4GHz band advanced low power data communication system		
Number of wireless channels	16		
Dimensions	$\phi 52 \times 50\text{mm}$	$\phi 64 \times 50\text{mm}$	$\phi 75 \times 50\text{mm}$
Weight (excluding spacer)	Approx. 85g	Approx. 130g	Approx. 160g
Protection rating	Equivalent to IP51		
Continuous operating time	Approx. 6 hours (23 $\pm$ 5 $^\circ\text{C}$ )		
Power source	Lithium-ion secondary battery		
Accessory	USB charger		

NB:

- This system is approved for use in Japan, the EU member countries, the People's Republic of China. Please contact us for other countries.
- This system may not be applicable depending on the material, surface roughness or surface treatment of the shaft. Please contact us beforehand.
- Frictional strain gauges are consumable parts. Applicable type of frictional strain gauge is CBFTC-2-005CT. (option).
- A torque driver is required for the installation of FGDH-3A

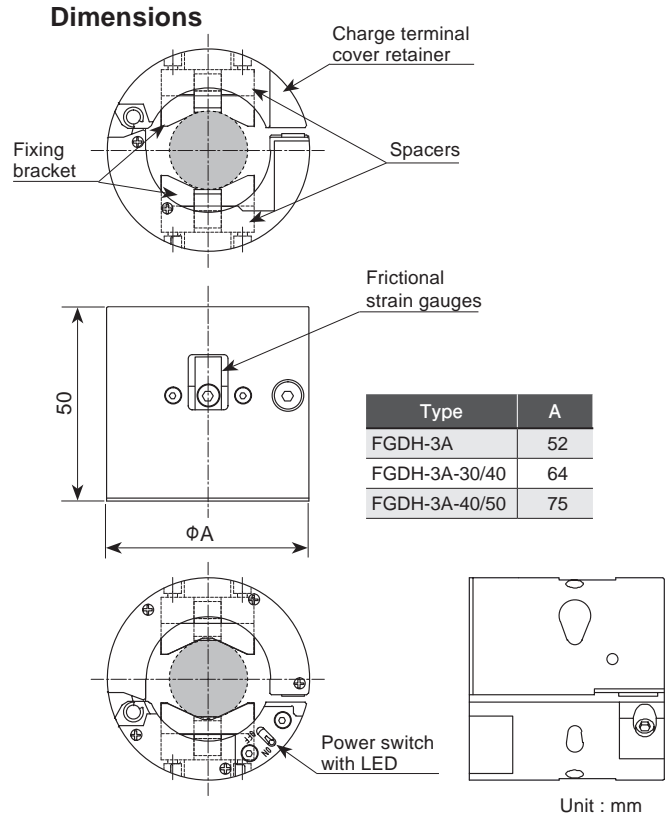

## Specifications (Receiver)

Type	DT-182R
[ Wireless part ]	
Number of receptions	1
Wireless specifications	Conforms to 2.4GHz band advanced low power data communication system
Number of wireless channels	16 channels (Set by wave channel switch)
Antenna connecting terminal	SMA connector
[ Voltage output part ]	
Number of voltage outputs	1 of either received strain value or transmitter battery voltage (BNC)
Strain measurement	$\pm 5\text{V FS}$ (at $\pm 16000 \times 10^{-6}$ strain input, 5k $\Omega$ load)
Transmitter battery voltage measurement	+1.3 ~ +3.9V (5k $\Omega$ load)
Voltage output accuracy	$\pm 0.5\% \text{FS}$ (Entire system)
Stability on zero	$\pm 0.55\text{mV}/^\circ\text{C}$ (Entire system)
Stability on sensitivity	$\pm 0.05\% \text{FS}/^\circ\text{C}$ (Entire system)
SN ratio	47dB
Calibration output level	$\pm 5\text{V}$
Low-pass filter	100Hz, 500Hz, PASS(1kHz)(-3dB $\pm$ 1dB)
Balancing range	$\pm 6000 \times 10^{-6}$ strain
Balancing accuracy	$\pm 5\text{mV}$
Display/Operation	LED for output level, Low-pass filter selection switch, Calibration output selection switch, Balancing switch
[ General Specifications ]	
Power source voltage	DC9~16V
Current consumption	80mA Max. (when DC12V is supplied at +23 $^\circ\text{C}$ $\pm$ 5 $^\circ\text{C}$ )
Connector	HOSHIDEN HEC3800 (Compatible plug : $\phi 5.5 \times 3.3$ PIN $\phi 1\text{mm}$ )
Operating environment	0 ~ +50 $^\circ\text{C}$ , 85%RH or less (no dew condensation)
External dimensions	48(W) x 23.5(H) x 100(D) mm (except projecting parts)
Weight	Approx. 140g
Standard accessory	BNC coaxial cable (CR-31) DC power cable (CR-062) Receiving antenna (AA2402RSPU) USB charger (FGDHF-52) USB cable (mini-B - A)(CR-6187)

NB:

- Coaxial cable for the extension of receiving antenna is required.  
C3RSPJ-EXT-1M (1m long), C3RSPJ-EXT-3M (3m long), C3RSPJ-EXT-5M (5m long)



# Residual stress measurement

Residual stress, which is caused in structural parts by heat treatment, welding or loading of the parts, lowers the strength and fatigue strength of the structures because the residual stress is added to the actual load even if the actual load is within the allowable range. Evaluation of residual stress is an important factor for improving the machining accuracy, evaluating the integrity and diagnosing the surplus life of the structural parts.

Residual stress measurement using a strain gauge has the advantage of

directly measuring strain as nominal stress value. However, it is difficult to know residual stress in general strain measurement. There are two methods for measuring residual stress using strain gauges. One is a partial release method (mainly drilling method) to release the residual stress locally by making a slit or hole in the vicinity of the strain gauge. Another is a full release method (mainly cutting method) to release the residual stress by cutting around the strain gauge by machining. We supply strain gauges dedicated to residual stress measurement.

## Method using partial release

This method is applied when a slight mechanical destruction (semi-destruction) is allowed for the specimen even though it cannot be fully destroyed. A hole of approximately 2 mm in diameter and 3 mm in depth will be made. A strain gauge dedicated to residual stress measurement is bonded on the measurement position and a hole is drilled in the center of the strain gauge. Partial release strain generated by the drilling is

measured, and residual stress is calculated using the strain and parameters such as drilling diameter and elastic modulus and Poisson's ratio of the specimen. Since the hole must be drilled exactly in the center of the strain gauge, and strain by machining must not be induced, dedicated tools and drilling apparatus are used.

## Residual stress measurement using drilling method

In the partial release method using FRS strain gauge, residual stress is calculated from the partially released strain generated by drilling a small hole on the specimen. This method is introduced in ASTM Standard E837 (Determining Residual Stress by the Hole-Drilling Strain Gauge Method).

Applicable strain gauge	FRS-2 (gauge length : 1.5mm) FRAS-2 (gauge length : 2mm)
Operating temperature range	-196 ~ +150°C
Temperature compensation range	+10 ~ +100°C
Applicable adhesives	CN

Please refer to page 45, 89 and 90 for the detailed specifications.

## Strain gauges for residual stress measurement by hole drilling method

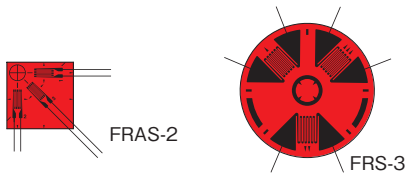

Type	Gauge size(mm)		Backing size(mm)		Gauge center diameter (mm)	Resistance (Ω)
	Length	Width	Length	Width		
FRAS-2	2	1.1	9	9	φ7.0	120
FRS-2	1.5	1.3	φ9.5		φ5.14	120
FRS-3	3	2.6	φ17.5		φ10.26	120

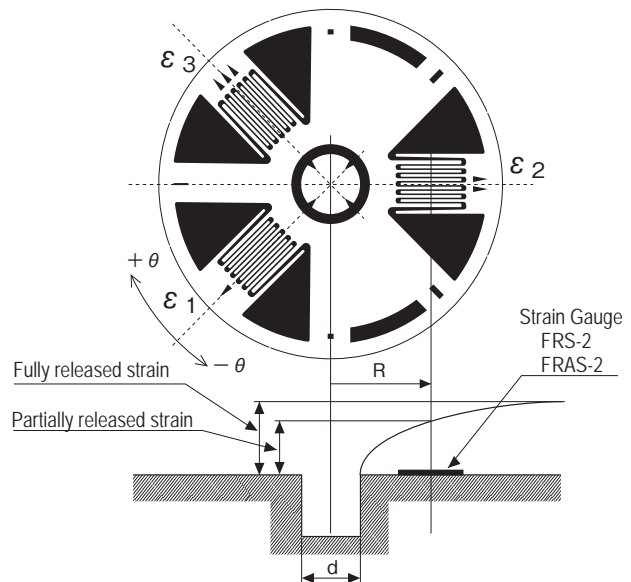

## Maximum residual stress

$$\sigma_{\max} = \frac{\varepsilon_1 + \varepsilon_3}{4A} + \frac{\varepsilon_1 - \varepsilon_3}{4B \cos 2\theta}$$

## Minimum residual stress

$$\sigma_{\min} = \frac{\varepsilon_1 + \varepsilon_3}{4A} - \frac{\varepsilon_1 - \varepsilon_3}{4B \cos 2\theta}$$

Angle from  $\varepsilon_1$  axis to the direction of Maximum residual stress (positive (+) for clockwise direction from  $\varepsilon_1$  axis)

$$\theta = \frac{1}{2} \tan^{-1} \frac{\varepsilon_1 + \varepsilon_3 - 2\varepsilon_2}{\varepsilon_3 - \varepsilon_1}$$

Here, A and B are constants determined by the drilled hole diameter and the gauge center radius.

$$4A = -\frac{(1+\nu)d^2}{2ER^2} \quad 4B = -\frac{2d^2}{ER^2} + \frac{3(1+\nu)d^4}{8ER^4}$$

$\nu$  : Poisson's ratio  
 $d$  : Drilled hole diameter  
 $\varepsilon_1 \sim \varepsilon_3$  : Measured strain  
 $R$  : Gauge center radius  
 $E$  : Young's modulus



## Method using full release

When the specimen is allowed to be destroyed, a strain gauge is bonded on the measurement position and whole circumference of the position is cut to fully release the residual stress. The residual stress is calculated by stress analysis using the change of strain resulted from the cutting.

### Residual stress measurement using cutting method

Strain gauge to be used is selected from single-axis gauge, 2-axis gauge, 3-axis gauge and stress concentration measurement gauge according to the condition.

Also in the full release method, care must be taken not to allow any strain by machining is induced and not to damage the strain gauge during the cutting.

As the cutting method, cutting grinder with a thin cutter or electrical discharge machining is utilized. These methods cause little machining stress.

Generally, measurement is made using a data logger (static strain meter).

A strain gauge is installed on the measurement position, and initial unbalance value is measured. If the strain gauge and its wiring are exposed to cutting fluid, protective coatings are applied, or the leadwire is once detached and only the strain gauge part is coated before the cutting process. Cut the specimen so as not to induce machining stress. If temperature change is caused by the cutting, carry out measurement after the temperature returns to normal.

Use the same channel of the same instrument for measurements before and after the cutting. This is because initial unbalance values are not consistent for different channels or instruments.

Applicable strain gauge	FR-5 (gauge length : 5mm 3-axis) EUBC-06 (gauge length : 0.6mm 2-axis) FCV-1 (gauge length : 1mm 2-axis × 5 paralleled)
Operating temperature range	-196 ~+150°C
Temperature compensation range	+10 ~+100°C
Applicable adhesives	CN

Please refer to page 45, 46, 89 and 90 for the detailed specifications.

### For residual stress measurement

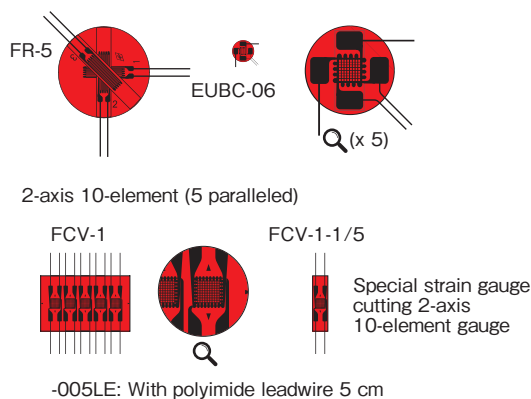

Weld bead (rosette strain gauge)

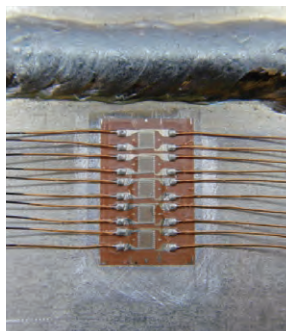

Weld bead (strain gauge for stress concentration)

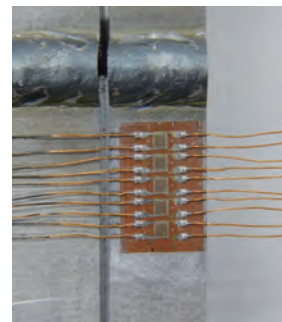

After cutting and releasing



# Strain Gauge Adhesives



Type	Contents	Component	Applicable specimen	Operating temperature	Curing temperature and time	Shelf life	
CN	Single component Room-temperature-curing	Single 2g x 5	Cyanoacrylate	Metal, Plastics Composite	-196~+120°C	Room temperature 20sec.~1 min. (thumb pressure)	6 months
CN-E	Single component Room-temperature-curing	Single 2g x 5	Cyanoacrylate	Concrete Mortar, Wood	-30~+120°C	Room temperature 40sec.~2 min. (thumb pressure)	6 months
CN-R	Single component Room-temperature-curing	Single 2g x 5	Cyanoacrylate	Metal, Plastics Composite	-30~+120°C	Room temperature 10~30sec. (thumb pressure)	3 months
CN-Y	Single component Room-temperature-curing	Single 2g x 5	Cyanoacrylate	Metal, Plastics Composite	-30~+80°C	Room temperature 60 sec.~2 min. (thumb pressure)	6 months
P-2	Two-component Room-temperature-curing Mixing ratio: 2~6%	A: 25g * B: 3g *	Polyester	Metal	-30~+180°C	Room temperature Pressure 50~300kPa 2~3 hrs.	6 months
RP-2	Two-component Room-temperature-curing Mixing ratio: 2~4%	A: 25g * B: 3g *	Polyester	Concrete Mortar	-30~+180°C	Room temperature Pressure 50~300kPa 2~3 hrs.	3 months
PS	Two-component Room-temperature-curing Mixing ratio: 2~4%	A: 25g * B: 3g *	Polyester	Concrete Mortar Wood	-30~+100°C	Room temperature 2~3 hrs.	3 months
NP-50B	Two-component Room-temperature-curing Mixing ratio: 3~4%	A: 25g * B: 3g *	Polyester	Metal Composite	-30~+300°C	Room temperature Pressure 50~300kPa 16 hrs.	6 months
C-1	Single component Heat-curing	Single 25g *	Phenol	Metal	-269~+200°C	Pre-curing at 130°C 1 hr., pressure 200~300kPa. Post-curing at 200°C 1 hr. without pressure	3 months
EA-2A	Two-component Room-temperature-curing Mixing ratio: 2:1	A: 25g * B: 15g *	Epoxy	Metal, Concrete Composite	-269~+50°C	Pressure at 50~300kPa. Room temperature 1 day, or at 50°C 2 hrs.	3 months
EB-2	Two-component Room-temperature-curing Mixing ratio: 10: 3	A: 10g x3 B: 3g x3	Epoxy	Metal Composite	-60~+200°C	Room temperature 1 day Pressure 50~200kPa.	3 months
A-2	Two-component Heat-curing Mixing ratio: 10: 1	A: 25g * B: 5g *	Epoxy	Bolt	-30~+100°C	Room temperature 12 hrs. and 140°C 3 hrs.	3 months

### NB: Shelf life

Effective storing duration on condition that the adhesive is properly kept in a cool, dry and dark place such as a refrigerator (+5~+10°C, do not store in a freezer).

Thumb pressure 100~300kPa

### SDS : Safety Data Sheet

TML supplies SDS for all its strain gauge adhesives and coatings. Contact your TML supplier for more information.

For two-component adhesives, use the supplied mixing vessels.

Mixing vessels: Polyethylene make  
75mm-diameter, 10mm depth

\* : These contents are for outside Japan.



PS

NP-50B

C-1

EA-2A

EB-2

A-2

## Applications

Single component adhesive for strain gauges. The time required to bond the gauge is extremely short and handling is very easy. The thin bonding layer allows adhesion to plastic objects as well as metal.

Measurement of large strain (post-yield measurement) is possible until the next day of bonding of the strain gauge.

Note) Use protective eyewear when using this adhesive.

Single component adhesive featuring high viscosity for bonding strain gauges to porous materials such as concrete and mortar.

Note) Use protective eyewear when using this adhesive.

Single component adhesive for accelerating cures in lower ambient temperature, or lower relative humidity.

Note) This adhesive is sold only for a limited time. (from October to the next April)

Note) Use protective eyewear when using this adhesive.

Single component adhesive designed exclusively for use on post-yield strain gauge. Offers minimum degradation in bonding performance (peel strength) due to aging. Suitable when a large strain measurement is made after a few days or more of bonding the strain gauge.

Measurement of large strain (post-yield measurement) is possible even after one year of bonding.

Note) Use protective eyewear when using this adhesive.

Two-component room-temperature-curing polyester adhesive for bonding PF, P and F series strain gauges. Put the necessary quantity of drug A in the supplied mixing vessel, then add drug B by drops to total 2~6% in weight of drug A. Use the mixed adhesive within 10~20 minutes.

Two-component room-temperature-curing polyester adhesive for bonding PF and P series strain gauges. The mixing procedure is the same as above for P-2 adhesive. Put the necessary quantity of drug A in the supplied mixing vessel, then add drug B by drops to total 2~4% by weight of drug A. Use the mixed adhesive within 10~20 minutes.

Two-component room-temperature-curing polyester adhesive. Use as a surface precoating agent for bonding P and PF series gauges to concrete and also as an adhesive for WFLM series gauges. The special filler contained exhibits alkali resistance and effectively shuts off moisture and gas from inside of the concrete. Its high viscosity enables use on vertical walls or ceilings.

Two-component room-temperature-curing polyester adhesive for bonding QF, ZF and BF series strain gauges. Put the necessary quantity of drug A into the supplied mixing vessel then add drug B by drops to total 3~4% by weight of drug A. Use the mixed adhesive within 5~20 minutes.

Single-component heat-curing type adhesive. For use on strain gauges that are suited to heat curing. Enables reliable measurement for long periods and in high temperature up to 200°C.

Two-component room-temperature-curing epoxy adhesive for bonding CF series strain gauges for use in temperature from cryogenic (-269°C) up to 50°C.

Two-component room-temperature-curing epoxy adhesive for bonding strain gauges for use in temperature from -60 to +200°C. Enables stable measurement for a long period of time.

Two-component heat-curing epoxy adhesive for bonding BTM strain gauges.



## Important point

- In general, curing time of an adhesive called "room temperature curing type" is largely affected by environmental conditions such as temperature and humidity. Referring to the curing conditions described in the supplied operation manual, it is recommended to carry out a "test curing" on the site.
- A trace of water in the air is required to cure the CN adhesive (cyanoacrylate). Therefore the curing time is largely affected by humidity rather than temperature.



# Coating Materials

The type of coating required and the application method differ depending on the environment in which the strain gauge is used. In general, if one type of coating is not sufficient, multiple coatings can be combined to protect the strain gauges. At TML, the coating applied directly to the surface of the strain gauge is referred to as the first coating with subsequent coating layers referred to sequentially as the second coating, third coating, etc. Multi-layer coatings offer better strain gauge protection.

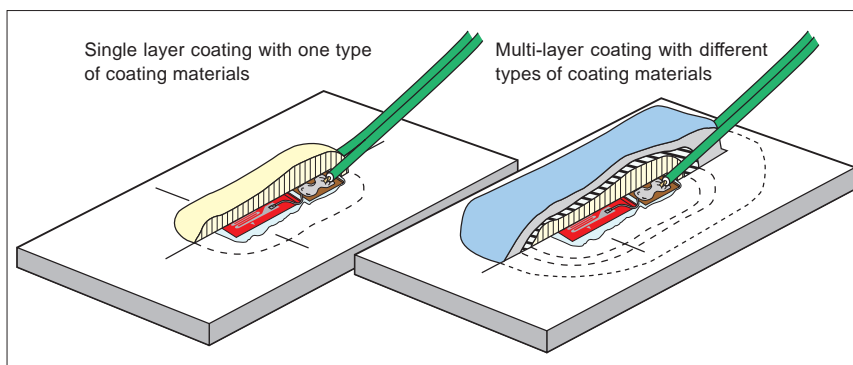

Type	Materials	Color	Contents	Operating temperature	Curing conditions
W-1	Microcrystalline wax solid	Light yellow	500g	0~+50°C	Hot melting +100~+120°C Hardening in room temperature
N-1	Chloroprene rubber based solvent thinned	Light yellow	25g *	-30~+80°C	Air-drying A half day in room temperature
K-1	Special rubber based solvent thinned	White	25g *	-269~+60°C	Air-drying A half day in room temperature
UE-1	Special rubber based solvent thinned	Brown	25g *	-40~+150°C	Air-drying A half day in room temperature
SB tape	Butyl rubber	White	10mm(wide)x3mm (thick) 5m long/roll	-30~+80°C	Pressure sensitive
VM tape	Butyl rubber	Black	38mm(wide) x1mm (thick) 6m long/roll	-20~+80°C	Pressure sensitive
KE-348W	Silicone rubber	White	100g	-50~+200°C	Air-drying A half day in room temperature
KE-348T		Transparent	100g		
TSE3976-B	Silicone rubber	Black	100g	-50~+250°C	Air-drying One day in room temperature

## SDS : Safety Data Sheet

TML supplies SDS for all its strain gauge adhesives and coatings. Contact your TML supplier for more information.

## Coatings in special substances

For use in special substances such as acids, alkalis and alcohols, contact TML or your local representatives.

\* : These contents are for outside Japan.



	Purpose	Applications
	Moisture- and water-proofing coating for laboratory and field requirements where mechanical protection is not needed, or used as the first coating for multi-layer coating.	The solid W-1 is put into a heating apparatus (temperature-regulated oil bath is recommended) and completely melted at 100 to 120°C. The hot melted W-1 is applied over the area to be coated with a brush. The W-1 cools down and turns into solid as soon as applied. It is usually applied repeatedly till the cooled W-1 forms an adequate thickness.
	Moisture- and water-proofing coating for laboratory and less severe field requirements where mechanical protection is not needed.	A layer of N-1 is applied directly from the tube or with a brush over the area to be coated. Curing time is about half a day in room temperature, but it depends on conditions such as the specimen material, temperature, and so on. If the coating layer is too thin, apply another layer to make an adequate thickness.
	Moisture-proofing coating from cryogenic to room temperature for laboratory requirements. Does not provide a high degree of mechanical protection.	A layer of K-1 is applied directly from the tube or with a brush over the area to be coated. Curing time is about half a day in room temperature, but it depends on conditions such as the specimen material, temperature, and so on. If the coating layer is too thin, apply another layer to make an adequate thickness.
	Oil-resistant coating for laboratory and field requirements. Does not provide a high degree of mechanical protection.	A layer of UE-1 is applied directly from the tube or with a brush over the area to be coated. Curing time is about half a day in room temperature, but it depends on conditions such as the specimen material, temperature, and so on. If the coating layer is too thin, apply another layer to make an adequate thickness.
	Moisture- and water-proofing coating for laboratory and field requirements where mechanical protection is not needed, or used as the first coating for multi-layer coating. Offers excellent moisture and water resistant characteristics and is very convenient for use.	The SB tape is cut in an appropriate length and applied over the area to be coated. The application is completed by pressing down the SB tape firmly with a spatula or your finger covered with the separating paper. It is also applied under the leadwire prior to the overcoating.
	Used as the second coating or later for multi-layer coating. Offers excellent moisture and water resistant characteristics. Very convenient for use.	The VM tape is cut in an appropriate length and applied over the area to be coated with finger pressure. The VM tape must not be applied directly over a strain gauge as a first coating.
	Suitable for laboratory requirements with high temperature conditions where high degree of mechanical protection is not needed.	The KE-348 is applied directly from the tube over the area to be coated. Curing time is about half a day in room temperature, but it depends on conditions such as temperature, humidity and so on.
	Suitable for laboratory requirements with high temperature conditions where high degree of mechanical protection is not needed.	The TSE3976-B is applied directly from the tube over the area to be coated. Curing time is about one day in room temperature, but it depends on conditions such as temperature, humidity and so on.



#### Important point

The application of coating material has an effect on test results when repeated strain is applied in the test such as a fatigue test (strain level of  $\pm 1500 \times 10^{-6}$ ).  
Give careful consideration before the test, and apply the coating carefully. Please contact us for further information if necessary.



# Gauge Protector

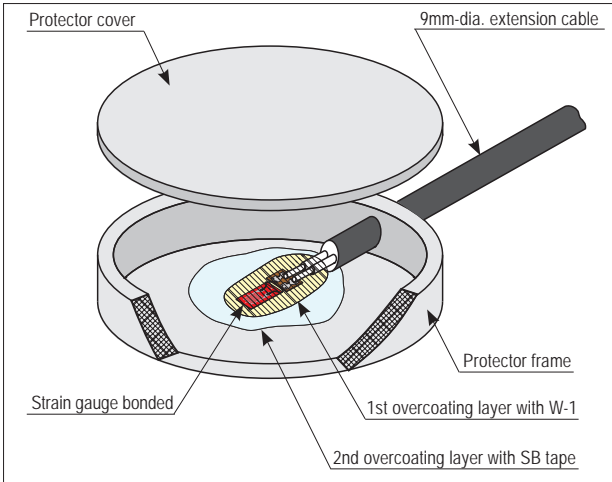

This rubber protector is designed to protect gauges which are bonded onto metal surface from the environment for long-term measurement. The strain gauge is packed inside together with the applied adhesive and overcoating materials. The protector is also provided with a hole for cable intake. It allows the entire area to be isolated from ambient conditions which may affect reliable measurement, and enhances the coating performance.



## Specifications

Dimensions	Frame: 100mm-dia. (Inner $\Phi$ 92mm) x 15mm (Height) Cover: 100mm-dia. x 3mm (Thick)
Operating temperature	-20~+80°C
Extension cable	9mm-dia. cable recommendable



# COATING TAPE for reinforcing bar

This tape is specially designed for use as a waterproof coating for strain gauges bonded onto reinforcing bars or other cylindrical surfaces. Coating is achieved by simply taping it onto the surface to save considerable time in comparison with conventional procedures. (A heat gun is required for application.)

Operating temperature: -20~+80°C



Type	Applicable reinforcing bar	Qty. per box	Strain gauges	Size finish (example)	
				Reinforcing bar	Dia. x Width (mm)
CT-D04	D4	10	FLKB-2-11	D4	$\Phi$ 10×21
CT-D06	D6	10	FLKB-2-11	D6	$\Phi$ 12×21
CT-D10	D10	10	FLKB-2-11	D10	$\Phi$ 15×21
CT-D13	D13	10	FLAB-3-11	D13	$\Phi$ 19×26
CT-D16	D16	10	FLAB-3-11	D16	$\Phi$ 21×26
CT-D25	D19-D25	10	FLAB-3-11	D25	$\Phi$ 31×31
CT-D35	D29-D35	10	FLAB-3-11	D32	$\Phi$ 37×35

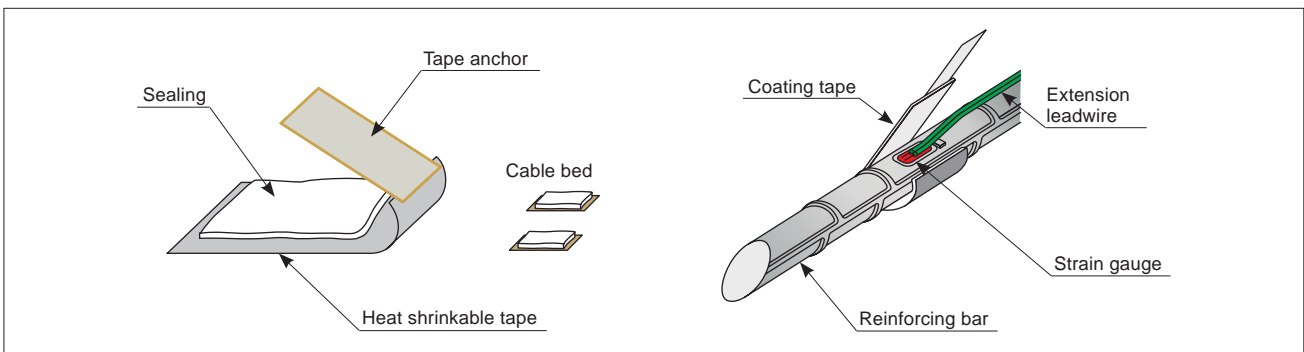



# Connecting Terminals/Strain Gauge Clamp

## Connecting Terminals

TML Connecting Terminals provide convenient junction points to connect strain gauges to instrumentation leadwires.

### Cubic shape

for general purpose

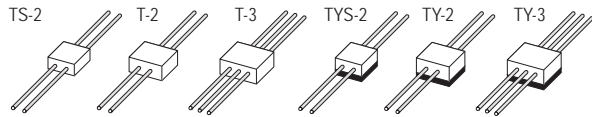

for large strain with rubber backing

Self-bonding type  
(No adhesive required)

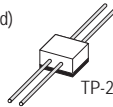

### Foil shape

for general purpose

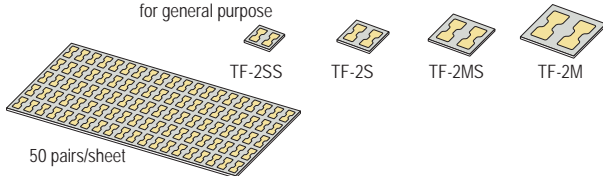

50 pairs/sheet

for large strain with rubber backing



High temperature use with polyimide resin backing

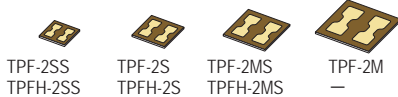

NB: TPFH series are heat-resistant connecting terminals with polyimide resin backing to TPF. It allows high temperature measurement using QF/ZF series gauges and bonding repetition on the terminals.

T series is made of a cubic plastic and two or three wires of approximately 0.8mm diameter are fixed to the cube. TY is laminated with rubber sheet and suitable for large strain measurement. TP-2 is a self-bonding terminal with two wires. TF is made of a 0.03mm thick copper foil and a glass-epoxy insulation base of approx. 0.15mm thick. TFY is laminated with rubber sheet approx. 0.8mm thick over the back side of TF series terminals.

### Cubic type

Type	Dimensions (mm)	Operating temperature (°C)	Quantity (pcs/box)
T-2	10×10×5	-20~+90	100
T-3 (3-wire method)	10×10×5	-20~+90	100
TS-2	7.5×7.5×5	-20~+90	100
TYS-2	7.5×7.5×7	-20~+90	100
TY-2	10×10×7	-20~+90	80
TY-3 (3-wire method)	10×10×7	-20~+90	80
TP-2	10×10×6	-20~+60	100

### Foil type

Type	Dimensions (mm)	Operating temperature (°C)	Quantity (pairs/sheet)
TF-2SS	4.6×3.8×0.2	-196~+180	50
TF-2S	6×5.3×0.2	-196~+180	50
TF-2MS	8×7.2×0.2	-196~+180	50
TF-2M	10×9.2×0.2	-196~+180	50
TFY-2SS	4.6×3.8×0.8	-20~+120	50
TFY-2S	6×5.3×0.8	-20~+120	50
TFY-2MS	8×7.2×0.8	-20~+120	50
TFY-2M	10×9.2×0.8	-20~+120	50
TPF-2SS	4.6×3.8×0.2	-196~+200	50
TPF-2S	6×5.3×0.2	-196~+200	50
TPF-2MS	8×7.2×0.2	-196~+200	50
TPF-2M	10×9.2×0.2	-196~+200	50
TPFH-2SS	4.6×3.8×0.1	-269~+350	50
TPFH-2S	6×5.3×0.1	-269~+350	50
TPFH-2MS	8×7.2×0.1	-269~+350	50

## Strain Gauge Clamp

### Gauge Mate GMR-S/GMA-S

When bonding a strain gauge, a fixing pressure should be applied to the gauge until curing is completed. This can be easily done using TML Gauge Mate, which is a gauge clamp device consisting of a coil spring and a permanent magnet. For use on specimens of different shapes, two types are available. Model GMA-S is for flat specimens, and model GMR-S is for round specimens. Both can be used with room-temperature curing type bonding adhesives.

Type	Application
GMR-S	Round specimen use (6~32mm-dia.)
GMA-S	Flat surface of magnetic body (1mm thick or over)

N.B: Strain gauge clamp should be used in room temperature.

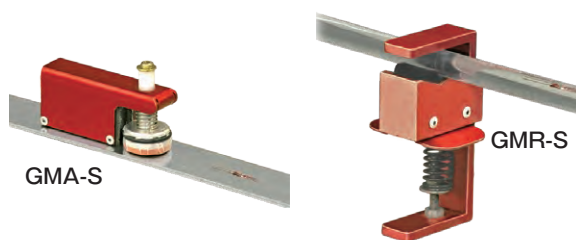

### Pressing Jig PRESSEE PM-19

PRESSEE is a pressing jig capable of not only pressurizing the strain gauge but also checking adhesion status from the clear pressing part with eyes. The use of PRESSEE saves time to keep pressing the strain gauge with your finger in the bonding work. In addition, since the PRESSEE can apply a constant pressure to the strain gauge, bonding quality is expected to be higher than a finger pressure.

Applicable strain gauge	Gauge length of 6mm or less and backing dimension of 15mm-dia. or less
Applicable adhesive	CN/CN-R/CN-Y, P-2, NP-50B, EA-2A, EB-2
Pressing method	Magnetic method by permanent magnet
Object to be bonded	Flat surface of magnetic body (1mm thick or over)
Dimensions	29mm-dia. x Approx. 30mm height











## TML Strain measuring instruments

## TML Data logger series

Data loggers of high accuracy and stability developed through many years of experience

Data Logger	Measurement Box	Number of measuring point	Measuring Time [interval for measurement]
<b>High speed • High accuracy • High functionality Data Logger T-ZACCS9 TS-960</b>  Interface: LAN/USB/RS-232C	Built-in Unit	10	High speed : 0.1 seconds (0.1 seconds)/High accuracy : 0.4 seconds (0.4 seconds)
	T-ZACCS BOX EX-50H	1000	High speed : 0.1 seconds (0.1 seconds)/High accuracy : 0.4 seconds (0.4 seconds)
Data Logger	Switching Box	Number of measuring point	Scanning Time [Time required for measurement]
<b>High Performance Data Logger TDS-630</b>  Interface: LAN/USB/RS-232C * : Combination with parallel communication unit PCU-4A	IHW-50H	1000	0.1 seconds : at High speed/On-line mode IHW-50H
	IHW-50G-01*	50	0.1 seconds* : at High speed/On-line mode
	IHW-50G	1000	0.4 seconds/1000 points (0.04 seconds/point) [1 second] IHW-50G
	ISW-50G	1000	2 seconds/1000 points (0.04 seconds/point) [3 seconds] IHW-50G
	ASW-50C SSW-50D	1000	60 seconds/1000 points (0.06 seconds/point) [60 seconds]
	Built-in (High speed)	30	0.1 seconds : at High speed/On-line mode
<b>Data Logger TDS-540</b>  Interface: LAN/USB/RS-232C	IHW-50G	1000	0.4 seconds/1000 points (0.04 seconds/point) [1 second]
	ISW-50G	1000	2 seconds/1000 points (0.04 seconds/point) [3 seconds] SSW-50D
	ASW-50C SSW-50D	1000	80 seconds/1000 points (0.08 seconds/point) [80 seconds]
	Built-in (High speed)	30	0.4 seconds/30 points (0.04 seconds/point) [1 second]
	Built-in (Standard)	30	1.2 seconds/30 points (0.04 seconds/point) [2 second]
<b>T-ZACCS5 Data Logger TS-560</b>  Interface: LAN/USB/RS-232C	IHW-50G	1000	0.4 seconds/1000 points (0.04 seconds/point) [1 second]
	ISW-50G	1000	2 seconds/1000 points (0.04 seconds/point) [3 seconds]
<b>Portable Data Logger TDS-150</b>  Interface: USB/RS-232C LAN (option)	FSW-10	50	4 seconds/50 points (0.08 seconds/point) [4 seconds] FSW-10
	FSW-10L	50	4 seconds/50 points (0.08 seconds/point) [4 seconds] FSW-10L
<b>Handheld Data Logger TC-32K</b>  Interface: : USB/RS-232C	CSW-5B	5	0.4 seconds/5 points (0.08 seconds/point) [1 second]
	Not used (TC-32K only)	1	0.08 seconds/1 point (0.08 seconds/point) [1 second] CSW-5B CSW-5B-05

Data loggers are equipped with functions of calculation, storage and processing of measured data in addition to automatic scanning measurement of multiple points. Not only strain but also voltage and temperature are accepted as measurement objects of data loggers.

## Software TDS-7130v2 for TS-960/TDS-630/TS-560/TDS-540/TDS-150/TC-35N

- Data analysis using various calculation functions
- Visually appealing measurement possible using various monitor graphs and numerical monitor displays
- Other graph data are easily overlaid and quick data reduction is enabled
- Alarm setting possible for each measured value and calculation result

## Software TDS-700L for TS-560/TDS-540/TDS-150/TC-32K/TC-35N

- Direct saving of measured data into Excel worksheet
- Simple and quick operation from measurement to data processing possible utilizing Excel functions
- Number of measurement channels is 200 at the maximum



## Multi-Channel dynamic data acquisition system with DS-50A

A low cost measurement system mainly targeted on strain gauges



- 50 measurement channels for one set of DS-50A
- Simultaneous sampling of 1 millisecond possible when one set is used
- Direct connection of 120Ω or 350Ω strain gauge in quarter bridge
- Numerical, statistical and trigonometric calculation and rectangular rosette analysis
- Peak values of up to 20 points are displayed in the spectral chart
- Magnitude and direction of the force obtained by rectangular rosette analysis are displayed as a vector
- Cutting out, thinning and combining of the data are possible for processing after the measurement
- Overlapping of T-Y, X-Y and spectral chart on other data is possible

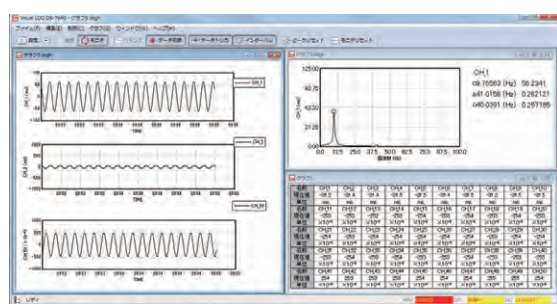

Number of channels	Maximum 50 channels Strain, Voltage and Thermocouple units can be mixed. 10 channels / 1 unit
Synchronization	Maximum 20 sets (1,000 channels)
Sampling speed	1~10,000 ms (Settable by 1 ms). 1 ms is added to sampling speed per additional connection of 1 set
Interface	LAN (100 BASE-TX)
<b>Strain unit</b>	
Gauge resistance	Quarter bridge 3-wire 120Ω, 350Ω Half bridge 120~1000Ω, Full bridge 120~1000Ω
Frequency response	DC~100Hz
<b>Voltage unit</b>	
Input format	Single end (unbalanced)
Measuring range	±20V
Frequency response	DC~100Hz
<b>Thermocouple unit</b>	
Measuring range	T:-250~ +400°C K:-210 ~ +1370°C J:-200~ +1200°C
Frequency response	DC~10Hz

## Small Multi-channel Data Acquisition System

### Multi-Recorder TMR-300 Series

Number of channels : 80  
 Sampling speed :  
     Max 100kHz  
 Recording media :  
     SD card  
     (Max.32GB)  
 Interface : LAN, USB



Multi-recorder TMR-300 Series is a compact multi-channel data acquisition system that can combine various measurement units according to the purpose of measurement. Due to its compact size and light weight, the system can be easily installed not only on existing structures such as machines and bridges in which the installation space is restricted, but also on moving bodies such as automobiles, aircrafts and ships.

Measurement units for inputting sensors are available in several types for strain gauges, strain gauge type transducers, DC voltage or thermocouples. Control unit is used for controlling 10 measurement units (80 measurement points) at maximum and communicating with a computer. The control unit and the measurement units can be connected together and placed in a small space, or each measurement unit can be installed in the vicinity of the sensors to be inputted.

### Measuring units

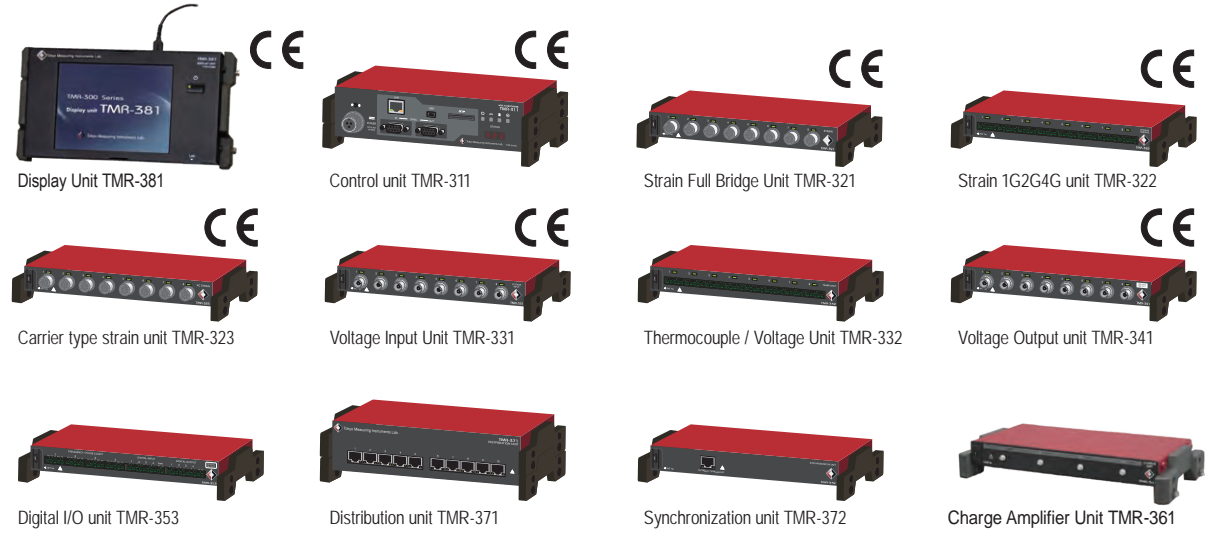

Display Unit TMR-381

Control unit TMR-311

Strain Full Bridge Unit TMR-321

Strain 1G2G4G unit TMR-322

Carrier type strain unit TMR-323

Voltage Input Unit TMR-331

Thermocouple / Voltage Unit TMR-332

Voltage Output unit TMR-341

Digital I/O unit TMR-353

Distribution unit TMR-371

Synchronization unit TMR-372

Charge Amplifier Unit TMR-361



Tokyo Sokki Kenkyujo Co., Ltd. (TML) is accredited by Japan Calibration Service System (JCSS), conformed to international standards JIS Q 17025 (ISO/IEC 17025) under the laboratory accreditation body ISO/IEC 17011. International Accreditation Japan (IA Japan) plays as the accreditation body of JCSS and is a signatory to MRA of Asia Pacific Accreditation Cooperation (APAC) as well as International Laboratory Accreditation Cooperation (ILAC). Our Kiryu factory is certified as a JCSS-accredited laboratory working in compliance with an international Mutual Recognition Arrangement (MRA). The accreditation number of the Kiryu Factory is 0090.



Approval Certificate **ISO9001**  
Design and manufacture of  
strain gauges, strain measuring  
equipment and transducers



## Tokyo Measuring Instruments Lab.

**URL** [www.tml.jp/e](http://www.tml.jp/e)

8-2, Minami-ohi 6-chome, Shinagawa-ku, Tokyo 140-8560, JAPAN  
TEL: +81-3-3763-5614 FAX: +81-3-3763-5713

The contents of this catalog are subject to change without prior notice.  
The contents of this catalog are as of June 2021. TML Pam E-1007G