



Web Slings & Round Slings



DISTRIBUTED BY : TITAN SERVICE CO.,LTD.

www.titanservice.co.th





Technotex is a manufacture company of a complete range of polyester webbing slings for all lifting and lashing applications, which includes our Techlon, Heavy Duty and Multicode round and flat webbing slings, and associated products. Our high quality products are manufactured in accordance with the latest European and International standards.



Technotex Industrial Supply is a member of an international organisation "Unitex group of Companies" with manufacturing operations throughout Europe and Far East, and it provides business-to-business services to industries worldwide. We welcome the opportunity of being of service to you and we confirm our Q.A. approved accreditation with A.I.B. Vincotte Belgium. All Technotex products fully comply with current European and International standards, as specified by the latest EN 1492-1 for flat webbing, EN 1492-2 for all round slings and EN 12195-2 for the lashingsystems. We also conform to Machinery Directives 98/37/EG (last amendment 98/79/EG). Meanwhile, we aspire to become a preferred supplier to your organisation. Should you require any further information, please do not hesitate to contact our company or our distribution network, where our skilled technical and sales staff will be only too pleased to help fulfil your requirements.

1. EN-Standards and Machinery Directives

For all European manufacturers are the technical demands and the references how to produce textile lifting equipment like roundslings and webslings summarized in the EN 1492-1 (Webslings) and the EN 1492-2 (Roundslings). Additionally the textile lifting equipment is encoded with the CE mark according to the Machinery Directive 2006/42/EG



2. Testing and Maintenance

To guarantee a safe way of using the textile lifting equipment they must be tested at least one time per year or according to the latest publications of the standard or local guidelines. The operator of the equipment has to arrange independently of predetermining operation conditions several test intervals.

These tests may only be done by competent persons. Possibly damaged Roundslings/Webslings may only be repaired by the manufacturer or by people who have become the power of attorney to repair from the manufacturer.

To guarantee the quality of our products the standard Webslings and Roundslings are being certified by the AIB Vinchotte (VGS), Berufsgenossenschaft (GS) or Lloyds.



3. Lifting of loads (WLL Capacity table and lifting angle)

If a load with a certain weight has to be lifted, the person who has to coordinate this job has to make sure the correct lifting materials are chosen.

Also the number of slings, the capacity and the length has to be defined. It is also to plan the lifting procedure and to make sure that the angle of inclination is not more than 60 degrees (an angle of more than 60 degrees is forbidden!)

The bigger the angle of inclination, the smaller the practical capacity of the lifting equipment.

As a simple rule you can say:

By an angle of inclination up to 45 degrees the chosen lifting equipment can be calculated with only 70% of the original capacity. For example:

$$70\% \text{ of } 2T = 0,7 \times 2T = 1,4T$$

By an angle of inclination up to 60 degrees the chosen lifting equipment can be calculated with only 50% of the original capacity. For example:

$$50\% \text{ of } 2T = 0,5 \times 2T = 1,0T$$

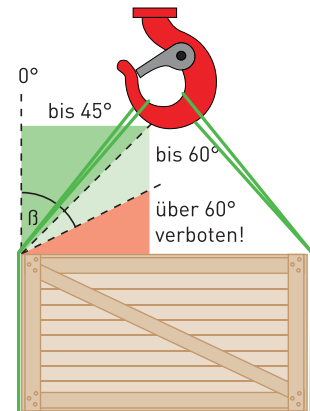

Overview of the lifting band shapes and -versions according to DIN EN 1492-1

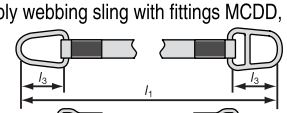
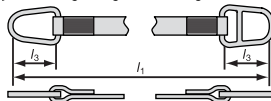
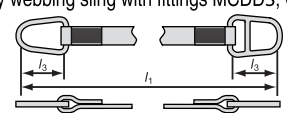
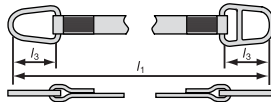
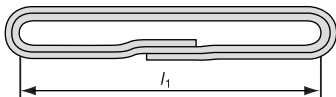
FORM	A continuous MDEE , MCDD	C + CR - Flat websling with fittings MCDD, MCDDs
Load bearing fittings		 C  Cr
Load-bearing parts (simple)		Single ply webbing sling with fittings MCDD, C1 / Cr1 
Load-bearing parts (two times)	Single ply webbing sling MCEE A2 	Two-ply webbing sling with fittings MCDDs, C2 / Cr2 
Load-bearing parts (four times)	Two-ply webbing sling MCEd A4 	

4. Way of use and handling

The European Norm has given each capacity in the EN 1492/1-2 a specific colour. This to identify the capacity of webslings and roundslings easily and clearly

- WLL 1,0 t
- WLL 2,0 t
- WLL 3,0 t
- WLL 4,0 t
- WLL 5,0 t
- WLL 6,0 t
- WLL 8,0 t
- WLL 10,0 t and >10 t



To make sure the stitching of the eye of a websling wont break open, the angle of opened eye of the websling shouldn't be more than 20 degrees when it is put into a cranehook

The following rule has to be followed:

You are on the safe side as the eye of the websling at least 3,5 x as long is as the thickness of the cranehook

$$L2 \geq b \times 3,5$$

Be careful: sharp edges will not only damage lifting equipment, but can also lead to accidents

For this reason:

The corner radius ,r' must always be bigger than the strength ,d' of the lifting equipment If loads with sharp edges have to be lifted corner protection definitely has to be used. For example Purfecta or Ultra Protect corner protection solutions from Unitex.

Warnung : Due to slipping of the load, both corner protection systems, Purfecta and Ultra Protect, can be damaged

Lifting equipment made of polyester fibres with their marked capacity can be used in temperatures between -40 degrees and +100 degrees C.

If they are being used in connection with chemicals it is absolutely necessary to contact the manufacturer beforehand for permission.

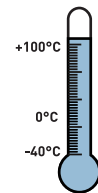
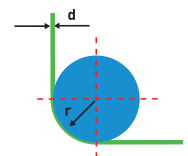
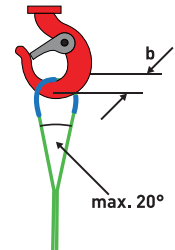

WARNING: Lifting straps and slings



Nodes are prohibited.



When the influence of chemicals is, consultation with the supplier.



Weight lifting of good control on overload! Consider gravity of the load.



Damaged slings and lifting slings store and replace.



Respect to temperature range (- 40 ° to + 100 ° C)



Protect slings and lifting slings from sharp edges.



Rebate and consider inclination angle.



Round slings never put on the top of the crane hook!

LIFTING BELTS AND ROUND SLINGS BEFORE USE ALWAYS ON DAMAGE KONTROLIEREN!

Differences and characteristics of different types of hoses

TYPE	ULTRALIFT	TLX	DT	TE
Material	Dyneema®	Polyester	Polyester	Polyester
Tissue	specialy strengthened mesh	Reinforced	double hose	easily
Abrasion resistance	++++	++	-/+	-/+
Cut resistance	++++	++	-/+	-/+
Temperature range	-60° to 70°C	-40° to 100°C	-40° to 100°C	-40° bis 100°C
Acids	++	++	++	++
Alkali	++	-	-	-
Micro organism	++++	++	++	++
UV resistance	++++	++	++	++
Assortment	"2 and 180 t only with core Dyneema®"	1 and 150 t	1 and 10 t	1 and 10 t

Webbing and Roundslings and Ultra Lift made with Dyneema® Polyester

Load carrying capacity for webbing slings and round slings and Ultra Lift made with Dyneema® Polyester

Lifting slings and Round Slings	Ultra Lift Round slings Dyneema® fibers	Working Load Limits with 1 webbing sling or round sling						Working Load Limits with 2 webbing slings or round slings					
		Straight lift	Choked lift	*β		*β		*β		*β			
				0°-7°	7°-45°	45°-60°	7°-45°	45°-60°	7°-45°	45°-60°	7°-45°	45°-60°	
Colour code according to EN 1492-1/2	Color loop Dynema uniformly white	Factor	1	0,8	2	1,4	1	0,7	0,5	1,4	1	1,12	0,8
WLL 1 t	-----		1	0,8	2	1,4	1	0,7	0,5	1,4	1	1,12	0,8
WLL 2 t	WLL 2 t		2	1,6	4	2,8	2	1,4	1	2,8	2	2,24	1,6
WLL 3 t	WLL 3 t		3	2,4	6	4,2	3	2,1	1,5	4,2	3	3,36	2,4
WLL 4 t	WLL 4 t		4	3,2	8	5,6	4	2,8	2	5,6	4	4,48	3,2
WLL 5 t	WLL 5 t		5	4	10	7	5	3,5	2,5	7	5	5,6	4
WLL 6 t	WLL 6 t		6	4,8	12	8,4	6	4,2	3	8,4	6	6,72	4,8
WLL 8 t	WLL 8 t		8	6,4	16	11,2	8	5,6	4	11,2	8	8,96	6,4
WLL 10 t	WLL 10 t		10	8	20	14	10	7	5	14	10	11,2	8
WLL 12 t	WLL 12 t		12	9,6	24	16,8	12	8,4	6	16,8	12	13,44	9,6
WLL 15 t	WLL 15 t		15	12	30	21	15	10,5	7,5	21	15	16,8	12
WLL 20 t	WLL 20 t		20	16	40	28	20	14	10	28	20	22,4	16
WLL 25 t	WLL 25 t		25	20	50	35	25	17,5	12,5	35	25	28	20
WLL 30 t	WLL 30 t		30	24	60	42	30	21	15	42	30	33,6	24
WLL 40 t	WLL 40 t		40	32	80	56	40	28	20	56	40	44,8	32
WLL 50 t	WLL 50 t		50	40	100	70	50	35	25	70	50	56	40
WLL 60 t	WLL 60 t		60	48	120	84	60	42	30	84	60	67,2	48
WLL 70 t	WLL 70 t		70	56	140	98	70	49	35	98	70	78,4	56
WLL 80 t	WLL 80 t		80	64	160	112	80	56	40	112	80	89,6	64
WLL 90 t	WLL 90 t		90	72	180	126	90	63	45	126	90	100,8	72
WLL 100 t	WLL 100 t		100	80	200	140	100	70	50	140	100	112	80
WLL 120 t	WLL 120 t		120	96	240	168	120	84	60	168	120	134,4	96
-----	WLL 140 t		140	112	280	196	140	98	70	196	140	156,8	112
WLL 150 t	-----		150	120	300	210	150	105	75	210	150	168	120
-----	WLL 160 t		160	128	320	224	160	112	80	224	160	179,2	128
-----	WLL 180 t		180	144	360	252	180	126	90	252	180	201,6	144
-----	WLL 200 t		200	160	400	280	200	140	100	280	200	224	160

**This table shows the carrying capacities of under normal conditions of use.

The advantage Eder Ultra Lift-round slings

- Low dead weight of the loops over polyester round slings (2.5x lighter than PES) and wire ropes (up to 8x easier).
- Extremely High abrasion resistance and significantly longer lifetime when properly used.
- Low Expansion of the loops (like steel).
- The low stretch very precise strokes are possible without Nachpendeln the load.
- Bessere Review of loops on rope discard, wire ropes or chains than.
- Etc. No formation of wire breaks, Latches, Klanken
- Cost savings through quick handling.
- Low risk of injury.

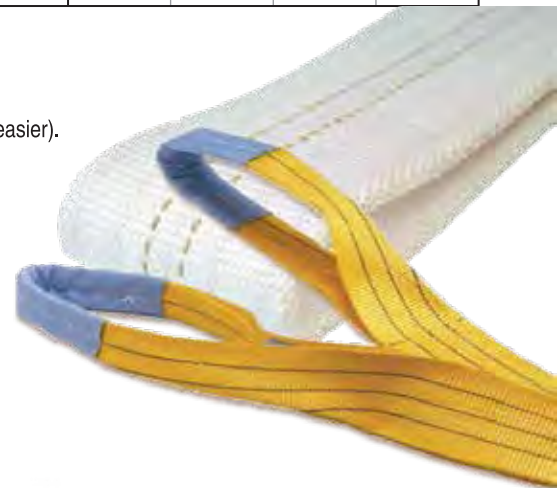

TYPE MC WEB SLINGS 2-LAYER • according to DIN EN 1492-1

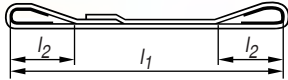

Fully Reinforced crane straps are available on request.

Type	WLL	Webbing width (mm)	Thickness (mm)	Eye length effective length mm (L2)			Standard eye type	Weight kg L (1)			Weight each meter extra
				1 m	2 m	3 m		1 m	2 m	3 m	
MC30	WLL 1 t	30	7	250	400		type 1	0,25	0,45	0,65	0,20
MC60	WLL 2 t	60	6	250	400		type 3	0,44	0,79	1,14	0,35
MC90	WLL 3 t	90	7,5	250	400		type 3	0,71	1,25	1,80	0,55
MC120	WLL 4 t	120	8		450		type 4		1,67	2,40	0,73
MC150	WLL 5 t	150	7		550		type 4		2,12	3,06	0,94
MC180	WLL 6 t	180	7		600		type 4		2,95	4,14	1,20
MC240	WLL 8 t	240	8			750	type 4			5,25	1,50
MC300	WLL 10 t	300	7			1000	type 4			6,85	1,97
MC300	WLL 12 t	300	8			1000	type 4			8,35	2,36

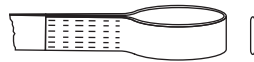

Type 1 : Flat eye

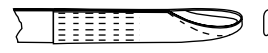

Type 3 : Folded eye 1/2 width from one side



Type 5 : Folded eye 1/3 width



Type 2 : Reversed eye



Type 4 : Folded eye 1/2 width from two sides

MCEE / MCED endless web slings

MCEE ENDLESS WEB SLINGS 1 LAYER • DIN EN 1492-1

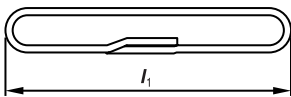

Type	WLL	Webbing width (mm)	Thickness (mm)	Weight kg (L1)		Weight 0,5 meter extra (kg)
				0,5 m	1 m	
MCEE30	WLL 1 t	30	3,5	0,12	0,21	0,09
MCEE60	WLL 2 t	60	3	0,21	0,38	0,17
MCEE90	WLL 3 t	90	4	0,34	0,60	0,26
MCEE120	WLL 4 t	120	4		0,82	0,35
MCEE150	WLL 5 t	150	3,5		1,06	0,45
MCEE180	WLL 6 t	180	3,5		1,45	0,58
MCEE240	WLL 8 t	240	4		1,84	0,72
MCEE300	WLL 10 t	300	3,5		2,47	0,95
MCEE300	WLL 12 t	300	4		3,14	1,14

MCED ENDLESS WEB SLINGS 2-LAYER • DIN EN 1492-1

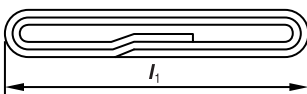

Type	WLL	Webbing width (mm)	Thickness (mm)	Weight kg (L1)		Weight 0,5 meter extra (kg)
				0,5 m	1 m	
MCED30	WLL 2 t	30	7	0,22	0,41	0,19
MCED60	WLL 4 t	60	6	0,39	0,73	0,34
MCED90	WLL 6 t	90	7,5	0,62	1,16	0,54
MCED120	WLL 8 t	120	8		1,57	0,72
MCED150	WLL 10 t	150	7		2,02	0,93
MCED180	WLL 12 t	180	7		2,69	1,19
MCED240	WLL 16 t	240	8		3,37	1,48
MCED300	WLL 20 t	300	7		4,5	1,96
MCED300	WLL 24 t	300	8		5,58	2,35

MCDD 2-LAYER WEB SLINGS WITH TRIANGLES (MALE/MALE)



Type	WLL	Webbing width (mm)	Thickness (mm)	Weight kg (L1)			Weight 1 meter extra (kg)
				1 m	2 m	3 m	
MCDD30	WLL 1 t	30	7	0,62	0,82	1,02	0,20
MCDD60	WLL 2 t	60	6	1,39	1,74	2,09	0,35
MCDD90	WLL 3 t	90	7,5	2,78	3,33	3,88	0,55
MCDD120	WLL 4 t	120	8		4,68	5,41	0,73
MCDD150	WLL 5 t	150	7		6,19	7,13	0,94
MCDD180	WLL 6 t	180	7		8,51	9,71	1,20
MCDD240	WLL 8 t	240	8			16,24	1,50
MCDD300	WLL 10 t	300	7			21,68	1,97
MCDD300	WLL 12 t	300	8			22,97	2,36

MCDDS 2-LAYER WEB SLINGS WITH TRIANGLES (MALE/FEMALE)



Type	WLL	Webbing width (mm)	Thickness (mm)	Weight kg (L1)			Weight 1 meter extra (kg)
				1 m	2 m	3 m	
MCDDS30	WLL 1 t	30	7	0,82	1,02	1,22	0,20
MCDDS60	WLL 2 t	60	6	1,86	2,21	2,56	0,35
MCDDS90	WLL 3 t	90	7,5	3,63	4,21	4,76	0,55
MCDDS120	WLL 4 t	120	8		6,11	6,84	0,73
MCDDS150	WLL 5 t	150	7		8,90	9,84	0,94
MCDDS180	WLL 6 t	180	7		10,79	11,99	1,20
MCDDS240	WLL 8 t	240	8			20,45	1,50
MCDDS300	WLL 10 t	300	7			27,31	1,97

MCDD and MCDDS • TRIANGLES SPECIFICATIONS

Male Triangles

Type	WLL	Width (mm)	Q (mm)	D (mm)	H (mm)	E (mm)	Weight per Piece (kg)
DTR/010	WLL 1 t	30	12	45	60	70	0,2
DTR/020	WLL 2 t	60	16	30	80	100	0,5
DTR/030	WLL 3 t	90-100	20	60	120	146	1,1
DTR/040	WLL 4 t	120	23	60	130	179	1,6
DTR/050	WLL 5 t	150	26	90	180	222	2,2
DTR/060	WLL 6 t	180	28	90	180	262	3
DTR/080	WLL 8 t	240	32	100	200	344	5,8
DTR/100	WLL 10 t	300	35	100	250	400	7,9

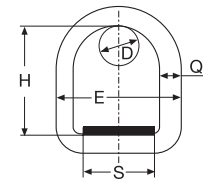

DTR/010

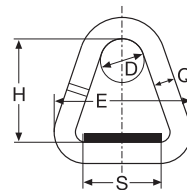

DTR/020 to DTR/100

FEMale Triangles

Type	WLL	Width (mm)	Q (mm)	D (mm)	H (mm)	P (mm)	Weight per Piece (kg)
DSTR/010	WLL 1 t	30	12	50	100	25	0,4
DSTR/020	WLL 2 t	60	16	40	146	40	1
DSTR/030	WLL 3 t	90-100	20	70	205	55	2
DSTR/040	WLL 4 t	120	23	80	218	55	3,1
DSTR/050	WLL 5 t	150	26	90	300	80	5
DSTR/060	WLL 6 t	180	28	90	284	80	5,4
DSTR/080	WLL 8 t	240	32	120	332	90	10,2
DSTR/100	WLL 10 t	300	35	120	385	100	13,8

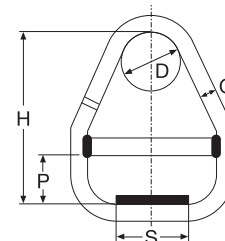

DSTR/010 to DSTR/100

TDQ 4-layer web slings



TDQ • 4- LAYER WEB SLINGS



Material : TDQ web slings are built up out of 4-layers polyester (PES) and are available as three versions: TDQ web slings are made out 100% polyester. The TDQDD and TDQDDS are manufactured with steel triangles (grade 80).

Properties:

Fysical properties

Specific Gravity (g/cm3)	:	1,38
Elongation at WLL (in %)	:	3-4
Usable at temperature	:	-40°C - +100°C
Moisture regain %	:	< 0,5
Resistance to mineral Acid*	:	Good
Resistance to Alkalis*	:	Poor

* Always consult the producer.

Application:

TDQ web slings are for general use for lifting loads from WLL 2 ton up to 40 ton. (straight lift). The width of the webbing sling contributes to a stable and safe lift. For special applications where the standard assortment does not fit, Technotex Industrial Supply can offer custom made solutions. For the standard assortment we refer to the enclosed product sheets.

Standards:

- TDQ web slings comply with the Machinery Directive 2006/42/EG
- TDQ web slings have a CE-mark, according to the Machinery Directive requirements. (Europe).
- Techlon web slings comply with NEN-EN 1492-2 (europe), BS 3481/part2-1983 safety factor 6:1 (Middle East, asia), as 4497.1-1997 (Australia), OSHA/ASME B30.9 (USA)

LIFTING STRAPS with LOOP TYPE TDQ • 4-LAYER WEB SLING • according to DIN EN 1492-1



Fully Reinforced crane straps are available on request.

Type	WLL	Webbing width (mm)	min. L1 m	Standard Eye Type	Loop length approx. (mm)	loop width approx. (mm)
TDQ 030	WLL 2 t	30	1	Type 1	350	30
TDQ 060	WLL 4 t	60	1,30	Type 3	400	50
TDQ 090	WLL 6 t	90	1,60	Type 3	500	60
TDQ 120	WLL 8 t	120	2	Type 3	600	70
TDQ 150	WLL 10 t	150	2,20	Type 4	700	85
TDQ 180	WLL 12 t	180	2,50	Type 4	800	100

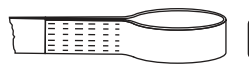

Type 1 : Flat loop

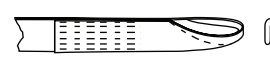

Type 3 : Folded eye 1/2 width from one side

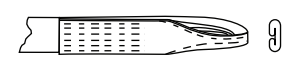

Type 4 : Folded eye 1/2 width from two sides

WEIGHT of TYPE TDQ • 4- LAYER WEB SLINGS

Type	TDQ						
	TDQ150	TDQ180	TDQ240	TDQ300	TDQH300	TDQ500	TDQ600
WLL	10 t	12 t	15 t	20 t	25 t	30 t	40 t
Eye width	80 mm	95/105	125 mm	160 mm	160 mm	260 mm	310 mm
Eye length	650 mm	700 mm	850 mm	1100 mm	1200 mm	1500 mm	1500 mm
Webbing width	150 mm	180/200	240 mm	300 mm	300 mm	500 mm	600 mm
EWL in mtr	kg						
4	7,7	10,1	12,4	16,3	19,6	26,5	41,0
5	9,6	12,5	15,4	20,3	24,3	32,9	50,8
6	11,4	14,9	18,3	24,2	29,0	39,2	60,6
7	13,3	17,3	21,3	28,1	33,7	45,6	70,4
8	15,1	19,7	24,3	32,0	38,4	52,0	80,2
9	17,0	22,1	27,2	35,9	43,1	58,4	90,1
10	18,8	24,5	30,2	39,8	47,8	64,7	99,9
11	20,7	26,9	33,2	43,7	52,5	71,1	109,7
12	22,5	29,3	36,1	47,6	57,2	77,5	119,5
More weight per m NL	1,9	2,4	3,0	3,9	4,7	6,4	9,8

* Other lengths are available on request.

WEIGHT of TYPE TDQDD and TDQDDS • 4-LAYER WEB SLING with TRIANGLES

Type	TDQDD				
	TDQDD150	TDQDD180	TDQDD240	TDQDD300	TDQHDD300
WLL	10 t	12 t	15 t	20 t	25 t
Webbing width (mm)	150	180/200	240	300	300
Weight Triangle	12,6	15,6	28,8	47,8	47,8
EWL in mtr	kg				
4	20,3	25,7	41,2	64,1	67,4
5	22,2	28,1	44,2	68,1	72,1
6	24,0	30,5	47,1	72,0	76,8
7	25,9	32,9	50,1	75,9	81,5
8	27,7	35,3	53,1	79,8	86,2
9	29,6	37,7	56,0	83,7	90,9
10	31,4	40,1	59,0	87,6	95,6
11	33,3	42,5	62,0	91,5	100,3
12	35,1	44,9	64,9	95,4	105
13	37	47,3	67,9	99,3	109,7
14	38,8	49,7	70,9	103,2	114,4
15	40,7	52,1	73,9	107,2	119,1
16	42,5	54,5	76,8	111,1	123,8
17	44,4	56,9	79,8	115	128,5
18	46,2	59,3	82,8	118,9	133,2
19	48,1	61,7	85,7	122,8	137,9
20	49,9	64,1	88,7	126,7	142,6
Extra per mtr. working length*	1,8	2,4	2,9	3,9	4,7

TDQDDS				
TDQDDS150	TDQDDS180	TDQDDS240	TDQDDS300	TDQHDDS300
10 t	12 t	15 t	20 t	25 t
150	180	240	300	300
19,3	30	41,6	71,4	71,4
27	33,4	54	87,7	91
28,9	35,8	57	91,7	95,7
30,7	38,2	59,9	95,6	100,4
32,6	40,6	62,9	99,5	105,1
34,4	43	65,9	103,4	109,8
36,3	45,4	68,8	107,3	114,5
38,1	47,8	71,8	111,2	119,2
40	50,2	74,8	115,1	123,9
41,8	52,6	77,7	119	128,6
43,7	55	80,7	122,9	133,3
45,5	57,4	83,7	126,8	138
47,4	59,8	86,7	130,8	142,7
49,2	62,2	89,6	134,7	147,4
51,1	64,6	92,6	138,6	152,1
52,9	67	95,6	142,5	156,8
54,8	69,4	98,5	146,4	161,5
56,6	71,8	101,5	150,3	166,2
1,9	2,4	3	3,9	4,7

*Other lengths are available on request.

TRIANGLE Type TDQDD SPECIFICATIONS

Type	WLL	S (mm)	Q (mm)	D (mm)	H (mm)	E (mm)	Weight (kg)
DTR/10	WLL 10 t	180	35	100	200	320	6,3
DTR/12	WLL 12 t	170	40	90	200	290	7,8
DTR/15	WLL 15 t	300	45	150	250	440	14,4
DTR/20	WLL 20 t	300	50	180	300	460	19
DTR/25	WLL 25 t	300	55	180	300	492	23,9
DTR/30	WLL 30 t	300	55	180	300	492	23,9

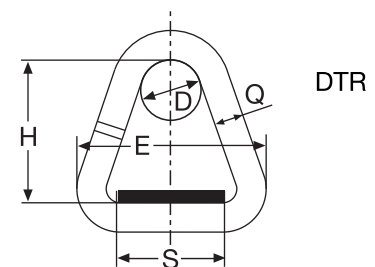

TRIANGLE Type TDQDDS SPECIFICATIONS

Type	WLL	S (mm)	Q (mm)	D (mm)	H (mm)	P (mm)	Weight (kg)
DSTR/10	WLL 10 t	180	35	100	340	100	13
DSTR/12	WLL 12 t	170	40	100	340	100	15,5
DSTR/15	WLL 15 t	250	45	150	466	120	27,2
DSTR/20	WLL 20 t	300	50	180	540	150	26
DSTR/25	WLL 25 t	300	55	180	540	150	47,5
DSTR/30	WLL 30 t	300	55	180	540	150	47,5

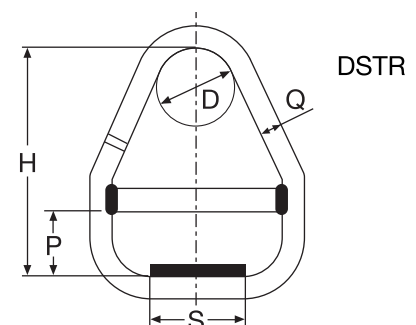

TE Round slings



TE ROUND SLINGS WITH SINGLE SLEEVE



Type	WLL	Sleeve width (mm)	Round sling diameter	Weight of round sling 0,5 m effective length (kg)	Weight per 0,5 m extra (kg)
TE 010	WLL 1 t	47	12	0,118	0,103
TE 020	WLL 2 t	48	18	0,185	0,170
TE 030	WLL 3 t	54	20	0,264	0,248
TE 040	WLL 4 t	70	22	0,356	0,334
TE 050	WLL 5 t	72	28	0,431	0,407
TE 060	WLL 6 t	74	30	0,528	0,504
TE 080	WLL 8 t	90	32	0,701	0,670
TE 100	WLL 10 t	91	35	0,843	0,814

DT Round slings

DT ROUND SLINGS WITH DOUBLE SLEEVE



cross section of a DT roundsling sleeve



Type	WLL	Sleeve width (mm)	Round sling diameter	Weight of round sling 0,5 m effective length (kg)	Weight per 0,5 m extra (kg)
DT 010	WLL 1 t	42	12	0,143	0,121
DT 020	WLL 2 t	47	18	0,213	0,190
DT 030	WLL 3 t	58	20	0,314	0,284
DT 040	WLL 4 t	66	22	0,392	0,360
DT 050	WLL 5 t	72	28	0,478	0,441
DT 060	WLL 6 t	77	30	0,586	0,546
DT 080	WLL 7 t	82	32	0,737	0,696
DT 100	WLL 8 t	94	35	0,907	0,860

TLX Round Slings with Techlon® Protective Sleeve Made of Polyester



Material: The construction of a sling is divided into the core and a protection sleeve. The core is made out of polyester (PES) fibres. The protection sleeve is made out of Techlon (PES). Due to the special rip and weave structure, Techlon is significantly more resistance to abrasion than standard polyester sleeve.

Physical properties

Specific Gravity (g/cm ³)	:	1,38
Elongation at WLL (in %)	:	3 - 4
Usable at temperature	:	-40°C - +100°C
Moisture regain %	:	< 0,5
Resistance to mineral Acid*	:	Good
Resistance to Alkalis*	:	Poor

* Always consult the producer.

Application: Techlon (TLX) round slings are for general use for lifting loads from WLL 1 ton up to 150 ton. (straight lift).

For the standard assortment we refer to the enclosed product sheets.

Standards:

- Techlon round slings comply with the Machinery Directive 2006/42/EG
- Techlon round slings have a CE-mark, according to the Machinery Directive requirements. (Europe).
- Techlon round slings comply with NEN-EN 1492-2 (Europe), BS 3481/part2-1983 safety factor 6:1 (middle east, Asia), AS 4497.1-1997 (Australia), OSHA /AS ME B30.9 (USA)

Type TLX Capacity of Premium Round Slings

Type	TLX																			
	120	150	200	250	300	350	400	450	500	550	600	650	700	750	800	850	900	950	1000	1200
WLL	12 t	15 t	20 t	25 t	30 t	35 t	40 t	45 t	50 t	55 t	60 t	65 t	70 t	75 t	80 t	85 t	90 t	95 t	100 t	120 t
Sleeve width	110 mm	110 mm	132 mm	132 mm	160 mm	160 mm	160 mm	180 mm	180 mm	180 mm	220 mm	220 mm	220 mm	320 mm	320 mm	320 mm	320 mm	320 mm	320 mm	320 mm
Core diameter	39 mm	46 mm	52 mm	60 mm	65 mm	67 mm	73 mm	78 mm	86 mm	90 mm	95 mm	98 mm	101 mm	105 mm	108 mm	112 mm	116 mm	120 mm	123 mm	140 mm
EWL in mtr	kg																			
1	2,7	3,6	4,6	6	6,5	7,8	-	-	-	-	-	-	-	-	-	-	-	-	-	-
2	5,3	7	9	11,7	12,9	15,4	17,1	20	22,6	25,1	27	29,5	31,2	-	-	-	-	-	-	-
3	7,9	10,4	13,5	17,5	19,2	23	25,5	29,9	33,7	37,5	40,3	44	46,6	55	57,7	61,8	64,5	68,6	71,3	97,1
4	10,5	13,8	17,9	23,3	25,5	30,5	33,9	39,8	44,8	49,8	53,6	58,6	62	73,2	76,8	82,2	85,8	91,2	106,7	129,3
5	13	17,2	22,3	29,1	31,8	38,1	42,3	49,6	55,9	62,2	66,9	73,2	77,4	91,3	95,9	102,6	107,2	113,9	118,4	161,5
6	15,6	20,6	26,7	34,9	38,1	45,7	50,7	59,5	67	74,6	80,2	87,7	92,8	109,5	114,9	112,9	128,5	136,6	142	193,6
7	18,2	24,1	31,2	40,6	44,5	53,3	59,1	69,4	78,2	87	93,5	102,3	108,2	127,7	134	143,5	149,8	159,3	165,6	225,8
8	20,8	27,5	35,6	46,4	50,8	60,9	67,6	79,2	89,3	99,4	106,8	116,9	123,6	145,8	153,1	163,9	171,1	182	189,2	258
9	23,3	30,9	40	52,2	57,1	68,4	76	89,1	100,4	111,7	120,1	131,4	139	164	172,1	184,3	192,5	204,7	212,8	290,2
10	25,9	34,3	44,4	58	63,4	76	84,4	99	111,5	124,1	133,4	146	154,4	182,2	191,2	204,8	213,8	227,4	236,4	322,3
11	28,5	37,7	48,9	63,8	69,7	83,6	92,8	108,8	122,7	136,5	146,7	160,5	169,8	200,4	210,3	225,2	235,1	250	260	354,5
12	31,1	41,1	53,3	69,5	76,1	91,2	101,2	118,7	133,8	148,9	160	175,1	185,2	218,5	229,4	245,6	256,5	272,7	283,6	386,7
13	33,6	44,5	57,7	75,3	82,4	98,7	109,6	128,5	144,9	161,3	173,3	189,7	200,6	236,7	248,4	266,1	277,8	295,4	307,2	418,9
14	36,2	47,9	62,1	81,1	88,7	106,3	118,1	138,4	156	173,6	186,6	204,2	216	254,9	267,5	286,5	299,1	318,1	330,7	451
15	38,8	51,4	66,6	86,9	95	113,9	126,5	148,3	167,1	186	199,9	218,8	231,4	273	286,6	306,9	320,5	340,8	354,3	483,2
16	41,3	54,8	71	92,7	101,3	121,5	134,9	158,1	178,3	198,4	213,2	233,3	246,8	291,2	305,7	327,3	341,8	363,5	377,9	515,4
17	43,9	58,2	75,4	98,4	107,7	129,1	143,3	168	189,4	210,8	226,5	247,9	262,2	309,4	324,7	347,8	363,1	386,2	401,5	547,6
18	46,5	61,6	79,8	104,2	114	136,6	151,7	177,9	200,5	223,2	239,8	262,5	277,6	327,5	343,8	368,2	384,4	408,8	425,1	579,8
19	49,1	65	84,3	110	120,3	144,2	160,2	187,7	211,6	235,5	253,1	277	293	345,7	362,9	388,6	405,8	431,5	448,7	611,9
20	51,6	68,4	88,7	115,8	126,6	151,8	168,6	197,6	222,8	247,9	266,4	291,6	308,4	363,9	381,9	409	427,1	454,2	472,3	644,1
Extra per mtr. working length	2,6	3,4	4,4	5,8	6,3	7,6	8,4	9,9	11,1	12,4	13,3	14,6	15,4	18,2	19,1	20,4	21,3	22,7	23,6	30

*TLX round slings up to 150 t on request.

Premium Round slings • Type TLX with Techlon® protective sleeve made of polyester

The high-tech polyester round sling

according DIN EN 1492-2

TLX is a high tech -PES- round sling from the Unitex Group. Due to the special rip and weave structure, the Techlon sleeve is significantly more resistant to abrasion than a standard polyester sleeve.

The TLX is fitted with an extremely strong reinforced label.

- Due to the special rip and weave structure, the Techlon sleeve is significantly more resistant to abrasion than a standard polyester sleeve.
- Highly compact and stable sleeve. Optimal use and reduced wear.
- WLL printed on the sleeve continuously and additional sewn in WLL stripes for easy identification.
- Extremely strong reinforced label.
- According to the Machinery Directive 2006/42/EG.
- Color coding according to EN 1492-2.
- Stripe coded, each stripe equals 1 ton of vertical lifting capacity (up to 10 ton).
- WLL printed on the sleeve continuously (up to 10 ton)
- Special warp. The new type of warp gives also an extra resistance against abrasion
- TLX round slings offers a substantial longer service life compared to standard round slings.
- The more compact sleeve results in a better fit around the crane hook.



TLX round slings are being produced up to **150 ton WLL** (Lloyds approval up to WLL 115 T.)

Type	WLL	Sleeve width (mm)	Round sling diameter	Weight of round sling 0,5 m effective length (kg)	Weight per 0,5 m extra (kg)
TLX 010	WLL 1 t	41	12	0,149	0,125
TLX 020	WLL 2 t	52	18	0,236	0,206
TLX 030	WLL 3 t	53	20	0,320	0,288
TLX 040	WLL 4 t	69	22	0,423	0,382
TLX 050	WLL 5 t	76	28	0,501	0,457
TLX 060	WLL 6 t	80	30	0,612	0,564
TLX 080	WLL 7 t	90	32	0,782	0,728
TLX 100	WLL 8 t	96	35	0,941	0,884



Protection Sleeve

PVC PROTECTION SLEEVE Type BS - BL for round slings and lifting slings

Type	Diameter (mm)	Width (mm)	For lifting belts (mm)	For round slings over	
				(1) strand	(2) strands
BS50BL	38	60	30 - 50	1 - 4 t	1 - 3 t
BS60BL	50	80	60	5 - 8 t	4 - 5 t
BS75BL	63	100	75 - 100		5 - 8 t
BS100BL	76	120		10 t	10 t
BS150BL	100	160	120 - 150	12 - 30 t	12 - 20 t
BS180BL	127	200	180	35 - 50 t	25 - 30 t
BS200BL	150	235	200	55 - 60 t	35 - 45 t
BS300BL	200	315	240 - 300	65 - 100 t	50 - 70 t



1: PU-impregnated conduits, type BS - BL, blue

ULTRALIFT ROUND SLING

Material: The construction of a round sling is divided into the load bearing core and the protection sleeve. The Ultralift Round slings is always made out of high performance fibres such as Dyneema® which makes the sling very light in weight even up to 2,5 times lighter in compare to Polyester en 8 times in compare to Steel based slings. The **Ultralift LD (ULLD)** has a protection sleeve made out off 100% Dyneema® This material is extremely abrasion resistant and therefore suitable for for heavy lift applications.

Properties:

Dyneema® is a High Modulus PolyEthylene Fibre (HMPE), that offers maximum strength combined with minimum weight.

Fysical properties

Specific Gravity (g/cm ³)	:	0,97
Elongation at WLL (in %)	:	0,5
Elongation in use	:	Similar to wire rope slings.
Weight reduction in %	:	Compared to wire rope slings; < 80% Compared to polyester based slings; < 59 %
Usable at temperature	:	-50°C-+60°C
Effects on Chemical exposure*	:	Excellent on water, moisture, very resistant against chemicals and micro organism. Good resistance to acid and alkali.
Effects on Chemical exposure*	:	0,0

* Always consult the producer.



Dyneema® is a registered trademark of Royal DSM N.V.

Application:

The Ultralift LD Round Sling with the light duty (UPLD) Dyneema® based protection sleeve is developed for heavy lift applications were abrasion and flexibility is required.

The Ultralift LD Round Slings are exceptionally suitable for repetitive lifting jobs. Due to the maximum strength combined with the minimum weight, cost reductions will be achieved by spending less hours spend on rigging, less workers to rig, less back and hand injuries, a.o.

Standards:

- ULTRALIFT round slings comply with the Machinery Directive 2006/42/EG
- ULTRALIFT have a CE -mark, according the Machinery Directive requirements.
- Each ULTRALIFT round sling is preloaded 2 times the WLL , before delivery.
- A technical dossier is composed and validated by an independent authorized body (A.I.B. Vincotte and Lloyds).



ULTRALIFT-COISLING WITH AN ULTRAPROTECT "HEAVY DUTY" SLEEVE (ULNG)

Material: The Coil Sling NG consists of two parts: The ULTRALIFT round sling as a perfect round sling with a high abrasion resistant cover made of dyneema®. (upld). over both legs an ULTRAPROTECT heavy duty protection sleeve is placed. The ULTRAPROTECT (UPHD) protection sleeve is extremely cut- and abrasion resistant.

Application:

This patented ULTRALIFT coil sling is especially developed for lifting coils and loads which are heavy and sharp.

The benefits of this concept are:

- In case of severe damages the protection sleeve can be replaced easily, without replacing the ULTRALIFT round sling.
- easy handling, due to the size of the ULTRALIFT round sling that fits perfectly into the hook
- The total weight of the ULTRALIFT coil sling NG is extremely low.
- The lifetime of the ulld will be very long, because of the dyneema based cover.
- discharge indicator on the ULTRAPROTECT protection sleeve. (red marker yarns).

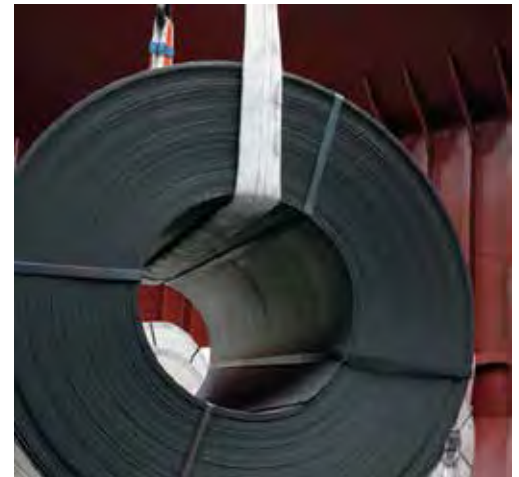

Dyneema® is a registered trademark of Royal DSM N.V.

WEIGHT of Ultra Lift • ULCS round slings • UPHD with protective hose with Dyneema®

Type		ULCS				
		ULCS100	ULCS150	ULCS200	ULCS250	ULCS300
WLL		10 t	15 t	20 t	25 t	30 t
Sleeve width actual ULLD Roundsling		75 - 85mm	90-100 mm	90-100 mm	115-125 mm	115-125 mm
Sleeve width extra UPHD protection sleeve actual Roundsling		115-125mm	145-155mm	145-155mm	175 -185mm	175-185mm
L in mtr	Length UPHD protection Sleeve	kg				
2,5	1,9	4,9	6,2	6,4	8,6	9,2
3	2,4	5,9	7,4	7,7	10,3	11
3,5	2,9	6,9	8,7	9,1	12	12,9
4	3,4	7,9	9,9	10,5	13,7	14,7
4,5	3,9	8,8	11,2	11,8	15,5	16,5
5	4,4	9,8	12,4	13,2	17,2	18,4
5,5	4,9	10,8	13,7	14,6	18,9	20,2
6	5,4	11,8	14,9	15,9	20,6	22,1
6,5	5,9	12,7	16,1	17,3	22,4	23,9
7	6,4	13,7	17,4	18,7	24,1	25,8
7,5	6,9	14,7	18,6	20,0	25,8	27,6
8	7,4	15,7	19,9	21,4	27,5	29,5
8,5	7,9	16,7	21,1	22,7	29,3	31,3
9	8,4	17,6	22,4	24,1	31	33,1
9,5	8,9	18,6	23,6	25,5	32,7	35
10	9,4	19,6	24,8	26,8	34,4	36,8

ULTRALIFT • ULLD round slings made of Dyneema® fibers

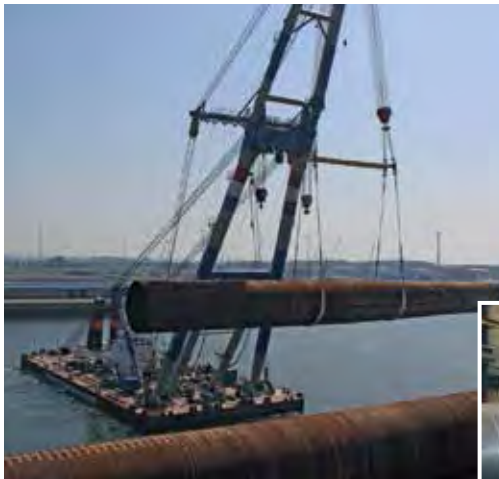

ULTRALIFT LD Round slings are produced out of a Dyneema® yarn and fully Comply to the machinery directive 2006/42/EG

- ULLD Round slings are suitable for precision lift due to the low elongation
- Low weight (2,5 times lighter than PES, and min 8 times lighter compared to steel wire ropes)
- extremely high abrasion resistance



Dyneema®
is a registered
trademark of
Royal DSM N.V.

WEIGHT of Ultra Lift by Unitex® - ULLD round slings made of Dyneema® fibers

Type	ULLD																					
	0020	0030	0040	0050	0060	0080	0100	0150	0200	0250	0300	0400	0500	0600	0700	0800	0900	1000	1200	1400	1600	1800
WLL	2 t	3 t	4 t	5 t	6 t	8 t	10 t	15 t	20 t	25 t	30 t	40 t	50 t	60 t	70 t	80 t	90 t	100 t	120 t	140 t	160 t	180 t
Sleeve type 0,5 up to 2,0 Mtr	73 mm	73 mm	83 mm	83 mm	98 mm	98 mm	123 mm	-----														
Sleeve type from 2 mtr and up	63 mm	63 mm	73 mm	73 mm	73 mm	83 mm	98 mm	-----														
Sleeve width	-----						98 mm	98 mm	133 mm	133 mm	133 mm	183 mm	183 mm	183 mm	183 mm	228 mm	228 mm	283 mm	283 mm	343 mm	343 mm	
Core diameter	-----						30 mm	34 mm	40 mm	44 mm	48 mm	71 mm	75 mm	87 mm	90 mm	94 mm	100 mm	108 mm	116 mm	125 mm	132 mm	
EWL in mtr	Weight (kg)																					
0,5	0,38	0,40	0,56	-	-	-	-	-	-	-	-	-	-	-	-	-	-	-	-	-	-	-
1	0,66	0,71	0,98	1,04	1,09	1,31	1,56	-	-	-	-	-	-	-	-	-	-	-	-	-	-	-
1,5	0,95	1,01	1,41	1,48	1,56	1,88	2,24	-	-	-	-	-	-	-	-	-	-	-	-	-	-	-
2	1,23	1,31	1,83	1,93	2,04	2,45	2,92	-	-	-	-	-	-	-	-	-	-	-	-	-	-	-
2,5	1,40	1,51	1,81	1,94	2,07	2,81	3,28	4,2	4,8	6,2	6,8	8,2	13,1	14,1	17,2	18,9	20,4	-	-	-	-	-
3	1,66	1,79	2,15	2,30	2,46	3,34	3,90	4,9	5,7	7,3	8	9,6	15,4	16,6	20,4	22,3	24,2	32,6	33,6	41,2	46,9	51
3,5	1,93	2,07	2,49	2,67	2,85	3,87	4,52	5,7	6,5	8,4	9,3	11	17,7	19,2	23,5	25,8	27,9	37	38,7	47	53,7	58,5
4	2,19	2,35	2,82	3,03	3,24	4,41	5,14	6,4	7,3	9,5	10,5	12,5	20	21,7	26,7	29,2	31,7	41,4	43,9	52,9	60,5	66
4,5	2,45	2,64	3,16	3,40	3,63	4,94	5,76	7,1	8,2	10,7	11,7	13,9	22,4	24,2	29,8	32,7	35,4	45,9	49	58,8	67,3	73,4
5	2,71	2,92	3,50	3,76	4,03	5,47	6,39	7,8	9	11,8	13	15,4	24,7	26,7	33	36,1	39,2	50,3	54,2	64,6	74	80,9
5,5	2,97	3,20	3,84	4,13	4,42	6	7,01	8,6	9,9	12,9	14,2	16,8	27	29,3	36,1	39,6	42,9	54,8	59,4	70,5	80,8	88,4
6	3,24	3,49	4,18	4,50	4,81	6,53	7,63	9,3	10,7	14	15,4	18,3	29,3	31,8	39,2	43	46,7	59,2	64,5	76,4	87,6	95,9
6,5	3,50	3,77	4,52	4,86	5,20	7,06	8,25	10	11,6	15,1	16,6	19,7	31,6	34,3	42,4	46,5	50,4	63,7	69,7	82,2	94,4	103,3
7	3,76	4,05	4,86	5,23	5,59	7,59	8,87	10,7	12,4	16,2	17,9	21,1	33,9	36,8	45,5	49,9	54,2	68,1	74,8	88,1	101,2	110,8
7,5	4,02	4,33	5,20	5,59	5,98	8,12	9,49	11,4	13,2	17,3	19,1	22,6	36,3	39,4	48,7	53,4	57,9	72,6	80	94	108	118,3
8	4,28	4,62	5,54	5,96	6,38	8,66	10,11	12,2	14,1	18,4	20,3	24	38,6	41,9	51,8	56,9	61,6	77	85,1	99,8	114,8	125,8
8,5	4,55	4,90	5,88	6,32	6,77	9,19	10,74	12,9	14,9	19,5	21,5	25,5	40,9	44,4	55	60,3	65,4	81,5	90,3	105,7	121,6	133,2
9	4,81	5,18	6,22	6,69	7,16	9,72	11,36	13,6	15,8	20,6	22,8	26,9	43,2	46,9	58,1	63,8	69,1	85,9	95,4	111,6	128,3	140,7
9,5	5,07	5,47	6,56	7,06	7,55	10,25	11,98	14,3	16,6	21,7	24	28,3	45,5	49,5	61,3	67,2	72,9	90,3	100,6	117,5	135,1	148,2
10	5,33	5,75	6,90	7,42	7,94	10,78	12,60	15,1	17,5	22,8	25,2	29,8	47,9	52	64,4	70,7	76,6	94,8	105,7	123,3	141,9	155,6
11	5,86	6,31	7,58	8,15	8,73	11,84	13,84	16,5	19,1	25	27,7	32,7	52,5	57	70,7	77,6	84,1	103,7	116	135,1	155,5	170,6
12	6,38	6,88	8,26	8,88	9,51	12,91	15,09	18	20,8	27,3	30,1	35,5	57,1	62,1	77	84,5	91,6	112,6	126,3	146,8	169,1	185,5
13	6,90	7,44	8,94	9,62	10,29	13,97	16,33	19,4	22,5	29,5	32,6	38,4	61,8	67,1	83,3	91,4	99,1	121,5	136,6	158,5	182,6	200,5
14	7,43	8,01	9,62	10,35	11,08	15,03	17,57	20,8	24,2	31,7	35	41,3	66,4	72,2	89,6	98,3	106,6	130,3	147	170,3	196,2	215,4
15	7,95	8,58	10,30	11,08	11,86	16,09	18,81	22,3	25,9	33,9	37,5	44,2	71	77,2	95,9	105,2	114,1	139,2	157,3	182	209,8	230,4
16	8,48	9,14	10,98	11,81	12,65	17,16	20,06	23,7	27,6	36,1	40	47,1	75,7	82,3	102,2	112,1	121,6	148,1	167,6	193,8	223,3	245,3
17	9	9,71	11,65	12,54	13,43	18,22	21,30	25,2	29,3	38,3	42,4	50	80,3	87,3	108,5	119	129,1	157	177,9	205,5	236,9	260,3
18	9,52	10,27	12,33	13,27	14,21	19,28	22,54	26,6	31	40,5	44,9	52,8	84,9	92,4	114,7	125,9	136,6	165,9	188,2	217,2	250,5	275,2
19	10,05	10,84	13,01	14,01	15	20,34	23,79	28,1	32,6	42,8	47,3	55,7	89,6	97,4	121	132,8	144,1	174,8	198,5	229	264,1	290,2
20	10,57	11,40	13,69	14,74	15,78	21,41	25,03	29,5	34,3	45	49,8	58,6	94,2	102,5	127,3	139,8	151,6	183,7	208,8	240,7	277,6	305,1

Round sling connecting links



WEB SLING CONNECTING LINK, SERIE 191 (ACCORDING TO EN1677-1)

Chain Size	WLL	A (mm)	B (mm)	C (mm)	D (mm)	LU (mm)	Weight (kg)
7/8-8	2 t	10,5	24	40	20	62	0,32
10-8	3,15 t	12	28	50	25	78	0,6
13-8	5,3 t	17	33	60	30	97	1,1
16-8	8 t	21	42	75	36	118	2,1

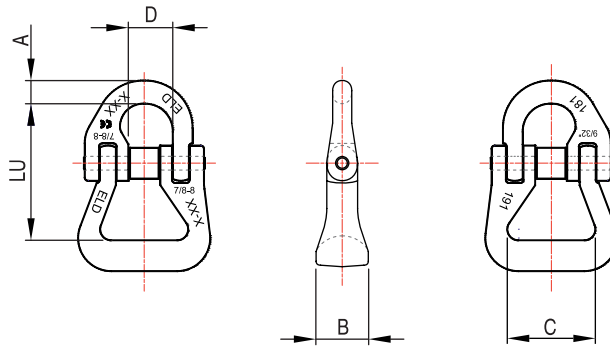

ROUND SLING HOOK Type CJ • GK 8

Type	WLL	A (mm)	B (mm)	C (mm)	D (mm)	G (mm)	H (mm)	P (mm)	T (mm)	Weight (kg)
CJ 01	1 t	78	123	12	41	17	20	16	31	0,7
CJ 02	2 t	91	148	19	55	21	26	17	40	1,2
CJ 03	3 t	113	175	21	55	25	32	25	50	2,2
CJ 04	4 t	133	223	40	70	36	40	36	59,5	4,5
CJ 05	5 t	133	223	40	70	36	40	36	59,5	4,5
CJ 06	6 t	133	223	40	70	36	40	36	59,5	4,5
CJ 08	8 t	185	317	50	100	45	63	55	80	12,5
CJ 10	10 t	185	317	50	100	45	63	55	80	12,5

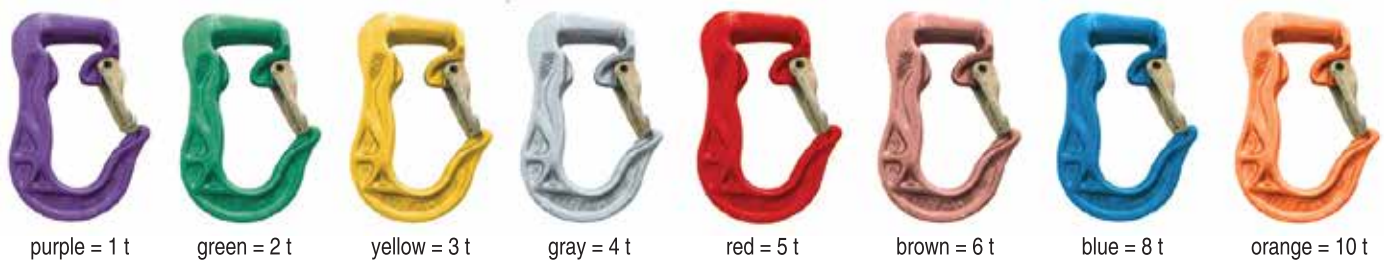
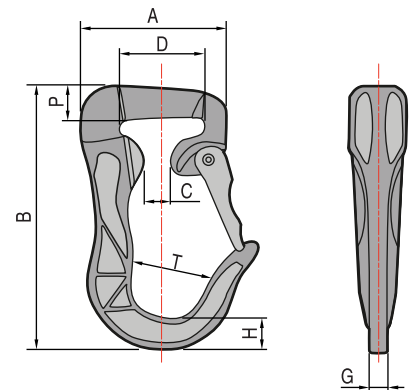

บริษัท ไทแทน เซอร์วิส จำกัด

1/19 หมู่ 1 ต.พิมพา อ.บางปะกง จ. ฉะเชิงเทรา 24180 ประเทศไทย

Tel. : 038-989-373 ถึง 76 Fax. : 038-989-377 HOTLINE : 063-273-1222

E-mail : info.titanservice@gmail.com Website. www.titanservice.co.th

Line : @titanservice เลขประจำตัวผู้เสียภาษี 0245554000604

Facebook.comTitanservicecompany