

General Catalogue



Web Slings Round Slings & lashings



Height Safety Products



Lifting Clamps & Equipment



Chains & Fittings



Protection materials



Contents Catalogue

Web Slings Round Slings & lashings ————— Page 3

Protection Materials ————— Page 57

Height Safety Products ————— Page 72

Lifting Clamps & Equipment ————— Page 86

Chains & Fittings ————— Page 122









Contents

WLL table	Page	4 - 5
Unitex introduction	Page	6
Web slings Roundslings Information	Page	7 - 8
MC web slings	Page	9
MCEE / MCED endless web slings	Page	10
MCDD / MCDDS web slings with triangles	Page	11
MCDD/ MCDDS Triangle specifications	Page	12
TE/ DT Round slings	Page	13
TLX Premium round slings	Page	14
UL Information	Page	16
ULLD Round slings	Page	17 - 18
ULCS coil slings	Page	19
TLX Information	Page	20
TLX round slings	Page	21 - 22
TDQ Information	Page	23
TDQ 4-layer web slings	Page	24
TDQDD 4-layer web slings	Page	25
TDQDD Triangle specifications	Page	26
TDQDDS 4-layer web slings	Page	27
TDQDDS Triangle specifications	Page	28
Lashing information	Page	29 - 34
25mm lashing systems	Page	35 - 36
35mm lashing systems	Page	37 - 38
50mm lashing systems	Page	39 - 40
50mm lashing 2000/4000 daN systems	Page	41 - 42
50mm lashing 2500/5000 daN systems	Page	43 - 44
75/100 mm lashing systems	Page	45
Lashing hooks	Page	46
Ratchets	Page	47
One Way Lashing	Page	48 - 49
Unitex Anti slide matting	Page	50 - 51
TURTLE MAX Timber Lashing System	Page	52 - 54
AirMaxx Dunnagebags	Page	55 - 56

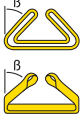
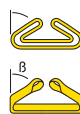
WLL table

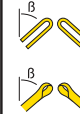
WORKING LOAD LIMIT (WLL) POLYESTER





Wll capacity table for webbing and roundsling

Colourcode according to EN 1492-1/2	Working Load Limits with 1 webbing sling or roundsling							Working Load Limits with 2 webbing slings or roundslings				
	straight lift	choked lift	*B		*B		*B		*B		*B	
			0° - 7°	7° - 45°	45° - 60°	7° - 45°	45° - 60°	7° - 45°	45° - 60°	7° - 45°	45° - 60°	
												
Factor	1	0,8	2	1,4	1	0,7	0,5	1,4	1	1,12	0,8	
WLL in t												
WLL 1 t	1,00	0,80	2,00	1,40	1,00	0,70	0,50	1,40	1,00	1,12	0,80	
WLL 2 t	2,00	1,60	4,00	2,80	2,00	1,40	1,00	2,80	2,00	2,24	1,60	
WLL 3 t	3,00	2,40	6,00	4,20	3,00	2,10	1,50	4,20	3,00	3,36	2,40	
WLL 4 t	4,00	3,20	8,00	5,60	4,00	2,80	2,00	5,60	4,00	4,48	3,20	
WLL 5 t	5,00	4,00	10,00	7,00	5,00	3,50	2,50	7,00	5,00	5,60	4,00	
WLL 6 t	6,00	4,80	12,00	8,40	6,00	4,20	3,00	8,40	6,00	6,72	4,80	
WLL 8 t	8,00	6,40	16,00	11,20	8,00	5,60	4,00	11,20	8,00	8,96	6,40	
WLL 10 t	10,00	8,00	20,00	14,00	10,00	7,00	5,00	14,00	10,00	11,20	8,00	
WLL 12 t	12,00	9,60	24,00	16,80	12,00	8,40	6,00	16,80	12,00	13,44	9,60	
WLL 15 t	15,00	12,00	30,00	21,00	15,00	10,50	7,50	21,00	15,00	16,80	12,00	
WLL 20 t	20,00	16,00	40,00	28,00	20,00	14,00	10,00	28,00	20,00	22,40	16,00	
WLL 25 t	25,00	20,00	50,00	35,00	25,00	17,50	12,50	35,00	25,00	28,00	20,00	
WLL 30 t	30,00	24,00	60,00	42,00	30,00	21,00	15,00	42,00	30,00	33,60	24,00	
WLL 40 t	40,00	32,00	80,00	56,00	40,00	28,00	20,00	56,00	40,00	44,80	32,00	
WLL 50 t	50,00	40,00	100,00	70,00	50,00	35,00	25,00	70,00	50,00	56,00	40,00	
WLL 60 t	60,00	48,00	120,00	84,00	60,00	42,00	30,00	84,00	60,00	67,20	48,00	
WLL 70 t	70,00	56,00	140,00	98,00	70,00	49,00	35,00	98,00	70,00	78,40	56,00	
WLL 80 t	80,00	64,00	160,00	112,00	80,00	56,00	40,00	112,00	80,00	89,60	64,00	
WLL 90 t	90,00	72,00	180,00	126,00	90,00	63,00	45,00	126,00	90,00	100,80	72,00	
WLL 100 t	100,00	80,00	200,00	140,00	100,00	70,00	50,00	140,00	100,00	112,00	80,00	
WLL 110 t	110,00	88,00	220,00	154,00	110,00	77,00	55,00	154,00	110,00	123,20	88,00	
WLL 115 t	115,00	92,00	230,00	161,00	115,00	80,50	57,50	161,00	115,00	128,80	92,00	

WLL table

WORKING LOAD LIMIT (WLL) *ULTRALIFT*

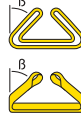
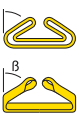
WLL capacity table for *ULTRALIFT* roundslings

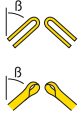
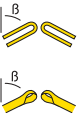
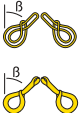
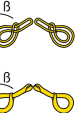
	Working Load Limits with 1 webbing sling or roundsling							Working Load Limits with 2 webbing slings or roundslings			
	straight lift	choked lift	*B		*B		*B	*B		*B	
			0° - 7°	7° - 45°	45° - 60°	7° - 45°		45° - 60°	7° - 45°	45° - 60°	
											
Factor	1	0,8	2	1,4	1	0,7	0,5	1,4	1	1,12	0,8
WLL in t											
WLL 10 t	10,00	8,00	20,00	14,00	10,00	7,00	5,00	14,00	10,00	11,20	8,00
WLL 12 t	12,00	9,60	24,00	16,80	12,00	8,40	6,00	16,80	12,00	13,44	9,60
WLL 15 t	15,00	12,00	30,00	21,00	15,00	10,50	7,50	21,00	15,00	16,80	12,00
WLL 20 t	20,00	16,00	40,00	28,00	20,00	14,00	10,00	28,00	20,00	22,40	16,00
WLL 25 t	25,00	20,00	50,00	35,00	25,00	17,50	12,50	35,00	25,00	28,00	20,00
WLL 30 t	30,00	24,00	60,00	42,00	30,00	21,00	15,00	42,00	30,00	33,60	24,00
WLL 40 t	40,00	32,00	80,00	56,00	40,00	28,00	20,00	56,00	40,00	44,80	32,00
WLL 50 t	50,00	40,00	100,00	70,00	50,00	35,00	25,00	70,00	50,00	56,00	40,00
WLL 60 t	60,00	48,00	120,00	84,00	60,00	42,00	30,00	84,00	60,00	67,20	48,00
WLL 70 t	70,00	56,00	140,00	98,00	70,00	49,00	35,00	98,00	70,00	78,40	56,00
WLL 80 t	80,00	64,00	160,00	112,00	80,00	56,00	40,00	112,00	80,00	89,60	64,00
WLL 90 t	90,00	72,00	180,00	126,00	90,00	63,00	45,00	126,00	90,00	100,80	72,00
WLL 100 t	100,00	80,00	200,00	140,00	100,00	70,00	50,00	140,00	100,00	112,00	80,00
WLL100 t	100,00	80,00	200,00	140,00	100,00	70,00	50,00	140,00	100,00	112,00	80,00
WLL120 t	120,00	96,00	240,00	168,00	120,00	84,00	60,00	168,00	120,00	134,40	96,00
WLL140 t	140,00	112,00	280,00	196,00	140,00	98,00	70,00	196,00	140,00	156,80	112,00
WLL160 t	160,00	128,00	320,00	224,00	160,00	112,00	80,00	224,00	160,00	179,20	128,00
WLL180 t	180,00	144,00	360,00	252,00	180,00	126,00	90,00	252,00	180,00	201,60	144,00
WLL200 t	200,00	160,00	400,00	280,00	200,00	140,00	100,00	280,00	200,00	224,00	160,00

Unitex introduction

UNITEX

The Unitex group of companies are manufacturers of textile web- and round slings and lashings with a history of 100 years in the textile industry.

The 100 years of experience and know how is our major asset for innovation, engineering and development of new products. Therefore we are able to manage innovative projects in close co-operation with both costumers, suppliers and third parties. With a resource of qualified personnel we are able to build project teams around any market demand. Furthermore we are one of the few manufacturers to produce slings right through from the basic yarn to the finished products. Because of this, the technical ability and development expertise Unitex constantly is in search for and implementing improvements.

With testing facilities and quality procedures we assure that all processes and products are controlled to comply with applicable standards and specifications. Our specialized equipment subject samples to every conceivable test. Extension, surface abrasion, chemical exposure. Tenacity, temperature and load performance profiles are just some of the test undertaken. The standard and properties claimed for every product are established and approved by our highly qualified laboratory staff.



Web slings Round slings

Information

4) Way of use and handling

The European Norm has given each capacity in the EN 1492/1-2 a specific colour. This to identify the capacity of webslings and roundslings easily and clearly

- WLL 1,0 t
- WLL 2,0 t
- WLL 3,0 t
- WLL 4,0 t
- WLL 5,0 t
- WLL 6,0 t
- WLL 8,0 t
- WLL 10,0 t and >10 t



To make sure the stitching of the eye of a websling wont break open, the angle of opened eye of the websling shouldn't be more than 20 degrees when it is put into a cranehook

The following rule has to be followed:

You are on the safe side as the eye of the websling at least 3,5 x as long is as the thickness of the cranehook

$$L2 > = b \times 3,5$$

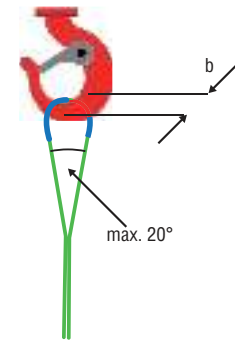

Be careful: sharp edges will not only damage lifting equipment, but can also lead to accidents

For this reason:

The corner radius ,r' must always to be bigger than the strength ,d' of the lifting equipment. If loads with sharp edges have to be lifted corner protection definitely has to be used. For example Purtectra or Ultra Protect corner protection solutions from Unitex.

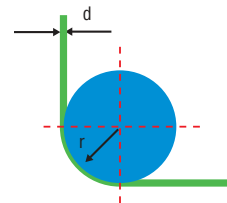

Warning:
Due to slipping of the load, both corner protection systems, Purtectra and Ultra Protect, can be damaged

Lifting equipment made of polyester fibres with their marked capacity can be used in temperatures between -40 degrees and +100 degrees C.

If they are being used in connection with chemicals it is absolutely necessary to contact the manufacturer beforehand for permission.

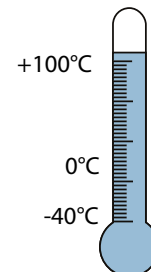

Web slings Roundslings

Information

1) EN-Standards and Machinery Directives

For all European manufacturers are the technical demands and the references how to produce textile lifting equipment like roundslings and webslings summarized in the EN 1492-1 (Webslings) and the EN 1492-2 (Roundslings). Additionally the textile lifting equipment is encoded with the CE mark according the Machinery Directory 2006/42/EG



2) Testing and Maintenance

To guarantee a safe way of using the textile lifting equipment they must be tested at least one time per year or according the latest publications of the standard or local guidelines.

The operator of the equipment has to arrange independently of predetermining operation conditions several test intervals. These tests may only be done by competent persons. Possible damaged Roundslings/Webslings may only be repaired by the manufacturer or by people who have become the power of attorney to repair from the manufacturer.

To guarantee the quality of our products the standard Webslings and Roundslings are being certified by the AIB Vinchotte (VGS), Berufsgenossenschaft (GS) or Lloyds.



3) Lifting of loads (WLL Capacity table and lifting angle)

If a load with a certain weight has to be lifted, the person who has to coordinate this job has to make sure the correct lifting materials are chosen. Also the number of slings, the capacity and the length has to be defined. It is also to plan the lifting procedure and to make sure that the angle of inclination is not more than 60 degrees (an angle of more than 60 degrees is forbidden!)

The bigger the angle of inclination, the smaller the practical capacity of the lifting equipment.

As a simple rule you can say:

By an angle of inclination up to 45 degrees the chosen lifting equipment can be calculated with only 70% of the original capacity. For example:

$$70\% \text{ of } 2T = 0,7 \times 2T = 1,4T$$

By an angle of inclination up to 60 degrees the chosen lifting equipment can be calculated with only 50% of the original capacity. For example:

$$50\% \text{ of } 2T = 0,5 \times 2T = 1,0T$$

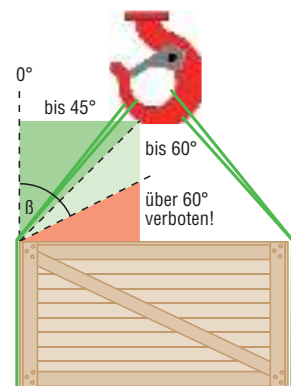

MC web slings

MC WEB SLINGS 2-LAYER



	Type	WLL	Webbing width in mm	Thickness in mm	Eye length 1 m effective length in mm (L ₂)	Eye length 2 m effective length in mm (L ₂)	Eye length 3 m effective length in mm (L ₂)	Standard eye type	Weight 1 meter in kg (L ₁)	Weight 2 meter in kg (L ₁)	Weight 3 meter in kg (L ₁)	Weight each meter extra
	MC30	WLL 1 t	30	7	250	400		type 1	0,25	0,45	0,65	0,20
	MC60	WLL 2 t	60	6	250	400		type 3	0,44	0,79	1,14	0,35
	MC90	WLL 3 t	90	7,5	250	400		type 3	0,71	1,25	1,80	0,55
	MC120	WLL 4 t	120	8		450		type 4		1,67	2,40	0,73
	MC150	WLL 5 t	150	7		550		type 4		2,12	3,06	0,94
	MC180	WLL 6 t	180	7		600		type 4		2,95	4,14	1,20
	MC240	WLL 8 t	240	8			750	type 4			5,25	1,50
	MC300	WLL 10 t	300	7			1000	type 4			6,85	1,97
	MC300	WLL 12 t	300	8			1000	type 4			8,35	2,36

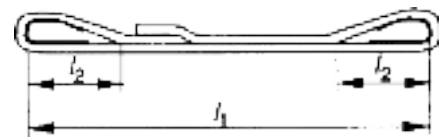
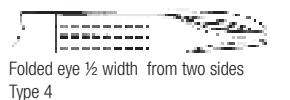
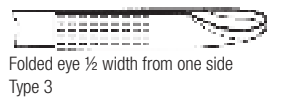
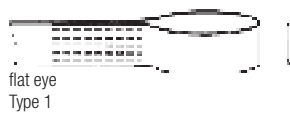

MCEE / MCED endless web slings

MCEE ENDLESS WEB SLINGS SINGLE LAYER



Type	WLL	Webbing width in mm	Thickness in mm	Weight 0,5 meter in kg (L ₁)	Weight 1 meter in kg (L ₁)	Weight 0,5 meter extra in KG
MCEE30	WLL 1 t	30	3,5	0,12	0,21	0,09
MCEE60	WLL 2 t	60	3	0,21	0,38	0,17
MCEE90	WLL 3 t	90	4	0,34	0,60	0,26
MCEE120	WLL 4 t	120	4		0,82	0,35
MCEE150	WLL 5 t	150	3,5		1,06	0,45
MCEE180	WLL 6 t	180	3,5		1,45	0,58
MCEE240	WLL 8 t	240	4		1,84	0,72
MCEE300	WLL 10 t	300	3,5		2,47	0,95
MCEE300	WLL 12 t	300	4		3,14	1,14

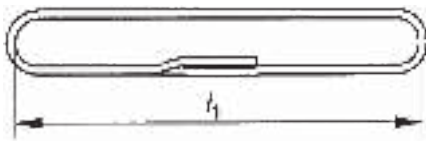

MCED ENDLESS WEB SLINGS 2-LAYER



Type	WLL	Webbing width in mm	Thickness in mm	Weight 0,5 meter in kg (L ₁)	Weight 1 meter in kg (L ₁)	Weight 0,5 meter extra in KG
MCED30	WLL 2 t	30	7	0,22	0,41	0,19
MCED60	WLL 4 t	60	6	0,39	0,73	0,34
MCED90	WLL 6 t	90	7,5	0,62	1,16	0,54
MCED120	WLL 8 t	120	8		1,57	0,72
MCED150	WLL 10 t	150	7		2,02	0,93
MCED180	WLL 12 t	180	7		2,69	1,19
MCED240	WLL 16 t	240	8		3,37	1,48
MCED300	WLL 20 t	300	7		4,5	1,96
MCED300	WLL 24 t	300	8		5,58	2,35

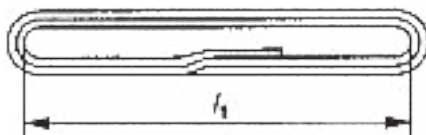









MCDD / MCDDS

web slings with triangles









MCDD 2-LAYER WEB SLINGS WITH TRIANGLES (MALE/MALE)



Type	WLL	Webbing width in mm	Thick-ness in mm	Weight 1 meter in kg (L ₁)	Weight 2 meter in kg (L ₂)	Weight 3 meter in kg (L ₃)	Weight 1 meter extra in KG
 MCDD30	WLL 1 t	30	7	0,62	0,82	1,02	0,20
 MCDD60	WLL 2 t	60	6	1,39	1,74	2,09	0,35
 MCDD90	WLL 3 t	90	7,5	2,78	3,33	3,88	0,55
 MCDD120	WLL 4 t	120	8		4,68	5,41	0,73
 MCDD150	WLL 5 t	150	7		6,19	7,13	0,94
 MCDD180	WLL 6 t	180	7		8,51	9,71	1,20
 MCDD240	WLL 8 t	240	8			16,24	1,50
 MCDD300	WLL 10 t	300	7			21,68	1,97
 MCDD300	WLL 12 t	300	8			22,97	2,36

MCDDS 2-LAYER WEB SLINGS WITH TRIANGLES (MALE/FEMALE)



Type	WLL	Webbing width in mm	Thick-ness in mm	Weight 1 meter in kg (L ₁)	Weight 2 meter in kg (L ₂)	Weight 3 meter in kg (L ₃)	Weight 1 meter extra in KG
 MCDDS30	WLL 1 t	30	7	0,82	1,02	1,22	0,20
 MCDDS60	WLL 2 t	60	6	1,86	2,21	2,56	0,35
 MCDDS90	WLL 3 t	90	7,5	3,63	4,21	4,76	0,55
 MCDDS120	WLL 4 t	120	8		6,11	6,84	0,73
 MCDDS150	WLL 5 t	150	7		8,90	9,84	0,94
 MCDDS180	WLL 6 t	180	7		10,79	11,99	1,20
 MCDDS240	WLL 8 t	240	8			20,45	1,50
 MCDDS300	WLL 10 t	300	7			27,31	1,97

MCDD/ MCDDS

Triangle specifications



TECHNICAL INFORMATION FOR MCDD MALE TRIANGLES

Type	WLL	Width in mm	Q in mm	D in mm	H in mm	E in mm	Weight per piece in kg
DTR/010	WLL 1 t	30	12	45	60	70	0,2

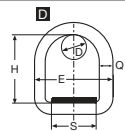

Type	WLL	Width in mm	Q in mm	D in mm	H in mm	E in mm	Weight per Piece in kg
DTR/020	WLL 2 t	60	16	30	80	100	0,5
DTR/030	WLL 3 t	90-100	20	60	120	146	1,1
DTR/040	WLL 4 t	120	23	60	130	179	1,6
DTR/050	WLL 5 t	150	26	90	180	222	2,2
DTR/060	WLL 6 t	180	28	90	180	262	3
DTR/080	WLL 8 t	240	32	100	200	344	5,8
DTR/100	WLL 10 t	300	35	100	250	400	7,9

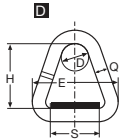

TECHNICAL INFORMATION FOR MCDDS FEMALE TRIANGLES

Typ	WLL	Width in mm	Q in mm	D in mm	H in mm	P in mm	Weight per Piece in kg
DSTR/010	WLL 1 t	30	12	50	100	25	0,4
DSTR/020	WLL 2 t	60	16	40	146	40	1
DSTR/030	WLL 3 t	90-100	20	70	205	55	2
DSTR/040	WLL 4 t	120	23	80	218	55	3,1
DSTR/050	WLL 5 t	150	26	90	300	80	5
DSTR/060	WLL 6 t	180	28	90	284	80	5,4
DSTR/080	WLL 8 t	240	32	120	332	90	10,2
DSTR/100	WLL 10 t	300	35	120	385	100	13,8

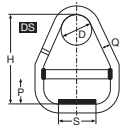

TE/ DT Round slings

TE ROUND SLINGS WITH SINGLE SLEEVE



Type	WLL	Sleeve width in mm	Round sling diameter	Weight of round sling 0,5 m effective length in kg	Weight per 0,5 m extra in kg
TE 010	WLL 1 t	47	12	0,118	0,103
TE 020	WLL 2 t	48	18	0,185	0,170
TE 030	WLL 3 t	54	20	0,264	0,248
TE 040	WLL 4 t	70	22	0,356	0,334
TE 050	WLL 5 t	72	28	0,431	0,407
TE 060	WLL 6 t	74	30	0,528	0,504
TE 080	WLL 8 t	90	32	0,701	0,670
TE 100	WLL 10 t	91	35	0,843	0,814



DT ROUND SLINGS WITH DOUBLE SLEEVE



cross section of a DT roundsling sleeve

Type	WLL	Sleeve width in mm	Round sling diameter	Weight of round sling 0,5 m effective length in kg	Weight per 0,5 m extra in kg
DT 010	WLL 1 t	42	12	0,143	0,121
DT 020	WLL 2 t	47	18	0,213	0,190
DT 030	WLL 3 t	58	20	0,314	0,284
DT 040	WLL 4 t	66	22	0,392	0,360
DT 050	WLL 5 t	72	28	0,478	0,441
DT 060	WLL 6 t	77	30	0,586	0,546
DT 080	WLL 8 t	82	32	0,737	0,696
DT100	WLL 10 t	94	35	0,907	0,860



TLX Premium round slings

TLX round slings +++++

the high tech round sling made from polyester

according DIN EN 1492-2

TLX is a high tech -PES- round sling from the Unitex Group. Due to the special rip and weave structure, the Techlon sleeve is significantly more resistant to abrasion than a standard polyester sleeve. The TLX is fitted with an extremely strong reinforced label.

1. + Due to the special rip and weave structure, the Techlon sleeve is significantly more resistant to abrasion than a standard polyester sleeve.
2. + Highly compact and stable sleeve. Optimal use and reduced wear.
3. + WLL printed on the sleeve continuously and additional sewn in WLL stripes for easy identification.
4. + Extremely strong reinforced label.
5. + According to the Machinery Directive 2006/42/EG.
6. + Color coding according to EN 1492-2.
7. + Stripe coded, each stripe equals 1 ton of vertical lifting capacity (up to 10 ton).
8. + WLL printed on the sleeve continuously (up to 10 ton)
9. + Special warp. The new type of warp gives also an extra resistance against abrasion
10. + TLX round slings offers a substantial longer service life compared to standard round slings.
11. + The more compact sleeve results in a better fit around the crane hook.

TLX round slings are being produced up to **150 ton WLL** (Lloyds approval up to WLL 115 T.)



	Type	WLL	Sleeve width in mm	Round sling diameter	Weight of round sling 0,5 m effective length in kg	Weight per 0,5 m extra in kg
	TLX 010	WLL 1 t	41	12	0,149	0,125
	TLX 020	WLL 2 t	51	18	0,236	0,206
	TLX 030	WLL 3 t	53	20	0,320	0,288
	TLX 040	WLL 4 t	69	22	0,423	0,382
	TLX 050	WLL 5 t	76	28	0,501	0,457
	TLX 060	WLL 6 t	80	30	0,612	0,564
	TLX 080	WLL 8 t	90	32	0,782	0,728
	TLX 100	WLL 10 t	96	35	0,941	0,884

Heavy lift



UL Information

ULTRALIFT ROUND SLING

Material:

The construction of a round sling is divided into the load bearing core and the protection sleeve. The Ultralift Round slings is always made out of high performance fibres such as Dyneema® which makes the sling very light in weight even up to 2,5 times lighter in compare to Polyester en 8 times in compare to Steel based slings. The **Ultralift LD (ULLD)** has a protection sleeve made out off 100% Dyneema® This material is extremely abrasion resistant and therefore suitable for heavy lift applications.

Properties:

Dyneema® is a High Modulus PolyEthylene Fibre (HMPE), that offers maximum strength combined with minimum weight.

Fysical properties

Specific Gravity (g/cm ³)	:	0,97
Elongation at WLL (in %)	:	0,5
Elongation in use	:	Similar to wire rope slings.
Weight reduction in %	:	Compared to wire rope slings; < 80% Compared to polyester based slings; < 59 %
Usable at temperature	:	- 50° C - + 60° C
Effects on Chemical exposure*	:	Excellent on water, moisture, very resistant against chemicals and micro organism. Good resistance to acid and alkali.
Effects on Chemical exposure*	:	0,0

* Always consult the producer.

Application:

The Ultralift LD Round Sling with the light duty (UPLD) Dyneema® based protection sleeve is developed for heavy lift applications where abrasion and flexibility is required.

The Ultralift LD Round Slings are exceptionally suitable for repetitive lifting jobs. Due to the maximum strength combined with the minimum weight, cost reductions will be achieved by spending less hours spend on rigging, less workers to rig, less back and hand injuries, a.o.

Standards:

- *ULTRALIFT* round slings comply with the Machinery Directive 2006/42/EG
- *ULTRALIFT* have a CE -mark, according the Machinery Directive requirements.
- Each *ULTRALIFT* round sling is preloaded 2 times the WLL, before delivery.
- A technical dossier is composed and validated by an independent authorized body (A.I.B. Vincotte and Lloyds).

ULLD Round slings

ULTRALIFT LD

ULTRALIFT LD Round slings are produced out of a Dyneema® yarn and fully Comply to the machinery directive 2006/42/EG

1. **+** : ULLD Round slings are suitable for precision lift due to the low elongation
2. **+** : Low weight (2,5 times lighter than PES, and min 8 times lighter compared to steel wire ropes)



ULTRALIFT LD RONDSLINGS (ULLD)

Weight of a ULTRALIFT LD Round slings

	Type	ULLD0020	ULLD0030	ULLD0040	ULLD0050	ULLD0060	ULLD0080	ULLD0100
	WLL	2 T.	3 t.	4 T.	5 T.	6 T.	8 t.	10 t.
	sleeve type 0,5 up to 2,0 Mtr	73 mm	73 mm	83 mm	83 mm	98 mm	98 mm	123 mm
	Sleeve type from 2 mtr and up	63 mm	63 mm	73 mm	73 mm	73 mm	83 mm	98 mm
length in Mtr		kg	kg	kg	kg	kg	kg	kg
0,5	ULLD	0,38	0,40	0,56				
1	ULLD	0,66	0,71	0,98	1,04	1,09	1,31	1,56
1,5	ULLD	0,95	1,01	1,41	1,48	1,56	1,88	2,24
2	ULLD	1,23	1,31	1,83	1,93	2,04	2,45	2,92
2,5	ULLD	1,40	1,51	1,81	1,94	2,07	2,81	3,28
3	ULLD	1,66	1,79	2,15	2,30	2,46	3,34	3,90
3,5	ULLD	1,93	2,07	2,49	2,67	2,85	3,87	4,52
4	ULLD	2,19	2,35	2,82	3,03	3,24	4,41	5,14
4,5	ULLD	2,45	2,64	3,16	3,40	3,63	4,94	5,76
5	ULLD	2,71	2,92	3,50	3,76	4,03	5,47	6,39
5,5	ULLD	2,97	3,20	3,84	4,13	4,42	6,00	7,01
6	ULLD	3,24	3,49	4,18	4,50	4,81	6,53	7,63
6,5	ULLD	3,50	3,77	4,52	4,86	5,20	7,06	8,25
7	ULLD	3,76	4,05	4,86	5,23	5,59	7,59	8,87
7,5	ULLD	4,02	4,33	5,20	5,59	5,98	8,12	9,49
8	ULLD	4,28	4,62	5,54	5,96	6,38	8,66	10,11
8,5	ULLD	4,55	4,90	5,88	6,32	6,77	9,19	10,74
9	ULLD	4,81	5,18	6,22	6,69	7,16	9,72	11,36
9,5	ULLD	5,07	5,47	6,56	7,06	7,55	10,25	11,98
10	ULLD	5,33	5,75	6,90	7,42	7,94	10,78	12,60
11	ULLD	5,86	6,31	7,58	8,15	8,73	11,84	13,84
12	ULLD	6,38	6,88	8,26	8,88	9,51	12,91	15,09
13	ULLD	6,90	7,44	8,94	9,62	10,29	13,97	16,33
14	ULLD	7,43	8,01	9,62	10,35	11,08	15,03	17,57
15	ULLD	7,95	8,58	10,30	11,08	11,86	16,09	18,81
16	ULLD	8,48	9,14	10,98	11,81	12,65	17,16	20,06
17	ULLD	9,00	9,71	11,65	12,54	13,43	18,22	21,30
18	ULLD	9,52	10,27	12,33	13,27	14,21	19,28	22,54
19	ULLD	10,05	10,84	13,01	14,01	15,00	20,34	23,79
20	ULLD	10,57	11,40	13,69	14,74	15,78	21,41	25,03



ULLD Round slings



ULTRALIFT LD Round slings are produced out of a Dyneema® yarn and fully Comply to the machinery directive 2006/42/EG

1. + : ULLD Round slings are suitable for precision lift due to the low elongation
2. + : Low weight (2,5 times lighter than PES, and min 8 times lighter compared to steel wire ropes)
3. + : extremely high abrasion resistance



ULTRALIFT LD ROUND SLINGS WITH „LIGHT DUTY“ SLEEVE (ULLD)

EWL in mtr	Type	ULLD0015	ULLD0020	ULLD0025	ULLD0030	ULLD0040	ULLD0050	ULLD0060	ULLD0070	ULLD0080	ULLD0090	ULLD0100	ULLD0120	ULLD0140	ULLD0160	ULLD0180	ULLD0200
	W.L.L.	15t	20t	25t	30t	40t	50t	60t	70t	80t	90t	100t	120 t	140 t	160 t	180 t	200 t
	Sleeve width	98 mm	98 mm	133 mm	133 mm	133 mm	183 mm	183 mm	183 mm	213 mm	228 mm	228 mm	283 mm	283 mm	343 mm	343 mm	343 mm
	Core diameter	30 mm	34 mm	40 mm	44 mm	48 mm	71 mm	75 mm	87 mm	90 mm	94 mm	100 mm	108 mm	116 mm	125 mm	132 mm	140 mm
	Weight in kg	Weight in kg	Weight in kg	Weight in kg	Weight in kg	Weight in kg	Weight in kg	Weight in kg	Weight in kg	Weight in kg	Weight in kg	Weight in kg	Weight in kg	Weight in kg	Weight in kg	Weight in kg	Weight in kg
2,5	ULLD	4,2	4,8	6,2	6,8	8,2	13,1	14,1	17,2	18,9	20,4						
3	ULLD	4,9	5,7	7,3	8,0	9,6	15,4	16,6	20,4	22,3	24,2	32,6	33,6	41,2	46,9	51,0	55,1
3,5	ULLD	5,7	6,5	8,4	9,3	11,0	17,7	19,2	23,5	25,8	27,9	37,0	38,7	47,0	53,7	58,5	63,3
4	ULLD	6,4	7,3	9,5	10,5	12,5	20,0	21,7	26,7	29,2	31,7	41,4	43,9	52,9	60,5	66,0	71,5
4,5	ULLD	7,1	8,2	10,7	11,7	13,9	22,4	24,2	29,8	32,7	35,4	45,9	49,0	58,8	67,3	73,4	79,6
5	ULLD	7,8	9,0	11,8	13,0	15,4	24,7	26,7	33,0	36,1	39,2	50,3	54,2	64,6	74,0	80,9	87,8
5,5	ULLD	8,6	9,9	12,9	14,2	16,8	27,0	29,3	36,1	39,6	42,9	54,8	59,4	70,5	80,8	88,4	95,9
6	ULLD	9,3	10,7	14,0	15,4	18,3	29,3	31,8	39,2	43,0	46,7	59,2	64,5	76,4	87,6	95,9	104,1
6,5	ULLD	10,0	11,6	15,1	16,6	19,7	31,6	34,3	42,4	46,5	50,4	63,7	69,7	82,2	94,4	103,3	112,3
7	ULLD	10,7	12,4	16,2	17,9	21,1	33,9	36,8	45,5	49,9	54,2	68,1	74,8	88,1	101,2	110,8	120,4
7,5	ULLD	11,4	13,2	17,3	19,1	22,6	36,3	39,4	48,7	53,4	57,9	72,6	80,0	94,0	108,0	118,3	128,6
8	ULLD	12,2	14,1	18,4	20,3	24,0	38,6	41,9	51,8	56,9	61,6	77,0	85,1	99,8	114,8	125,8	136,7
8,5	ULLD	12,9	14,9	19,5	21,5	25,5	40,9	44,4	55,0	60,3	65,4	81,5	90,3	105,7	121,6	133,2	144,9
9	ULLD	13,6	15,8	20,6	22,8	26,9	43,2	46,9	58,1	63,8	69,1	85,9	95,4	111,6	128,3	140,7	153,1
9,5	ULLD	14,3	16,6	21,7	24,0	28,3	45,5	49,5	61,3	67,2	72,9	90,3	100,6	117,5	135,1	148,2	161,2
10	ULLD	15,1	17,5	22,8	25,2	29,8	47,9	52,0	64,4	70,7	76,6	94,8	105,7	123,3	141,9	155,6	169,4
11	ULLD	16,5	19,1	25,0	27,7	32,7	52,5	57,0	70,7	77,6	84,1	103,7	116,0	135,1	155,5	170,6	185,7
12	ULLD	18,0	20,8	27,3	30,1	35,5	57,1	62,1	77,0	84,5	91,6	112,6	126,3	146,8	169,1	185,5	202,0
13	ULLD	19,4	22,5	29,5	32,6	38,4	61,8	67,1	83,3	91,4	99,1	121,5	136,6	158,5	182,6	200,5	218,3
14	ULLD	20,8	24,2	31,7	35,0	41,3	66,4	72,2	89,6	98,3	106,6	130,3	147,0	170,3	196,2	215,4	234,7
15	ULLD	22,3	25,9	33,9	37,5	44,2	71,0	77,2	95,9	105,2	114,1	139,2	157,3	182,0	209,8	230,4	251,0
16	ULLD	23,7	27,6	36,1	40,0	47,1	75,7	82,3	102,2	112,1	121,6	148,1	167,6	193,8	223,3	245,3	267,3
17	ULLD	25,2	29,3	38,3	42,4	50,0	80,3	87,3	108,5	119,0	129,1	157,0	177,9	205,5	236,9	260,3	283,6
18	ULLD	26,6	31,0	40,5	44,9	52,8	84,9	92,4	114,7	125,9	136,6	165,9	188,2	217,2	250,5	275,2	299,9
19	ULLD	28,1	32,6	42,8	47,3	55,7	89,6	97,4	121,0	132,8	144,1	174,8	198,5	229,0	264,1	290,2	316,3
20	ULLD	29,5	34,3	45,0	49,8	58,6	94,2	102,5	127,3	139,8	151,6	183,7	208,8	240,7	277,6	305,1	332,6

ULCS coil slings

ULTRALIFT-COILSLING WITH AN ULTRAPROTECT "HEAVY DUTY" SLEEVE (ULNG)

The Coil Sling NG consists of two parts: The ULTRALIFT round sling as a perfect round sling with a high abrasion resistant cover made of dyneema®. (upld). over both legs an ULTRAPROTECT heavy duty protection sleeve is placed. The ULTRAPROTECT (UPHD) protection sleeve is extremely cut- and abrasion resistant.

Application:

This patented ULTRALIFT coil sling is especially developed for lifting coils and loads which are heavy and sharp.



The benefits of this concept are:

- + : in case of severe damages the protection sleeve can be replaced easily, without replacing the ULTRALIFT round sling.
- + : easy handling, due to the size of the ULTRALIFT round sling that fits perfectly into the hook
- + : The total weight of the ULTRALIFT coil sling NG is extremely low.
- + : The lifetime of the ulld will be very long, because of the dyneema based cover.
- + : discharge indicator on the ULTRAPROTECT protection sleeve. (red marker yarns).



		Type	ULCS0010	ULCS0015	ULCS0020	ULCS0025	ULCS0030
		Sleeve width actual ULLD Roundsling	75 - 85mm	90-100 mm	90-100 mm	115-125 mm	115-125 mm
		Sleeve width extra UPHD protection sleeve actual Roundsling	115-125mm	145-155mm	145-155mm	175 -185mm	175-185mm
		WLL	10 t	15 t	20 t	25 t	30 t
			[kg]	[kg]	[kg]	[kg]	[kg]
L in mtr	Length UPHD protection sleeve						
2,5	1,9	ULCS	4,9	6,2	6,4	8,6	9,2
3	2,4	ULCS	5,9	7,4	7,7	10,3	11
3,5	2,9	ULCS	6,9	8,7	9,1	12	12,9
4	3,4	ULCS	7,9	9,9	10,5	13,7	14,7
4,5	3,9	ULCS	8,8	11,2	11,8	15,5	16,5
5	4,4	ULCS	9,8	12,4	13,2	17,2	18,4
5,5	4,9	ULCS	10,8	13,7	14,6	18,9	20,2
6	5,4	ULCS	11,8	14,9	15,9	20,6	22,1
6,5	5,9	ULCS	12,7	16,1	17,3	22,4	23,9
7	6,4	ULCS	13,7	17,4	18,7	24,1	25,8
7,5	6,9	ULCS	14,7	18,6	20,0	25,8	27,6
8	7,4	ULCS	15,7	19,9	21,4	27,5	29,5
8,5	7,9	ULCS	16,7	21,1	22,7	29,3	31,3
9	8,4	ULCS	17,6	22,4	24,1	31	33,1
9,5	8,9	ULCS	18,6	23,6	25,5	32,7	35
10	9,4	ULCS	19,6	24,8	26,8	34,4	36,8

TLX Informationen

TECHLON® ROUND SLING (TLX)

Material:

The construction of a sling is divided into the core and a protection sleeve.
The core is made out of polyester (PES) fibres. The protection sleeve is made out of Techlon (PES).
Due to the special rip and weave structure, Techlon is significantly more resistance to abrasion than standard polyester sleeve.

Physical properties

Specific Gravity (g/cm3)	:	1,38
Elongation at WLL (in %)	:	3 - 4
Usable at temperature	:	-40°C - +100°C
Moisture regain %	:	< 0,5
Resistance to mineral Acid*	:	Good
Resistance to Alkalis*	:	Poor

* Always consult the producer.

Application:

Techlon (TLX) round slings are for general use for lifting loads from WLL 1 ton up to 150 ton. (straight lift).

For the standard assortment we refer to the enclosed product sheets.

Standards:

- Techlon round slings comply with the Machinery Directive 2006/42/EG
- Techlon round slings have a CE-mark, according the Machinery Directive requirements. (Europe).
- Techlon round slings comply with NEN-EN 1492-2 (europe), BS 6668 part 2-1987 safety factor 6:1 (middle east, asia), AS 4497.1-1997 (Australia), OSHA /AS ME B30.9 (USA)

TLX round slings

TECHLON® (TLX)



WEIGHT OF A TLX ROUND SLING WITH TECHLON SLEEVE IN KG

	Type	TLX0100	TLX0150	TLX0200	TLX0250	TLX0300	TLX0350	TLX0400	TLX0450	TLX0500	TLX0550
	WLL	12 t	15 t	20 t	25 t	30 t	35 t	40 t	45 t	50 t	55 t
	Sleeve width	110 mm	110 mm	132 mm	132 mm	160 mm	160 mm	160 mm	180 mm	180 mm	180 mm
	Core diameter	39 mm	46 mm	52 mm	60 mm	65 mm	67 mm	73 mm	78 mm	86 mm	90 mm
EWL in mtr		kg	kg	kg	kg	kg	kg	kg	kg	kg	kg
1	TLX	2,6	3,4	4,4	5,6	6,2	7,3	n/a	n/a	n/a	n/a
2	TLX	5,1	6,6	8,5	11,0	12,3	14,5	16,0	18,9	22,7	25,2
3	TLX	7,5	9,8	12,7	16,5	18,5	21,6	23,9	28,1	33,9	37,6
4	TLX	9,9	13,0	16,8	21,9	24,6	28,7	31,8	37,4	45,0	50,0
5	TLX	12,4	16,2	21,0	27,3	30,7	35,8	39,7	46,7	56,2	62,5
6	TLX	14,8	19,5	25,2	32,7	36,9	42,9	47,6	55,9	67,4	74,9
7	TLX	17,3	22,7	29,3	38,2	43,0	50,0	55,5	65,2	78,6	87,3
8	TLX	19,7	25,9	33,5	43,6	49,1	57,1	63,3	74,4	89,7	99,7
9	TLX	22,2	29,1	37,6	49,0	55,3	64,2	71,2	83,7	100,9	112,1
10	TLX	24,6	32,3	41,8	54,4	61,4	71,3	79,1	93,0	112,1	124,6
11	TLX	27,0	35,5	45,9	59,9	67,6	78,4	87,0	102,2	123,3	137,0
12	TLX	29,5	38,7	50,1	65,3	73,7	85,5	94,9	111,5	134,5	149,4
13	TLX	31,9	41,9	54,3	70,7	79,8	92,6	102,8	120,7	145,6	161,8
14	TLX	34,4	45,2	58,4	76,1	86,0	99,7	110,7	130,0	156,8	174,2
15	TLX	36,8	48,4	62,6	81,5	92,1	106,8	118,5	139,3	168,0	186,6
16	TLX	39,2	51,6	66,7	87,0	98,3	113,9	126,4	148,5	179,2	199,1
17	TLX	41,7	54,8	70,9	92,4	104,4	121,0	134,3	157,8	190,3	211,5
18	TLX	44,1	58,0	75,1	97,8	110,5	128,2	142,2	167,1	201,5	223,9
19	TLX	46,6	61,2	79,2	103,2	116,7	135,3	150,1	176,3	212,7	236,3
20	TLX	49,0	64,4	83,4	108,7	122,8	142,4	158,0	185,6	223,9	248,7
	Extra per mtr. working length	2,5	3,2	4,2	5,4	6,1	7,1	7,9	9,3	11,2	12,4

TLX round slings

WEIGHT OF A TLX ROUND SLING WITH TECHLON SLEEVE IN KG

	Type	TLX0600	TLX0650	TLX0700	TLX0750	TLX0800	TLX0850	TLX0900	TLX0950	TLX1000	TLX 1150
	WLL	60 t	65 t	70 t	75 t	80 t	85 t	90 t	95 t	100 t	115 t
	Sleeve width	220 mm	220 mm	220 mm	320 mm	320 mm	320 mm	320 mm	320 mm	320 mm	320 mm
	Core diameter	95 mm	98 mm	101 mm	105 mm	108 mm	112 mm	116 mm	120 mm	123 mm	140 mm
EWL in mtr		kg	kg	kg	kg	kg	kg	kg	kg	kg	kg
1	TLX	n/a	n/a	n/a	n/a	n/a	n/a	n/a	n/a	n/a	n/a
2	TLX	27,4	29,6	31,3	n/a	n/a	n/a	n/a	n/a	n/a	n/a
3	TLX	40,9	44,2	46,8	51,6	54,1	57,9	60,4	64,2	66,7	84,6
4	TLX	54,4	58,8	62,2	68,6	72,0	77,0	80,4	85,4	88,7	122,6
5	TLX	67,9	73,4	77,7	85,6	89,8	96,1	100,3	106,6	110,8	140,7
6	TLX	81,4	88,1	93,1	102,7	107,7	115,3	120,3	127,9	132,8	168,7
7	TLX	94,9	102,7	108,6	119,7	125,5	134,4	140,2	149,1	154,9	196,7
8	TLX	108,4	117,3	124,0	136,7	143,4	153,5	160,2	170,3	176,9	224,8
9	TLX	121,9	131,9	139,5	153,7	161,2	172,6	180,1	191,5	199,0	252,8
10	TLX	135,4	146,5	154,9	170,7	179,1	191,7	200,1	212,7	221,0	280,8
11	TLX	148,9	161,1	170,4	187,7	196,9	210,8	220,0	233,9	243,0	309,0
12	TLX	162,4	175,7	185,9	204,8	214,8	230,0	240,0	255,2	265,1	337,0
13	TLX	175,9	190,3	201,3	221,8	232,7	249,1	260,0	276,4	287,1	365,0
14	TLX	189,4	204,9	216,8	238,8	250,5	268,2	279,9	297,6	309,2	393,0
15	TLX	202,9	219,5	232,2	255,8	268,4	287,3	299,9	318,8	331,2	421,0
16	TLX	216,4	234,1	247,7	272,8	286,2	306,4	319,8	340,0	353,3	449,0
17	TLX	229,9	248,7	263,1	289,9	304,1	325,6	339,8	361,3	375,3	477,0
18	TLX	243,4	263,4	278,6	306,9	321,9	344,7	359,7	382,5	397,4	505,0
19	TLX	256,9	278,0	294,0	323,9	339,8	363,8	378,9	403,7	419,4	535,0
20	TLX	270,4	292,6	309,5	340,9	357,6	382,9	399,6	424,9	441,4	565,0
	Extra per mtr. working length	13,5	14,6	15,5	17,0	17,9	19,1	20,0	21,2	22,0	30,0

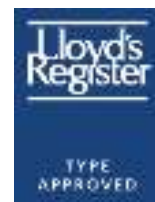

TDQ Information

TDQ WEB SLINGS

Material:

TDQ web slings are built up out of 4-layers polyester (PES) and are available as three versions:

TDQ web slings are made out 100% polyester. The TDQDD and TDQDDS are manufactured with steel triangles (grade 80).

Properties:

Fysical properties

Specific Gravity (g/cm ³)	:	1,38
Elongation at WLL (in %)	:	3 - 4
Usable at temperature	:	-40°C - +100°C
Moisture regain %	:	< 0,5
Resistance to mineral Acid*	:	Good
Resistance to Alkalis*	:	Poor

* Always consult the producer.

Application:

TDQ web slings are for general use for lifting loads from WLL 2 ton up to 40 ton. (straight lift). The width of the webbing sling contributes to a stable and safe lift.

For special applications where the standard assortment does not fit, Technotex Industrial Supply can offer custom made solutions.

For the standard assortment we refer to the enclosed product sheets.

Standards:

- TDQ web slings comply with the Machinery Directive 2006/42/EG
- TDQ web slings have a CE-mark, according to the Machinery Directive requirements. (Europe).
- Techlon web slings comply with NEN-EN 1492-2 (europe), BS 3481/part2-1983 safety factor 6:1 (Middle East, asia), as 4497.1-1997 (Australia), OSHA/ASME B30.9 (USA)

TDQ 4-layer web slings



TDQ



TDQ: 4- LAYER WEB SLINGS

Weight of a 4-layer TDQ web sling.

	Type	TDQ150	TDQ180/200	TDQ240	TDQ300	TDQ300	TDQ500	TDQ600
	WLL	10 t	12 t	15 t	20 t	25 t	30 t	40 t
	Eye width	80 mm	95/105	125 mm	160 mm	160 mm	260 mm	310 mm
	Eye length	650 mm	700 mm	850 mm	1100 mm	1200 mm	1500 mm	1500 mm
	Webbing width	150 mm	180/200	240 mm	300 mm	300 mm	500 mm	600 mm
EWL in mtr		kg	kg	kg	kg	kg	kg	kg
4	TDQ	7,7	10,1	12,4	16,3	19,6	26,5	41,0
5	TDQ	9,6	12,5	15,4	20,3	24,3	32,9	50,8
6	TDQ	11,4	14,9	18,3	24,2	29,0	39,2	60,6
7	TDQ	13,3	17,3	21,3	28,1	33,7	45,6	70,4
8	TDQ	15,1	19,7	24,3	32,0	38,4	52,0	80,2
9	TDQ	17,0	22,1	27,2	35,9	43,1	58,4	90,1
10	TDQ	18,8	24,5	30,2	39,8	47,8	64,7	99,9
11	TDQ	20,7	26,9	33,2	43,7	52,5	71,1	109,7
12	TDQ	22,5	29,3	36,1	47,6	57,2	77,5	119,5
13	TDQ	24,4	31,7	39,1	51,5	61,9	83,8	129,3
14	TDQ	26,2	34,1	42,1	55,4	66,6	90,2	139,2
15	TDQ	28,1	36,5	45,1	59,4	71,3	96,6	149,0
16	TDQ	29,9	38,9	48,0	63,3	76,0	102,9	158,8
17	TDQ	31,8	41,3	51,0	67,2	80,7	109,3	168,6
18	TDQ	33,6	43,7	54,0	71,1	85,4	115,7	178,4
19	TDQ	35,5	46,1	56,9	75,0	90,1	122,1	188,3
20	TDQ	37,3	48,5	59,9	78,9	94,8	128,4	198,1
	Extra per mtr. working length*	1,9	2,4	3,0	3,9	4,7	6,4	9,8

* length above 24 meter please consult the manufacturer.

TDQDD 4-layer triangle web slings

TDQDD



TDQDD 4-LAYER WEB SLING WITH TRIANGLES (MALE)

Weight of a 4-layer TDQDD web sling with triangles (Male)

	Type	TDQDD150	TDQDD180/200	TDQDD180/200	TDQDD240	TDQDD300	TDQDD300
	WLL	10 t	12 t	12 t	15 t	20 t	25 t
	Webbing width	150 mm	180/200	180/200	240 mm	300 mm	300 mm
	Weight Triangle	12,6	15,6	15	28,8	47,8	47,8
EWL in mtr		kg	kg	kg	kg	kg	kg
4	TDQDD	20,3	25,7	10,1	41,2	64,1	67,4
5	TDQDD	22,2	28,1	12,5	44,2	68,1	72,1
6	TDQDD	24,0	30,5	14,9	47,1	72,0	76,8
7	TDQDD	25,9	32,9	17,3	50,1	75,9	81,5
8	TDQDD	27,7	35,3	19,7	53,1	79,8	86,2
9	TDQDD	29,6	37,7	22,1	56,0	83,7	90,9
10	TDQDD	31,4	40,1	24,5	59,0	87,6	95,6
11	TDQDD	33,3	42,5	26,9	62,0	91,5	100,3
12	TDQDD	35,1	44,9	29,3	64,9	95,4	105,0
13	TDQDD	37,0	47,3	31,7	67,9	99,3	109,7
14	TDQDD	38,8	49,7	34,1	70,9	103,2	114,4
15	TDQDD	40,7	52,1	36,5	73,9	107,2	119,1
16	TDQDD	42,5	54,5	38,9	76,8	111,1	123,8
17	TDQDD	44,4	56,9	41,3	79,8	115,0	128,5
18	TDQDD	46,2	59,3	43,7	82,8	118,9	133,2
19	TDQDD	48,1	61,7	46,1	85,7	122,8	137,9
20	TDQDD	49,9	64,1	48,5	88,7	126,7	142,6
	Extra per mtr. working length*	1,8	2,4	2,4	2,9	3,9	4,7

* length above 24 meter please consult the manufacturer.

TDQDD Triangle specifications



TDQDD

TDQDD TRIANGLE SPECIFICATIONS

Triangle Type 2 - male

Type	W.L.L.	S in mm	Q in mm	D in mm	H in mm	E in mm	weight in kg
DTR/10	10	180	35	100	200	320	6,3
DTR/12	12	170	40	90	200	290	7,8
DTR/15	15	300	45	150	250	440	14,4
DTR/20	20	300	50	180	300	460	19
DTR/25	25	300	55	180	300	492	23,9
DTR/30	30	300	55	180	300	492	23,9

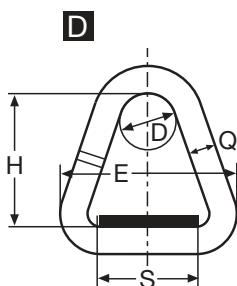

TDQDDS 4-layer triangle web slings

TDQDDS



TDQDDS 4-LAYER WEB SLING WITH TRIANGLES (MALE/FEMALE)

Weighth of a 4-layer TDQDDS web sling with triangles (Male/Female)

		Type	TDQDDS150	TDQDDS180/200	TDQDD180/200	TDQDDS240	TDQDDS300	TDQDDS300
		WLL	10 t	12 t	12 t	15 t	20 t	25 t
		Webbing width	150 mm	180/200	180/200	240 mm	300 mm	300 mm
		Weight Triangle	19,3	23,3	30	41,6	71,4	71,4
EWL in mtr			kg	kg	kg	kg	kg	kg
4	TDQDDS		27,0	33,4	10,1	54,0	87,7	91,0
5	TDQDDS		28,9	35,8	12,5	57,0	91,7	95,7
6	TDQDDS		30,7	38,2	14,9	59,9	95,6	100,4
7	TDQDDS		32,6	40,6	17,3	62,9	99,5	105,1
8	TDQDDS		34,4	43,0	19,7	65,9	103,4	109,8
9	TDQDDS		36,3	45,4	22,1	68,8	107,3	114,5
10	TDQDDS		38,1	47,8	24,5	71,8	111,2	119,2
11	TDQDDS		40,0	50,2	26,9	74,8	115,1	123,9
12	TDQDDS		41,8	52,6	29,3	77,7	119,0	128,6
13	TDQDDS		43,7	55,0	31,7	80,7	122,9	133,3
14	TDQDDS		45,5	57,4	34,1	83,7	126,8	138,0
15	TDQDDS		47,4	59,8	36,5	86,7	130,8	142,7
16	TDQDDS		49,2	62,2	38,9	89,6	134,7	147,4
17	TDQDDS		51,1	64,6	41,3	92,6	138,6	152,1
18	TDQDDS		52,9	67,0	43,7	95,6	142,5	156,8
19	TDQDDS		54,8	69,4	46,1	98,5	146,4	161,5
20	TDQDDS		56,6	71,8	48,5	101,5	150,3	166,2
		Extra per mtr. working length*	1,8	2,4	2,4	2,9	3,9	4,7

* length above 24 meter please consult the manufacturer.

TDQDDS Triangle specifications



TDQDDS TRIANGLE SPECIFICATIONS

Triangle type 2 - male

Type	W.L.L.	S in mm	Q in mm	D in mm	H in mm	E in mm	Weight kg
DTR/10	10	180	35	100	200	320	6,3
DTR/12	12	170	40	90	200	290	7,8
DTR/15	15	300	45	150	250	440	14,4
DTR/20	20	300	50	180	300	460	19
DTR/25	25	300	55	180	300	492	23,9
DTR/30	30	300	55	180	300	492	23,9

Triangle type 2 - female

Type	W.L.L.	S in mm	Q in mm	D in mm	H in mm	P in mm	Weight kg
DSTR/10	10	180	35	100	340	100	13
DSTR/12	12	180	40	100	340	100	15,5
DSTR/15	15	250	45	150	466	120	27,2
DSTR/20	20	300	50	180	540	150	36
DSTR/25	25	300	55	180	540	150	47,5
DSTR/30	30	300	55	180	540	150	47,5

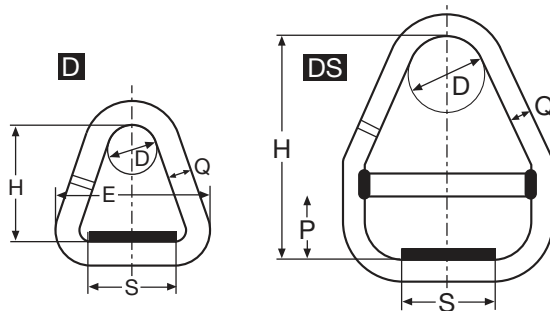

Lashing information



The correct selection and use of lashings is an important issue.

Unitex is one of the world's leading brand manufacturers fulfilling this important issue.

Fundamentals:

To the load securing of cargo transport vehicles are a row of EN 12195ff to be applied. Additional applicable in Germany are the VDI guideline 2700ff and accident prevention rules like "Stand der Technik".

The aim of load securing is: to protect the life and health of humans and animals, just as to protect the load for damaging.

The threats for the involved are mentioned in the various appendix of the EN 12195ff, so that an intended use can be guaranteed.

In Part 2 of EN 12195-2 lashing made of fibers (edition December 2000) in Appendix A, the following Hazards listed (summary):

- The load must not slip, roll over or tip over by loading, transporting and unloading due to improper load securing
- The direct and indirect danger for man and animal must be ruled out.
- Even the secured transportation needs to be guaranteed by the various modes of transport and among the various accelerations.

Vehicles must, taking into account the load distribution and load capacity of the loading area, connection rings, side walls, end walls, etc., absorb the resulting forces (EN 12195-1 under 4 Acceleration).

If the transport vehicle is not in a position to take the required forces, then lashing systems according to EN 12195-2 and 3, and tools for example anti-slip mats (UTX-ARM) are required. The variety of tools today is very large.

Unitex offers his customers not only a large and comprehensive program, but the customers can also qualify through training.

Lashing information

Basic information to load securing:

During the transportation process forces put pressure on the load, as well as on the individual load securing. The mass and friction forces needs to be taken into account.

What everyone needs to know:

We make the set with an example:

We are loading a box of 10 t.

Centre of gravity is in the middle and the load is not in risk of tilting

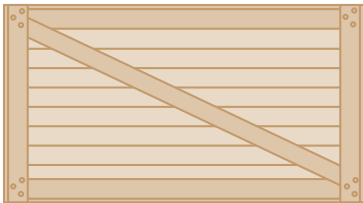

For a concept for load securing certain procedures has to be followed. Unitex would like to introduce an example of 4 stages:

1. stage:

- a) Drivers log in into dispatch department and receive a shipper-briefings
- b) Personal put on personal protective equipment
- c) Make sure the floor of the load area is clean
- d) Make sure intact lashing (web lashing, chain lashing, etc.) and additional tools (anti-slip mats, connecting rings etc.) is ready
- e) Prepare the vehicle body for loading

2. stage:

- a) Talk over the way of loading with the truck driver
- b) Positioning (load dividing)of the load to be discussed with the driver
- c) Under layers of wood to be placed, so that the vehicle will not be damaged by overload.
- d) The way of lashing (closing form, closing force or in a combination) to be discuss with the driver

3. stage:

- a) Safe putting on of the load with a crane or
- b) Taking the load safely in forklift operation
- c) achieve closing form to the front f.e. through vehicle set up, connection rings, under layers of wood or head sling
- d) load may be dropped to anti slip mat

Lashing information

4. stage:

- a) prepare lashings (web lashing, chain lashing, etc.) and additional tools for selected way of lashing and calculation for load securing
- b) decline the load securing by the shipper
- c) the driver is made aware of the fact that the load securing can be inspected along the road
- d) The vehicle structure will be closed if needed

TIP: Unitex offers you the service to introduce load securing in your company.

In the 4 phases following actions are mentioned:

We load the 10t box under the load dividing on the truck.

1. Question we ask ourselves:

Which method of load securing can be used?

We make a split between form fitting and force fitting load securing.

closing form load securing:

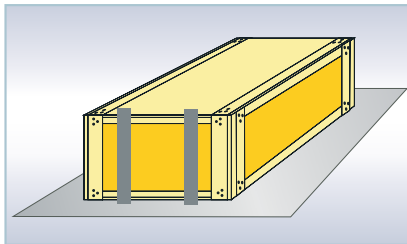

Buttress of the load against connecting rings, front wall, side walls etc. The securing can be made through a direct connection of the load or indirect connection of the load due to direct lashing f.e. diagonal lashing, hypotenuse lashing, circumference lashing and head lashing.

A closing force load securing is always pre-pulling.

closing force load securing:

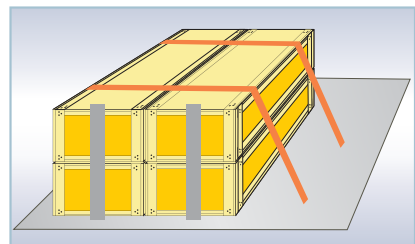
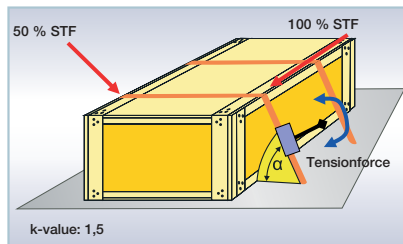
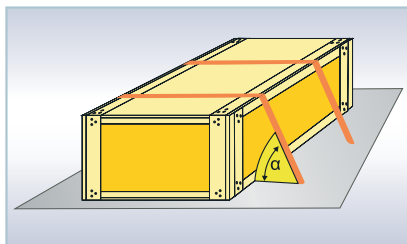

Over the top lashing is a force fitting load securing. By increasing the contact pressure it prevents the load from shifting. By under laying the anti slip mats the number of lashings can be reduced.

The number of lashing is depending on the mass (m), friction (μ D), lashing angle α (alpha) and the standard tension force (STF) of the lashings.

closing form and closing force load securing can be used in combination.

Lashing information

Important hold of the lashing:

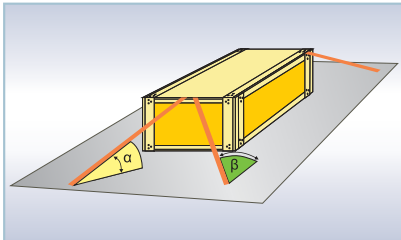

LC:

- LC = Lashing Capacity - to lash
- Lashing Capacity (LC) Lashing force diagonal lashing in straight line. f.e. LC 2000 daN

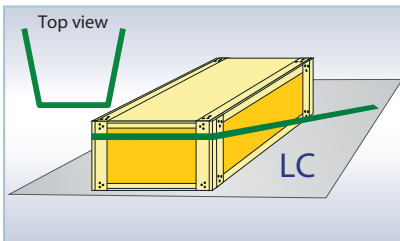

LC:

- in circumference f.e. LC 4000 daN
- Use by a head- and side sling

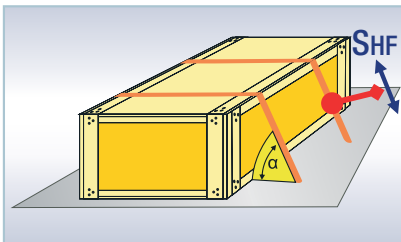

S_{HF} :

- Standard Hand Force = Regular manual force (50 daN)
- Tension will be put on the lashing system with this force

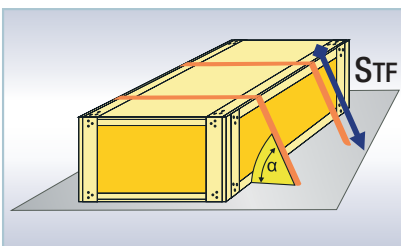

S_{TF} :

- Standard Tension Force – pre tension force of the lashing system f.e. from 250 daN up to 550 daN for polyester lashing systems
- With lashing chain systems from appr.1000 daN up to 2500 daN

TIP: Practical Advice on the use of lashings systems according to EN 12195-2:

In the selection and in the use of lashing systems it is necessary to take in mind the lashing forces, as well as way of use and the way it is working on the load.

Lashing information

2. Question:

How big are the expected forces?

According to EN 12195-1 the following forces contribute to road vehicles. These are calculated with support of the acceleration coefficient.

c = acceleration coefficient

- 0.8 in forward road direction (x)
- 0.5 opposite of the forward road direction (rear direction) (x)
- 0.5 side ways of the forward road direction by a stable load(y)
- 0.7 for non-tilt secured cargo (side)
- 1.0 cz (vertical)

We count with a wooden box:

10t (centre of gravity in the middle and no danger for tilting)

c = acceleration coefficient

- 0.8 in forward road direction
10t x 0.8 = 8t secured forces forwards
- 0.5 opposite of the forward road direction (x)
10t x 0.5 = 5t secured forces in rear direction
- 0.5 in side way direction (y)
10t x 0.5 = 5t secured forces side ways to the direction
- 1.0 cz (vertical)
10t x 1.0 = 10t vertical forces (load vehicle floor)

From the practice spoken in metric tons, we need to calculate in forward direction with 8 tons of backup power, in rear and side way direction with 5 tons securing forces.

8 tons = 8000 kg x 9.81 m/s² = 78,480 N = 7848 daN securing forward road direction

5 t = 5000 kg x 9.81 m/s² = 49,05 N = 4905 daN securing force in rear and side way direction

3. Question:

What must be observed with closing force load securing?

1. Example:

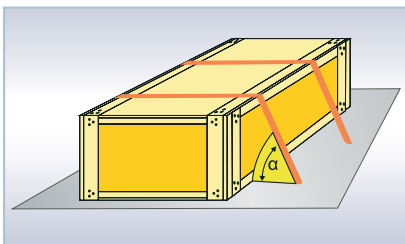

friction between the load and the transport vehicle with wooden floors $\mu_D = 0.3$.

Lashing angle $\alpha: 80^\circ$, Stf: 550 daN

Calculating the number of lashings with over the top lashing (EN 12195-1, formula 5):

$$n \geq \frac{(C_{xy} - \mu_D * C_z) * m * g}{k * \mu_D * \sin(\alpha) * F_T}$$

Results: We obtained a minimum number of lashings = 23 pieces of lashing systems with Ergo ratchet - STF 550 daN Type 50A / 2

Lashing information

2. Example:

Anti slip mats between the load and transport vehicle with $\mu_D = 0.6$.

Lashing angle $\alpha: 80^\circ$, Stf: 550daN

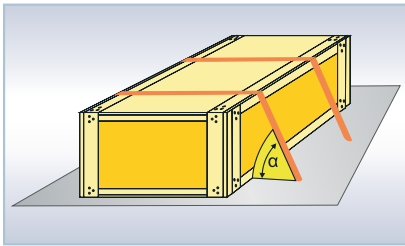

Calculating the number of lashings by over the top lashing (EN 12195-1, formula 5):

$$n \geq \frac{(C_{x,y} - \mu_D * C_Z) * m * g}{k * \mu_D * \sin(\alpha) * F_T}$$

Results:

We obtained a minimum number of lashings = 5 pieces of lashing systems with Ergo ratchet - STF 550daN Type 50A / 2 and anti slip mats.

TIP: Due to the use of anti slip mats from Technotex you will get an secured and practical load securing.

3. closing form by two connection rings with a total blocking force of 2000 daN

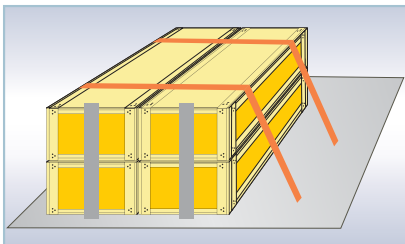

Example:

Anti slip mats between the load and transport vehicle with $\mu_D = 0.6$.

Lashing angle $\alpha: 80^\circ$, Stf: 550 daN

Calculating the number of lashings by over the top lashing (EN 12195-1, formula 5):

$$n \geq \frac{(C_{x,y} - \mu_D * C_Z) * m * g}{k * \mu_D * \sin(\alpha) * F_T}$$

Results:

With the blocking force forwards with 2000 daN, we obtain a minimum number of lashing systems= 2 pieces of lashing systems with Ergo ratchet

- STF 550 daN Type 50A/2.und 2 pieces anti slip mats

Caution: The principle: By over the top lashing always use at least 2 lashing systems

Result of the load securing:



Example 2 and 3 can be implemented well in practice with products from Technotex. Still some important indications has to be respected!



As a special service Technotex offers a CD-Rom. This specially developed calculation program is a important tool for identifying the necessary number of lashing systems.



25mm lashing systems

25MM LASHINGS WITH RATCHETS

	Type	1 or 2 part	Lashing capacity	Standard Tension Force (S_{TF}) by S_{HF} 50 daN	Nr. of the end-fitting
	25B/1	1- part	800 daN	S_{TF} 240 daN	
	25B/2	2- parts	400 daN	S_{TF} 120 daN	2, 3, 4, 5, 8, 10

	Type	1 or 2 part	Lashing capacity	Standard Tension Force (S_{TF}) by S_{HF} 50 daN	Nr. of the end-fitting
	25A/1	1- part	1500 daN	S_{TF} 270 daN	
	25A/2	2-part	750 daN	S_{TF} 135 daN	3, 4, 5, 10



Tüv approval for lashings with hook No. 2 and 3



 Art.nr 23.208	 Art.nr 23.207	 Art.nr 23.301	 Art.nr 23.525	 Art.nr 23.219	 *Maximum Lc Capacity 340 daN Art.nr 23.229	 Art.nr 23.204
--	--	--	--	--	--	--

25mm lashing systems

25MM LASHINGS WITH CAMBUCKLE

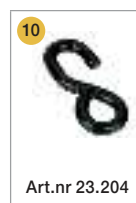
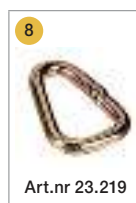
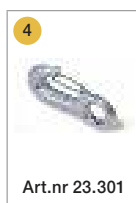
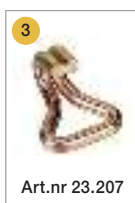
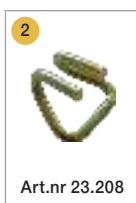

	Type	1 or 2 part	Lashing capacity	Standard Tension Force (S_{TF}) by S_{HF} 50 daN	Nr. of the endfitting
	IG25/1	1-part	250 daN		
	IG25/2	2-parts	125 daN		2, 3, 4, 5, 8, 10





35mm lashing systems

35MM LASHING WITH RATCHETS



	Type	1 or 2 part	Lashing capacity	Standard Tension Force (S_{TF}) by S_{HF} 50 daN	Nr. of the endfitting
	35B/1	1-part	2000 daN	S_{TF} 360 daN	
	35B/2	2-parts	1000 daN	S_{TF} 180 daN	1, 2, 3, 4, 5*, 10*

	Type	1 or 2 part	Lashing capacity	Standard Tension Force (S_{TF}) by S_{HF} 50 daN	Nr. of the endfitting
	35A/1	1-part	3000 daN	S_{TF} 360 daN	
	35A/2	2-parts	1500 daN	S_{TF} 180 daN	1, 2, 3, 4, 5*



Tüv approval for lashings with hook No. 2 and 3



 Art.nr 23.305	 Art.nr 23.303	 Art.nr 23.202	 Art.nr 23.301	 *Maximum Lc Capacity 750 daN Art.nr 23.525	 *Maximum Lc Capacity 750 daN Art.nr 23.204
--	--	--	--	---	--

35mm lashing systems



35MM LASHINGS WITH CAMBUCKLE

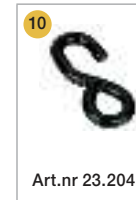
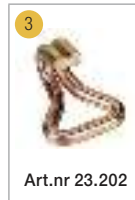

	Type	1 or 2 part	Lashing capacity	Standard Tension Force (S_{TF}) by S_{HF} 50 daN	Nr. of the end-fitting
	IG35/1	1-part	500 daN		
	IG35/2	2-parts	250 daN		1, 2, 3, 4, 5, 10











50mm lashing systems

50MM LASHINGS WITH RATCHETS

	Type	1 or 2 part	Lashing capacity	Standard Tension Force (S_{TF}) by S_{HF} 50 daN	Nr. of the end-fitting
	50L/1	1-part	2000 daN	S_{TF} 360 daN	
	50L/2	2-parts	1000 daN	S_{TF} 180 daN	1, 2, 3, 5*, 6, 7, 8, 9

	Type	1 or 2 part	Lashing capacity	Standard Tension Force (S_{TF}) by S_{HF} 50 daN	Nr. of the end-fitting
	50C/1	1-part	3000 daN	S_{TF} 420 daN	
	50C/2	2-parts	1500 daN	S_{TF} 210 daN	1, 2, 3, 5*, 6, 7, 8, 9



 Art.nr 23.502	 Art.nr 23.506	 Art.nr 23.532	 *Maximum Lc Capacity 750 daN Art.nr 23.525	 Art.nr 23.526	 Art.nr 23.531
 Art.nr 23.527	 Art.nr 23.528				

Tüv approval for lashings with hook No. 2 and 3

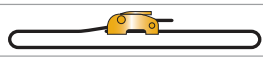

50mm lashing systems

50MM LASHINGS 1-PART WITH CAMBUCKLE

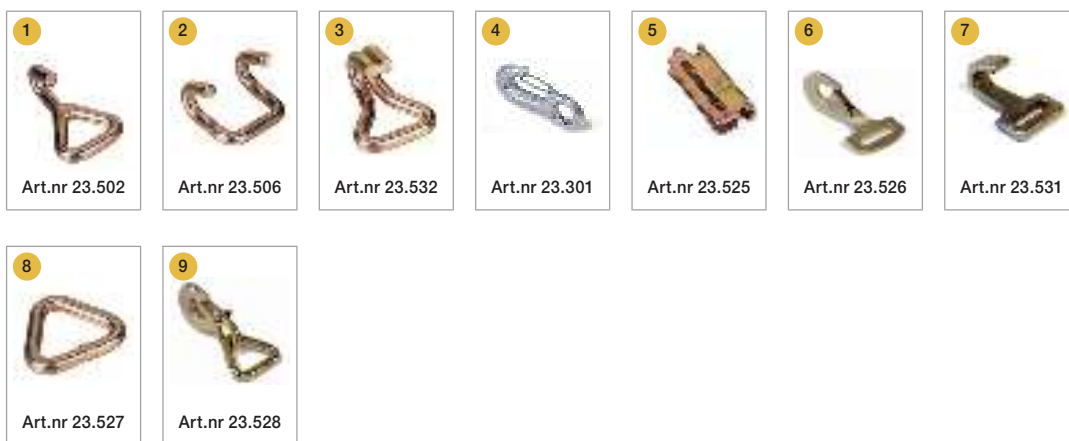

	Type	1 or 2 part	Lashing capacity	Standard Tension Force (S_{TF}) by S_{HF} 50 daN	Nr. of the end-fitting
	IG50/1	1-part	1200 daN		
	IG50/2	2-parts	600 daN		1, 2, 3, 4, 5, 6, 7, 8, 9



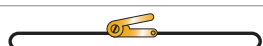

50mm lashing 2000/4000 daN systems

50MM LASHINGS WITH RATCHETS









	Type	1 or 2 part	Lashing capacity	Standard Tension Force (S_{TF}) by S_{HF} 50 daN	Nr. of the end-fitting
	50BS/1	1-part	4000 daN	S_{TF} 400 daN	
	50BS/2	2-parts	2000 daN	S_{TF} 200 daN	1, 2, 3, 6, 7, 8, 9

	Type	1 or 2 part	Lashing capacity	Standard Tension Force (S_{TF}) by S_{HF} 50 daN	Nr. of the end-fitting
	50B/1	1-part	4000 daN	S_{TF} 640 daN	
	50B/2	2-parts	2000 daN	S_{TF} 320 daN	1, 2, 3, 6, 7, 8, 9

Tüv approval for lashings with hook No. 2 and 3





 Art.nr 23.502	 Art.nr 23.506	 Art.nr 23.532	 Art.nr 23.526	 Art.nr 23.531	 Art.nr 23.527	 Art.nr 23.528
--	--	--	--	--	---	--



50mm lashing 2000/4000 daN systems

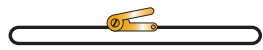

50MM LASHINGS WITH LONG-HANDLE ERGO RATCHETS

	Type	1 or 2 part	Lashing capacity	Standard Tension Force (S_{TF}) by S_{HF} 50 daN	Nr. of the end-fitting
	50BE/1	1-part	4000 daN	S_{TF} 960 daN	
	50BE/2	2-parts	2000 daN	S_{TF} 480 daN	1, 2, 3, 6, 7, 8, 9

50MM LASHINGS WITH EASY RELEASE RATCHETS

	Type	1 or 2 part	Lashing capacity	Standard Tension Force (S_{TF}) by S_{HF} 50 daN	Nr. of the end-fitting
	50BER/1	1-part	4000 daN	S_{TF} 800 daN	
	50BER/2	2-parts	2000 daN	S_{TF} 400 daN	1, 2, 3, 6, 7, 8, 9

Tüv approval for lashings with hook No. 2 and 3



50mm lashing 2500/5000 daN systems

50MM LASHINGS WITH RATCHETS



	Type	1 or 2 part	Lashing capacity	Standard Tension Force (S_{TF}) by S_{HF} 50 daN	Nr. of the end-fitting
	50AS/1	1-part	5000 daN	S_{TF} 500daN	
	50AS/2	2-parts	2500 daN	S_{TF} 250 daN	1, 2, 3, 6, 7, 8, 9

	Type	1 or 2 part	Lashing capacity	Standard Tension Force (S_{TF}) by S_{HF} 50 daN	Nr. of the end-fitting
	50A/1	1-part	5000 daN	S_{TF} 700 daN	
	50A/2	2-parts	2500 daN	S_{TF} 350 daN	1, 2, 3, 6, 7, 8, 9



Tüv approval for lashings with hook No. 2 and 3



Art.nr 23.502	Art.nr 23.506	Art.nr 23.532	Art.nr 23.526	Art.nr 23.531	Art.nr 23.527	Art.nr 23.528



50mm lashing 2500/5000 daN systems

50MM LASHINGS WITH LONG-HANDLE ERGO RATCHETS

	Type	1 or 2 part	Lashing capacity	Standard Tension Force (S_{TF}) by S_{HF} 50 daN	Nr. of the end-fitting
	50AE/1	1-part	5000 daN	S_{TF} 1100 daN	
	50AE/2	2-parts	2500 daN	S_{TF} 550 daN	1, 2, 3, 6, 7, 8, 9



50MM LASHINGS WITH EASY RELEASE RATCHETS

	Type	1 or 2 part	Lashing capacity	Standard Tension Force (S_{TF}) by S_{HF} 50 daN	Nr. of the end-fitting
	50AER/1	1-part	5000 daN	S_{TF} 800 daN	
	50AER/2	2-parts	2500 daN	S_{TF} 400 daN	1, 2, 3, 6, 7, 8, 9



Tüv approval for lashings with hook No. 2 and 3





75/100 mm lashing systems

75MM LASHING WITH RATCHET



	Type	1 or 2 part	Lashing capacity	Standard Tension Force (S_{TF}) by S_{HF} 50 daN	Nr. of the end-fitting
	75A/1	1-part	10000 daN	S_{TF} 1000 daN	
	75A/2	2-parts	5000 daN	S_{TF} 500 daN	2, 3, 9

100MM LASHING WITH RATCHET

	Type	1 or 2 part	Lashing capacity	Standard Tension Force (S_{TF}) by S_{HF} 50 daN	Nr. of the end-fitting
	100A/1	1-part	10000 daN	S_{TF} 1000 daN	
	100A/2	2-parts	5000 daN	S_{TF} 500 daN	2, 3, 9

2



Art.nr 23.702

3



Art.nr 23.701























9



Art.nr 23.704

Lashings hooks

LASHING HOOKS (PARTS)

	<p>Art.nr 23.207</p> <p>25mm Double "J" hook for lashing system sb25A and B Maximum LC Capacity 750 daN</p>		<p>Art.nr 23.202</p> <p>35mm Double "J" hook MBL 3000 kgs for lashing system sb35A and B Maximum LC Capacity 1500 daN</p>		<p>Art.nr 23.532</p> <p>50mm Double "J" hook MBL 5000 kgs for lashing system SB50A and SB50A Maximum LC Capacity 2500 daN</p>
	<p>Art.nr 23.540</p> <p>50mm Double "J" hook with keeper MBL 5000 kgs for lashing system sb50A and B Maximum LC Capacity 2500 daN</p>		<p>Art.nr 23.701</p> <p>75mm Double "J" hook MBL 10000 kgs for lashing system SB75A Maximum LC Capacity 5000 daN</p>		<p>Art.nr 23.208</p> <p>25mm U-Hook MBL 1000 kgs for lashing system IG25 and SB25B Maximum LC Capacity 500 daN</p>
	<p>Art.nr 23.303</p> <p>35mm U-hook MBL 3000 kgs for lashing system sb35A and B Maximum LC Capacity 1500 daN</p>		<p>Art.nr 23.506</p> <p>50mm U-hook MBL 5000 kgs for lashing system sb50A and B Maximum LC Capacity 2500 daN</p>		<p>Art.nr 23.702</p> <p>75mm U-Hook MBL 10000 kgs for lashing system SB75A Maximum LC Capacity 5000 daN</p>
	<p>Art.nr 23.305</p> <p>35mm single J-hook MBL 3000 kgs for lashing system sb35A and B Maximum LC Capacity 1500 daN</p>		<p>Art.nr 23.502</p> <p>50mm single J-hook MBL 5000 kgs for lashing system sb35A and B Maximum LC Capacity 2500 daN</p>		<p>Art.nr 23.229</p> <p>25mm S-hook MBL 680 kgs for lashing system SBIG25 Maximum LC Capacity 340 daN</p>
	<p>Art.nr 23.204</p> <p>25mm S-Hook MBL 1500 kgs for lashing systems SBIG35, SBIG50, SB25A and B Maximum LC capacity 750 daN</p>		<p>Art.nr 23.525</p> <p>50mm end track spring fitting MBL 1500 kgs for lashing systems SBIG35, SBIG50 SB25A and B SB35B SB50C Maximum LC Capacity 750 daN</p>		<p>Art.nr 23.526</p> <p>50mm Twisted Snap Hook MBL 5000 kgs for lashing systems SB50A and B Maximum LC capacity 2500 daN</p>
	<p>Art.nr 23.505</p> <p>50mm Flat Snap Hhook MBL 5000 kgs for lashing systems SB50A and B Maximum LC capacity 2500 daN</p>		<p>Art.nr 23.531</p> <p>50mm Forged Flat Hook MBL 5000 kgs for lashing systems SB50A and B Maximum LC capacity 2500 daN</p>		<p>Art.nr 23.528</p> <p>50mm Triangel Forged Hook MBL 5000 kgs for lashing systems SB50A And B Maximum LC capacity 2500 daN</p>
	<p>Art.nr 23.704</p> <p>75mm Triangel Forged Hook MBL 10000 kgs for lashing systems SB75A Maximum LC capacity 5000 daN</p>		<p>Art.nr 23.301</p> <p>Forged Hook with Keeper MBL 2500 kgs for lashing systems SBIG, SB25 SB35B Maximum LC capacity 1250 daN</p>		<p>Art.nr 23.219</p> <p>25mm D-Ring MBL 800 kgs for lashing systems SBIG25 and B25B Maximum LC capacity 400 daN</p>
	<p>Art.nr 23.527</p> <p>50mm D-Ring MBL 5000 kgs for lashing systems SB50A And B Maximum LC capacity 2500 daN</p>		<p>Art.nr 23.558</p> <p>50mm Flat D-Ring MBL 5000 kgs for lashing systems SB50A and B Maximum LC capacity 2500 daN</p>		

Ratchets

RATCHETS

	<p>Art.nr 23.706</p> <p>75mm Ratchet for system sb75 Maximum LC Capacity 5000 daN</p>		<p>Art.nr 23.509</p> <p>50mm Ergo-Ratchet for system sb50A and B Maximum LC Capacity 2500 daN</p>		<p>Art.nr 23.513</p> <p>50mm Easy-Release-Ratchet for system sb50A and B Maximum LC Capacity 2500 daN</p>
	<p>Art.nr 23.503</p> <p>50mm Ratchet for system sb50A and B Maximum LC Capacity 2500 daN</p>		<p>Art.nr 23.507</p> <p>50mm Short- Ratchet for system sb50A and B Maximum LC Capacity 2500 daN</p>		<p>Art.nr 23.504</p> <p>50mm Light Duty Ratchet for system sb50L Maximum LC Capacity 1000 daN</p>
	<p>Art.nr 23.315</p> <p>35mm Ratchet for system sb35A Maximum LC Capacity 1500 daN</p>		<p>Art.nr 23.314</p> <p>35mm Ratchet for system sb35B Maximum LC Capacity 1000 daN</p>		<p>Art.nr 23.202</p> <p>25mm Ratchet for system sb25A Maximum LC Capacity 750 daN</p>
	<p>Art.nr 23.316</p> <p>25mm Stainless steel Ratchet for system sb25A Maximum LC Capacity 750 daN</p>		<p>Art.nr 23.201</p> <p>25mm Ratchet for system sb25B Maximum LC Capacity 400 daN</p>		<p>Art.nr 23.203</p> <p>25mm Black Ratchet for system sb25B Maximum LC Capacity 400 daN</p>
	<p>Art.nr 23.524</p> <p>50mm Cambuckle for system sbig50 Maximum LC Capacity 600 daN</p>		<p>Art.nr 23.300</p> <p>35mm Cambuckle for system sbig35 Maximum LC Capacity 250 daN</p>		<p>Art.nr 23.218</p> <p>25mm Cambuckle for system sbig25 Maximum LC Capacity 125 daN</p>

One Way Lashing

The UNIFIXX One-way lashing systems offers a lashing solution by combining low cost with safe transport.

The UNIFIXX solution is much better than the traditional way of securing loads and over the last decades it has replaced traditional products such as ropes and chains. The UNIFIXX one-way lashing systems are light weight load securing solutions avoiding damage risk on heavy and expensive loads. Our high tenacity products are extremely suitable for securing loads on crates, pallets, in containers, flattracks and on wagons. The UNIFIXX One-way lashing webbing is supplied in combination with buckles and tensioners.

The UNIFIXX One-way lashing systems are approved by the Germanischer Lloyd, one of the toughest approvals. The allowable working loads vary from 500daN to 4.000 daN with a width variation from 30mm to 50mm. The lashings are produced in-house ensuring a high flexibility regarding individuals wishes. UNIFIXX can be manufactured, personalized and packed to your individual specifications.



Type	Width (mm)	MBS Lashing (daN)	Packing (plastic bags)	System Strength (daN)- Buckle
W323	32	2300	250 mtr.	4000 - B3030
W435	40	3500	200 mtr.	6000 - B4040
W450	40	5000	200 mtr.	7500 - B4040
W523	50	2300	300 mtr.	3000 - B5020
W550	50	5000	200 mtr.	9000 - B5050
W560	50	6000	150 mtr.	9500 - B5050
W575	50	7500	150 mtr.	10000 - B5050

Type	Width (mm)	
B3030	30	
B4040	40	
B5050	50	
B3030S	30	
B5020	50	
B4050W	50	
B5050W		
H5050	50	
SB10-7	32 mm	
SB12-7	40 mm	
SB12-8	40 mm	
SBF10-7	32 mm	
SBF12-7	40 mm	
SBF12-8	40 mm	



TENSH26



PTENS01



UR5050

One Way Lashing

USER INSTRUCTIONS UNIFIXX ONE WAY LASHING



1 Thread one end of the lashing webbing through the middle of the buckle



2 Make a loop around one end and insert the lashing webbing under the looped end



3 Lead the end back through the middle of the buckle



4 Pull the lashing webbing away from the buckle



5 Repeat step 1 - 4 with the opposite end



6 Pull tight and allow a min. overlap of 25 cm for tensioner use



7 Squeeze the handle of the tensioner and lead the webbing under the break lever



8 Pull the handle wide open and place the top lashing webbing part through the cutter and tensioner slot



9 Move the handle up and down to tension the lashing webbing; keep min. 8 cm overlap from the buckle



Squeeze the handle to cut the lashing webbing (10), release the break (11) and remove the tensioner (12)

Unitex Anti slip matting

ANTI SLIP MATTING FOR LOAD SECURING



The safe loading of vehicles is vitally in preventing injury to people and damage of property when transporting a load the load must be restrained tidily and safely in order to prevent the load from shifting during transport. The load is required to withstand forces of at least:

- 80% of its weight in forward direction (braking)
- 50% of its weight sideways and backwards (acceleration and cornering).
- 20% of the weight in upwards direction (rough roads)

Load-securing with Polyester or chain lashing is not always sufficient especially when there is low friction between the load and bearing surface at full stop surface. Load restraint equipment is most efficient when there is high friction between the vehicle and the load surface, for this you need appropriate interlayer packing. Unitex has specially designed anti-slip rubber matting for interlayer packing "UTX-ARM" which increases the friction between the two surfaces. In fact this UTX-ARM anti slip matting should belong to the standard equipment for every responsible and professional transporter.

Unitex UTX-ARM Anti slip matting increases the friction between the surface up to at least $0,6\mu$ as a result the load can be restrained with fewer lashings because you need less tension or lashing force to secure the load. Unitex UTX-ARM anti slip matting is also very useful for loads which can't withstand high pressure or tension forces.

Unitex Anti slip matting

ANTI SLIP MATTING SPECIAL FOR CONCRETE PARTS (UTX-ARM-9510RHS)

Unitex anti slip matting on rubber basis is special developed for concrete parts The coloured anti slip matting does not give of and therefore is suitable for the use on concrete

	Type	Colour	measurements	thickness	standard size	Material
	UTD-ARM-9510RHS	Multi-coloured	on rolls or cutted lengthes	from 3 mm up to 20 mm	Rolls 250 x 8 x 5.000 mm	rubber based matts abrasion restistance ($\mu > 0,6$)

FE: For rolls Rollenware 250mm x 8mm x 5.000 mm
UTD-ARM-9510RHS-02500805000

ANTI SLIP MATTING FOR LOAD RESTRAINING (UTX-ARM-7210)

Unitex anti slip matting on a synthetic rubber basis (SBR/SNR) is special designed for professional load restraining Due to the black granulate mix we are able to achieve a sliding resistance of more than $0,7\mu$ The Unitex anti slip matting is tested and certified by a independent test institute BIA (Berufsgenossenschaft im BG-PRÜFZERT institute für Arbeitssicherheit)

	Type	Colour	measurements	thickness	standard size	Material
	UTD-ARM-7210	Black	on rolls or cutted lengthes	from 3 mm up to 20 mm	Rolls 250 x 8 x 5.000 mm	on SBR/NBR-Basis with a extreme high abrasion resistance ($\mu > 0,7$)

FE: For rolls Rollenware 250mm x 8mm x 5.000 mm
UTD-ARM-7210-02500805000

TURTLE MAX Timber Lashing System

Professional securing system for timber deck cargo
(in compliance with IMO 275E
“Code of Safe Practice for Ships Carrying Timber Deck Cargoes”)

Specifications:

Safe working load	: 133 kN	MBL	: 200 kN
Temperature range	: of -40°C to +100°C	Weight	: 10 kg
Webbing	: Polyester < 5% elongation, measured from the pre-tension load of 27 to 106.4 kN		
Width	: 100 mm	Length	: variable
Take up	: + 2 m	Handling	: one man operation
Certificates	: Germanischer Lloyd	End connectors	: hook, shackles or customised
Minimum pre-tension	: 2.700 kg	Maintenance	: very low



The main advantages of Turtle Max timber lashing systems are:

- load restraint using a tensioning device (ratchet)
- effective and safe control of load whilst in transportation
- extremely and efficient tie-down and release of load thus saving time
- no damage to the load being tied down

TURTLE MAX Timber Lashing System

SINGLE AND DOUBLE WINCH ARRANGEMENT.

single winch arrangement



Components of each system

- 1 x Ratchet Winch
- 1 x Web band 100% PES, fixed end / 1 reinforced eye / 1 soft eye
- 1 x Web band 100% PES, loose end / 1 reinforced eye / 1 open end
- 2 x shackles

Lashing arrangement for unitized/package timber

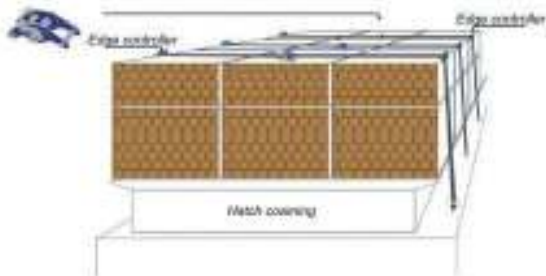

Lashing arrangement for logs

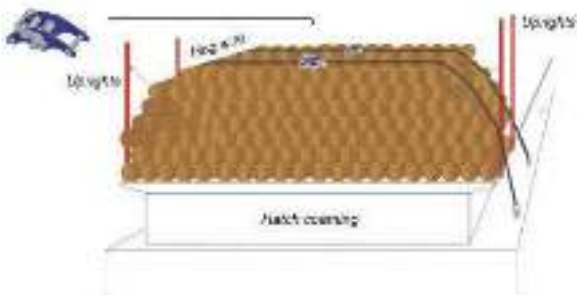

double winch arrangement



Components of each system

- 2 x Ratchet Winch with 1 steel adapter each
- 1 x Web band 100% PES, loose end, variable length
- 2 x Edge controller (web band protector) - Optional

Lashing arrangement for unitized/package timber

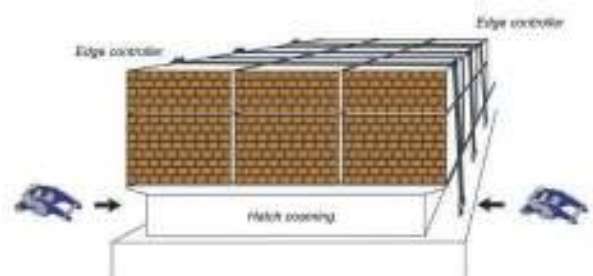

Lashing arrangement for logs

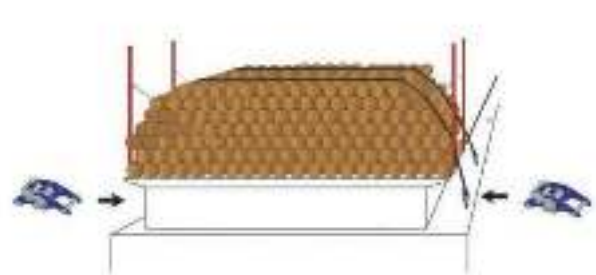

TURTLE MAX Timber Lashing System

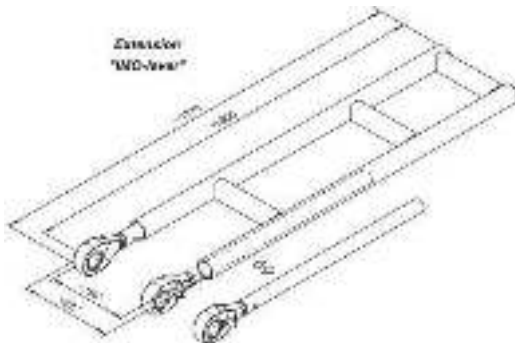

Ratched handle with
32 mm box spanner

Specification

- Light weight design
- IMO-lever hot dip galvanized
- High quality stainless steel ratchet
- One set consists of two ratchets and one extension
- Low budget solution for narrow working space is available on request

SPECIFICATIONS TURTLE MAX TIMBER LASHING SYSTEM, SINGLE WINCH ARRANGEMENT

Specification of Item	M.S.L KN	Test Load KN	M.B.L. KN	PCS
Turtle Max Web system TurtleWinch Nrs: 043401 - 043410 2 x Connector bolt and nut, lock and slip device, tensioner	100	95	200	10
Turtle fixed Side strop L=2.00 m PW 100/240 semi Duplex fl.cyc/flcyc 0,35 m 100% Polyester, t = 5 mm	140	95	220	10
Turtle Variable Side strop L=23.00 m PW 100/240 semi Duplex fl.cyc/flcyc 0,35 m 100% Polyester, t = 5 mm	140	95	220	10
Timber Max Lashing Shackle Red-Pin galvanized Pin 25 mm/ Bow 19 mm	140	95	270	20

AirMaxx Dunnagebags

AirMaxx bags used for transport of forest products and break-bulk, eliminate damage caused by cargo shifting. Once inserted into empty space, the AirMaxx bags are inflated with compressed air. AirMaxx bags adapt themselves to almost any shape, space or void.

Due to the high filling pressure the AirMaxx bags move the cargo to reduce the number of small voids.

The AirMaxx Bag is very easy to handle, even for one person. Only a few minutes per bag is required for installation, thus eliminating the need for carpenters, timber and extra dock time.

AirMaxx is manufactured of a new durable and lightweight synthetic material. The small weight and small size after deflation simplify storage. AirMaxx is re-usable. Proper operation is guaranteed for one year. One year guarantee on seams and valves.



Paper reels , vertical stowage :

Every horizontal layer is lashed on the front and aft by lashing chains secured to the fixed lashing points in the hold's sides. The reels are protected by timber. Dunnage bags are used in the upper layer of reels to fill up gaps and to avoid any movement between the reels.(subtr. CSM papercarrier)

FOUR EASY STEPS TO A TOTALLY PROTECTED CARGO

1. When deflated the dunnage bag is easy to load between sections.
2. Fill bag until load is secured and space completely filled.
3. Load will remain set.
4. Deflate and remove after shipment.

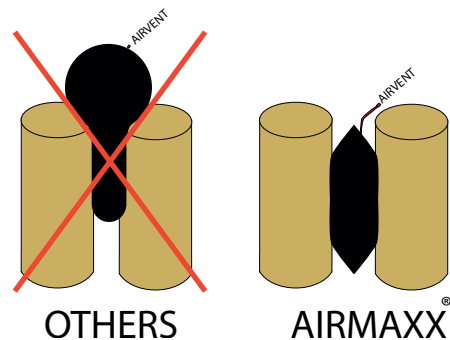

Specifications

Size empty	: 100 x 130 en 100 x 200 cm	Handling	: one man operation
Take up	: 55 cm	Temperature	: -25 °C to + 50 °C
Automatic fillstop	: 60 – 80 Kn/m ²	Maintenance	: very low
Weight	: 4.5 kg	Guarantee	: 2 year on welded seams
Width	: 100 cm		
Length	: 100 – 500 cm		

AirMaxx Dunnagebags



ITEM	QTY.	PART NO.	DESCRIPTION
1	1	01-001	Mafa quickconnector
2	1	01-001	PVC hose / fill
3	1	01-001	Automatic fillstop
4	1	01-001	Release stop
5	1	01-001	Outerbag
6	1	01-001	Innerbag
SCALE		TITLE	
1: 10		Drw no 1.01 AirMaxx Dunnagebag	
REV.	DESCRIPTION	DATE	BY
A	for internal approval	13-10-2004	
FILENAME		DRAWN BY	
AIRBAG 2003 DRW 1.VSD		J.D. Kaptein	

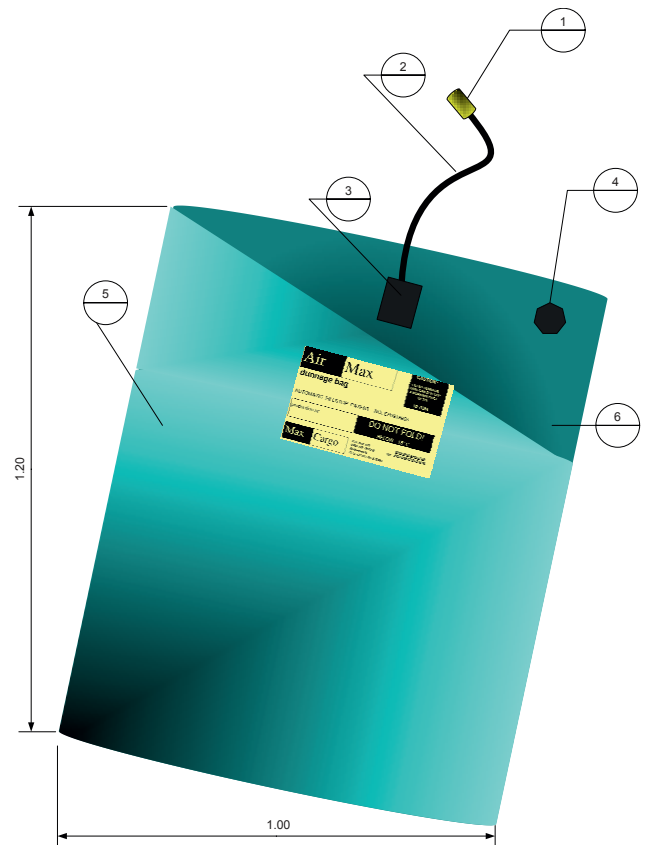

Contents protection materials

UP Protection sleeves	Page	58 - 59
UPSP Corner protection	Page	60
UPCP Corner protection	Page	61
PU Technical information	Page	62 - 63
Purtecta Color	Page	64
PU-Sleeve	Page	65 - 66
PU Coating	Page	67
PU Cornerprotection	Page	68 - 69
PU Chain protection	Page	70
Protection Sleeve	Page	71

UP Protection sleeves

ULTRAPROTECT



ULTRAPROTECT PROTECTION SLEEVES FOR UNITEX WEB SLINGS

“heavy duty uphd” and “light duty upld”

Webbing width in mm	webbing layers	ultraprotect light duty	ultraprotect heavy duty
		can aswell stitched as loose on the webbing	can only be stitched on a 2-ply web sling
30	2	UPLD-65	UPHD-65
30	4	UPLD-65	UPHD-65
50	2	UPLD-65	UPHD-65
50	4	UPLD-65	UPHD-65
60	2	UPLD-75	UPHD-75
60	4	UPLD-75	UPHD-75
75	2	UPLD-90	UPHD-90
75	4	UPLD-90	UPHD-90
90	2	UPLD-115	UPHD-115
90	4	UPLD-115	UPHD-115
100	2	UPLD-115	UPHD-115
100	4	UPLD-125	UPHD-125
120	2	UPLD-145	UPHD-145
120	4	UPLD-145	UPHD-145
125	2	UPLD-145	UPHD-145
125	4	UPLD-145	UPHD-145
150	2	UPLD-175	UPHD-175
150	4	UPLD-175	UPHD-175
180	2	UPLD-205	UPHD-205
180	4	UPLD-205	UPHD-205
200	2	UPLD-275	UPHD-275
200	4	UPLD-275	UPHD-275
250	2	UPLD-275	UPHD-275
250	4	UPLD-275	UPHD-275
300	2	UPLD335	UPHD-335
300	4	UPLD335	UPHD-335



Dyneema® is a registered trademark of Royal DSM N.V.

UPLD - 65 = (U)ltra(P)rotect (L)igth (D)uty 65 mm inside width

UP Protection sleeves



ULTRAPROTECT

ULTRAPROTECT PROTECTION SLEEVES FOR UNITEX ROUND SLINGS

“heavy duty uphd” and “light duty upld”



Tons	Over the single leg	Over both legs
1 t	UPLD-65 / UPHD-65	UPLD-65 / UPHD-65
2 t	UPLD-65 / UPHD-65	UPLD-65 / UPHD-65
3 t	UPLD-65 / UPHD-65	UPLD-65 / UPHD-65
4 t	UPLD-65 / UPHD-65	UPLD-75 / UPHD-75
5 t	UPLD-75 / UPHD-75	UPLD-75 / UPHD-75=tide / UPLD-90 / UPHD-90 =loose
6 t	UPLD-75 / UPHD-75	UPLD-90 / UPHD-90
8 t	UPLD-115 / UPHD-115	UP-90=fest / UPLD-115 / UPHD-115=lose
10 t	UPLD-115 / UPHD-115	UPLD-115 / UPHD-115
12 t	UPLD-115 / UPHD-115	UPLD-145 / UPHD-145
15 t	UPLD-125 / UPHD-125	UPLD-145 / UPHD-145
20 t	UPLD-125 / UPHD-125	UPLD-145 / UPHD-145=fest / 100 -UPLD-175 / UPHD-175=lose
25 t	UPLD-145 / UPHD-145	UPLD-175 / UPHD-175
30 t	UPLD-175 / UPHD-175	UPLD-220 / UPHD-220
35 t	UPLD-175 / UPHD-175	UPLD-220 / UPHD-220
40 t	UPLD-175 / UPHD-175	UPLD-220 / UPHD-220
50 t	UPLD-220 / UPHD-220	UPLD-275 / UPHD-275
60 t	UPLD-220 / UPHD-220	UPLD-275 / UPHD-275
70 t	UPLD-335 / UPHD-335	UPLD-335 / UPHD-335
80 t	UPLD-335 / UPHD-335	-
90 t	UPLD-335 / UPHD-335	-
100 t	UPLD-335 / UPHD-335	-

UPLD - 65 =(U)ltra(P)rotect (L)ight (D)uty 65 mm inside width

UPSP Corner protection

The ULTRAPROTECT Sling Protection is specially developed for round- and web slings in order to protect this lifting equipment against extreme abrasion or sharp edges.

The ULTRAPROTECT sling protection is made of the Dyneema® fibre, which makes the ULTRAPROTECT sling protection both very light, and extremely resistant against abrasion and sharp edges

Due to the firm Velcro closing this product is very practical in use and very quick to fit and adjust.

The Velcro closing enables the user to use one single ULTRAPROTECT sling protection for a various types round slings,(1 leg or 2 legs), web slings or other lifting equipment.

The ULTRAPROTECT sling protection is available in various sizes.

For extreme abrasion applications the light duty version is applicable. To protect the lifting slings against sharp edges the heavy duty is the perfect product.

Note: Avoid sliding of the load. Also ULTRAPROTECT can be cut through sliding.

ULTRAPROTECT SLING PROTECTION (UPSPLD)

Light duty

Type	inside width	max. Ø in mm
UPSPLD-65 mm	40 - 52,5 mm	33
UPSPLD-75 mm	50 - 62,5 mm	39
UPSPLD-90 mm	65 - 77,5 mm	41
UPSPLD-115 mm	65 - 90 mm	57
UPSPLD-125 mm	75 - 100 mm	63
UPSPLD-145 mm	95 - 120 mm	76
UPSPLD-175 mm	125 - 150 mm	95
UPSPLD-205 mm	155 - 180 mm	114
UPSPLD-275 mm	225 - 250 mm	159
UPSPLD-335 mm	285 - 310 mm	197



ULTRAPROTECT SLING PROTECTION (UPSPHD)

Heavy Duty

Type	inside width	max. Ø in mm
UPSPHD-65 mm	40 - 52,5 mm	33
UPSPHD-75 mm	50 - 62,5 mm	39
UPSPHD-90 mm	65 - 77,5 mm	41
UPSPHD-115 mm	65 - 90 mm	57
UPSPHD-125 mm	75 - 100 mm	63
UPSPHD-145 mm	95 - 120 mm	76
UPSPHD-175 mm	125 - 150 mm	95
UPSPHD-205 mm	155 - 180 mm	114
UPSPHD-275 mm	225 - 250 mm	159
UPSPHD-335 mm	285 - 310 mm	197

UPCP Corner protection



ULTRAPROTECT CORNER PROTECTION

Unitex has developed a new and unique flexible corner protection. This new flexible corner protection made out of a High Tech Dyneema® fiber adjusts itself almost 100% to the shape of the corner. The material is very cut and abrasion resistant.

The material used for the corner protection has proven itself already in our ULTRALIFT round slings especially on the ULTRALIFT UPNG coil sling.

ULTRAPROTECT CORNER PROTECTION FOR UNITEX ROUND SLINGS (UPCP)

Type	suitable for:	suitable for:	Type	Width A	Length B	Width C
	UNITEX ROUNDSLING	UNITEX WEBSLINGS		in mm	in mm	in mm
UPCP65/200	1,2 and 3 ton	30 mm	1	65	200	50
UPCP75/250	4,5 and 6 ton	60 mm	1	75	250	50
UPCP85/300		75 mm	1	85	300	50
UPCP100/300		90 mm	1	100	300	50
UPCP125/300	8 t	100- 120 mm	1	125	300	50
UPCP 135/300	10 t - 12 t	125 mm	1	135	300	50
UPCP155/500	15 t	150 mm	2	155	500	50
UPCP 185/600	20 t - 25 t.	180 mm	2	185	600	75
UPCP 215/600	30 t	200 mm	2	215	600	75
UPCP 230/800	35 t - 40 t		2	230	800	75
UPCP 285/800	45 t - 55 t	250 mm	2	285	800	100
UPCP 345/800	60 t - 65 t	300 mm	2	345	800	100
UPCP 370/800	70 t - 75 t		2	370	800	100
UPCP 430/800	80 t		2	430	800	100
UPCP 460/800	85 t		2	460	800	100
UPCP 540/800	90 t - 100 t		2	540	800	100
UPCP 690/800	125 t		2	690	800	100

Dyneema®
is a registered
trademark of
Royal DSM N.V.

UPCP - 215 =(U)ltra(P)rotect (C)orner (P)rotection 215 mm wid

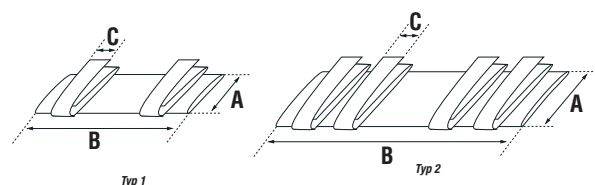

PU Technical information

MECHANICAL PROPERTIES

Distinguishing Characteristics	Measurements	dimensions	standard
Shore-A Hardness	80 ±3		DIN 53505
Tensile strength	20	N/mm ²	DIN 53504
Ultimate elongation	450	%	DIN 53504
Tear resistance	20	N/mm	DIN 53515
Attrition	60	mg	DIN 53516
Rebound elasticity	ca. 40	%	

CHEMICAL PROPERTIES

Chemical resistant on Unitex PU- protection material tested on a sample after 200 hours exposure at 20 degrees Celsius. Short time exposure has normally little influence and is not comparable for following data

	Concentration	degeneration of the mechanical Properties
Formic acid	2%	1)
	5 %	2)
	10 %	2)
Ammonia	5 %	1)
Boric acid	4 %	1)
chlorine-alkali	3 %	1)
acetic acid	2 %	1)
	5 %	2)
	10 %	2)
	50 %	3)
Formaldehyde	37%	3)
gerb acidic solution	20 %	1)
Potassium	20 %	3)
saline drip	10 %	1)
Linseed oil acid		1)
Methanol		3)
methyl chloride		3)

	Concentration	degeneration of the mechanical Properties
lactic acid	45 %	2)
Caustic Soda	10 %	2)
	40 %	2)
	50 %	3)
phosphoric acid	25 %	2)
	50 %	2)
hydrochloric acid	10 %	3)
nitric acid	10 %	1)
sulphuric acid	10 %	1)
	25 %	2)
	50 %	3)
Soda	20 %	2)
premium gasoline		3)
hydrogen peroxide	10 %	1)
xylene		3)
citric acid	10 %	3)
sugar solution	30 %	1)

- 1) = degeneration of the mechanical properties 0 - 5%
 2) = degeneration of the mechanical properties 5 - 15%
 3) = degeneration of the mechanical properties > 15%

PU Technical information

By using Unitex PU-protection the user still has his or her responsibility, care should be taken to ensure the safety of the lift and personnel during the lift

Unitex Pu-protection sleeve can be used between 0 up to 70 degrees celcius (for a short periode only between -40 and plus 100 degrees celcius)

- Maximum pressure allowed is 30N/mm²
- **Chemicals can effect the Polyurethane special attention is needed and the producer must be contacted**
- **Do not dry the sleeve by force**
- **store the Polyurtethane in a dry and ventilated room**

Please note that the Polyurethane can be damaged when goods start to slide through the sleeve. The user is always responsible for the correct use of the sling protected with a polyurtethane coating or sleeve

Purtecta Color

PU-COATING WITH COLOUR-CODE

PURTECTA colour web slings.... A new development by Unitex

PURTECTAcolor web slings is a combination of 2 special coatings. On one side (special for loads with sharp edges) the PURTECTA web slings have a thick and more extensive PU coating and the other side a special emulsion coating with a colour-code according to EN 1492-1 for an extra protection on abrasion

The PURTECTAcolor colour web slings are special for use under following circumstances:

1. + : Cut resistance combined with flexibility of the sling
2. + : Light in weight therefore easy to use
3. + : Extremely cut and abrasion resistant
4. + : Very mild gentle for the load (no damages)

A unique new innovation by Unitex to make protected slings easier and safer in use



PURTECTACOLOR - WEB SLINGS EN 1492-1

Type	colour-code according EN 492-1	WLL in t	colour-code according EN 492-1
BPTC-30	violet	1,0	30
BPTC-60	green	2,0	60
BPTC-90	yellow	3,0	90
BPTC-120	grey	4,0	120
BPTC-150	red	5,0	150
BPTC-180	brown	6,0	180
BPTC-240	blue	8,0	240
BPTC-300	orange	10,0	300
BPTC-300/3	orange	15,0	300
BPTC-300/4	orange	20,0	300
	pink	Intermediate	

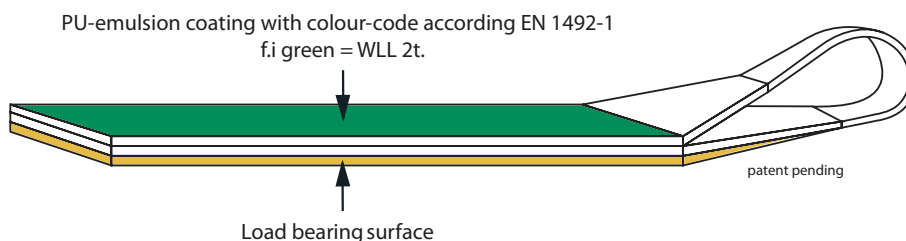

PU-Sleeve

DIMENSIONS

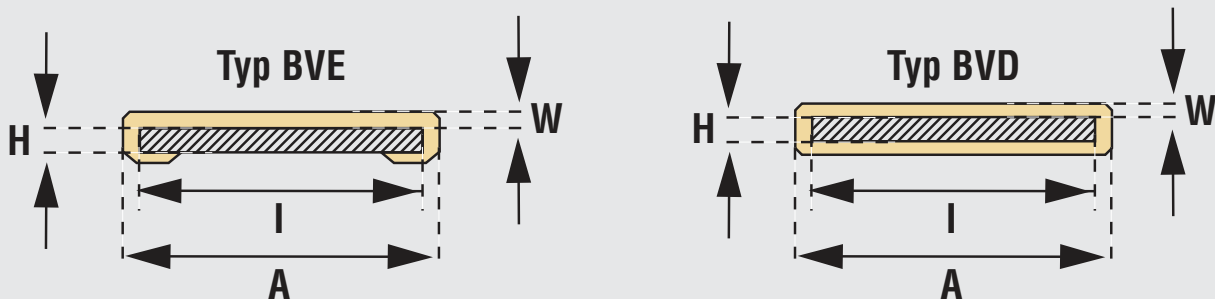

Typ	dimensions	for 2-ply webslings	for 4 ply webslings	for lashings	for roundslings 1 leg	for roundslings both legs
	A / I / H / W					
BVE oder BVD 35/12	45/35/12/5			25mm		
BVE oder BVD 40/10	50/40/10/5	30mm		35mm		
BVE oder BVD 40/20	50/40/20/5		30mm			
BVE oder BVD 50/12	60/50/12/5	40mm				
BVE oder BVD 60/4	66/60/4/3			50mm		
BVE oder BVD 60/12	70/60/12/5	50mm				
BVE oder BVD 60/17	70/60/17/5		50mm			
BVE oder BVD 70/12	80/70/12/5	60mm				
BVE oder BVD 75/17	85/75/17/5		60mm		2 t.	1 t.
BVE oder BVD 70/24	80/70/24/5		60mm			
BVE oder BVD 85/12	95/85/12/5	75mm		75mm		
BVE oder BVD 85/24	95/85/24/5		75mm		8 t.	2 t.
BVE oder BVD 100/12	110/100/12/5	90mm				
BVE oder BVD 100/17	110/100/17/5		90mm			3 t.
BVE oder BVD 100/24	110/100/24/5		90mm			
BVE oder BVD 110/12	120/110/12/5	100mm		100mm		
BVE oder BVD 120/17	130/120/17/5					
BVE oder BVD 120/36	130/120/36/5				10 t.	
BVE oder BVD 125/17	135/125/17/5		120mm			4 t.
BVE oder BVD 135/12	145/135/12/5	120mm				
BVE oder BVD 135/17	145/135/17/5		120mm			
BVE oder BVD 135/24	145/135/24/5		120mm			



PU-Sleeve

DIMENSIONS

Typ	dimensions	for 2-ply webslings	for 4 ply webslings	for lashings	for roundslings 1 leg	for roundslings both legs
	A / I / H / W					
BVE oder BVD 150/36	160/150/36/5				15 t.	
BVE oder BVD 150/48	160/150/48/5				20 t.	
BVE oder BVD 160/12	170/160/12/5	150mm				
BVE oder BVD 160/17	170/160/17/5		150mm			6 t.
BVE oder BVD 160/24	170/160/24/5		150mm			
BVE oder BVD 180/12	190/180/12/5					
BVE oder BVD 180/17	190/180/17/5					
BVE oder BVD 190/12	200/190/12/5	180mm				
BVE oder BVD 190/17	200/190/17/5		180mm			8 t.
BVE oder BVD 190/24	200/190/24/5		180mm			
BVE oder BVD 200/17	210/200/17/5					
BVE oder BVD 220/12	230/220/12/5	200mm				
BVE oder BVD 220/17	230/220/17/5		200mm			
BVE oder BVD 220/36	230/220/36/5					10 t.
BVE oder BVD 220/45	230/220/45/5					
BVE oder BVD 240/20	250/240/20/8					
BVE oder BVD 250/15	260/250/15/8	240mm				
BVE oder BVD 260/17	270/260/17/8	250mm				
BVE oder BVD 280/15	290/280/15/8					
BVE oder BVD 280/30	290/280/30/8		240mm			15 t.
BVE oder BVD 320/15	330/320/15/8	300mm				
BVE oder BVD 320/30	330/320/30/8		300mm			
BVE oder BVD 320/45	330/320/45/8					20 t.



Standard length in 2 and 4 meter

Prices will be charged on 0,5 meter length minimum length charged is 1 meter

extra for length under 2 meter 6%

extra for length between 2 and 4 meter 8%

extra for length from 4 meter up to maximum of 8 meter 12%

PU Coating

POLYURETHANE COATING

Available for webslings from 30mm up to 300mm in as well 1 and 2 sided coating
The thickness of the coating is 5mm
Please note: coating of 1 -ply webslings is not possible
Coating of endless liftings slings will have a surcharge of 24%

Please note: PU-coating is not suitable for turning sharp edges Objects
Even Unitex PU-protection can be damaged when goods start to slide on the sleeve or coating
The user is always responsible for the correct use of the sling protected with a polyurethane coating or sleeve

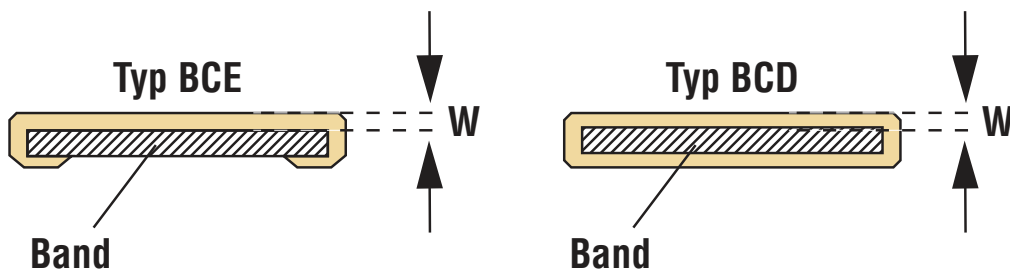

Special

webslings with D or DS fittings can be coated around the fittings in the way the fittings can still be moved or in such way the fittings will be fixed to the sling
Webslings with eyes can be coated into the eyes

POLYURETHANE SPRAY COATING

Available for webslings from 30mm up to 300mm in as well a 1 and 2 sided coating
The thickness of the coating is 0,5- 1mm
Lose webbing can be spray coated on rolls with a minimum length of 50 meter

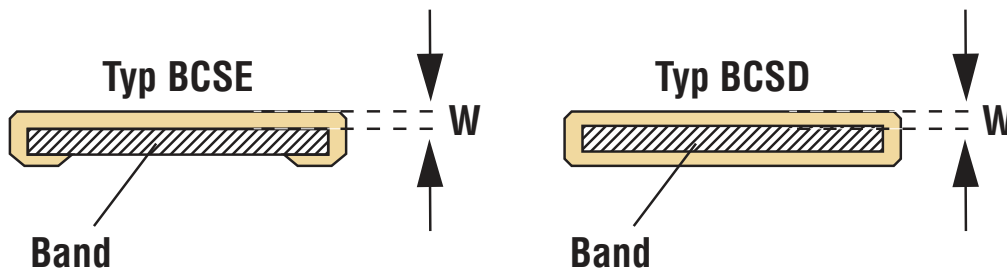

PU Cornerprotection

POLYURETHANE "KW" CORNER PROTECTION WITH OR WITH OUT MAGNETS

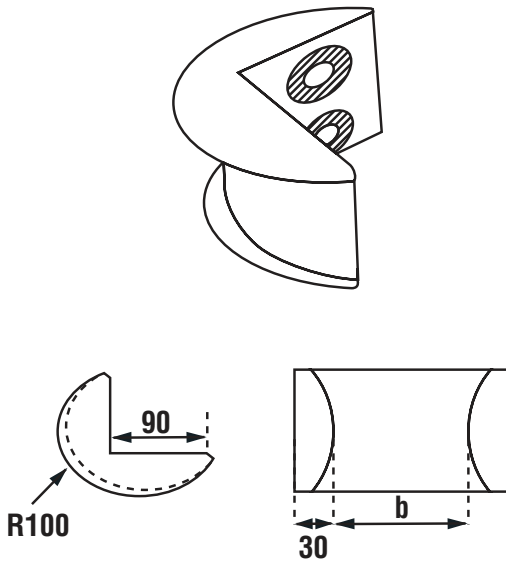

Type	for webbing width (b) in mm	number of magnets
KW025	25	2
KW040	40	2
KW065	65	2
KW075	75	4
KW100	100	4
KW125	125	4
KW150	150	4
KW200	200	6
KW300	300	8

Other sizes are available on demand

Type	for webbing width (b) in mm	number of magnets
KWLG060	60	2
KWLG090	90	2
KWLG150	150	4
KWLG300	300	8

UNITEX "KWL" CORNER PROTECTION

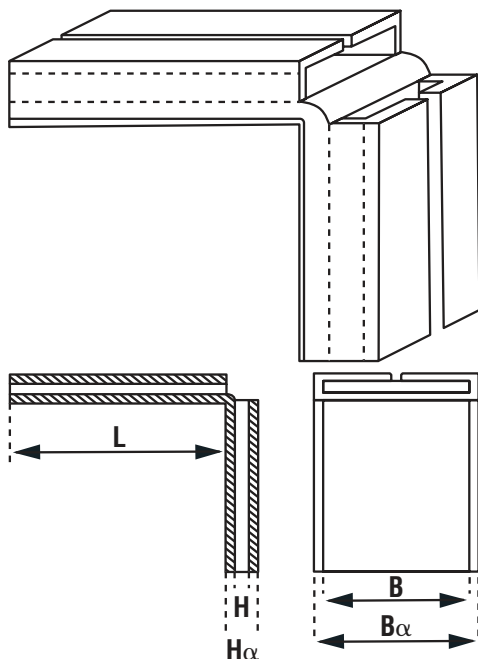

Type	for webbing width (b) in mm	L (mm)	B (mm)	Ba (mm)	H (mm)	Ha (mm)
KWL030	30	100	40	50	10	20
KWL060	60	100	70	80	12	30
KWL090	90	100	100	110	12	30
KWL120	120	100	135	145	12	30
KWL150	150	150	160	170	12	30
KWL180	180	150	190	200	12	30
KWL240	240	200	280	300	15	40
KWL300	300	200	320	340	20	45

Other sizes are available on demand

PU Cornerprotection

UNITEX 'KWL' CORNER PROTECTION

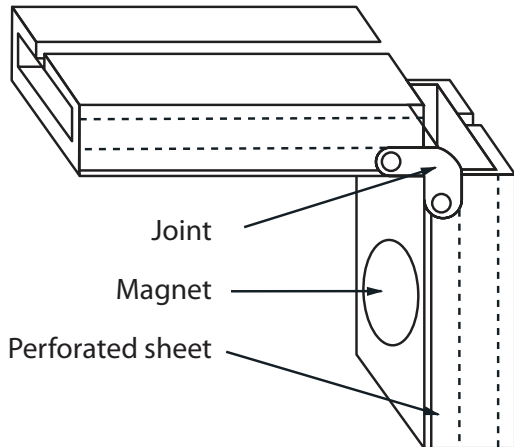

Type	for webbing width (b) in mm	number of magnets
KWLG060	60	2
KWLG090	90	2
KWLG150	150	4
KWLG300	300	8

Other sizes are available on demand

UNITEX "DF" CORNER PROTECTION

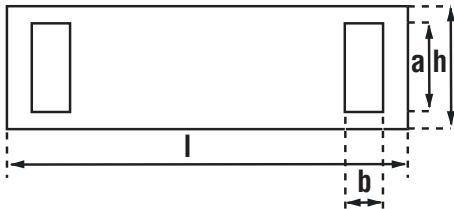

Type	Length x Width	opening a x b
DF025	250 * 80	25 * 10
DF035	250 * 80	35 * 10
DF055	300 * 100	55 * 10
DF060	450 * 100	60 * 30
DF070	450 * 120	70 * 30
DF080	450 * 120	80 * 30
DF090	470 * 130	90 * 40
DF100	470 * 150	100 * 40
DF110	470 * 150	110 * 40
DF130	470 * 170	130 * 40
DF160	470 * 200	160 * 40
DF200	470 * 240	200 * 40
DF220	470 * 240	220 * 40
DF250	500 * 280	250 * 40
DF320	600 * 400	320 * 40
DF420	600 * 500	420 * 40

Other sizes are available on demand

PU Chain Protection

PU CHAIN PROTECTION SLEEVE "BVC"

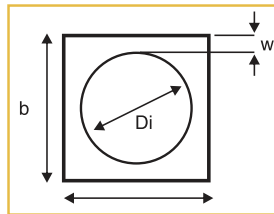

Type	Material Thickness w	Inside Diameter Di	outside dimensions a * b	for chain
BVC 22/12	5mm	12mm	22 * 22	
BVC 24/14	5mm	14mm	24 * 24	
BVC 25/15	5mm	15mm	25 * 25	
BVC 28/18	5mm	18mm	28 * 28	
BVC 30/20	5mm	20mm	30 * 30	
BVC 32/22	5mm	22mm	32 * 32	
BVC 36/26	5mm	26mm	36 * 36	6mm
BVC 38/28	5mm	28mm	38 * 38	
BVC 42/32	5mm	32mm	42 * 42	8mm
BVC 45/35	5mm	35mm	45 * 45	
BVC 52/42	5mm	42mm	52 * 52	10mm
BVC 55/45	5mm	45mm	55 * 55	
BVC 60/50	5mm	50mm	60 * 60	13mm
BVC 73/63	5mm	63mm	73 * 73	16mm
BVC 85/75	5mm	75mm	85 * 85	20mm
BVC 105/85	10mm	85mm	105 * 105	22mm
BVC 140/120	10mm	120mm	140 * 140	

Chain can be protected from damage whilst lifting sharp edged loads with UNITEX PU protective sleeves. UNITEX PU protective sleeves are made out of Polyurethane Elastomer, a material unique in its resistance to abrasion and cutting, thus offering optimal protection of the chain. High levels of grip on flat surfaces also prevent load slippage. A textile lining ensures that the inserted chain can glide easily through the sleeve.

Material:

Polyurethane Elastomer approx. 80 Shore A, 450% stretch capacity (DIN 53 504), further stretch capacity 20 N/mm (DIN 53 515), Abrasion 60mg (DIN 53 516).

PU CORNER PROTECTION "KSL"

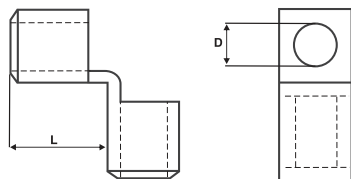

Type	Inside diameter D	Length L	Weight per pcs.
KWS 25	30mm	80mm	0,3 kgs
KWS 40	50mm	125mm	1,0 kgs

CORNER PROTECTION "KWS"

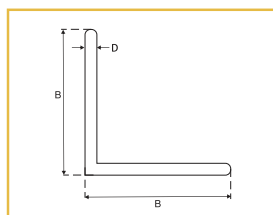

Type	dimensions			Weight (kg/m)
	B	D	L	
KSL.2.190.120.OR	190	19	1200	0,5
KSL.2.190.600.OR	190	19	6000	0,55

Technical Specifications:

width: 190 x 190

Material: Polypropylene

thickness: 19mm

Max. Length : 6 meter

Protection Sleeve

PVC PROTECTION SLEEVE BLUE



Type	Diameter in mm	Width in mm	for web slings	for round slings single leg (1)	for round slings both legs (2)
BS50BL	38	60	30-50mm	1-4 t	1-3 t
BS60BL	50	80	60mm	5-8 t	4-5 t
BS75BL	63	100	75-100mm		5-8 t
BS100BL	76	120		10 t	10 t
BS150BL	100	160	120-150mm	12-30 t	12-20 t
BS180BL	127	200	180mm	35-50 t	25-30 t
BS200BL	150	235	200mm	55-60 t	35-45 t
BS300BL	200	315	240-300mm	65-100 t	50-70 t

PU IMPREGNATED PROTECTION SLEEVE RED



Type	Diameter in mm	Width in mm	for web slings	for round slings single leg (1)	for round slings both legs (2)
BS50RE	38	60	30-50mm	1-4 t	1-3 t
BS60RE	52	82	60-75mm	5-8 t	4-5 t
BS75RE	75	118	75-100mm	10 t	5-10 t
BS150RE	102	160	120-150mm	12-30 t	12-20 t
BS180RE	125	196	180mm	35-50 t	25-30 t
BS200RE	152	239	200mm	55-60 t	35-45 t



UNITEX Height Safety contents

Company	Page	73
Full Body Harnesses	Page	74 - 75
Safety Lanyards	Page	76- 77
Height Safety Kits	Page	78
Fall Arrest Devices	Page	79 - 80
Karabiners & Connectors	Page	81 - 82
Belts and Work Positioning	Page	83
Confined Access, Rescue and Evacuation Equipment	Page	84
Storage Solutions and Miscellaneous	Page	85

UNITEX Height Safety the company

The Company

Unitex manufacturing group has for over 70 years been at the forefront of technological developments in the design and production of innovative safety webbings from automotive seat belt to the one-piece woven airbag.

The Equipment

Using the latest Computer Aided Design techniques coupled with the development of prototypes through the use of rapid prototyping methods, Unitex is able to combine new designs with tried and tested components benefiting the end user with improved functionality and the knowledge that Unitex's products give absolute security.

The Approach

Height safety has diverse and evolving needs and it's because of this and the increasing pressures legislation is placing on the industry that Unitex boasts some of the most experienced safety professionals.

Unitex is one of only a few companies offering a complete solution approach to it's customers, with tailored systems designed to meet individual customer needs.



Full Body Harnesses

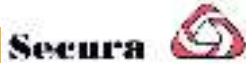

Harnesses are the foundation of all fall protection systems, and it's because of this that Unitex, have developed a dynamic and functional range of harnesses which allow unparalleled performance and comfort.

Unitex offers it's range of harnesses with **water repellent webbing** and **rip stitch indicators** as standard. Every harness is fully adjustable allowing quick and easy adjustment using fittings made from a high tensile alloy.



RGH1

EN361

45mm water repellent webbing
Rear attachment point Rip
stitch indicators Fittings made
from high tensile steel alloy
1.05kg



RGH4

EN361 and EN358

45mm water repellent webbing
Front, rear,side attachment Rip
stitch indicators Fittings made
from high tensile steel alloy
Gear loops 1.90kg



RGH2

EN361

45mm water repellent webbing
Front and rear attachment Rip
stitch indicators Fittings made
from high tensile steel alloy
1.20kg



RGH5

EN361 and EN1497

45mm water repellent webbing
Rear and front attachment points
Rip stitch indicators Fittings
made from high tensile steel alloy
Rescue strap 1.25kg



RGH3

EN361 and EN358

45mm water repellent webbing
Rear and side attachment Rip
stitch indicators Fittings made
from high tensile steel alloy Gear
loops 1.70kg



RGH9

EN361

45mm elasticated leg straps -
water repellent webbing Rear
and front attachment points Rip
stitch indicators Fittings made
from high tensile steel alloy
1.30kg

Full Body Harnesses

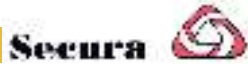

RGH11
EN358 and EN361
Multi-functional harness Front and rear attachment
Work positioning D rings
Rip stitch indicators
Water repellent webbing
Four sizes available
Weight 2.05kg



RGH12
EN361
Quick connect harness
Front and rear attachment
Rip stitch indicators
Water repellent webbing
Sit support strap
Weight 1.60kg



RGH16
EN358,361 and 813
Multi-task comfort harness
Ventral front D sit suspension
Rear and side attachment
Rip stitch indicators
Gear loops
Quick connect buckles
Weight 2.05kg



RGH18
EN361
Fully elasticated harness
Rear attachment
Rip stitch indicators
Weight 1.20kg



RGH31
EN361
Economy harness
Rear attachment
Water repellent
Weight 0.90kg



RGH32
EN361
Economy harness
Rear and front attachment
Water repellent
Weight 0.90kg



RGHE
EN361
Economy harness
Rear attachment
Water repellent
Weight 0.75kg



Comfort pad – fits most harnesses



Comfort leg pad – fits most harnesses



Parking loop – allows safe stowage of lanyard

Safety Lanyards

Connecting your harness to the anchor point

It's this crucial link that is often compromised by operators who routinely work in difficult areas, subjecting the lanyard to a variety of abrasive surfaces which may have a detrimental effect.

Unitex's response is to offer a complete range of lanyards including webbing, rope and chain to ensure maximum choice, flexibility and most important of all, safety.



RGL1
EN354 and EN355
44kN polyester webbing Length 1.3m and 1.8m Shock absorber pack Maximum arrest force <6kN



RGL4
EN354
450mm extension strop



RGL2
EN354 and EN355
12mm Kernmantel rope Length 1.3m and 1.8m Shock absorber pack Maximum arrest force <6kN

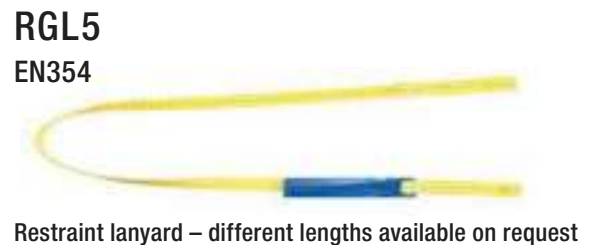

RGL5
EN354
Restraint lanyard – different lengths available on request



RGL3
EN354 and EN355
Twin leg lanyard 44kN polyester webbing Length 1.3m and 1.8m Shock absorber pack Maximum arrest force <6kN



RGL6
EN354 and EN355
lasticated construction
Length 1.3m and 1.8m
Shock absorber pack
Maximum arrest force <6kN



RGL7
EN355
Standard shock pack complete with delta links

Safety Lanyards



RGL10
EN354 and EN355
Special mining fall arrest chain lanyard Alloy steel to EN818-4 Length 1.8m



RGL11
EN355
Fall arrest utility lanyard 12mm kernmantel rope Length 1.7m



RGL12
EN354
Adjustable restraint lanyard 27mm 40kN polyester web Steel adjuster Length 1-2m



RGL13
EN354 and EN355
Adjustable fall arrest lanyard 27mm 40kN polyester web Steel adjuster Length 0.9-1.3m and 1.2-1.8m

RGL14
EN354
Twin leg restraint Lanyard 27mm 40kN web Length on request



RGL16
EN354/355
Adjustable twin leg fall arrest lanyard 27mm 40kN web Length 0.9-1.3m and 1.2-1.8m



RGL17
EN354
Twin leg rope restraint lanyard Length on request



RGL19
EN354
Adjustable twin leg restraint Lanyard Length on request



RGL20
EN354 and EN355
Kinetic fall arrest lanyard Length 1.3 and 1.8m

Height Safety Kits

Unitex's range of height safety kits are designed for multiple applications. Each complete kit consists of a full body harness, a shock absorbing lanyard or restraint lanyard (or fall arrest system- RGHK3) and the connectors you need to ensure safe working at height conditions at all time.

Every kit can be supplied either in a tough plastic container or a range of bags including pump bag or rucksack, making it easy to keep all your height safety equipment close at hand and in one place!



RGHK1

Includes

2 point harness (RGH2) 1.8m shock absorbing lanyard (RGL1) with karabiner (RGK1)



RGHK2 and RGHK4

Includes

2 point harness (RGH2) 1.8m shock absorbing lanyard (RGL1) with scaffold hook (RGK11) RGHK4 is supplied with the twin leg lanyard version (RGL3)



RGHK3

Includes

2 point harness (RGH2) 1.8m shock absorbing lanyard (RGL1) with karabiner (RGK11) 2.5m fall arrest block (RGA1) 1m anchorage sling (RGK26)



RGHK5

Includes

Single point harness (RGH1) and 2m restraint lanyard (RGL12) RGHK5/IPAF 2 point harness (RGH2) 1.5m adjustable restraint lanyard (RGL12) with karabiner (RGK1)

Fall Arrest Devices

When we designed our fall arrestors we had a number of key objectives....

Our benchmark goal was to design a state of the art fall arrestor which had increased functionality, was robust enough for all environments and was a fail safe design.

The attention to detail of our design and test teams has produced a streamlined and ergonomic range of all arrest blocks.

Using the latest 3D computer modelling techniques, features such as the handle have been optimised for strength and use, even with a gloved hand.



RGA1 EN360

Retractable mini web block
Working length 2.5m
47mm polyester webbing
Built in shock pack
L100 x W110 x D75 (mm)
Max arrest force < 6kN
Weight 1.4kg



RGA2 and 3 EN360

Multi purpose fall arrest block
Working length 10m & 15m
5mm steel wire rope
Fall indicating connector
L325 x W200 x D80 (mm)
L340 x W228 x D80 (mm)
Max arrest force < 6kN
Weight 6.5kg and 10.5kg



Xcalibre



RGA4

EN360 & EN1496 A & B
15m 3-way retrieval block
5mm steel wire rope
Fall indicating connector
L340 x W258 x D80 (mm)
Max arrest force < 6kN
Weight 11.35kg



RGA4B

The RGA4B bracket when fitted to the RGR1 tripod enables the RGA4 3 way retrieval block to be safely attached.
Material – steel
Weight 1.4kg



RGA5 EN360

Retractable mini web block
Working length 5.0m
28mm polyester webbing
Rip stitch indicator
L170 x W120 x D75 (mm)
Max arrest force < 6kN
Weight 2.0kg



RGA26 EN360

Low weight fall arrest block
Working length 6.0m
5mm steel wire rope
Fall indicating connector
L285 x W180 x D80 (mm)
Max arrest force < 6kN
Weight 5.2kg

Xcalibre is the latest generation Fall Arrest Block from Unitex.

The Xcalibre3w offers the ultimate answer in safety when working at low levels due to its unique rapid braking system (RBS).

Packed with unrivalled technology, super light and finished with a sleek, compact and contemporary design.

Ideal for working in the construction, off shore, port safety and rigging industries.

Xcalibre

Join the revolution

Fall Arrest Devices



RGA7
EN360
Multi-purpose fall arrest block – 33m



RGA8
EN360 & 341
Multi-purpose fall arrest block – 33m complete with autodescent feature



RGA9
EN360
3 way retrieval rescue fall arrest block – 33m



RGA10R
EN352/2
16mm nylon rope spliced at 1 end available in 10, 20, 30m



RGA12R
EN352/2
11mm kernmantel rope available in 10, 20, 30m



RGA16E
EN353/2
16mm nylon rope supplied with splice both ends



RGA10
EN353/2
Steel rope grab for 16mm rope



RGA11
EN353/2
8mm wire rope grab



RGA12
EN353/2
11mm kernmantel rope grab



RGA14
EN353/2
Rocker rope grab to be used with 10.5-12.7mm kernmantel rope



RGR/Tri-pulley
EN12278
Tri-pulley block to be used with RGR1 tripod

Karabiners & Connectors

These simple devices are often overlooked but should never be taken for granted. You will depend on them countless times during a normal day, but how much thought do you really give them. Let Unitex offer you both the advice and choice you need.

Unitex's range of karabiners and connectors is unsurpassed and the most comprehensive available and this is for a reason. Different applications and environments demand a specific solution and Unitex are there to bridge that technical gap.



RGK1
EN362
Material - steel
Gate opening – 19mm
Size – 108mm x 58mm
Closure type – screw gate
MBS – 25kN
Weight – 162g



RGK2
EN362
Material - steel
Gate opening – 17mm
Size – 108mm x 58mm
Closure type – twist lock
MBS – 25kN
Weight – 197g



RGK3
EN362
Material - steel
Gate opening – 22mm
Size – 125mm x 90mm
Closure type – twist lock
MBS – 40kN
Weight – 276g



RGK4
EN362
Material - aluminium
Gate opening – 25mm
Size – 125mm x 90mm
Closure type – twist lock
MBS – 28kN
Weight – 85g



RGK5
EN362
Material - steel
Gate opening – 55mm
Size – 235mm x 130mm
Closure type – twist lock
MBS – 35kN
Weight – 751g



RGK6
EN362
Material - aluminium
Gate opening – 53mm
Size – 235mm x 130mm
Closure type – twist lock
MBS – 23kN
Weight – 348g



RGK7 & RGK8
EN362
Material – stainless steel
Gate opening – 105/140mm
Size – 400/400mm x
175/200mm
Closure type – self spring
MBS – 22kN
Weight – 300/400g



RGK9
EN362
Material - alloy
Gate opening – 22mm
Size – 108mm x 58mm
Closure type – screw gate
MBS – 25kN
Weight – 157g

Karabiners & Connectors



RGK10

EN362

Material - steel
Gate opening – 20mm
Size – 155mm x 60mm
Closure type – double action
MBS – 22kN
Weight – 300g



RGK11

EN362

Material - aluminium
Gate opening – 60mm
Size – 255mm x 112mm
Closure type – double action
MBS – 22kN
Weight – 473g



RGK12

EN362

Material - steel
Gate opening – 11mm
Size – 70mm x 55mm
Closure type – screw
MBS – 22kN
Weight – 86g



RGK13

EN362

Material - steel
Gate opening – 14mm
Size – 105mm x 58mm
Closure type – screw gate
MBS – 30kN
Weight – 174g



RGK13P

EN362

Material – steel
Gate opening – 14mm
Size – 105mm x 58mm
Closure type – screw gate
MBS – 30kN
Weight – 176g



RGK14

EN362

Material - steel
Gate opening – 24mm
Size – 112mm x 65mm
Closure type – triple action
MBS – 45kN
Weight – 266g



RGK16

EN362

Material - steel
Gate opening – 18mm
Size – 130mm x 70mm
Closure type – twist lock
MBS – 40kN
Weight – 300g



RGK17

EN362

Material – light alloy
Gate opening – 18mm
Size – 130mm x 60mm
Closure type – double action
MBS – 25kN
Weight – 150g



RGK27

EN795B

Material - steel
Gate opening – N/A
Size – 210mm x 60mm
Closure type – plunger
MBS – N/A
Weight – 550g

Belts and Work Positioning

It is not always possible to carry out the tasks using work restraint. In these cases whether it be due to the nature of the work area or the task actually being carried out, Unitex have developed the most comprehensive range of work positioning products, allowing the operator total freedom of movement.

Depending on the actual application Unitex can offer both webbing belts and rope/wire products to suit your individual needs.

RGB1
EN358



Twin D work positioning restraint belt

RGB2
EN358



Work positioning restraint belt
Alternative buckle and gear loops

RGBE-TA
EN358



Work positioning belt with 2 attachment restraint points and 2 gear loops

RGBE
EN358



Work positioning restraint belt with rear attachment point

RGB180-BT
EN358



Work positioning belt with 2 attachment restraint points and 2 gear loops

RGP1
EN358



Work positioning belt with 2 attachment restraint points and 2 gear loops

RGP2
EN358



Work positioning belt with 2 attachment restraint points and 2 gear loops

RGP3
EN358



Work positioning belt with 2 attachment restraint points and 2 gear loops

RGP4
EN358



Work positioning belt with 2 attachment restraint points and 2 gear loops

RGP11
EN358



Work positioning belt with 2 attachment restraint points and 2 gear loops

Confined Access, Rescue and Evacuation Equipment



RGR1
EN795
 Unique elliptical design preventing twisting Height range 1.68m-2.67m Span diameter of 1.80m SWL 200kg
 Weight 17.60k



RGR3
VRS RESCUE SYSTEM
 Alloy pulleys and 11mm kernmantel rope Safe for rescuer SWL 136kg – 1 person only
 Weight 18kg in combination with 80m rope



RGR4
Draft 95/501316
 Escape and rescue system Steel descender with 11mm nylon kernmantel rope. 60mm scaffold hook SWL 200kg 1 or 2 persons
 Weight 0.55kg descender



RGR8
EN341
 9mm rope or combination For persons up to 150kg Descent rate 1.5m/second Proof tested to 1,200kg Weight 2.95kg
 Available up to 100m



RGR10
EN341
 Designed tubular webbing Ultra compact and lightweight Weight 1.00kg in combination with 40m of webbing
 Available up to 80m



RGR11
 Quick and easy method to ascend or descend to a position of safety –
 weight 6.15kg

RGK42



Trauma suspension straps – fit to all harnesses

RGR7
EN1496 A+B



50 metre tripod winch

RGR9
EN341



Descender unit

Storage Solutions and Miscellaneous



RGK22

Tool frog for fitting to harness



RGK23

Tool frog for fitting to harness



RGK24

Standard holdall for safe storage



RGK24/C

Standard kit box



RGK24/P

Pump bag



RGK24/R

Ruck sack



RGK29

Tripod bag



RGK30

Winch bag for use with RGR7



RGK32

Rope bag



RGK25/11

Rope protective sleeve



RGK25/16

rope protective sleeve



RGH6

Rescue triangle



RGBT1

Beam trolley 75-200mm flange



RGHL1

Temporary horizontal lifeline – 10m and 20m EN795 class C



RGK26

Girder sling – standard length 1, 2 and 4m – can be made specific length – EN795



RGJ1

Reflective jacket For all Unitex harnesses

contents



Introduction	Page	87 -88
TS / STS	Page	89
TSMP / STSMP	Page	90
TSU / STSU	Page	91
TSEU-A and TSU-R	Page	92
TSHP and TSHPU	Page	93
TNMK and TNMKA	Page	94
FBK / TOBK	Page	95
TJP / TCK	Page	96
FHX / FHSX	Page	97
TDH	Page	98
THSK	Page	99
FHX-V and TNMH	Page	100
TPH	Page	101
FSV / FSVW	Page	102
TSCC	Page	103
TBS	Page	104
TBC and TBCA	Page	105
TVK and TVKH	Page	106
VERTICAL CLAMPS WITH AN EXTRA HARDENED PIVOT AND CAM	Page	107
STELCON PLATEHOOKS and TRC	Page	108
TTL / TBLC	Page	109
SPARE PARTS	Page	110
SPARE PARTS TS / STS	Page	111
SPARE PARTS TSMP / STSMP	Page	112
SPARE PARTS TSU / STSU	Page	113
SPARE PARTS TSHP(U)	Page	114
SPARE PARTS FH(S)X	Page	115
SPARE PARTS FSV(W)	Page	116
SPARE PARTS TPH	Page	117
SPARE PARTS TBLC	Page	118
SPARE PARTS HARDOX	Page	119
SPARE PARTS SETS	Page	120
Safely lifting vertical	Page	121
Safely lifting horizontal	Page	122

introduction



Design

- Compact design and a low own weight.
- Use of top quality steel for housing, lifting shackle, cam and pivot guarantees a high level of usage and a long life.

Quality

- Very good quality and finish.
- Usage of "Exotic" steel for cam and pivot.
- Simple construction, therefore easy to repair.
- All lifting clamps are tested on our own testing facilities up to 2 times its Safe Working Load (SWL).
- Each clamp is supplied with a test certificate.

General

- Always read the manual before using a clamp.
- The lifting clamps are suitable for lifting and transporting of steel plates with a maximum hardness of 37 Hrc (345 HB, 1166 N/mm²).
- The lifting clamps are suitable for usage in normal atmospheric conditions, between -40°C and +100°C.
- Never overload a clamp and prevent the jerking of loads.
- When loading always use the whole jaw depth.
- Never lift more than one plate at the same time.
- Always keep your distance during lifting and descending of a load.
- Prevent situations that anybody is under the load.
- Any welding to the clamp is forbidden, this can influence the hardness and toughness of the clamp.

Delivery

- All lifting clamps are supplied with an original certificate.
- All lifting clamps conform to European Standards according to Machine Directive 98/37/EC.
- All lifting clamps have been approved after stringent test by Government Safety Authorities (No. AI: 2753A).

Terrier introduction

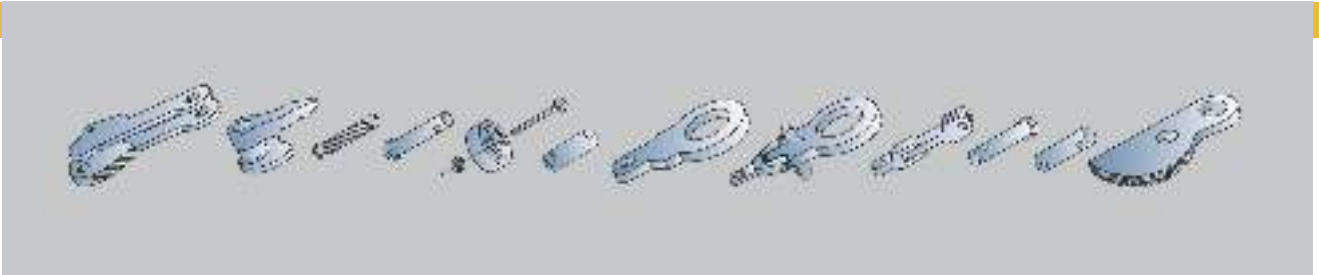

Terrier Lifting Clamps provides a 5 year warranty on its lifting clamps. This warranty is applicable to the original end user of the lifting clamps. Only if the clamp has been inspected, checked and maintained by this instructions and by an official dealer. This warranty period of 5 years is valid from the day of purchase, and is liable to all conditions and measurements stated in this document.

1. Conditions

This warranty only covers failures in the lifting tools which is the consequence of production errors which occur during normal use. The warranty covers no wear to components such as pivots, cam assemblies, lock springs etc. Should there be any kind of failure within this guarantee period, the lifting tool will be replaced or repaired to insight of the producer.

No warranty is given to clamps due to the following failures:

- Regular wear
- Overload
- Wrong and/or carelessly use
- Damages
- Not following procedures and measures
- Hoisting differing material other then indicated on clamp or stated in the user-manual
- Adapting and/or modifying of the Terrier clamp
- The injudicious use of the clamp, and not succeeding all indications which are stated in the users manual
- When maintenance and/or revision has not been carried out by an authorised Terrier distributor

The producer is not responsible for incidental damage or damage due to use of the lifting tools as well as from violation of this guarantee manual.

2. Procedure Safety Inspection

All inspections and repairings must be written down in the maintenance diagram. This counts not only for your own inspections but also for inspections which are carried out by your authorised Terrier distributor. When the clamp is handed in for maintenance and inspection you always must provide the maintenance diagram.

Defective Lifting Clamps

When a form of wear or damage is indicated, you must take the following measures.

- 1 Take the lifting clamp out of use. (Note the date of failure of the lifting clamp)
- 2 Try to recover the cause of the failure, for example (complete list is available in chapter 1):
 - Overload
 - Wrong and/or carelessly use
 - etc

These claims stated in no.2 do not fall under the guarantee! To guarantee the security of you and your colleagues you are obliged to follow up this procedure.

- 3 Return your lifting clamp (with the maintenance history) to your authorised Terrier distributor.
- 4 If the lifting clamp has been revis

TS/STS

- For vertical lifting and transporting of steel plates and structures.
- The TS/STS lifting clamps are equipped with a safety mechanism, ensuring the clamp does not slip when lifting force is applied and when load is being lowered.
- The clamp is locked in closed as well as in open position.-Lifting capacity and jaw opening are clearly engraved in the body.
- Type STS are supplied with enlarged jaw opening.

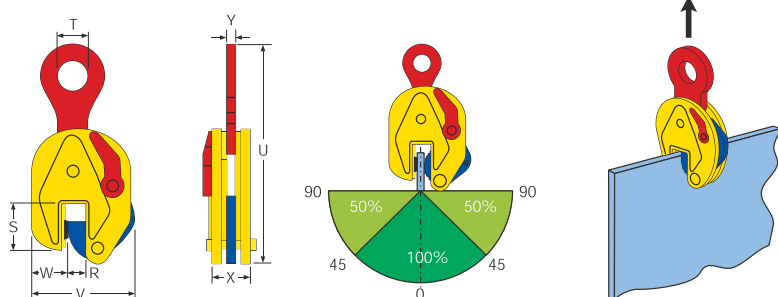

Ref. nr.	Type	Capacity(kg)	Jawopening (R) (mm)	Dimensions in mm							Weight(kg)
				S	T	U	V	W	X	Y	
54A010075A	0.75 TS	750	0 - 13	47	30	205	100	35	37	10	1,5
54A010100A	1 TS	1000	0 - 18	55	45	265	125	38	47	15	3,3
54A020100A	1 TSE	1000	0 - 25	55	45	265	142	38	47	15	3,6
54A010150A	1.5 TS	1500	0 - 20	80	65	335	165	55	56	17	6,3
54A020200A	2 TSE	2000	0 - 35	80	65	335	185	55	56	17	6,5
54A020300A	3 TS	3000	0 - 35	80	65	335	185	55	56	17	6,7
54A010450A	4.5 TS	4500	0 - 25	85	70	430	200	60	77	20	14,8
54A020450A	4.5 TSE	4500	0 - 45	85	70	430	230	60	77	20	15,9
54A010600A	6 TS	6000	0 - 32	114	75	490	225	78	78	20	18,6
54A010750A	7.5 TS	7500	0 - 40	112	75	530	245	76	86	20	24
54A020750A	7.5 TSE	7500	0 - 55	112	75	530	267	70	86	20	25
54A010900A	9 TS	9000	0 - 55	112	75	530	267	70	86	20	26
54A011200A	12 TS	12000	0 - 52	148	85	617	295	100	94	44	42
54A011500A	15 TS	15000	0 - 76	159	86	760	375	135	105	50	71
54A011700A	17 TS	17000	0 - 76	159	86	760	375	135	105	50	71
54A012000A	20 TS	20000	0 - 80	195	100	880	465	150	140	66	140
54A012500A	25 TS	25000	5 - 85	195	100	880	465	150	140	66	140
54A013000A	30 TS	30000	10 - 90	195	100	880	465	145	140	66	145
54A030600A	6 STS	6000	40 - 90	115	75	490	275	70	78	20	15
54A030750A	7.5 STS	7500	50-100	110	75	525	315	70	82	20	26
54A030900A	9 STS	9000	50-100	110	75	525	315	70	82	20	27
54A031200A	12 STS	12000	50-100	153	86	615	345	100	94	44	46
54A031500A	15 STS	15000	80-150	175	86	755	450	136	106	50	77
54A032000A	20 STS	20000	80-150	185	100	875	640	153	140	66	145
54A032500A	25 STS	25000	80-150	185	100	875	640	153	140	66	145
54A033000A	30 STS	30000	80-150	185	100	880	640	153	155	62,5	148

TSMP/STSM

- The Terrier lifting clamps TS and STS are also available in MP-version.
- MP-version means that the lifting shackle has a three way articulated linkage arrangement.
- For lifting and transporting of all steel plates and structures.
- When attached to a fixed load bearing arm (e.g. spreader bar) the clamp will retain its flexibility and no chain is needed.
- Due to length of the three way linkage arrangement the clamp can be lowered further between standing plates or structures.
- Lifting capacity and jaw opening are clearly engraved in the body.
- Type STSM is supplied with an enlarged jaw opening.

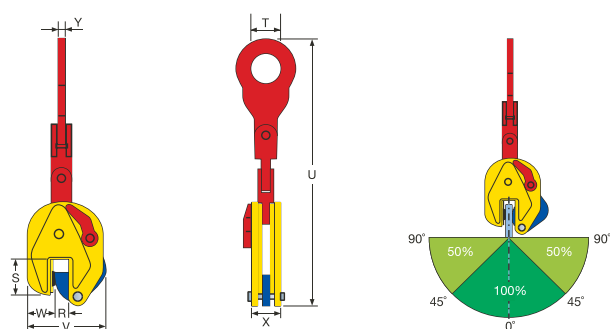

Ref. nr.	Type	Capacity(kg)	Jawopening (R) (mm)	Dimensions in mm							Weight(kg)
				S	T	U	V	W	X	Y	
54A040075A	0.75 TSMP	750	0 - 13	47	30	310	100	35	37	10	2
54A040100A	1 TSMP	1000	0 - 18	55	45	405	125	38	47	15	4,2
54A050100A	1 TSEMP	1000	0 - 25	55	45	405	142	38	47	15	4,5
54A040150A	1.5 TSMP	1500	0 - 20	80	65	515	165	55	56	17	7,6
54A050200A	2 TSEMP	2000	0 - 35	80	65	515	185	55	56	17	7,7
54A050300A	3 TSEMP	3000	0 - 35	80	65	515	185	55	56	17	8
54A040450A	4.5 TSMP	4500	0 - 25	85	70	655	200	60	77	20	18,1
54A050450A	4.5 TSEMP	4500	0 - 45	85	70	655	230	60	77	20	19,2
54A040600A	6 TSMP	6000	0 - 32	114	75	760	225	78	78	20	22,8
54A040750A	7.5 TSMP	7500	0 - 40	112	75	800	245	76	86	20	28
54A050750A	7.5 TSEMP	7500	0 - 55	112	75	800	267	70	86	20	30
54A040900A	9 TSMP	9000	0 - 55	112	75	800	267	70	86	20	32
54A041200A	12 TSMP	12000	0 - 52	148	85	860	295	100	94	26	46
54A041500A	15 TSMP	15000	0 - 76	159	86	980	373	136	106	50	79
54A041700A	17 TSMP	17000	0 - 76	159	86	980	373	136	106	50	79
54A042000A	20 TSMP	20000	0 - 80	195	100	1200	465	150	140	66	158
54A042500A	25 TSMP	25000	5 - 85	195	100	1200	465	150	140	66	158
54A060600A	6 STSM	6000	40 - 90	115	75	760	275	70	78	20	24
54A060750A	7.5 STSM	7500	50-100	110	75	800	315	70	82	20	28
54A060900A	9 STSM	9000	50-100	110	75	800	315	70	82	20	30
54A061200A	12 STSM	12000	50-100	153	85	860	345	100	94	26	47
54A061500A	15 STSM	15000	80-150	175	90	980	450	136	106	50	82
54A062000A	20 STSM	20000	80-150	185	100	1200	640	153	140	66	161
54A062500A	25 STSM	25000	80-150	185	100	1200	640	153	140	66	161

TSU/STSU

- For lifting and transporting of steel plates and structures from all positions (horizontal, vertical and sidelong).
- Articulated lifting shackle.
- The TSU /STSU lifting clamps are equipped with a safety mechanism, ensuring the clamp does not slip when lifting force is applied and when load is being lowered.
- The clamp is locked in closed as well as in open position.
- Lifting capacity and jaw opening are clearly engraved in the body.
- Type STSU is supplied with enlarged jaw opening.

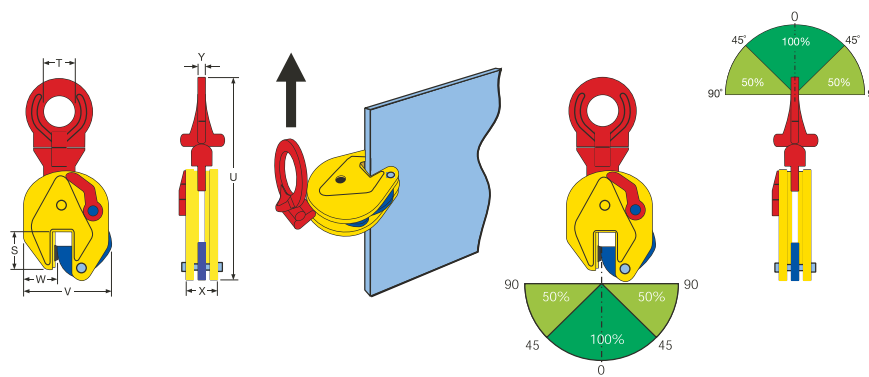

Ref. nr.	Type	Capacity(kg)	Jawopening (R) (mm)	Dimensions in mm							Weight(kg)
				S	T	U	V	W	X	Y	
54A070075A	0.75 TSU	750	0 - 13	47	30	203	100	35	37	10	1,7
54A070100A	1 TSU	1000	0 - 18	55	50	295	125	38	47	14	3,5
54A080100A	1 TSEU	1000	0 - 25	55	50	295	142	38	47	14	3,9
54A070150A	1.5 TSU	1500	0 - 20	80	70	370	165	55	56	16	7,2
54A080200A	2 TSEU	2000	0 - 35	80	70	370	185	55	56	16	7,3
54A080300A	3 TSEU	3000	0 - 35	80	70	370	185	55	56	16	7,5
54A070450A	4.5 TSU	4500	0 - 25	85	70	430	200	60	77	20	15,6
54A080450A	4.5 TSEU	4500	0 - 45	85	70	430	230	60	77	20	16,7
54A070600A	6 TSU	6000	0 - 32	114	78	527	225	78	78	32	21
54A070750A	7.5 TSU	7500	0 - 40	112	78	565	245	76	86	32	26
54A080750A	7.5 TSEU	7500	0 - 55	112	78	565	267	70	86	32	30
54A070900A	9 TSU	9000	0 - 55	112	78	565	267	70	86	45	32
54A071200A	12 TSU	12000	0 - 52	148	85	650	295	100	94	48	45
54A071500A	15 TSU	15000	0 - 76	159	85	765	373	136	106	48	75
54A071700A	17 TSU	17000	0 - 76	159	85	765	373	136	106	48	77
54A072000A	20 TSU	20000	0 - 80	195	100	900	465	150	140	71	145
54A072500A	25 TSU	25000	0 - 85	195	100	900	465	150	140	71	148
54A073000A	30 TSU	30000	0 - 90	195	100	900	465	145	140	71	150
54A090600A	6 STSU	6000	40 - 90	115	75	527	275	70	78	20	32
54A090750A	7.5 STSU	7500	50-100	110	75	565	315	70	82	20	28
54A090900A	9 STSU	9000	50-100	110	75	565	315	70	82	20	28
54A091200A	12 STSU	12000	50-100	153	86	650	345	100	94	44	45
54A091500A	15 STSU	15000	80-150	175	86	765	450	136	106	50	80
54A092000A	20 STSU	20000	80-150	185	100	900	640	153	140	66	150
54A092500A	25 STSU	25000	80-150	185	100	900	640	153	140	66	150
54A093000A	30 STSU	30000	80-150	185	100	900	640	153	155	62,5	155

TSEU-A and TSU-R

TSEU-A

- Only 1 clamp needed for different kind of jobs.
- Also the same clamp can be used if a big jaw opening is necessary.
- For lifting and transporting of steel plates and structures from all positions.
- Jaw opening from 0 - 95 mm. Adjustable by steps of 0-35 / 30-60 / 60-95 mm.
- Capacity 3000 kg.
- Strong and lightweight construction.

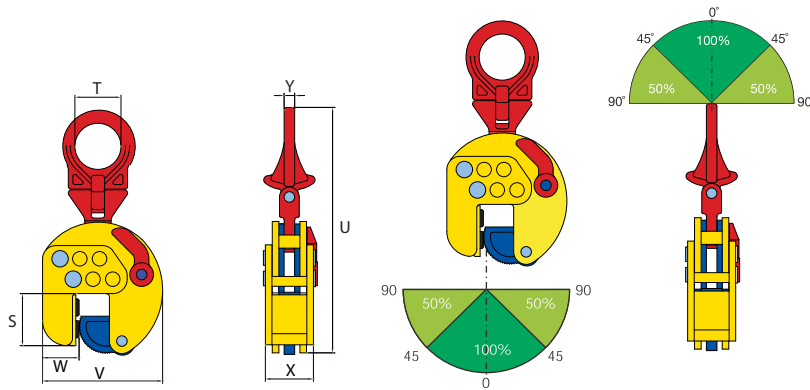

Ref. nr.	Type	Capacity(kg)	Jawopening (R) (mm)	Dimensions in mm							Weight(kg)
				S	T	U	V	W	X	Y	
54A100300A	3 TSEU-A	3000	0-95	80	70	385	235-300	55	42	15	11

TSU-R

- For lifting and transporting of stainless steel plates and structures a TSU-R lifting clamp is available.
- Pivot and cam are made of stainless steel.
- Body and lock lever are nickel plated to prevent corrosion due to carbon contamination.

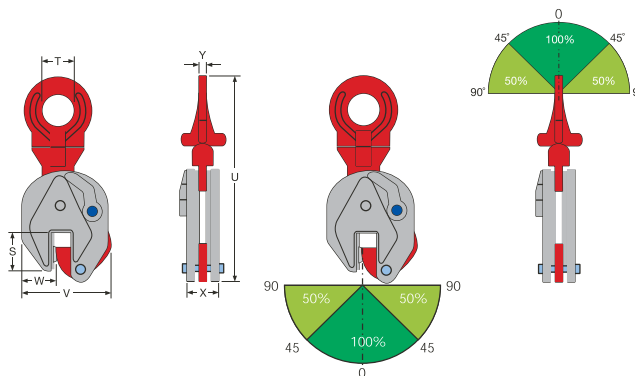

Ref. nr.	Type	Capacity(kg)	Jawopening (R) (mm)	Dimensions in mm							Weight(kg)
				S	T	U	V	W	X	Y	
54A080200A	2 TSU-R	2000	0 - 20	80	70	365	165	55	45	18	7,2

TSHP and TSHPU

TSHP

- For lifting and transporting of Holland-Profile (HP) and structures with HP-profile.
- Also useful as a “big-jaw” opening clamp.
- Standard with 3 pivots for extra powerful clamping force.
- The Terrier TSHP lifting clamps are equipped with a safety mechanism, ensuring the clamp does not slip when lifting force is applied and when load is being lowered.
- The clamp is locked in closed as well as in open position.

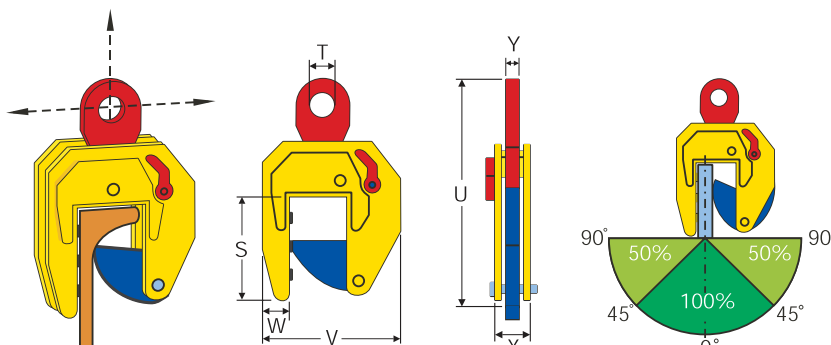

Ref. nr.	Type	Capacity(kg)	Jawopening (R) (mm)	3Dimensions in mm							Weight(kg)
				S	T	U	V	W	X	Y	
54A110100A	1 TSHP	1000	0 - 80	205	65	530	272	55	52	16	19,5
54A110150A	1.5 TSHP	1500	0 - 80	205	65	530	272	55	52	16	20
54A130150A	1.5 TSHP-A	1500	0 - 155	205	65	530	272 - 340	55	52	16	22,5

TSHPU

TSHPU is a follow-up of the TSHP-1 and TSHP-1.5. It is especially designed for lifting, handling and transporting of HP-profile and construction with HP-profile.

Properties

- capacity 3.0 tons. Opening 0 - 35 mm.
- capacity 5.0 tons. Opening 0 - 45 mm.

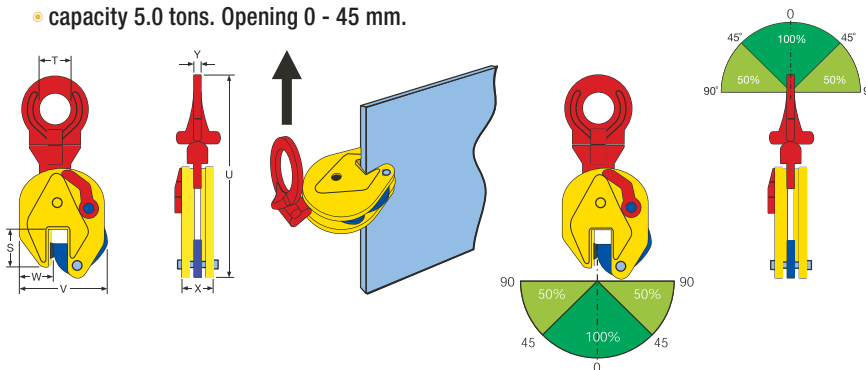

Ref. nr.	Type	Capacity(kg)	Jawopening (R) (mm)	Dimensions in mm							Weight(kg)
				S	T	U	V	W	X	Y	
54A120300A	3 TSHPU	3000	0 - 35	90	70	385	185	55	42	15	15
54A120500A	5 TSHPU	5000	0 - 45	110	68	425	245	84	67	25	19

TNMK / TNMKA

TNMK

- TNMK is a NON-MARKING clamp with 2 special synthetic pads. The clamp can be used for lifting, handling and transporting (stainless) steel, aluminium, wood and marble plates.
- After lifting and handling, the clamps leave no markings.
- The clamp is locked in closed as well as in open position.

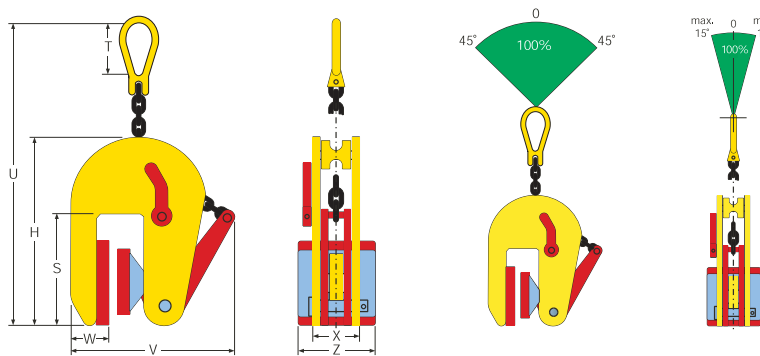

TNMKA

A min. 3 mm/max. 180 mm
V min. 220 mm/max. 400 mm

Adjustable in steps of 20 mm.

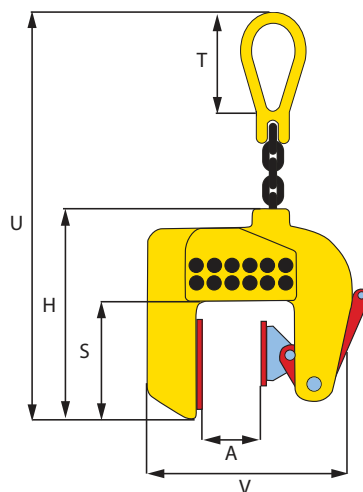

Ref. nr.	Type	Capacity(kg)	Jaw-opening (A) (mm)	Dimensions in mm							Weight(kg)
				H	S	T	U	V	X	Z	
54A140050A	0.5 TNMK	500	1 - 20	200	93	65	360	220	48	80	5,5
54A150050A	0.5 STNMK	500	17 - 37	200	93	65	360	240	48	80	5,5
54A160050A	0.5 TNMKA	500	1 - 180	223	143	65	360	220-400	66	80	10
54A140100A	1 TNMK	1000	1 - 30	235	95	80	400	275	54	80	6,5
54A140150A	1.5 TNMK	1500	1 - 40	235	95	80	400	275	54	80	7,2
54A140200A	2 TNMK	2000	1 - 50	360	120	100	660	380	65	80	14
54A140300A	3 TNMK	3000	1 - 60	360	120	100	660	380	65	80	15

FBK and TOBK

- For lifting and transportation of steel beams, profiles and structures where the load must stay in position.
- The special shape of the lifting shackle, places the centre of the gravity of the beam to be lifted directly beneath the lifting shackle.
- This maintains the equilibrium of the beam once it has been lifted and keeps the flanges of the vertical so that the beam can easily be stacked or positioned.
- Especially recommended for transportation and stacking of steelbeams (e.g. when sawing of steelbeams, stacking of steelbeams and building of steel constructions).
- Lifting capacity and jaw-opening are clearly engraved in the body.

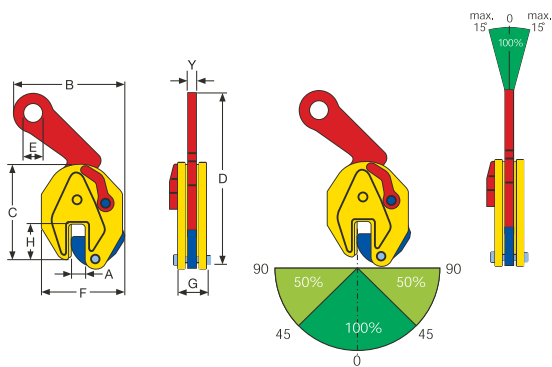

- For lifting and transportation of steel beams, profiles and structures.
- Because of the safety mechanism, the clamp is locked in closed as well as in open position.
- The clamp is suitable to lift steel beams on the flange as well as on the rear ends of the beam.
- Other capacity and jaw-opening on request.

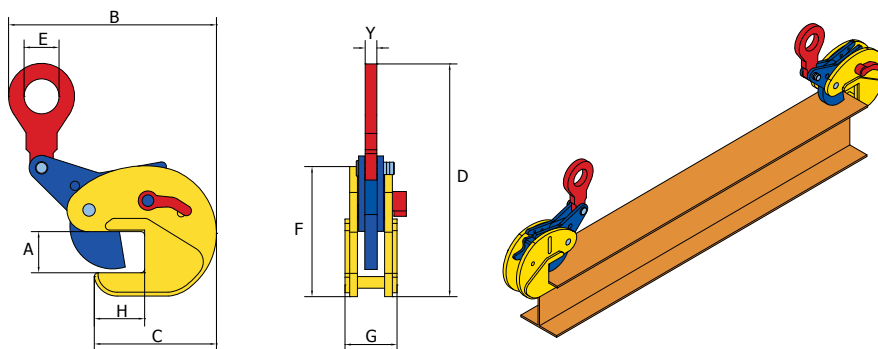

Ref. nr.	Type	Capacity (kg/pair)	Jaw-opening (R) (mm)	Dimensions in mm								Weight (kg/pc)
				B	C	D	E	F	G	H	Y	
54A170100A	1 FBK	1000	0 - 15	200	120	250	21,5	130	35	45	15	3
54A170150A	1.5 FBK	1500	0 - 20	260	200	350	65	170	45	65	15	8
54A170300A	3 FBK	3000	0 - 25	380	200	410	72	205	67	65	30	16
54A180150A	2 TOBK	2000	3 - 20	280	157	325	64	168	67	65	17	9,5

TJP and TCK

TCK

- For vertical lifting and transporting of structures where a square tube is used as a frame. For example mobile units etc.
- If the clamp is being loaded, the cams will pull out sideways and will grip into the sides of the square tube.
- Because of the compact design of the clamp, the clamp will not use more space than the dimensions of the square tube.
- The clamp is equipped with an universal lifting eye.
- Lifting capacity and jaw opening are clearly engraved in the body.

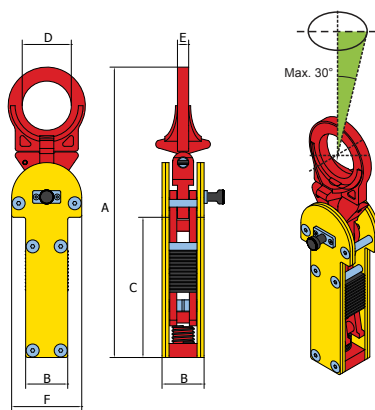

Ref. nr.	Type	Capacity (kg)	Jaw-opening	A	B	C	D	E	F	Weight (kg)
810000	3 TCK	3000	62 - 70	414	60	200	70	16	100	7

TJP

- For vertical lifting and transporting of (thin) sheet metal.
- The TJP clamp is equipped with a special pivot, the special pivot will adapt itself to the load of the clamp. This will generate more friction which eliminates the chance of slipping loads. Lifting force is applied and when load is being lowered.
- The clamp is locked in closed as well as in open position.
- Lifting capacity and jaw opening are clearly engraved in the body.

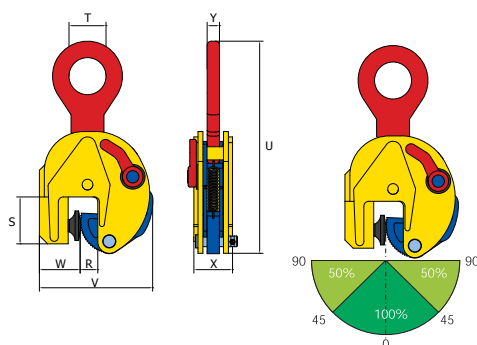

Ref. nr.	Type	Capacity (kg)	Jaw-opening	S	T	U	V	W	X	Y	Weight (kg)
870800	1 TJP	1000	0 - 20	57	45	258	138	50	47	15	4

FHX / FHSX

- For horizontal lifting and transporting of steel plates.
- The compact shape and relative light own weight with a high lifting capacity.
- The Terrier FHX/FHSX lifting clamps must always be used in pairs (or multiples thereof).
- Lifting capacity and jaw opening are clearly engraved in the body.
- The FHS has an enlarged jaw opening.

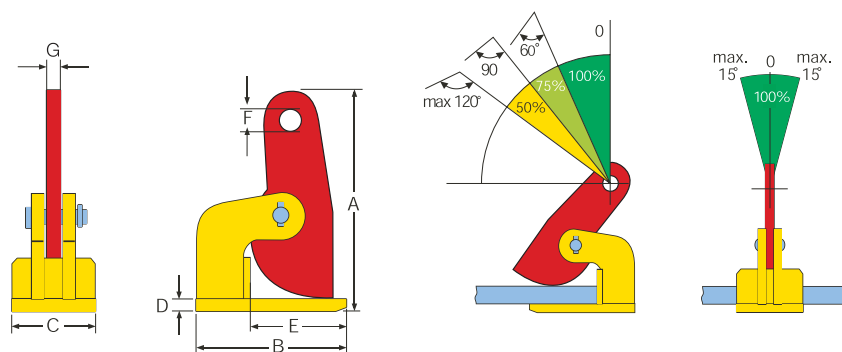
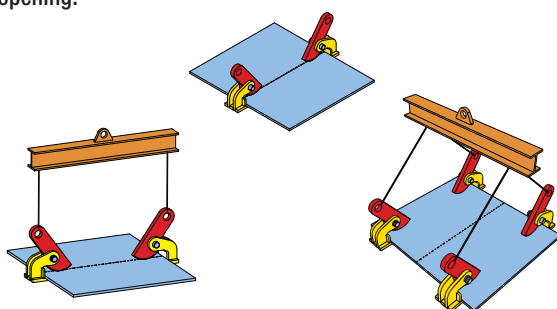

Ref. nr.	Type	Capacity(kg)	Jawopening (R) (mm)	Dimensions in mm							Weight(kg)
				A	B	C	D	E	F	G	
54B010100A	1 FHX	1000	0 - 35	193	140	68	10	100	25	15	2,6
54B010200A	2 FHX	2000	0 - 60	290	180	80	20	115	30,5	15	7,7
54B010300A	3 FHX	3000	0 - 60	293	220	90	20	140	30,5	20	11,4
54B010400A	4 FHX	4000	0 - 60	295	220	100	25	135	30,5	30	13
54B010600A	6 FHX	6000	0 - 60	330	225	120	30	130	30,5	30	13
54B010800A	8 FHX	8000	0 - 60	330	225	120	30	130	30,5	30	18
54B010800A	10 FHX	10000	0 - 60	330	225	120	30	130	30,4	30	20
54B011200A	12 FHX	12000	0 - 60	330	225	120	30	130	30,5	30	21
54B020200A	2 FHSX	2000	0 -100	380	180	80	20	115	30,5	15	9
54B020300A	3 FHSX	3000	0 -100	400	220	90	20	140	30,5	15	14
54B020400A	4 FHSX	4000	0 -100	410	220	100	25	135	30,5	20	16
54B020600A	6 FHSX	6000	0 -100	425	225	120	30	130	30,5	30	22
54B020800A	8 FHSX	8000	0 -100	425	225	120	30	130	30,5	30	22
54B021000A	10 FHSX	10000	0 -100	425	225	120	30	130	30,5	30	22
54B021200A	12 FHSX	12000	0 -100	425	225	120	30	130	30,4	30	22
54B021500A	15 FHSX	15000	0 -150	665	350	140	30	240	45	30	50

TDH

- For lifting and transporting of thin sheets that deflect when being lifted.
- Compact shape and relatively low own weights, with a high lifting capacity.
- The Terrier TDH horizontal lifting clamps must always be used in pairs (or multiples thereof).

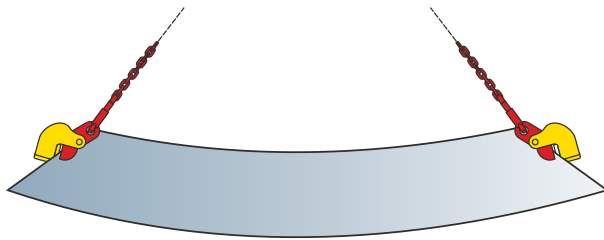
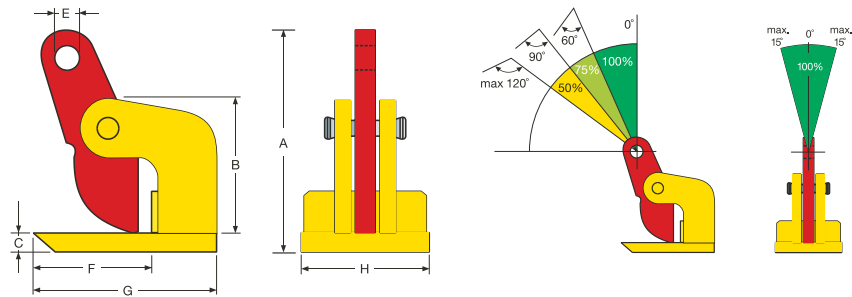

Ref. nr.	Type	Capacity (kg/pair)	Jaw-opening (R) (mm)	Dimensions in mm							Weight (kg/pc)
				A	B	C	D	E	F	G	
54.B.05.0100.A	1 TDH	1000	0 - 15	167	85	10	22,5	100	140	65	3
54.B.05.0200.A	2 TDH	2000	0 - 35	235	135	20	26	115	180	80	8
54.B.05.0400.A	4 TDH	4000	0 - 50	310	157	35	40	130	235	130	20
54.B.05.0600.A	6 TDH	6000	0 - 50	310	157	35	40	130	235	130	20

THSK

- For lifting, handling and transporting of packages and single steel plates
- The Terrier THSK horizontal lifting clamps must always be used in pairs (or multiples thereof).
- Capacity 1.5 tons per pair upto 9 tons per pair.
- Opening 3 - 180 mm, 3 - 300 mm and 3 - 420 mm.

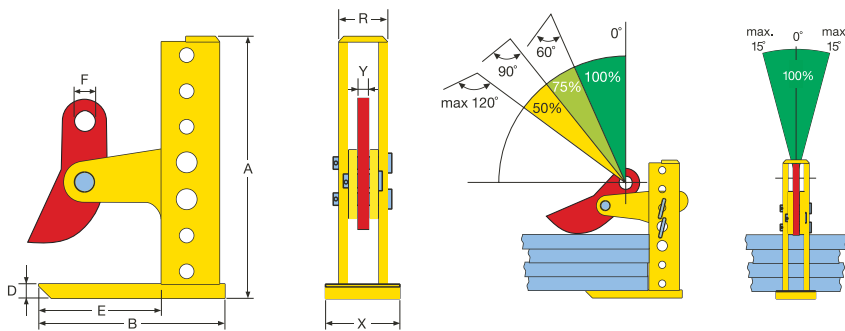

Ref. nr.	Type	Capacity (kg/pair)	Jawopening (R) (mm)	Dimensions in mm								Weight (kg/pc)
				A	B	D	E	F	R	X	Y	
54B060150A	1,5 THSK	1500	3 - 180	290	200	15	135	27	60	87	20	9
54B060150B	1,5 THSK-W	1500	3 - 300	410	200	15	135	27	60	87	20	11,5
54B060300A	3 THSK	3000	3 - 180	300	240	20	165	27	70	105	20	14,5
54B060300B	3 THSK-W	3000	3 - 300	410	235	20	165	27	70	105	20	13
54B060450A	4,5 THSK	4500	3 - 180	300	240	20	165	27	70	105	20	13
54B060450B	4,5 THSK-W	4500	3 - 420	530	235	20	170	27	70	105	20	15
54B060600A	6 THSK	6000	3 - 180	305	250	25	160	27	77	120	20	20
54B060600B	6 THSK-W	6000	3 - 420	540	250	25	165	27	75	120	20	23
54B060900A	9 THSK	9000	3 - 180	305	250	25	160	27	77	120	20	25,5
54B060900B	9 THSK-W	9000	3 - 420	540	250	25	165	27	75	120	20	29,5

FHX-V and TNMH

- The FHX-V lifting clamp has a spring attached to the cam assembly. The spring makes sure that the clamp will be closed on any desired spot.
- One of the major advantages of this clamp is that only one person is able to place the clamps and to guide the hoist.
- These clamps are available with a capacity from 1000 kg per pair till 3000 kg per pair.

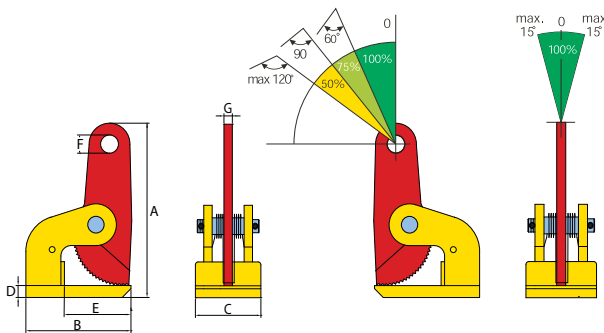

Ref. nr.	Type	Capacity (kg/pair)	Jaw-opening (R) (mm)	Dimensions in mm							Weight (kg/pc)
				A	B	C	D	E	F	G	
54.B.03.0100.A	1 FHX-V	1000	0 - 35	193	140	85	10	100	25	15	3
54.B.03.0100.A	2 FHX-V	2000	0 - 60	290	180	125	15	115	30,5	16	9
54.B.03.0300.A	3 FHX-V	3000	0 - 60	293	180	125	20	115	30,5	16	10
54.B.03.0400.A	4 FHX-V	4000	0 - 60	310	220	165	30	140	30,5	20	15
54.B.03.0600.A	6 FHX-V	6000	0 - 60	310	220	165	30	140	30,5	20	15

- The TNMH lifting clamp is suited for transporting and lifting objects with a fragile surface. Like stainless steel, wood panels, aluminium etc.
- The jaw and cam is covered with a high quality pressure resistant fabric.
- These clamps are available with a capacity from 1000 kg per pair till 6000 kg per pair.

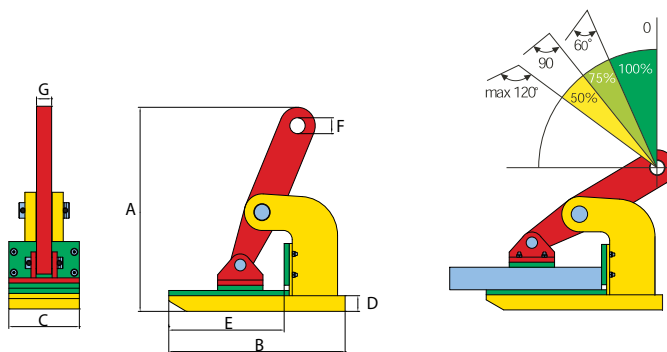

Ref. nr.	Type	Capacity (kg/pair)	Jaw-opening (R) (mm)	Dimensions in mm							Weight (kg/pc)
				A	B	C	D	E	F	G	
54B040100A	1 TNMH	1000	0 - 25	154	140	65	15	95	20	15	3
54B040200A	2 TNMH	2000	0 - 45	270	225	90	23	150	30,5	15	8
54B040300A	3 TNMH	3000	0 - 45	275	225	90	28	160	30,5	15	16
54B040400A	4 TNMH	4000	0 - 50	305	250	105	28	160	30,5	20	9,5
54B040600A	6 TNMH	6000	0 - 50	310	250	120	33	160	30,5	20	17

TPH

- For horizontal lifting and transporting of steel and concrete pipes.
- Compact shape and relatively low own weight with a high lifting capacity.
- The surface is equipped with “special” plastic.
- The Terrier TPH will be delivered per pair.
- Plastic cover is easy to change.
- TPH can be delivered with Berglock-coupling BL.

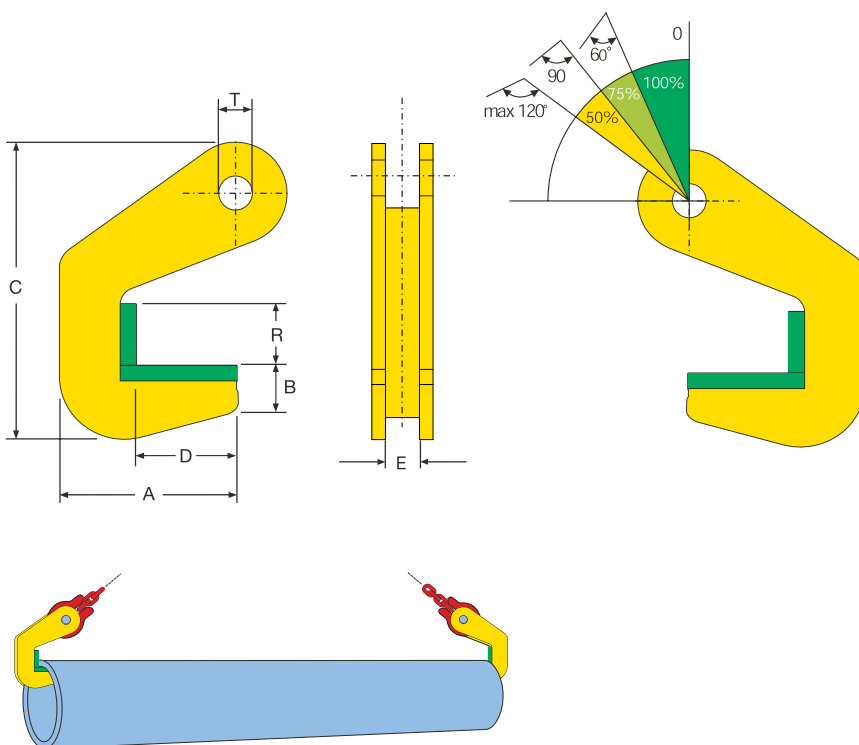

Ref. nr.	Type	Capacity (kg/pair)	Jawopening (R) (mm)	Dimensions in mm						Weight (kg/pc)
				A	B	C	D	E	T	
54B070150A	1.5 TPH	1500	40	120	32	175	70	25	15	1,6
54B070300A	3 TPH	3000	40	120	32	175	70	25	15	1,6
54B070400A	4 TPH	4000	50	120	32	195	70	25	25	2
54B070600A	6 TPH	6000	50	120	32	195	70	25	25	3,3
54B070800A	8 TPH	8000	70	120	32	195	70	25	26	3,6
54B071000A	10 TPH	10000	70	120	32	215	70	45	26	5
54B071200A	12 TPH	12000	70	120	32	215	70	45	26	6
54B071500A	15 TPH	15000	70	120	32	215	70	60	26	10
54B072000A	20 TPH	20000	70	120	32	215	70	60	26	16

FSV / FSVW

- For horizontal lifting and transporting of steel beams and structures.
- Can also be attached upside down and be used as a (temporary) lifting point.
- Has equal opening and closing of both jaws for simple and quick assembly.
- Lifting capacity and jaw opening are clearly engraved in the body.
- Type FSVW is identical to type FSV but is delivered without a lifting eye so you can choose your own means of fixation.

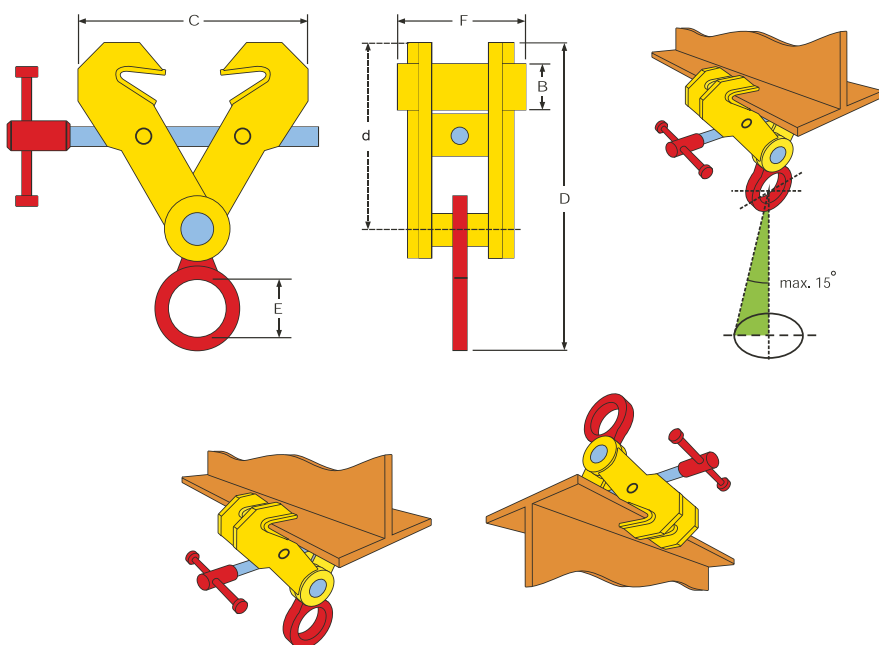

Ref. nr.	Type	Capacity (kg/pcs)	Jaw-opening (R) (mm)	Dimensions in mm					Weight(kg)
				B	C-max	D-Max	E	F	
54C010100A	1 FSV	1000	75 - 190	30	285	310	73	120	4
54C010200A	2 FSV	2000	75 - 190	30	285	310	73	120	5
54C010300A	3 FSV	3000	75 - 190	30	285	310	73	120	5
54C010400A	4 FSV	4000	150 - 300	50	460	430	79	180	13
54C010500A	5 FSV	5000	150 - 300	50	460	430	79	180	14
54C011000A	10 FSV	10000	350 - 450	130	670	670	85	200	35

Ref. nr.	Type	Capacity (kg/pcs)	Jaw-opening (R) (mm)	Dimensions in mm					Weight(kg)
				B	C-max	D-Max	E	F	
54C020100A	1 FSVW	1000	75 - 190	30	285	150	73	120	3
54C020200A	2 FSVW	2000	75 - 190	30	285	150	73	120	4
54C020300A	3 FSVW	3000	75 - 190	30	285	150	73	120	4
54C020400A	4 FSVW	4000	150 - 300	30	460	245	79	180	12
54C020500A	5 FSVW	5000	150 - 300	30	460	245	79	180	12

TSCC

- Universal screw clamp for vertical and horizontal lifting and transporting of a large variety of steel structures.
- The TSCC screw clamp is fitted with a moveable cam on the thread spindle which provides a powerful clamping force on the workpiece.
- The articulated lifting eye ensures an effective clamping force in every position.

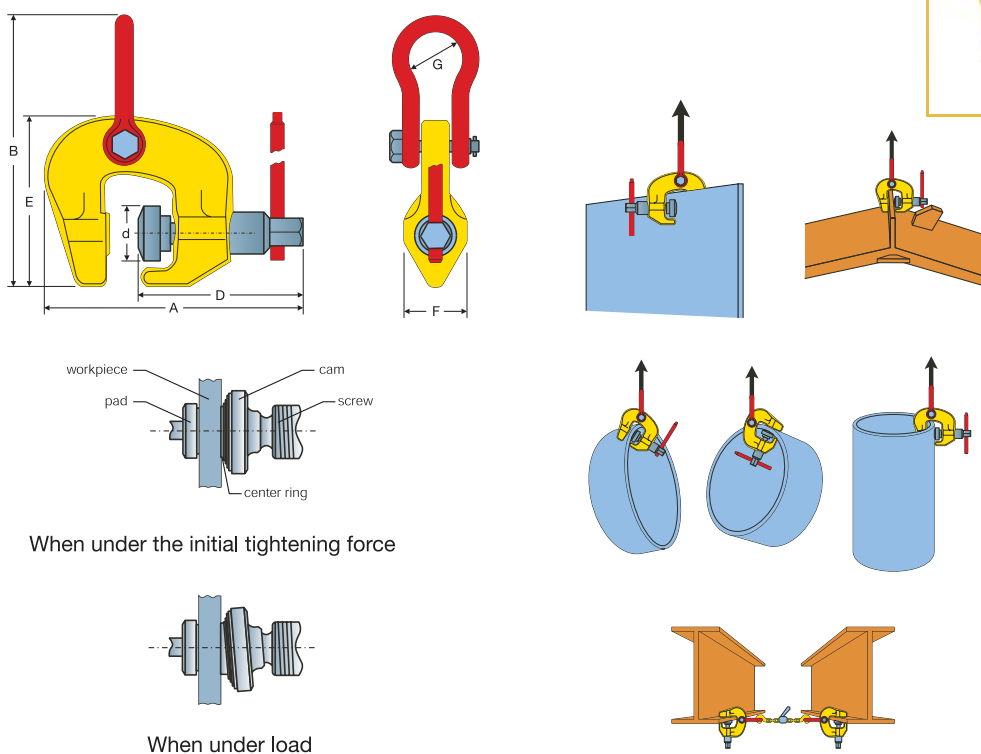

Ref. nr.	Type	Capacity(kg)	Jawopening (R) (mm)	Dimensions in mm							Weight(kg)
				A	B	C	D	E	F	G	
54.C.03.005.OA	0.5 TSCC	500	0 - 28	156	113	89	26	76	30	17	0,8
54.C.03.0075.A	0.75 TSCC*	750	0 - 22	167	201	120	42	125	46	38	3
54.C.03.0100.A	1 TSCC	1000	0 - 30	175	204	126	42	128	46	38	3,2
54.C.03.0150.A	1.5 TSCC	1500	0 - 32	187	229	135	42	143	46	45	4
54.C.03.0300.A	3 TSCC	3000	0 - 50	224	265	165	49	165	54	50	7
54.C.03.0600.A	6 TSCC	6000	0 - 75	291	365	215	63	214	69	80	18
54.C.03.0100.B	1 TSCC-W	1000	50 - 100	258	273	155	42	190	46	45	3,2
54.C.03.0300.B	3 TSCC-W	3000	25 - 75	250	291	165	49	191	54	50	7,8

*is running out

TBS

- For use as a temporary lifting point in any room where HP-profile is being used, such as sectional ship parts and ship engine rooms.
- The clamp is used for HP-100 to HP-240.

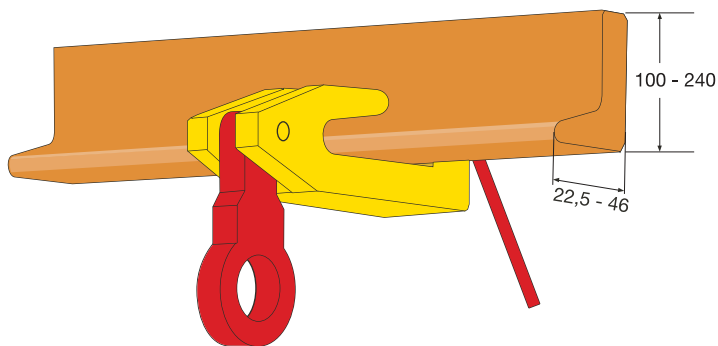
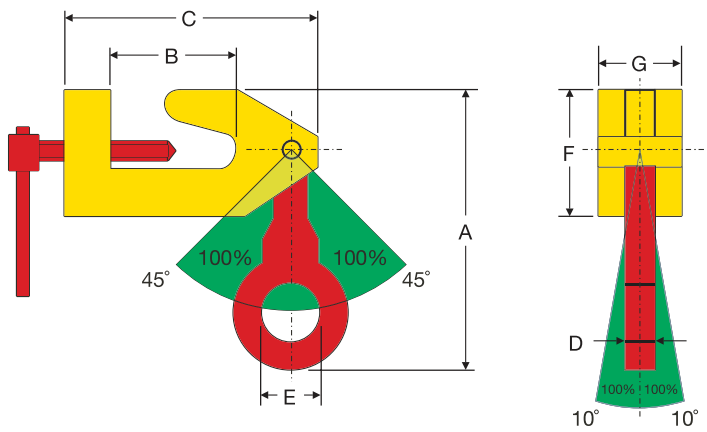

Ref. nr.	Type	Capacity(kg)	Jaw-opening (R) (mm)	Dimensions in mm							Weight(kg)
				A	B	C	D	E	F	G	
54C040150A	1.5 TBS	1500	HP100 - 240	170	70	149	16	44	70	40	3
54C040300A	3 TBS	3000	HP100 - 240	200	70	149	16	44	70	80	6,5

TBC and TBCA

TBC

- For vertical lifting and transporting of concrete pipe and wells.
- The TBC clamps must always be used in pairs or per three clamps.
- Higher capacities or other jaw opening upon request.
- The moveable side is fitted with a "special" high pressure plastic surface.

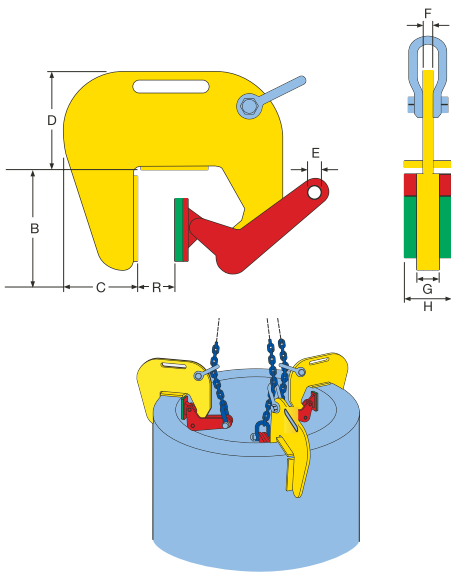

TBCA

R min. 60 mm/max. 220 mm.
Adjustable in steps of 25 mm.

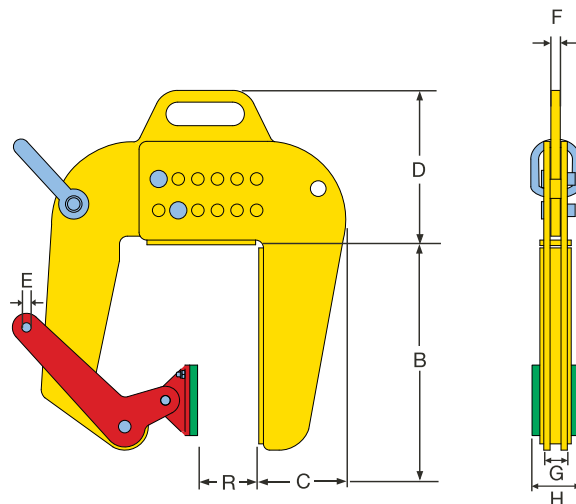

Ref. nr.	Type	Capacity(kg)	Jaw-opening (R) (mm)	Dimensions in mm							Weight (kg/pc)
				B	C	D	E	F	G	H	
54E020050A	0.5 TBC	500	60-120	170	110	160	12	12	25	60	10
54E020050A	1 TBC	1000	60-120	170	110	160	12	12	25	60	10
54E030100A	1 TBCT	1000	60-120	235	60	75	16	12	35	35	8,5
54E040100A	1 TBC-A	1000	50-230	170	110	160	12	12	25	60	11

TVK and TVKH

TVK

- For safe lifting and transporting of steel (oil) drums.
- With automatic locking mechanism.
- The TVK steel drum clamps are supplied with an original certificate.
- The TVK steel drum clamps can be used singly or per pair as well.

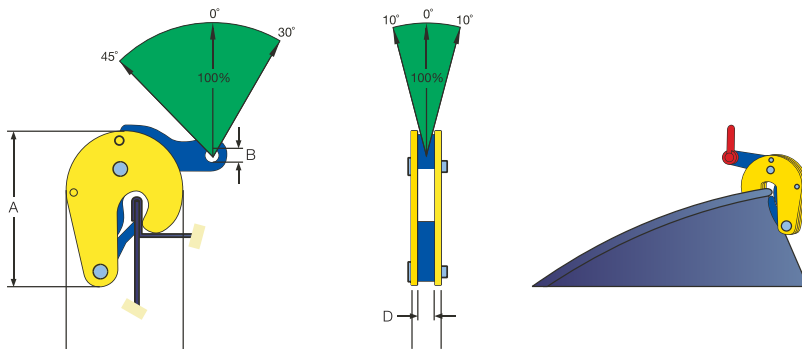

Ref. nr.	Type	Capacity(kg)	Jawopening (R) (mm)	Dimensions in mm					Weight(kg)
				A	B	C	D	E	
54D010050A	TVK	500	0 - 17	129	12	96	15	28	1,6

TVKH

- For lifting, handling and transporting of (oil)drums, where the drums have to stay in a horizontal position.
- Capacity 0.6 tons.

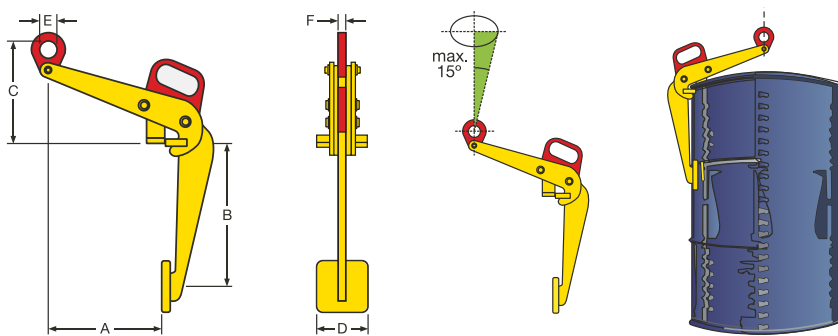

Ref. nr.	Type	Capacity(kg)	Dimensions in mm						Weight(kg)
			A	B	C	D	E	F	
54D020060A	TVKH	600	300	375	290	80	50	12	7

VERTICAL CLAMPS WITH AN EXTRA HARDENED PIVOT AND CAM

- Equipped with an extra hardened pivot and cam for lifting and transporting steel plates with a hardness of max. 50 HRC. (for Hardox 400 and 500)
- Can be delivered as TS, TSMP and TSU model.
- Please ask for special specifications.
- For dimensions and loading diagrams see page 5, page 6 and page 7.
- Other capacity and jaw-opening on request.



Ref. nr.	Type	Capacity(kg)	Jaw-opening (R) (mm)	Dimensions in mm							Weight(kg)
				S	T	U	V	W	X	Y	
54A010075H	0.75 TS-H	750	0 - 13	47	30	205	100	37	37	10	1,3
54A020100H	1 TSE-H	1000	0 - 25	55	44	240	142	35	35	15	3,6
54A020100H	2 TSE-H	2000	0 - 35	78	65	350	185	43	46	17	6,5
54A020300H	3 TSE-H	3000	0 - 35	78	65	350	185	54	54	17	6,7
54A020450H	4.5 TSE-H	4500	0 - 45	85	68	430	245	67	67	22	15,9
54A010600H	6 TS-H	6000	0 - 32	114	75	490	255	69	69	25	18,6
54A020750H	7.5 TSE-H	75000	0 - 55	112	75	540	245	70	70	25	24
54A040075H	0.75 TSMP-H	750	0 - 13	47	30	260	100	25	37	10	2
54A050100H	1 TSEMP-H	1000	0 - 25	55	45	425	142	38	35	15	4,5
54A050200H	2 TSMP-H	2000	0 - 35	80	65	510	180	58	43	17	7,7
54A050300H	3 TSEMP-H	3000	0 - 35	80	65	515	185	55	42	15	5
54A050450H	4.5 TSEMP-H	4500	0 - 45	85	68	705	245	64	67	22	19,2
54A040600H	6 TSMP-H	6000	0 - 32	114	74	760	240	71	69	25	22,8
54A050750H	7.5 TSEMP-H	7500	0 - 55	112	75	820	245	58	70	25	28
54A070075H	0.75 TSU-H	750	0 - 13	47	30	210	100	25	37	10	1,7
54A080100H	1 TSEU-H	1000	0 - 25	55	48	285	142	38	35	18	3,9
54A080200H	2 TSEU-H	2000	0 - 35	80	70	380	180	58	43	18	7,3
54A080300H	3 TSEU-H	3000	0 - 35	80	70	385	185	55	42	15	7,5
54A080450H	4.5 TSEU-H	4500	0 - 45	85	68	425	245	64	67	25	16,7
54A070600H	6 TSU-H	6000	0 - 32	115	80	520	245	64	69	32	21
54A080750H	7.5 TSEU-H	7500	0 - 55	112	80	560	245	58	70	32	26

STELCON PLATEHOOKS and TRC

STELCON PLATEHOOKS

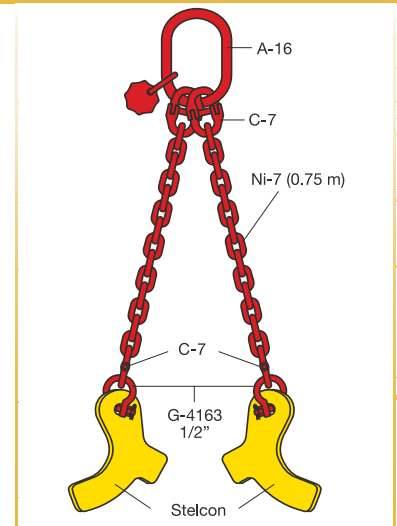

- For vertical transport of rail profiles.
- The TRC is equipped with a safety mechanism, ensuring the clamp does not slip when lifting force is applied and when load is being lowered.
- The clamp is locked in closed as well in open position.
- Other capacities or other profile dimensions on request.

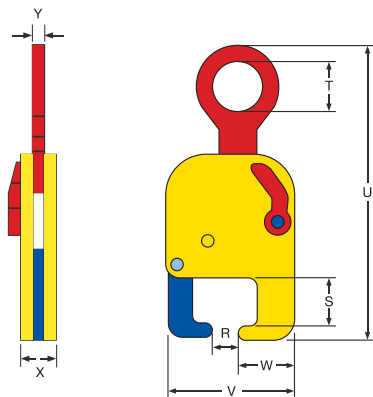

Ref. nr.	Type	Capacity(kg)	Jawopening (R) (mm)	Dimensions in mm							Weight(kg)
				B	C	D	E	F	G	H	
54E050150A	TRC	1500	40 - 75	63	65	390	170	70	48	16	8

TTL / TBLC

TTL

For vertical lifting of tubes, bundles of tubes and solid round material.

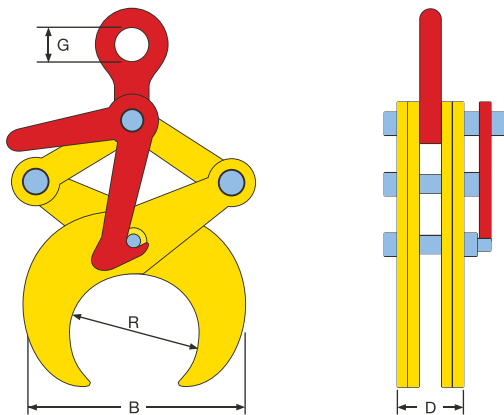

Ref. nr.	Type	Capacity(kg)	Jaw-opening (R) (mm)	Dimensions in mm			Weight(kg)
				B max	D	G	
54E060050A	0.5 TTL	500	48,3 - 114,3	215	47	42	5
54E060100A	1 TTL	1000	114,3 - 219,1	345	51	42	9
54E060200A	2 TTL	2000	219,1 - 368	610	60	65	31
54E060300A	3 TTL	3000	368 - 508	720	60	65	40

TBLC

- For vertical lifting and transporting without marking of products with parallel sides in various materials as steel, wood, plastic, concrete, marble etc.
- The clamp is locked in the open position. To perform lifting, the operator must activate the handle and hold it up while the force on the lifting eye is going upwards. When laying down the load, the clamp automatically locks itself open.
- De pads are covered with special plastic to avoid dammaging of the load.

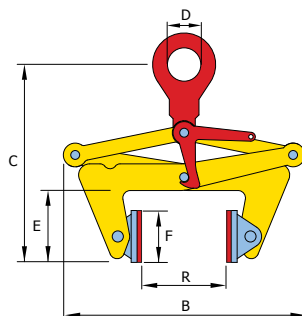

Ref. nr.	Type	Capacity(kg)	Jaw-opening (A) (mm)	Dimensions in mm						Weight(kg)
				B min-max	C min-max	D	E min-max	F	G	
54.E.07.0050.A	0,5 TBLC	500	30-110	275-325	270-420	45	100	70*80	15	7
54.E.07.0100.A	1 TBLC	1000	100-230	440-530	360-610	45	140	100*120	17	12
54.E.07.0200.A	2 TBLC	2000	220-360	600-675	400-680	45	170	100*120	17	18
54.E.07.0300.A	3 TLC	3000	350-500	740-840	490-840	65	200	100*120	20	32

SPARE PARTS

All spare parts are available either separately or as repair sets. It is recommended when any parts are damaged to replace them straight away and not to take any risk.

When ordering spare parts always give: model, lifting capacity, jaw opening and serial number as well as the needed spare parts.

- A Cam assembly
- B Lock lever assembly
- C Lock spring
- D Cam pin
- E Pivot complete
- F Shackle pin
- G Lifting eye for TS, STS, MP model
- H Lifting eye for TSU, STEU model
- I Linkage arr. STMP, STSMP model
- J Link pin for MP model
- L Cam for FHX model
- M Cam pin for FHX model
- N Cam for FHSX model
- O Cam pin for FHSX model

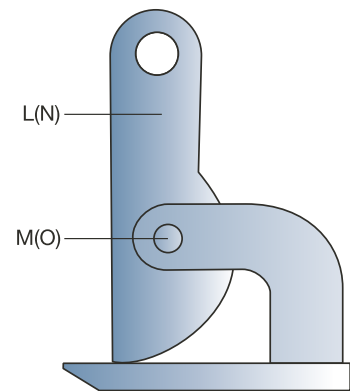
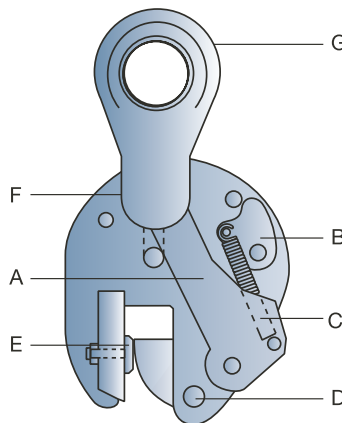

For every vertical clamps are revision- sets and repairsets available.

The repair sets contain :

- A Cam assembly
- C Lock spring
- D Cam pin
- E Pivot set

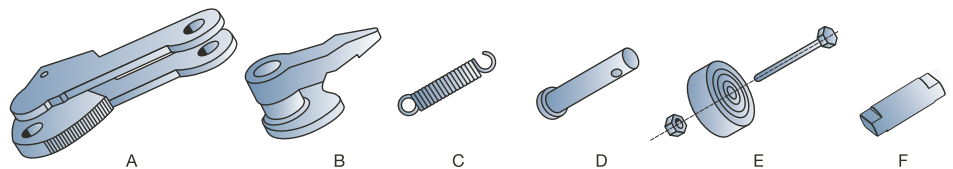

The revision sets contain :

- A Cam assembly
- B Lock lever assembly
- C Lock spring
- D Cam pin
- E Pivot complete

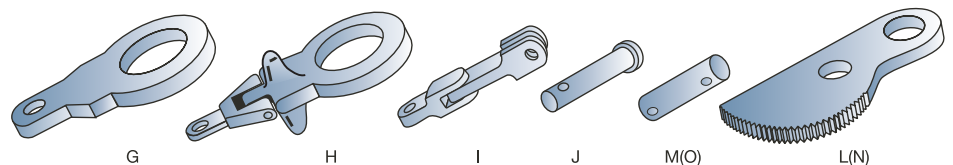

Spareparts - TS / STS

All spare parts are available either separately or as repair sets. It is recommended when any parts are damaged to replace them straight away and not to take any risk.

When ordering spare parts always give: model, lifting capacity, jaw opening and serial number as well as the needed spare parts

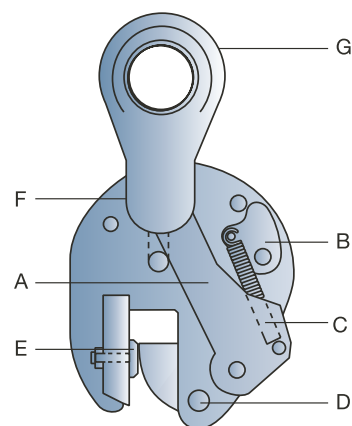

Type	A	B	C	D	E	F	G
	Cam assy	Lock leverassy	Spring	Campin	Pivot	Shackle pin	Lifting shackle
0.75 TS	55.550020	55.550031	55.250000	55.550029	55.550019	55.550058	55.550050
1 TS	55.550820	55.550831	55.250800	55.550829	55.550819	55.550858	55.550850
1 TSE	55.550880	55.550831	55.250800	55.550829	55.550819	55.550858	55.550850
1.5 TS	55.550120	55.550131	55.250100	55.550129	55.550119	55.550158	55.550150
2 TSE	55.550920	55.550131	55.250100	55.550129	55.550119	55.550158	55.550150
3 TSE	55.550920	55.550131	55.250100	55.552929	55.550119	55.550158	55.550150
4.5 TS	55.550220	55.550231	55.250200	55.550329	55.550219	55.550258	55.550250
4.5 TSE	55.552220	55.552431	55.250200	55.550329	55.550219	55.550258	55.550250
6 TS	55.550320	55.550331	55.250300	55.550329	55.550219	55.550358	55.550350
7.5 TS	55.550420	55.550431	55.250400	55.550429	55.550219	55.550458	55.550450
7.5 TSE	55.552620	55.550431	55.250400	55.550429	55.550219	55.550458	55.550450
9 TS	55.552620	55.550531	55.250400	55.551029	55.550219	55.550458	55.550450
12 TS	55.550520	55.550531	55.250400	55.550529	55.550219	55.550558	55.550550
15 TS	55.550620	55.550631	55.250600	55.550629	55.550619	55.550658	55.550650
17 TS	55.550620	55.550631	55.250600	55.550629	55.550619	55.550658	55.550650
20 TS	55.550720	55.550731	55.250700	55.550729	55.550719	55.550758	55.550750
25 TS	55.550720	55.550731	55.250700	55.550729	55.550719	55.550758	55.550750
30 TS	55.550720	55.550731	55.250700	55.550929	55.550719	55.550758	55.550750

Spareparts - TSMP / STSMP

All spare parts are available either separately or as repair sets. It is recommended when any parts are damaged to replace them straight away and not to take any risk.

When ordering spare parts always give: model, lifting capacity, jaw opening and serial number as well as the needed spare parts.

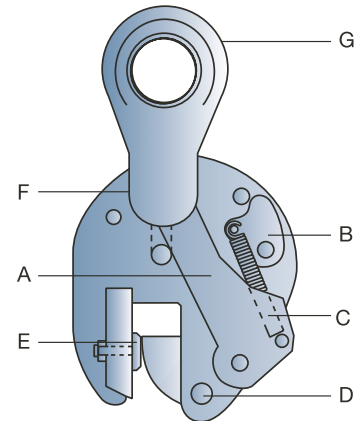

Type	A	B	C	D	E	F	G	I	J
	Cam assy	Lock leverassy	Spring	Campin	Pivot	Shackle pin	Lifting shackle	Link arr.	Link pin
0.75 TSMP	55.250000	55.550029	55.550019	55.550058	55.550050	55.550060	55.550059	55.550060	55.550059
1 TSMP	55.250800	55.550829	55.550819	55.550858	55.550850	55.550860	55.570128	55.550860	55.570128
1 TSEMP	55.250800	55.550829	55.550819	55.550858	55.550850	55.550860	55.570128	55.550860	55.570128
1.5 TSMP	55.250100	55.550129	55.550119	55.550158	55.550150	55.550160	55.550129	55.550160	55.550158
2 TSEMP	55.250100	55.550129	55.550119	55.550158	55.550150	55.550160	55.550129	55.550160	55.550158
3 TSEMP	55.250100	55.552929	55.550119	55.550158	55.550150	55.550160	55.550129	55.550160	55.550158
4.5 TSMP	55.250200	55.550329	55.550219	55.550258	55.550250	55.550260	55.550259	55.550260	55.550259
4.5 TSEMP	55.250200	55.550329	55.550219	55.550258	55.550250	55.550260	55.550259	55.550260	55.550259
6 TSMP	55.250300	55.550329	55.550219	55.550358	55.550350	55.550360	55.550329	55.550360	55.550329
7.5 TSMP	55.250400	55.550429	55.550219	55.550458	55.550450	55.550460	55.550329	55.550460	55.550329
7.5 TSEMP	55.250400	55.550429	55.550219	55.550458	55.550450	55.550460	55.550329	55.550460	55.550329
9 TSMP	55.250400	55.551029	55.550219	55.550458	55.550450	55.550460	55.550329	55.550460	55.550329
12 TSMP	55.250400	55.550529	55.550219	55.550558	55.550551	55.550560	55.550559	55.550560	55.550559
15 TSMP	55.250600	55.550629	55.550619	55.550658	55.550651	55.550660	55.550659	55.550660	55.550659
17 TSMP	55.250600	55.550629	55.550619	55.550658	55.550651	55.550660	55.550659	55.550660	55.550659
20 TSMP	55.250700	55.550729	55.550719	55.550758	55.550751	55.550760	55.550759	55.550760	55.550759
25 TSMP	55.250700	55.550729	55.550719	55.550758	55.550751	55.550760	55.550759	55.550760	55.550759

Spareparts - TSU / STSU

All spare parts are available either separately or as repair sets. It is recommended when any parts are damaged to replace them straight away and not to take any risk.

When ordering spare parts always give: model, lifting capacity, jaw opening and serial number as well as the needed spare parts

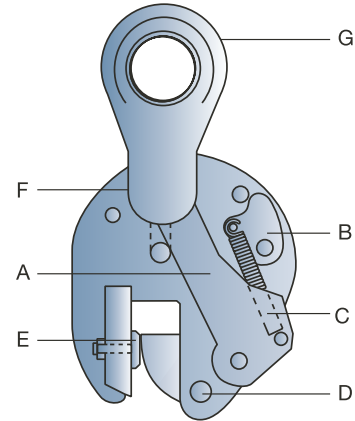

Type	A	B	C	D	E	F	H
	Cam assy	Lock leverassy	Spring	Cam pin	Pivot	Shackle pin	Lifting shackle
0.75 TSU	55.550020	55.550031	55.250000	55.550029	55.550019	55.550058	55.555050
1 TSU	55.550820	55.550831	55.250800	55.550829	55.550819	55.550858	55.555850
1 TSEU	55.550880	55.550831	55.250800	55.550829	55.550819	55.550858	55.555850
1.5 TSU	55.550120	55.550131	55.250100	55.550129	55.550119	55.550158	55.555150
2 TSEU	55.550920	55.550131	55.250100	55.550129	55.550119	55.550158	55.555150
3 TSEU	55.550920	55.550131	55.250100	55.552929	55.550119	55.550158	55.555150
4.5 TSU	55.550220	55.550231	55.250200	55.550329	55.550219	55.550258	55.555250
4.5 TSEU	55.552220	55.552431	55.250200	55.550329	55.550219	55.550258	55.555250
6 TSU	55.550320	55.550331	55.250300	55.550329	55.550219	55.550358	55.555350
7.5 TSU	55.550420	55.550431	55.250400	55.550429	55.550219	55.550458	55.555450
7.5 TSEU	55.552620	55.550431	55.250400	55.550429	55.550219	55.550458	55.555450
9 TSU	55.552620	55.550531	55.250400	55.551029	55.550219	55.550458	55.555450
12 TSU	55.550520	55.550531	55.250400	55.550529	55.550219	55.550558	55.555550
15 TSU	55.550620	55.550631	55.250600	55.550629	55.550619	55.550658	55.555650
17 TSU	55.550620	55.550631	55.250600	55.550629	55.550619	55.550658	55.555650
20 TSU	55.550720	55.550731	55.250700	55.550729	55.550719	55.550758	55.555750
25 TSU	55.550720	55.550731	55.250700	55.550729	55.550719	55.550758	55.555750
30 TSU	55.550720	55.550731	55.250700	55.550929	55.550719	55.550758	55.555950
2 TSU-R	55.562120	55.562131	55.250100	55.562129	55.562119	55.550158	55.555150
3 TSEU-A	55.550920	55.550131	55.250100	55.552929	55.550119	55.550158	55.555150

Spareparts - TSHP(U)

All spare parts are available either separately or as repair sets. It is recommended when any parts are damaged to replace them straight away and not to take any risk.

When ordering spare parts always give: model, lifting capacity, jaw opening and serial number as well as the needed spare parts.

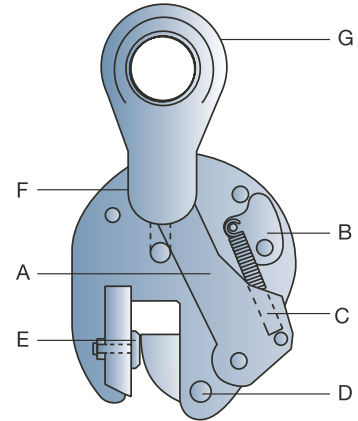

Type	A	B	C	D	E	F	G / H
	Cam assy	Lock leverassy	Spring	Campin	Pivot	Shackle pin	Lifting shackle
1 TSHP	55.560120	55.560131	55.260100	55.555129	55.550119	55.550158	55.560150
1.5 TSHP	55.560120	55.560131	55.260100	55.555129	55.550119	55.550158	55.560150
3 TSHPU	55.550920	55.550131	55.250100	55.555129	55.550119	55.550158	55.555150
5 TSHPU	55.552220	55.552431	55.250200	55.550329	55.550219	55.550258	55.555250

Spareparts - TNMK

Type	Upper -				Under -		
	Push plate	Lock leverassy	Spring	Campin	Push plate	Shackle pin	Lifting shackle
0.5 TNMK	55.562013	55.550831	55.250800	55.555129	55.562014	55.262351	55.262350
1 TNMK	55.562013	55.562433	55.250100	55.552929	55.562014	55.262351	55.262350
1.5 TNMK	55.562013	55.562433	55.250100	55.552929	55.562014	55.262351	55.262350
2 TNMK	55.562013	55.562633	55.250200	55.562618	55.562014	55.290160	55.290159
3 TNMK	55.562013	55.562633	55.250200	55.562618	55.562014	55.290160	55.290159

Spareparts - FBK

Type	A	B	C	D	E	F	G
	Cam assy	Lock leverassy	Spring	Campin	Pivot	Shackle pin	Lifting shackle
1 FBK	55.550820	55.550831	55.250800	55.550829	55.550819	55.551008	55.551015
1.5 FBK	55.550120	55.555131	55.250100	55.555129	55.550119	55.551058	55.551050
3 FBK	55.550220	55.550231	55.250200	55.550329	55.550219	55.551158	55.551150

Spareparts - FH(S)X

All spare parts are available either separately or as repair sets. It is recommended when any parts are damaged to replace them straight away and not to take any risk.

When ordering spare parts always give: model, lifting capacity, jaw opening and serial number as well as the needed spare parts

Type	L	M	Type	N	O
	Cam	Cam pin		Cam	Cam pin
1 FHX	55.5621123	55.561129	2 FHSX	55.561523	55.553029
2 FHX	55.561023	55.553029	3 FHSX	55.561523	55.553029
3 FHX	55.561023	55.553029	4 FHSX	55.561723	55.553229
4 FHX	55.561223	55.553229	6 FHSX	55.561723	55.553229
6 FHX	55.561223	55.553229	8 FHSX	55.561823	55.553429
8 FHX	55.561423	55.553429	10 FHSX	55.561823	55.553429
10 FHX	55.561423	55.553429	12 FHSX	55.561823	55.553429
12 FHX	55.561423	55.223429	15 FHSX	55.520120	55.553629

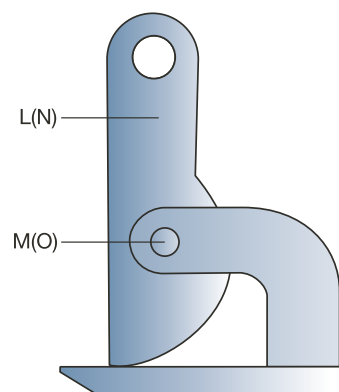

Spareparts - THD

Type	L	M
	Cam	Cam pin
1 TDH	570123	561129
2 TDH	570223	553029

Spareparts - THSK

Type	Cam	Cam pin	Adjustable pin	Connecting - plate
1.5 THSK	55.530159	55.260358	55.260329	55.515160
3 THSK	55.530159	55.260358	55.260329	55.530160
4.5 THSK	55.530159	55.260358	55.260329	55.530160
6 THSK	55.530159	55.260358	55.260629	55.560160
9 THSK	55.530159	55.260358	55.260629	55.560160

Spareparts - FSV(W)

All spare parts are available either separately or as repair sets. It is recommended when any parts are damaged to replace them straight away and not to take any risk.

When ordering spare parts always give: model, lifting capacity, jaw opening and serial number as well as the needed spare parts

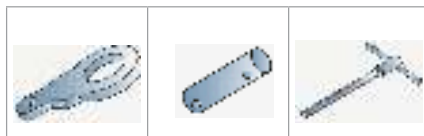

Type	Lifting eye	Shackle pin	Spindel compl.
1 FSV(W)	55.551550	55.551558	55.251530
2 FSV(W)	55.551550	55.551558	55.251530
3 FSV(W)	55.551650	55.551658	55.251530
4 FSV(W)	55.551750	55.551758	55.251730
5 FSV(W)	55.551850	55.551858	55.251730
10 FSV	55.551950	55.551958	55.251930

Spareparts - TBS

Type	Lifting eye	Shackle pin	Spindel compl.
1.5 TBS	55.550850	55.562429	55.562423
3 TBS	55.550150	55.562429	55.562423

Spareparts - TSCC

Type	Lifting eye	Cam	Spindel compl.	Pivot
0.5 TSCC		55.562015	55.562017	55.562016
0.75 TSCC		55.562515	55.562517	55.562516
1.5 TSCC		55.562515	55.562517	55.562516
3 TSCC	55.562.350	55.562315	55.562317	55.562316
6 TSCC		55.562615	55.562617	55.562616

spareparts - TPH

All spare parts are available either separately or as repair sets. It is recommended when any parts are damaged to replace them straight away and not to take any risk.

When ordering spare parts always give: model, lifting capacity, jaw opening and serial number as well as the needed spare parts.

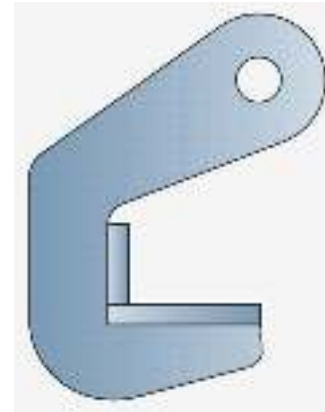

Type	Total width	Plastic coverset	Total width	Plastic coverset
1.5 TPH	37 mm	55.560301		
3 TPH	37 mm	55.560301		
4 TPH	42 mm	55.560401		
6 TPH	42 mm	55.560401		
8 TPH	45 mm	55.560801		
10 TPH	85 mm	55.560810	67 mm	55.560813old
12 TPH	85 mm	55.560810	67 mm	55.560813old
15 TPH	100 mm	55.560820	67 mm	55.560813old
20 TPH	100 mm	55.560820	67 mm	55.560813old

Spareparts - TBC

Type	Hinge pin (small)	Hinge pin (large)	Cam
0.5 TBC	55.570128	55.570129	55.570120
1 TBC	55.570128	55.570129	55.570120

Spareparts - TVK

Type	Hinge pin	Lifting eye	Ratchet
0.5 TVK	55.570128	55.528002	55.528001

spareparts - TBLC

All spare parts are available either separately or as repair sets. It is recommended when any parts are damaged to replace them straight away and not to take any risk.

When ordering spare parts always give: model, lifting capacity, jaw opening and serial number as well as the needed spare parts.

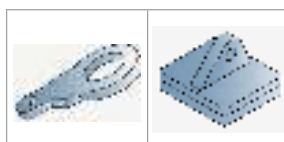

Type	Lifting eye	Jaw blocks
0.25 TBLC	55.550050	55.501255
0.5 TBLC	55.550050	55.501255
1 TBLC	55.550850	55.501255
1.5 TBLC	55.550150	55.501105
2 TBLC	55.550850	55.501255
3 TBLC	55.550150	55.501105

Spareparts - TBC







Type	Lifting eye
0.5 TTL	55.550050
1 TTL	55.550850
2 TTL	55.550150
3 TTL	55.550150

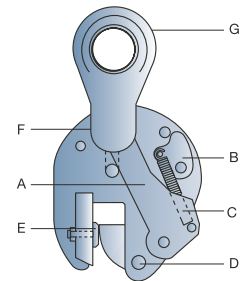





Spareparts - Hardox



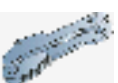



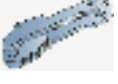

All spare parts are available either separately or as repair sets. It is recommended when any parts are damaged to replace them straight away and not to take any risk.

When ordering spare parts always give: model, lifting capacity, jaw opening and serial number as well as the needed spare parts

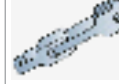

Type	A	B	C	D	E	F	G
							
	Cam assy	Lock leverassy	Spring	Campin	Pivot	Shackle pin	Lifting shackle
0.75 TS-H	55.550020.5	55.550031	55.250000	55.550029	55.550019.5	55.550058	55.550050
1 TSE-H	55.550880.5	55.550831	55.250800	55.550829	55.550819.5	55.550858	55.550850
2 TSE-H	55.550920.5	55.550131	55.250100	55.550129	55.550119.5	55.550158	55.550150
3 TSE-H	55.550920.5	55.550131	55.250100	55.552929	55.550119.5	55.550158	55.550150
4.5 TSE-H	55.552220.5	55.552431	55.250200	55.550329	55.550219.5	55.550258	55.550250
6 TS-H	55.550320.5	55.550331	55.250300	55.550329	55.550219.5	55.550358	55.550350
7.5 TSE-H	55.552620.5	55.550431	55.250400	55.550429	55.550219.5	55.550458	55.550450

Type	A	B	C	D	E	F	H
							
	Cam assy	Lock leverassy	Spring	Campin	Pivot	Shackle pin	Lifting shackle
0.75 TSU-H	55.550020.5	55.550031	55.250000	55.550029	55.550019.5	55.550058	55.555050
1 TSEU-H	55.550880.5	55.550831	55.250800	55.550829	55.550819.5	55.550858	55.555850
2 TSEU-H	55.550920.5	55.550131	55.250100	55.550129	55.550119.5	55.550158	55.555150
3 TSEU-H	55.550920.5	55.550131	55.250100	55.552929	55.550119.5	55.550158	55.555150
4.5 TSEU-H	55.552220.5	55.552431	55.250200	55.550329	55.550219.5	55.550258	55.555250
6 TSU-H	55.550320.5	55.550331	55.250300	55.550329	55.550219.5	55.550358	55.555350
7.5 TSEU-H	55.552620.5	55.550431	55.250400	55.550429	55.550219.5	55.550458	55.555450

Type	A	B	C	D	E	F	G	I	J
									
	Cam assy	Lock leverassy	Spring	Campin	Pivot	Shackle pin	Lifting shackle	Link arr.	Link pin
0.75 TSMP-H	55.550020.5	55.550031	55.250000	55.550029	55.550019.5	55.550058	55.550050	55.550060	55.550059
1 TSEMP-H	55.550880.5	55.550831	55.250800	55.550829	55.550819.5	55.550858	55.550850	55.550860	55.570128
2 TSEMP-H	55.550920.5	55.550131	55.250100	55.550129	55.550119.5	55.550158	55.550150	55.550160	55.550129
3 TSEMP-H	55.550920.5	55.550131	55.250100	55.552929	55.550119.5	55.550158	55.550150	55.550160	55.550129
4.5 TSEMP-H	55.552220.5	55.552431	55.250200	55.550329	55.550219.5	55.550258	55.550250	55.550260	55.550259
6 TSMP-H	55.550320.5	55.550331	55.250300	55.550329	55.550219.5	55.550358	55.550350	55.550360	55.550329
7.5 TSEMP-H	55.552620.5	55.550431	55.250400	55.550429	55.550219.5	55.550458	55.550450	55.550460	55.550329

Spareparts Sets

REPAIR SETS.

Capacity	Set nr.	Jaw opening	Cam assy	Spring	Cam pin	Pivot
0.75 T	55.RS650000	0 - 13 mm	55.550020	55.250000	55.550029	55.550019
1 T	55.RS650801	0 - 18 mm	55.550820	55.250800	55.550829	55.550819
1 TSE	55.RS650811	0 - 25 mm	55.550880	55.250800	55.550829	55.550819
1.5 T	55.RS650101	0 - 20 mm	55.550120	55.250100	55.550129	55.550119
2 T	55.RS650901	0 - 35 mm	55.550920	55.250100	55.550129	55.550119
3 T	55.RS650911	0 - 35 mm	55.550920	55.250100	55.552929	55.550119
4.5 T	55.RS650201	0 - 25 mm	55.550220	55.250200	55.550329	55.550219
4.5 TSE	55.RS650221	0 - 45 mm	55.552220	55.250200	55.550329	55.550219
6 T	55.RS650301	0 - 32 mm	55.550320	55.250300	55.550329	55.550219
7.5 T	55.RS650401	0 - 40 mm	55.550420	55.250400	55.550429	55.550219
7.5 TSE	55.RS650611	0 - 55 mm	55.552620	55.250400	55.550429	55.550219
9 T	55.RS650612	0 - 55 mm	55.552620	55.250400	55.555529	55.550219
12 T	55.RS650501	0 - 52 mm	55.550520	55.250500	55.550529	55.550219
15 T - 17 T	55.RS650601	0 - 76 mm	55.550620	55.250600	55.550629	55.550619
20 T - 25 T	55.RS650701	0 - 80 mm	55.550720	55.250700	55.550729	55.550719
30 T	55.RS650711	10 - 90 mm	55.550720	55.250700	55.550929	55.550719

All spare parts are available either separately or as repair sets. It is recommended when any parts are damaged to replace them straight away and not to take any risk.

When ordering spare parts always give: model, lifting capacity, jaw opening and serial number as well as the needed spare parts.

REVISION SETS.

Capacity	Set nr.	Lock leverassy	Cam assy	Spring	Cam pin	Pivot
0.75 T	55.RV650000	55.550031	55.550020	55.250000	55.550029	55.550019
1 T	55.RV650801	55.550831	55.550820	55.250800	55.550829	55.550819
1 TSE	55.RV650811	55.550831	55.550880	55.250800	55.550829	55.550819
1.5 T	55.RV650101	55.550131	55.550120	55.250100	55.550129	55.550119
2 T	55.RV650901	55.550131	55.550920	55.250100	55.550129	55.550119
3 T	55.RV650911	55.550131	55.550920	55.250100	55.552929	55.550119
4.5 T	55.RV650201	55.550231	55.550220	55.250200	55.550329	55.550219
4.5 TSE	55.RV650221	55.552431	55.552220	55.250200	55.550329	55.550219
6 T	55.RV650301	55.550331	55.550320	55.250300	55.550329	55.550219
7.5 T	55.RV650401	55.550431	55.550420	55.250400	55.550429	55.550219
7.5 TSE	55.RV650611	55.552431	55.552620	55.250400	55.550429	55.550219
9 T	55.RV650612	55.552531	55.552620	55.250400	55.555529	55.550219
12 T	55.RV650501	55.550531	55.550520	55.250500	55.550529	55.550219
15 T - 17 T	55.RV650601	55.550631	55.550620	55.250600	55.550629	55.550619
20 T - 25 T	55.RV650701	55.550731	55.550720	55.250700	55.550729	55.550719
30 T	55.RV650711	55.550731	55.550720	55.250700	55.550929	55.550719

REPAIR SETS - HARDOX.

Capacity	Set nr.	Jaw opening	Cam assy	Spring	Cam pin	Pivot
0,75 T	55.RS650000.5	0 - 13 mm	55.550020.5	55.250000	55.550029	55.550019.5
1 T	55.RS650801.5	0 - 18 mm	55.550820.5	55.250800	55.550829	55.550819.5
1 T TSE	55.RS650811.5	0 - 25 mm	55.550880.5	55.250800	55.550829	55.550819.5
1.5 T	55.RS650101.5	0 - 20 mm	55.550120.5	55.250100	55.550129	55.550119.5
2 T	55.RS650901.5	0 - 35 mm	55.550920.5	55.250100	55.550129	55.550119.5
3 T	55.RS650911.5	0 - 35 mm	55.550920.5	55.250100	55.552929	55.550119.5
4.5 TSE	55.RS650221.5	0 - 45 mm	55.552220.5	55.250200	55.550329	55.550219.5
6 T	55.RS650301.5	0 - 32 mm	55.550320.5	55.250300	55.550329	55.550219.5
7.5 T TSE	55.RS650611.5	0 - 55 mm	55.552620.5	55.250400	55.550429	55.550219.5

Safely lifting vertical

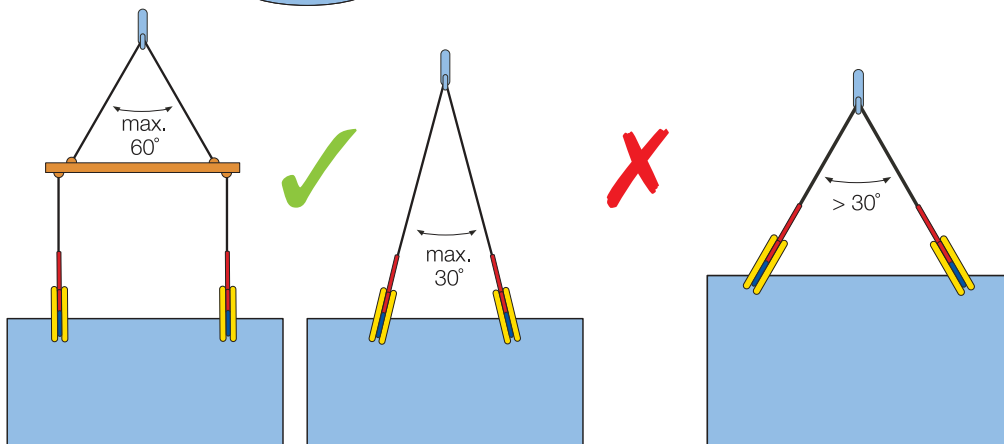
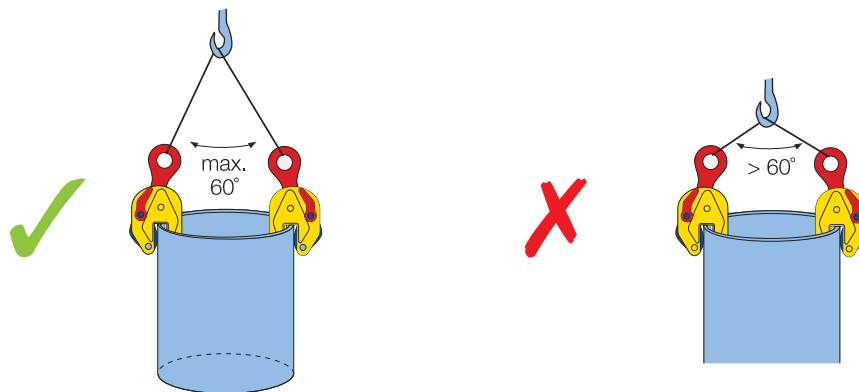
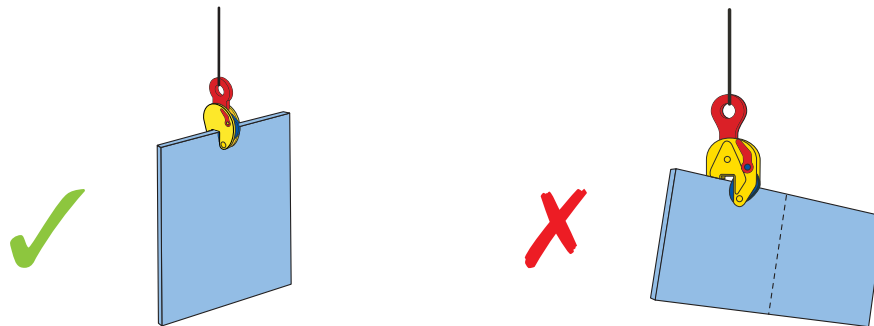

Safely lifting horizontal

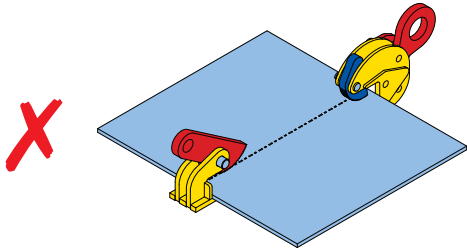
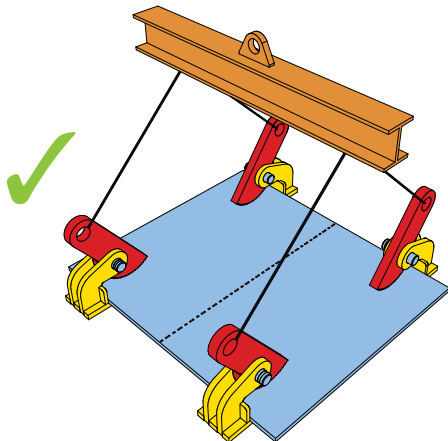
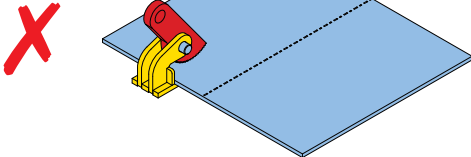
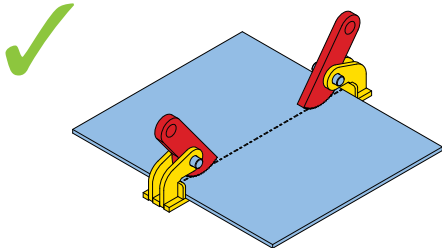
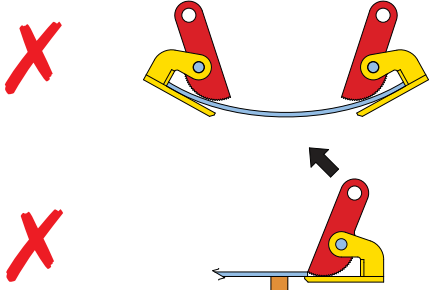
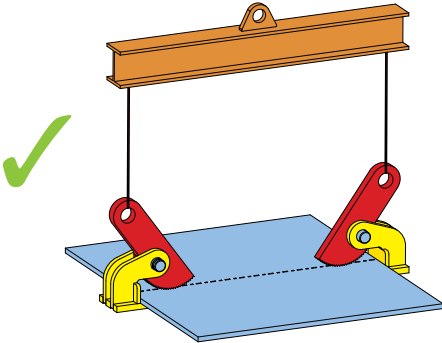
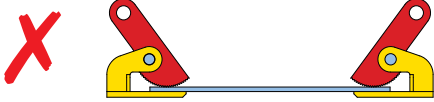



Contents	Page	123
Introduction ELD	Page	124
Certificates	Page	125
Quality control	Page	126
Markings	Page	127
Working load table	Page	128
Product overview	Page	129 - 132
Alloy steel chains Grade 8	Page	133
Master links	Page	134
Connecting links	Page	135
Web sling connecting links	Page	135
Eye hooks	Page	136
Clevis hooks	Page	137
Self locking hooks	Page	138
Shortening hooks	Page	139
Shortening hooks with safety	Page	140
Self locking swivel hooks	Page	141
Swivel hooks	Page	142 - 143
Swivels	Page	143 - 144
Sliding choker hooks	Page	145
Ramshorn swivel hooks	Page	145
Shank self locking hooks	Page	146
Shank hooks	Page	146
Machined shank self-locking hook	Page	147
Machined shank hooks	Page	147
Lifting Points	Page	148
Swivel basket	Page	148
Weld-on bucket hooks	Page	149
Load binders	Page	150
Tags for slings	Page	151
Chain assemblies	Page	152 - 153
Round sling assemblies	Page	154
Lashing chains	Page	155
Spare parts	Page	156 - 158
General instruction for use	Page	159 - 161
Load Capacity DIN 15402 and DIN 15401 hooks	Page	162
Products overview DIN hooks and blocks	Page	162

ELD introduction



ELD division of the Feat Group SpA is leader in design, application engineering and production of wire rope fittings, grade 8 chain accessories, blocks and OEM components. The art of forging steel is a tradition at Feat Group S.p.A. The heritage as a forging shop has enabled the company to become a worldwide supplier of a wide range of products that are used directly or indirectly in petrochemical, nuclear, automotive, agricultural, earth moving and lifting industries. The core of our business is drop forgings up to 100 kg, hammer forgings up to 500 kg and open die forgings for bigger sizes. The strength of the company lies in the highly qualified staff of technicians. Starting from the specific enquiries of our customers, draughtsman and engineers analyze the production problem beforehand through FMEA techniques, and by means of computerized simulations of the forging dynamics they are able to realize prototypes of the items to be forged (rapid prototyping) in very short time periods.

All products are certified (TUV, Lloyd's Register, Nippon Kaiji Kyokai, DNV, BG) and covered by a specific insurance for product liability. The certified quality system ISO 9001 permits the monitoring of all the aspects of the organization, and the identification and traceability of the main documents of the company, with a view to achieving a continual and consolidated improvement. In 2009 ELD obtained the H-88 approval by BGM Nord Süd.

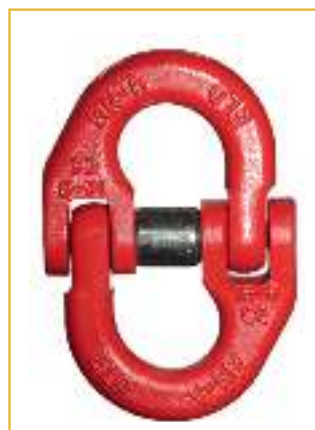

Certificates



Quality control



Design



Rapid prototyping



Raw materials inspection



CNC machining



Dyes making



Forging lines



Heat treatment



Spectrographic analysis



Metallographic test



Magnaflux control



Cycle testing



150 tons tensile testing

Markings

According to the EN818-4 all Grade 80 chain slings should be equipped with an octagonal tag. All required markings are shown below.

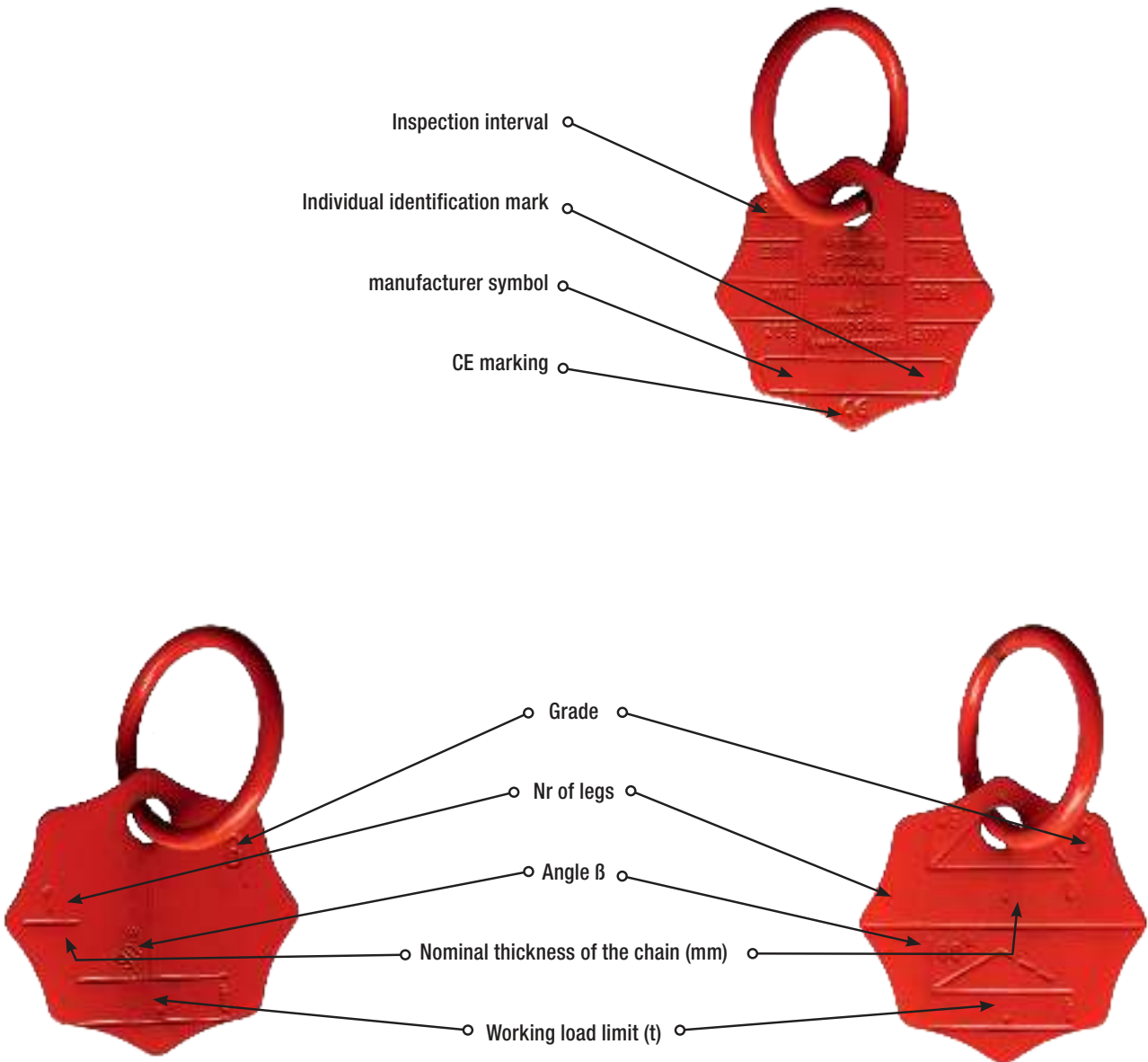

Working load table

Working load limit Grade 80 chain slings in t

Nominal thickness of the chain in mm	1-leg		2-leg		3- and 4-leg		Endless sling in choke
	Angle β	0°	0° < β ≤ 45°	45° < β ≤ 60°	0° < β ≤ 45°	45° < β ≤ 60°	
	Load factor	1	1,4	1	2,1	1,5	1,6
6		1,12	1,6	1,12	2,36	1,7	1,8
7		1,5	2,12	1,5	3,15	2,2	2,5
8		2	2,8	2	4,25	3	3,15
10		3,15	4,25	3,15	6,7	4,75	5
13		5,3	7,5	5,3	11,2	8	8,5
16		8	11,2	8	17	11,8	12,5
19		11,2	16	11,2	23,6	17	18
20		12,5	17	12,5	26,5	19	20
22		15	21,2	15	31,5	22,4	23,6
26		21,2	30	21,2	45	31,5	33,5
32		31,5	45	31,5	67	47,5	50

The table gives WLL information based on normal use conditions. In case of more demanding conditions such as edge loading, high temperatures asymmetric loading, the given WLL values have to be reduced using the reducing factors mentioned below.

Inclinations $\beta > 60^\circ$ are prohibited

Reduced Working Load under unfavorable circumstances

The WLL of a chain sling should be reduced if used at temperatures $> 200^\circ\text{C}$ according to the table:

Temperatur	-40°C < T < +200°C	+200°C < T < +300°C	+300°C < T < +400°C
Load factor	1	0,9	0,75







In case of temperatures below -40°C , the manufacturer has to be consulted before using the chain.

In case of asymmetric loading (individual chain legs have various angles β or the different legs are unevenly loaded), the Working Load has to be reduced with 50%.

Asymmetric loading				
	2-leg		3- and 4-leg	
	0° < β ≤ 45°	45° < β ≤ 60°	0° < β ≤ 45°	45° < β ≤ 60°
Load factor	1	1	1,4	1







The use under unfavorable conditions (chemical, abrasive environment) should be negotiated with the producer. The sling chains must not be placed in acid solutions nor be subjected to acid steams.





Product overview

Chain size							
				181	191	101	100
	Page 133	Page 134	Page 134	Page 135	Page 135	Page 136	Page 136
6	41.01.06.0000	41.02.12.0707	41.10.34.0606	41.19.06.0000	-	41.22.06.0000	-
7	41.01.07.0000	41.02.12.0707	41.10.34.0707	41.19.08.0000	41.20.08.0000	41.22.07.0000	41.23.08.0000
8	41.01.08.0000	41.02.12.0807	41.10.34.0808	41.19.08.0000	41.20.08.0000	41.22.08.0000	41.23.08.0000
10	41.01.10.0000	41.02.12.1008	41.10.34.1010	41.19.10.0000	41.20.10.0000	41.22.10.0000	41.23.10.0000
13	41.01.13.0000	41.02.12.1310	41.10.34.1313	41.19.13.0000	41.20.13.0000	41.22.13.0000	41.23.13.0000
16	41.01.16.0000	41.02.12.1613	41.10.34.1616	41.19.16.0000	41.20.16.0000	41.22.16.0000	41.23.16.0000
18	41.01.18.0000	41.02.12.1816	41.10.34.1818	-	-	-	-
19	41.01.19.0000	41.02.1.22318	41.10.34.2020	41.19.20.0000	-	41.22.19.0000	-
20	41.01.20.0000	41.02.12.0020	41.10.34.2020	41.19.20.0000	-	41.22.22.0000	41.23.20.0000
22	41.01.22.0000	41.02.12.2823	41.10.34.2222	41.19.22.0000	-	41.22.26.0000	-
26	41.01.26.0000	41.02.12.3228	41.10.34.2626	41.19.26.0000	-	-	-
32	41.01.32.0000	41.02.12.3632		41.19.32.0000	-	-	-

Chain size							
	179	102	103	183	184	105	106
	Page 137	Page 138	Page 138	Page 139	Page 139	Page 141	Page 141
6	41.21.06.0000	41.25.06.0000	41.24.06.0000	-	41.26.06.0000	41.30.06.0000	41.31.06.0000
7	41.21.08.0000	41.25.08.0000	41.24.08.0000	41.27.08.0000	41.26.08.0000	41.30.08.0000	41.31.08.0000
8	41.21.08.0000	41.25.08.0000	41.24.08.0000	41.27.08.0000	41.26.08.0000	41.30.08.0000	41.31.08.0000
10	41.21.10.0000	41.25.10.0000	41.24.10.0000	41.27.10.0000	41.26.10.0000	41.30.10.0000	41.31.10.0000
13	41.21.13.0000	41.25.13.0000	41.24.13.0000	41.27.13.0000	41.26.13.0000	41.30.13.0000	41.31.13.0000
16	41.21.16.0000	41.25.16.0000	41.24.16.0000	41.27.16.0000	41.26.16.0000	41.30.16.0000	41.31.16.0000
18	-	-	-	-	-	-	-
19	-	-	-	-	-	-	-
20	41.21.20.0000	-	-	-	41.26.20.0000	-	-







Product overview







Chain size							
	167	168	169	117	118	119	145
	Page 143	Page 142	Page 142	Page 143	Page 144	Page 144	Page 145
6	41.32.06.0000	41.33.06.0000	-	-	-	-	-
7	41.32.07.0000	41.33.07.0000	-	41.37.08.0000	41.38.08.0000	-	-
8	41.32.08.0000	41.33.08.0000	-	41.37.08.0000	41.38.08.0000	-	-
10	41.32.10.0000	41.33.10.0000	-	41.37.10.0000	41.38.10.0000	-	-
13	41.32.13.0000	41.33.13.0000	-	41.37.13.0000	41.38.13.0000	-	41.35.005400
16	41.32.16.0000	41.33.16.0000	41.34.16.0000	41.37.16.0000	41.38.16.0000	41.39.16.0000	41.35.008000
18	-	-	-	-	-	-	-
19	41.32.19.0000	41.33.19.0000	41.34.19.0000	41.37.19.0000	41.38.19.0000	41.39.19.0000	41.35.011500
20	-	-	-	-	-	-	-
22	41.32.22.0000	41.33.22.0000	41.34.22.0000	41.37.22.0000	41.38.22.0000	41.39.22.0000	41.35.016000
26	41.32.26.0000	41.33.26.0000	41.34.26.0000	41.37.26.0000	41.38.26.0000	41.39.26.0000	41.35.022000
32	41.32.32.0000	41.33.32.0000	41.34.32.0000	41.37.32.0000	41.38.32.0000	41.39.32.0000	41.35.031500

Chain size					
	104	121	521	504	113
	Page 146	Page 146	Page 147	Page 147	Page 148
6	41.40.06.0000	41.41.06.0000	41.43.06.0000	41.42.06.0000	41.44.06.0000
7	41.40.08.0000	41.41.07.0000	41.43.07.0000	41.42.08.0000	-
8	41.40.08.0000	41.41.08.0000	41.43.08.0000	41.42.08.0000	41.44.08.0000
10	41.40.10.0000	41.41.10.0000	41.43.10.0000	41.42.10.0000	41.44.10.0000
13	41.40.13.0000	41.41.13.0000	41.43.13.0000	41.42.13.0000	41.44.13.0000
16	41.40.16.0000	41.41.16.0000	41.43.16.0000	41.42.16.0000	41.44.16.0000
18	-	-	-	-	-
19	-	41.41.19.0000	41.43.19.0000	-	41.44.19.0000
20	-	-	-	-	-
22	-	41.41.22.0000	41.43.22.0000	-	41.44.22.0000
26	-	41.41.26.0000	41.43.26.0000	-	41.44.26.0000
32	-	41.41.32.0000	41.43.32.0000	-	41.44.32.0000

Product overview

WLL				
	112	700C	700U	115
	Page 145	Page 149	Page 149	Page 148
0,3t	-	-	-	41.73.08.0000
0,5t	-	-	41.71.000500	-
0,6t	-	-	-	41.73.10.0000
1t	-	41.70.001000	41.71.001000	41.73.12.0000
1,5t	41.36.001500	-	-	-
1,6t	-	-	-	41.73.16.0000
2t	41.36.002000	41.70.002000	41.71.002000	-
2,5t	-	-	-	41.73.20.0000
3t	41.36.003000	41.70.003000	41.71.003000	-
4t	-	41.70.004000	41.71.004000	41.73.24.0000
5t	41.36.005000	41.70.005000	-	-
6t	-	41.70.006000	41.71.006000	-
6,3t	-	-	-	41.73.30.0000
8t	-	41.70.008000	41.71.008000	-
10t	-	41.70.010000	-	-
18t	-	41.70.018000	-	-





Chain size						
	183L	184L			1PELP	
	Page 140	Page 140	Page 150	Page 150	Page 158	Page 158
8	41.29.08.0000	41.28.08.0000	30.08.08.001	30.08.08.000	41.80.000081	30.00.08P
10	41.29.10.0000	41.28.10.0000	30.08.10.001	30.08.10.000	41.80.000082	30.00.10P
13	41.29.13.0000	41.28.13.0000	30.08.13.001	30.08.13.000	41.80.000083	30.00.13P
16	41.29.16.0000	41.28.16.0000	-	30.08.16.000	41.80.000084	
20					41.80.000085	

Spare parts							
	RC	1DS5	RU	1PE	1SPEN	1DSEN	102KR
	Page 156	Page 156	Page 156	Page 157	Page 157	Page 157	Page 158
For hooks	C	112	U	103/179/184	179/100	101/121/167/ 168/169/521	102/103/104/ 105/106/504





Product overview

Tags						
	Page 151	Page 151	Page 151	Page 151	Page 151	Page 151
	41.99.000001	41.99.000002	41.99.000003	41.99.000004	41.99.000005	41.99.000010

Chain assemblies				
	Page 152	Page 152	Page 152	Page 152

Roundsling assemblies				
	Page 154	Page 154	Page 154	Page 154

Lashing chains		
	Page 155	Page 155

Corner protection					
	Page 70	Page 70	Page 68	Page 68	Page 70

Alloy steel chains Grade 8

ALLOY STEEL CHAINS GRADE 8, EN818-2

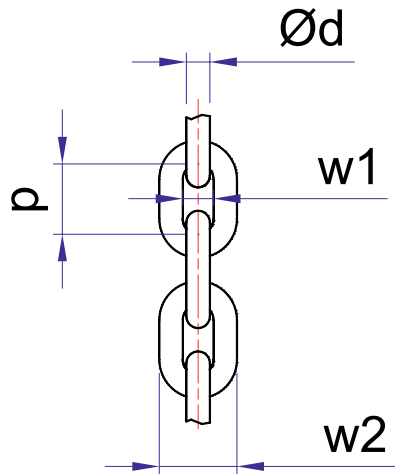

Ref. nr. black painted	Chain size	WLL (kg)	Breaking load kN	Proof test kN	Dimensions (mm)				Weight (kg/m)	Standard length (m)
					d	p	w1	w2		
41.01.06.0000	6-8	1120	45,2	28,3	6	18	7,8	19,8	0,8	100
41.01.07.0000	7-8	1500	61,6	38,5	7	21	9,1	23,1	1,1	100
41.01.08.0000	8-8	2000	80,4	50,3	8	24	10,4	26,4	1,4	100
41.01.10.0000	10-8	3150	126	78,5	10	30	13,0	33	2,2	100
41.01.13.0000	13-8	5300	212	133	13	39	16,9	42,9	3,8	100
41.01.16.0000	16-8	8000	322	201	16	48	20,8	52,8	5,7	100
41.01.18.0000	18-8	10000	407	254	18	54	23,4	59,4	7,3	100
41.01.20.0000	20-8	12500	503	314	20	60	26,0	66	9	100
41.01.22.0000	22-8	15000	608	380	22	66	28,6	72,6	10,9	100
41.01.26.0000	26-8	21200	849	531	26	78	33,8	85,8	15,2	50
41.01.32.0000	32-8	31500	1290	804	32	96	41,6	105,6	23	50

Elongation at break is min 20%

Relation of WLL : Breaking load : Proof test = 1 : 2,5 : 4 (200 : 500 : 800 Mpa)

See Working load table for details regarding WLL for different applications and WLL reducing factors.

Master links

MASTER LINKS

Master links according to EN 1677-4 (former DIN 5688-8), red epoxy painted, without flatpoint

Ref. nr.	Chain size		WLL	Dimensions (mm)			Weight	
	1-leg	2-leg		(kg)	A	B		C
41.02.12.0707	6/7	6	A13	1600	13	110	60	0,34
41.02.12.0807	8	7	A16	2120	16	110	60	0,53
41.02.12.1008	10	8	A18	3150	18	135	75	0,80
41.02.12.1310	13	10	A22	5300	22	160	90	1,50
41.02.12.1613	16	13	A26	8000	26	180	100	2,30
41.02.12.1816	18	16	A32	11200	32	200	110	3,90
41.02.1.22318	20/22/23	18	A36	16000	36	260	140	6,35
41.02.12.0020		20	A40	18000	40	300	160	9,00
41.02.12.2823	26/28	22/23	A45	25000	45	340	180	12,80
41.02.12.3228	32	26/28	A51	35500	51	350	190	17,2
41.02.12.3632	36	32	A57	45000	57	400	200	24,2

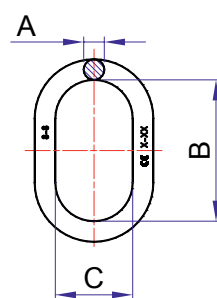

Ref. nr.	Chain size		WLL	Dimensions (mm)						Weight
	3- and 4-legs			(kg)	A	B	C	a	b	
41.10.34.0606	6	AK18	2360	18	135	75	13	54	25	1.16
41.10.34.0707	7	AK18	3150	18	135	75	13	54	25	1.16
41.10.34.0808	8	AK22	4250	22	160	90	16	70	34	2.22
41.10.34.1010	10	AK26	6700	26	180	100	18	85	40	3.36
41.10.34.1313	13	AK32	11200	32	200	110	22	115	50	6.02
41.10.34.1616	16	AK36	17000	36	260	140	26	140	65	9.94
41.10.34.1818	18	AK45	21200	45	340	180	32	150	70	18.90
41.10.34.2020	20	AK51	26500	51	350	190	32	150	70	23.3
41.10.34.2222	22/23	AK51	35500	51	350	190	36	170	75	25.8
41.10.34.2626	26	AK57	45000	57	400	200	40	170	80	35.20

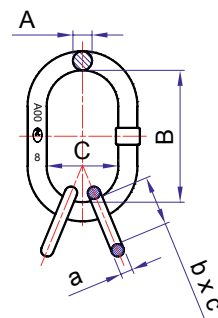

Connecting links

Web sling connecting links

CONNECTING LINK, SERIE 181 (ACCORDING TO EN1677-1)

Ref. nr.	Chain size	WLL	Dimensions (mm)						Weight
			(t)	A	B	øC	D	E	
41.19.06.0000	6-8	1,12	7	11	13	16	16,5	43	0,07
41.19.08.0000	7/8-8	2	9,5	13,5	18	20	23	55	0,16
41.19.10.0000	10-8	3,15	12	17	22	25	28	67	0,30
41.19.13.0000	13-8	5,3	17	22	26	30	34	84	0,60
41.19.16.0000	16-8	8	22	28	32	36	41	104	1,10
41.19.20.0000	20-8	12,5	25	33	40	44	49	120	1,90
41.19.22.0000	22-8	15	28	38	45	50	58	142	2,80
41.19.26.0000	26-8	21,2	32	48	50	54	65	170	4,90
41.19.32.0000	32-8	31,5	38	62	56	68	80	190	8,50

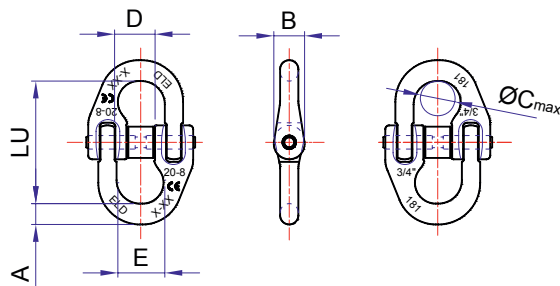

WEB SLING CONNECTING LINK, SERIE 191 (ACCORDING TO EN1677-1)

Ref. nr.	Chain size	WLL	Dimensions (mm)					Weight
			(t)	A	B	C	D	
41.20.08.0000	7/8-8	2	10,5	24	40	20	62	0,3
41.20.10.0000	10-8	3,15	12	28	50	25	78	0,6
41.20.13.0000	13-8	5,3	17	33	60	30	97	1,0
41.20.16.0000	16-8	8	21	42	75	36	118	2,0

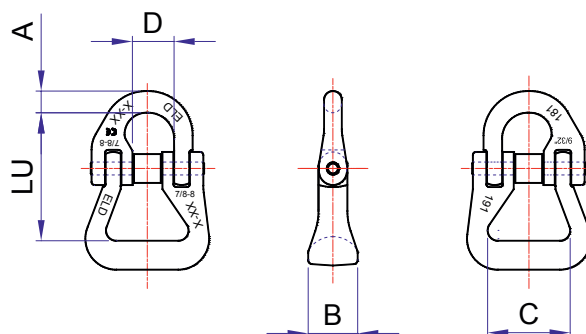

Eye hooks

EYE HOOK WITH SAFETY LATCH, SERIE 101 (ACCORDING TO EN1677-2)

Ref. nr.	Chain size	WLL	Dimensions (mm)										Weight
			(t)	A	B	C	D	D1	E	F	G	H	
41.22.06.0000	6-8	1,25	9,5	19	77	23	20	21	15	15	31	82	0,33
41.22.07.0000	7-8	1,6	11	25	82	26	22	23	18	18	34	93	0,45
41.22.08.0000	8-8	2,5	13	27	94	27	23	27	23	23	38	105	0,76
41.22.10.0000	10-8	3,2	15	32	106	31	27	31	23	24	42	121	1,08
41.22.13.0000	13-8	5,4	18	38	132	40	35	37	29	30	50	146	1,82
41.22.16.0000	16-8	8	23	51	165	51	43	49	37	37	62	187	3,80
41.22.19.0000	19-8	11,5	29	64	198	58	53	60	43	46	75	230	7,40
41.22.22.0000	22-8	16	33	70	222	66	58	67	52	57	84	255	10,70
41.22.26.0000	26-8	22	39	90	283	87	78	80	64	65	110	320	18,50

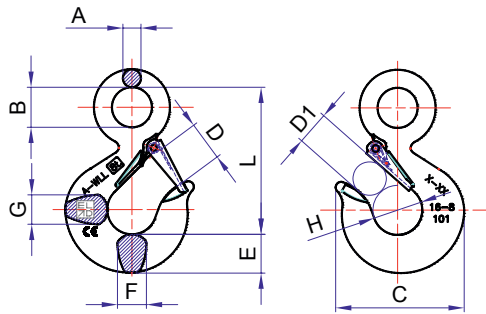

EYE HOOK WITH SAFETY LATCH, SERIE 100 (ACCORDING TO EN1677-2)

Ref. nr.	Chain size	WLL	Dimensions (mm)								Weight
			(t)	A	A1	B	C	D	E	F	
41.23.08.0000	7/8-8	2	29	27	36	17	30	12	24	94	0,52
41.23.10.0000	10-8	3,15	40	37	45	24	35	16	32	122	1,05
41.23.13.0000	13-8	5,3	48	45	54	30	43	18	38	152	1,95
41.23.16.0000	16-8	8	56	53	70	35	50	24	50	202	4,40
41.23.20.0000	20-8	12,5	65	62	88	42	64	27	60	240	8,00

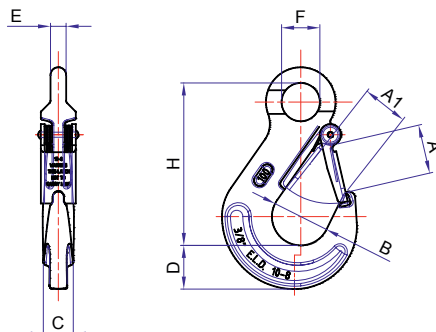

Clevis hooks

CLEVIS CHAIN HOOK WITH SAFETY LATCH, SERIE 179 (ACCORDING TO EN1677-2)

Ref. nr.	Chain size	WLL (t)	Dimensions (mm)										Weight (kg)
			A	A1	B	C	D	øF	G	ød	H	L	
41.21.06.0000	6-8	1,12	24	21,5	23	13	22	7,8	20	3	68	21	0,25
41.21.08.0000	7/8-8	2	29	27	36	20	31	10	28	3	85	22	0,70
41.21.10.0000	10-8	3,15	38	35	45	24	35	12,5	35	3	105	28	1,25
41.21.13.0000	13-8	5,3	46	42	58	30	42	16	38	4	132	36	2,20
41.21.16.0000	16-8	8	53	48	64	35	48	20	50	5	148	42	3,10
41.21.20.0000	20-8	12,5	66	60	80	44	58	24	60	5	187	49	5,90

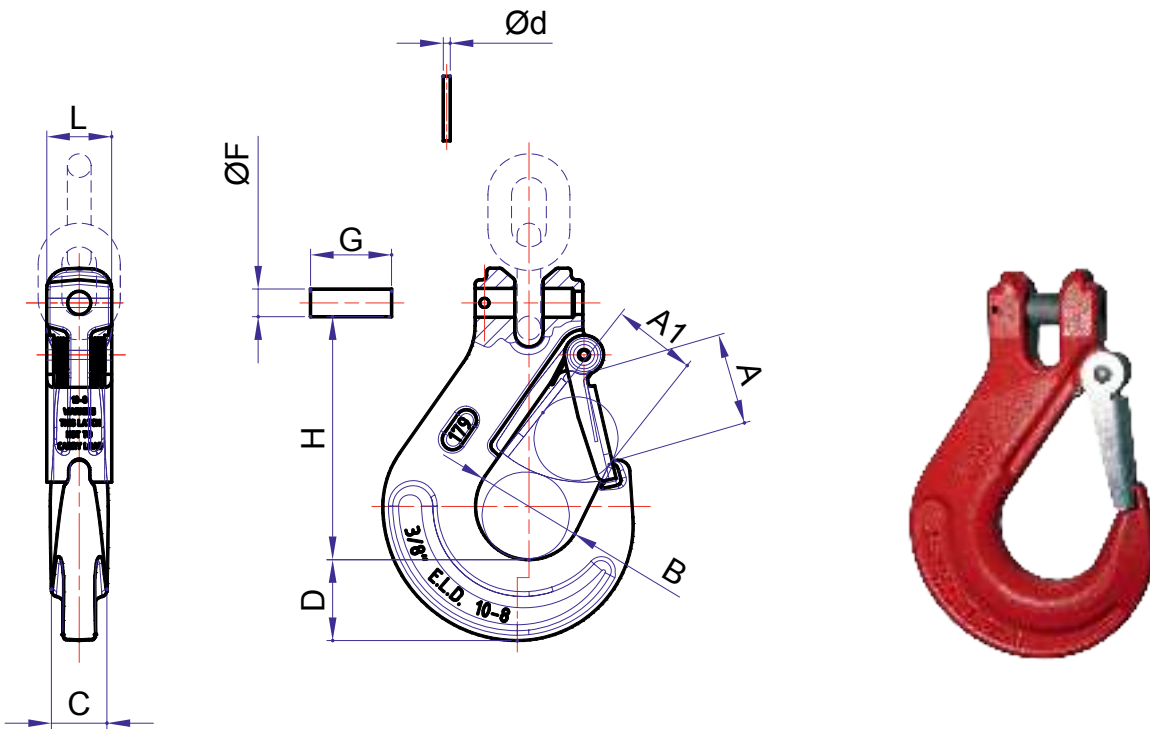

Self locking hooks

EYE SELF LOCKING HOOK, SERIE 102 (ACCORDING TO EN1677-3)

Ref. nr.	Chain size	WLL	Dimensions (mm)									Weight (kg)
			A	B	D	E	F	G	øH	L	M	
41.25.06.0000	6-8	1,12	6	22	28	20	14	139	35	107	11	0,5
41.25.08.0000	7/8-8	2	8	25	33	25	20	172	45	135	12	0,85
41.25.10.0000	10-8	3,15	10	32	44	35	27	218	58	168	14	1,6
41.25.13.0000	13-8	5,3	13	40	54,5	40	31	267	71	208	18	2,9
41.25.16.0000	16-8	8	16,5	50	67	52	40	330	84	254	22	5,9

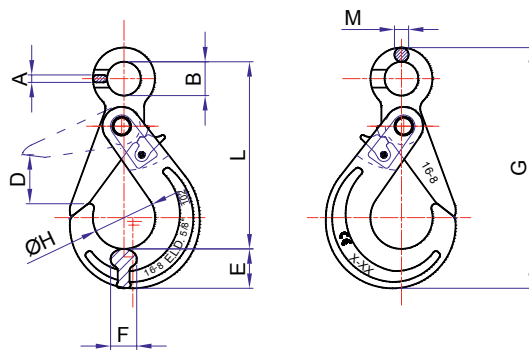

CLEVIS SELF LOCKING HOOK, SERIE 103 (ACCORDING TO EN1677-3)

Ref. nr.	Chain size	WLL	Dimensions (mm)									Weight (kg)
			C	D	E	øF	G	øD	øH	L	M	
41.24.06.0000	6-8	1,12	14	28	20	8	20	2,5	35	99	135	0,55
41.24.08.0000	7/8-8	2	20	33	25	10	28	3	45	122	165	0,9
41.24.10.0000	10-8	3,15	27	44	35	12,5	35	3	58	151	207	1,65
41.24.13.0000	13-8	5,3	31	54,5	40	16	38	4	71	184	255	3,1
41.24.16.0000	16-8	8	40	67	52	20	50	5	84	212	300	6,1

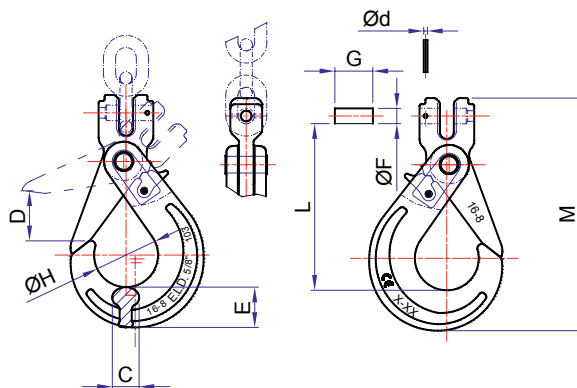

Shortening hooks

EYE GRAB HOOK, SERIE 183 (ACCORDING TO EN1677-1)

Ref. nr.	Chain size	WLL	Dimensions (mm)							Weight
			(t)	A	B	C	øD	E	F	
41.27.08.0000	7/8-8	2	35	15	54	25	63	95,5	30	0,31
41.27.10.0000	10-8	3,15	46	20	75	35	79	124	43	0,75
41.27.13.0000	13-8	5,3	57	25	93	40	98	154	52	1,52
41.27.16.0000	16-8	8	68	30	108	52	116	179	64	2,20

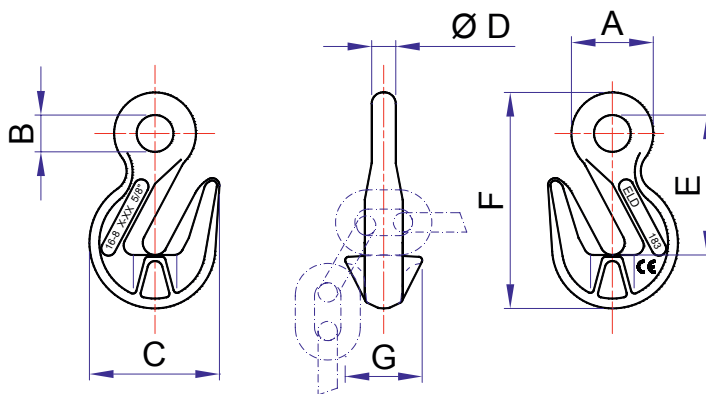

CLEVIS GRAB HOOK, SERIE 184 (ACCORDING TO EN1677-1)

Ref. nr.	Chain size	WLL	Dimensions (mm)									Weight
			(t)	A	B	C	ød	E	øF	G	H	
41.26.06.0000	6-8	1,12	30	17	41	3	39,5	7,8	20	72	27	0,16
41.26.08.0000	7/8-8	2	36	22	54	3	54	10	28	96	30	0,33
41.26.10.0000	10-8	3,15	46	28	75	3	70	12,5	35	124	43	0,80
41.26.13.0000	13-8	5,3	57	36	93	4	86	16	38	154	52	1,60
41.26.16.0000	16-8	8	70	42	108	5	101	20	50	179	64	2,30
41.26.20.0000	20-8	12,5	80	79	134	5	123	24	60	219	90	4,8

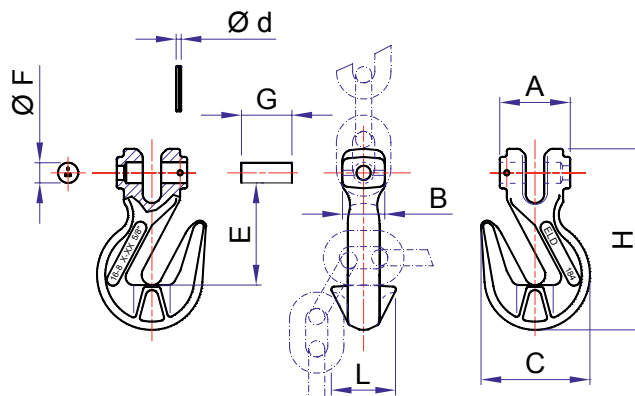

Shortening hooks with safety

EYE GRAB HOOK WITH SAFETY, SERIE 183L (ACCORDING TO EN1677-1)

Ref. nr.	Chain size	WLL	Dimensions (mm)							Weight
			A	B	C	øD	E	F	G	
41.29.08.0000	7/8-8	2	35	15	54	10	63	95,5	30	0,31
41.29.10.0000	10-8	3,15	46	20	75	13	79	124	43	0,75
41.29.13.0000	13-8	5,3	57	25	93	16	98	154	52	1,52
41.29.16.0000	16-8	8	68	30	108	20	116	179	64	2,20

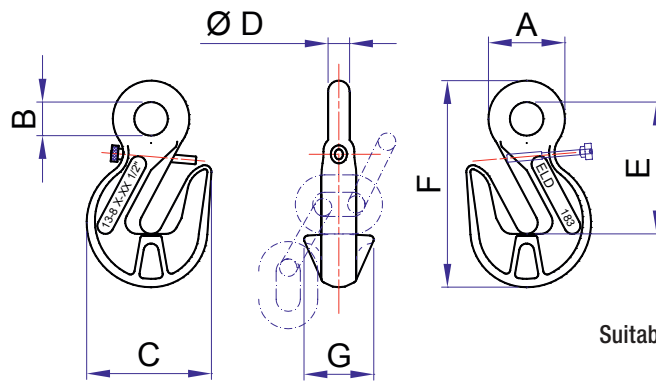

Suitable for lifting and lashing purposes

CLEVIS GRAB HOOK AND SAFETY, SERIE 184L (ACCORDING TO EN1677-1)

Ref. nr.	Chain size	WLL	Dimensions (mm)									Weight
			A	B	C	ød	E	øF	G	H	L	
41.28.08.0000	7/8-8	2	36	22	54	3	54	10	28	96	30	0,33
41.28.10.0000	10-8	3,15	46	28	75	3	70	12,5	35	124	43	0,80
41.28.13.0000	13-8	5,3	57	36	93	4	86	16	38	154	52	1,60
41.28.16.0000	16-8	8	70	42	108	5	101	20	50	179	64	2,30

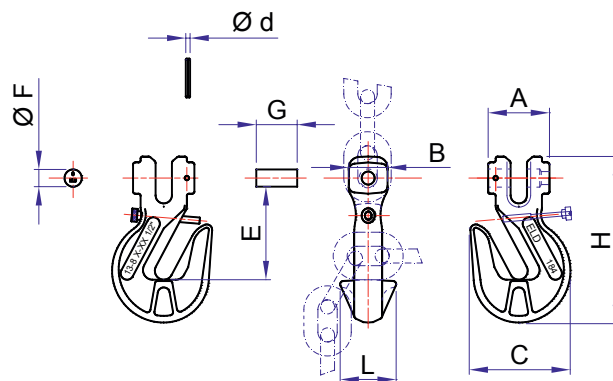

Suitable for lifting and lashing purposes

Self locking swivel hook

SELF LOCKING SWIVEL HOOK (ROTATION UNDER LOAD), SERIE 105 (ACCORDING TO EN1677-3)

Ref. nr.	Chain size	WLL (t)	Dimensions (mm)											Weight (kg)
			A	B	D	E	F	H	L	M	N	P	R	
41.30.06.0000	6-8	1,25	10	34	27	20	16	35	162	38	63	39	12,5	0,9
41.30.08.0000	7/8-8	2	10	31	33	26	20	45	188	38	63	39	12,5	1,3
41.30.10.0000	10-8	3,2	12,5	40	44	35	27	58	228	47	79	48	16	2
41.30.13.0000	13-8	5,4	15	50	54	41	30	71	285	58	96	60	19	4
41.30.16.0000	16-8	8	17,5	65	66	53	35	84	337	72	120	60	24	6,5

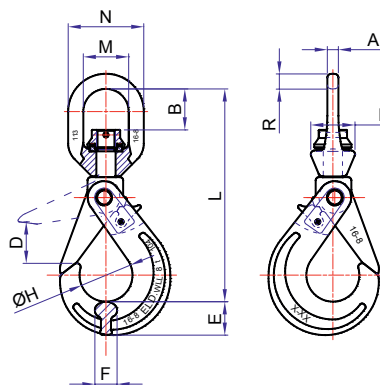

SELF LOCKING SWIVEL HOOK (NO ROTATION UNDER LOAD), SERIE 106 (ACCORDING TO EN1677-3)

Ref. nr.	Chain size	WLL (t)	Dimensions (mm)											Weight (kg)
			A	B	D	E	F	H	L	M	N	P	R	
41.31.06.0000	6-8	1,25	10	34	27	20	16	35	162	38	63	39	12,5	0,9
41.31.08.0000	7/8-8	2	10	31	33	26	20	45	188	38	63	39	12,5	1,3
41.31.10.0000	10-8	3,2	12,5	40	44	35	27	58	228	47	79	48	16	2
41.31.13.0000	13-8	5,4	15	50	54	41	30	71	285	58	96	60	19	4
41.31.16.0000	16-8	8	17,5	65	66	53	35	84	337	72	120	60	24	6,5

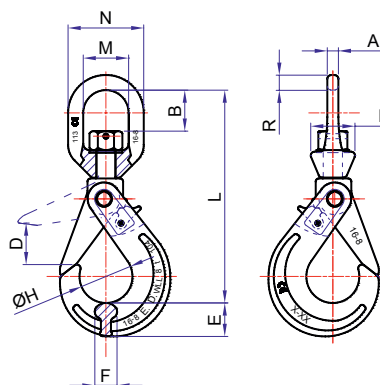

Swivel hooks

SWIVEL HOOK (ROTATION UNDER LOAD, LIGHT DUTY), SERIE 168 (ACCORDING TO EN1677-1)

Ref. nr.	Chain size	WLL	Dimensions (mm)													Weight
			(t)	A	B	C	D	D1	E	F	H	L	M	N	P	
41.33.06.0000	6-8	1,25	10	34	77	24	20	21	15	31	133	38	63	39	12,5	0,75
41.33.07.0000	7-8	1,6	10	31	82	26	22	23	18	34	140	38	63	39	12,5	0,9
41.33.08.0000	8-8	2,5	12,5	42	94	27	23	27	23	38	163	47	79	48	16	1,3
41.33.10.0000	10-8	3,2	12,5	40	106	32	27	31	23	42	172	47	79	48	16	1,6
41.33.13.0000	13-8	5,4	15	50	132	40	35	37	29	50	213	58	96	60	19	3,5
41.33.16.0000	16-8	8	17,5	65	165	51	43	49	37	62	266	72	120	70	24	6,5
41.33.19.0000	19-8	11,5	22	68	198	58	53	60	43	75	310	82	136	82	27	8,5
41.33.22.0000	22-8	16	24	84	222	66	58	67	52	84	352	92	154	92	31	15
41.33.26.0000	26-8	22	29	107	283	87	78	80	64	110	434	115	191	108	38	24,5
41.33.32.0000	32-8	31,5	34	117	339	97	87	94	80	120	512	132	222	132	45	54

See drawing below

SWIVEL HOOK (ROTATION UNDER LOAD, HEAVY DUTY), SERIE 169 (ACCORDING TO EN1677-1)

Ref. nr.	Chain size	WLL	Dimensions (mm)													Weight
			(t)	A	B	C	D	D1	E	F	H	L	M	N	P	
41.34.16.0000	16-8	8	17,5	65	165	51	43	49	37	62	266	72	120	70	24	6,5
41.34.19.0000	19-8	11,5	22	68	198	58	53	60	43	75	310	82	136	82	27	8,5
41.34.22.0000	22-8	16	24	84	222	66	58	67	52	84	352	92	154	92	31	15
41.34.26.0000	26-8	22	29	107	283	87	78	80	64	110	434	115	191	108	38	24,5
41.34.32.0000	32-8	31,5	34	117	339	97	87	94	80	120	512	132	222	132	45	54

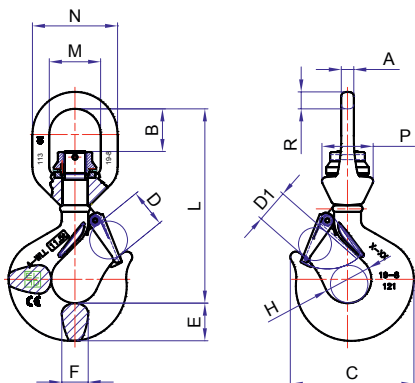

Lubrication nipple on demand (from sizes 19 to 32)

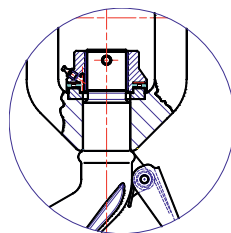

Swivel hooks

SWIVEL HOOK (NO ROTATION UNDER LOAD), SERIE 167 (ACCORDING TO EN1677-1)

Ref. nr.	Chain size	WLL	Dimensions (mm)													Weight (kg)
			A	B	C	D	D1	E	F	H	L	M	N	P	R	
41.32.06.0000	6-8	1,25	8	27	77	24	20	21	15	31	116	31	51	30	10	0,75
41.32.07.0000	7-8	1,6	10	31	82	26	22	23	18	34	140	38	63	39	12,5	0,9
41.32.08.0000	8-8	2,5	12,5	42	94	27	23	27	23	38	163	47	79	48	16	1,3
41.32.10.0000	10-8	3,2	12,5	40	106	32	27	31	23	42	172	47	79	48	16	1,6
41.32.13.0000	13-8	5,4	15	50	132	40	35	37	29	50	213	58	96	60	19	3,5
41.32.16.0000	16-8	8	17,5	65	165	51	43	49	37	62	266	72	120	70	24	6,5
41.32.19.0000	19-8	11,5	22	68	198	58	53	60	43	75	310	82	136	82	27	8,5
41.32.22.0000	22-8	16	24	84	222	66	58	67	52	84	352	92	154	92	31	15
41.32.26.0000	26-8	22	29	107	283	87	78	80	64	110	434	115	191	108	38	24,5
41.32.32.0000	32-8	31,5	34	117	339	97	87	94	80	120	512	132	222	132	45	54

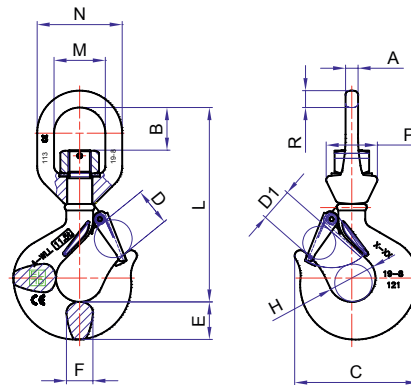

SWIVEL (NO ROTATION UNDER LOAD), SERIE 117 (ACCORDING TO EN1677-1)

Ref. nr.	Chain size	WLL	Dimensions (mm)								Weight (kg)
			A	B	C	D	E	F	G		
41.37.08.0000	7/8-8	2	63	31	38	12,5	149	174	39	1,1	
41.37.10.0000	10-8	3,2	79	40	47	16	180	212	48	1,5	
41.37.13.0000	13-8	5,4	96	50	58	19	224	262	60	3,5	
41.37.16.0000	16-8	8	120	65	72	24	280	328	70	5	
41.37.19.0000	19-8	11,5	136	68	82	27	308	362	82	7,5	
41.37.22.0000	22-8	16	154	84	92	31	370	432	92	12	
41.37.26.0000	26-8	22	191	107	115	38	447	523	108	21	
41.37.32.0000	32-8	31,5	222	117	132	45	527	617	132	36	

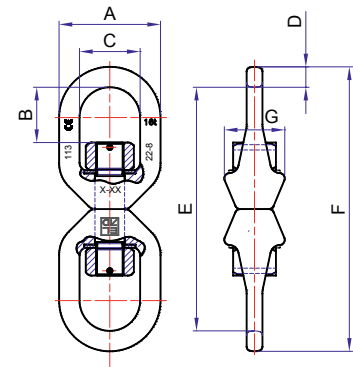

Swivels

SWIVEL (ROTATION UNDER LOAD, LIGHT DUTY), SERIE 118 (ACCORDING TO EN1677-1)

Ref. nr.	Chain size	WLL	Dimensions (mm)							Weight
			(t)	A	B	C	D	E	F	
41.38.08.0000	7/8-8	2	63	31	38	12,5	149	174	39	1,1
41.38.10.0000	10-8	3,2	79	40	47	16	180	212	48	1,5
41.38.13.0000	13-8	5,4	96	50	58	19	224	262	60	3,5
41.38.16.0000	16-8	8	120	65	72	24	280	328	70	5
41.38.19.0000	19-8	11,5	136	68	82	27	308	362	82	7,5
41.38.22.0000	22-8	16	154	84	92	31	370	432	92	12
41.38.26.0000	26-8	22	191	107	115	38	447	523	108	21
41.38.32.0000	32-8	31,5	222	117	132	45	527	617	132	36

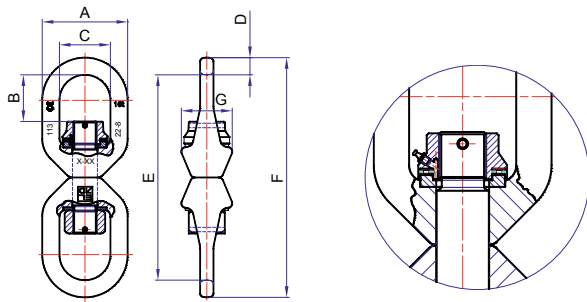

Lubrication nipple on demand (sizes 19-32 mm)

SWIVEL (ROTATION UNDER LOAD, HEAVY DUTY), SERIE 119 (ACCORDING TO EN1677-1)

Ref. nr.	Chain size	WLL	Dimensions (mm)							Weight
			(t)	A	B	C	D	E	F	
41.39.16.0000	16-8	8	120	65	72	24	280	328	70	5
41.39.19.0000	19-8	11,5	136	68	82	27	308	362	82	7,5
41.39.22.0000	22-8	16	154	84	92	31	370	432	92	12
41.39.26.0000	26-8	22	191	107	115	38	447	523	108	21
41.39.32.0000	32-8	31,5	222	117	132	45	527	617	132	36

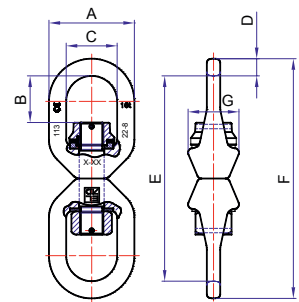

Lubrication nipple on demand (sizes 19-32 mm)

Sliding choker hooks Ramshorn swivel hook

SLIDING CHOKER HOOK, SERIE 112

Ref. nr.	Wire rope (mm)	Size (inch)	WLL	Dimensions (mm)											Weight (kg)
				(t)	A	B	C	D1	E	F	L	M	N	P	
41.36.001500	10-13	$\frac{3}{8}'' - \frac{1}{2}''$	1,5	15	50	208	50	40	250	96	60	19	9	19	0,55
41.36.002000	14-16	$\frac{5}{8}''$	2	17,5	65	238	60	48	293	120	70	24	13	24	0,9
41.36.003000	17-18	$\frac{3}{4}''$	3	22	68	238	60	48	304	136	82	27	14	27	1,4
41.36.005000	19-25	$\frac{7}{8}'' - 1''$	5	24	84	301	75	60	371	154	92	31	23	31	3,5

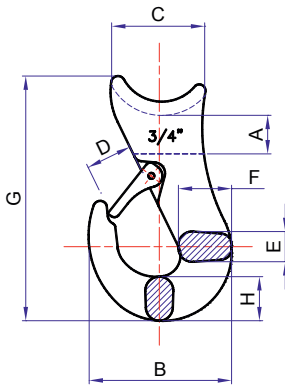

RAMSHORN SWIVEL HOOK (ROTATION UNDER LOAD, LIGHT DUTY), SERIE 145

Ref. nr.	Chain size	WLL	Dimensions (mm)											Weight (kg)
			(t)	A	B	C	D1	E	F	L	M	N	P	
41.35.005400	2,5V	5,4	15	50	208	50	40	250	96	60	19	9	19	3,5
41.35.008000	4-V	8	17,5	65	238	60	48	293	120	70	24	13	24	6,5
41.35.011500	4-V	11,5	22	68	238	60	48	304	136	82	27	14	27	8,5
41.35.016000	6-V	16	24	84	301	75	60	371	154	92	31	23	31	15
41.35.022000	8-V	22	29	107	337	85	67	445	191	108	38	35	38	24,5
41.35.031500	10-V	31,5	34	117	377	95	75	485	222	132	45	60	45	54

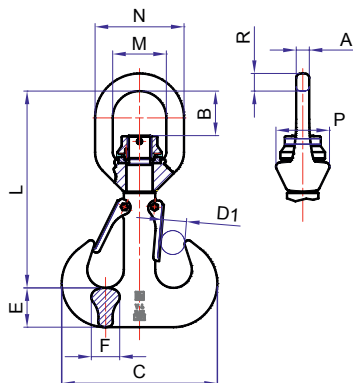

Lubrication nipple on demand (sizes 11.5 to 31.5)

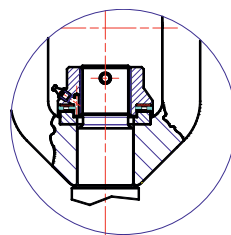

Shank self locking hooks

Shank hooks

SHANK SELF LOCKING HOOK, SERIE 104 (ACCORDING TO EN1677-3)

Ref. nr.	Chain size	WLL	Dimensions (mm)								Weight
			(t)	øA	B	D	E	F	G	øH	
41.40.06.0000	6-8	1,25	20	40	28	20	14	143	35	83	0,55
41.40.08.0000	7/8-8	2	20	42	33	25	20	181	45	114	0,9
41.40.10.0000	10-8	3,15	24	51	44	35	27	224	58	138	1,65
41.40.13.0000	13-8	5,3	28	64	54	40	31	277	71	173	3,1
41.40.16.0000	16-8	8	33	77	67	52	40	330	84	201	6,05

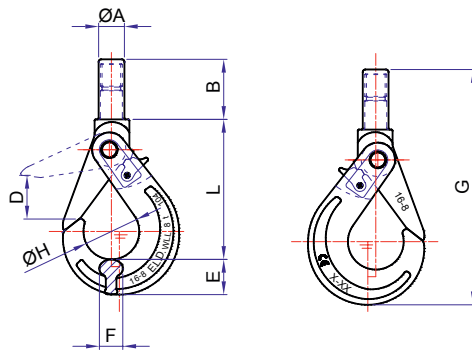

SHANK HOOK, SERIE 121 (ACCORDING TO EN1677-1)

Ref. nr.	Chain size	WLL	Dimensions (mm)										Weight
			(t)	A	B	C	D	D1	E	F	G	H	
41.41.06.0000	6-8	1,25	15	49	77	24	20	21	15	15	31	59	0,35
41.41.07.0000	7-8	1,6	17	57	82	26	22	23	18	18	34	67	0,55
41.41.08.0000	8-8	2,5	19	64	94	27	23	27	23	23	38	73	0,78
41.41.10.0000	10-8	3,2	23	69	106	32	27	31	23	24	42	82	1,1
41.41.13.0000	13-8	5,4	29	84	132	40	35	37	29	30	50	101	1,9
41.41.16.0000	16-8	8	36	92	165	51	43	49	37	37	62	126	3,8
41.41.19.0000	19-8	11,5	43	101	198	58	53	60	43	46	75	157	7,3
41.41.22.0000	22-8	16	48	112	222	66	58	67	52	57	84	167	10,5
41.41.26.0000	26-8	22	59	135	283	87	78	80	64	65	110	210	18,5
41.41.32.0000	32-8	31,5	85	244	339	97	87	94	80	80	120	250	39

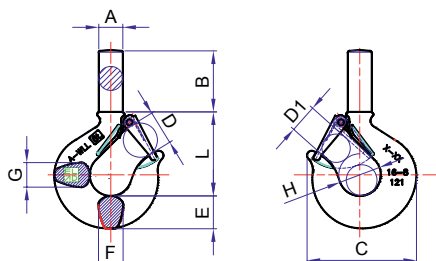

Machined shank self-locking hook

Machined shank hook

MACHINED SHANK SELF LOCKING HOOK, SERIE 504 (ACCORDING TO EN1677-3)

Ref. nr.	Chain size	WLL	Dimensions (mm)								Weight (kg)
			(t)	A	B	C	D	E	F	øH	
41.40.06.0000	6-8	1,25	M14	17	39	28	24	21	35	122	0,55
41.40.08.0000	7/8-8	2	M16	17	42	33	24	24	45	156	0,9
41.40.10.0000	10-8	3,2	M20	20	50	44	29	30	58	188	1,65
41.40.13.0000	13-8	5,4	M24	25	63	54	37	36	71	236	3,1
41.40.16.0000	16-8	8	M30	30	76	67	45	46	84	272	6,05

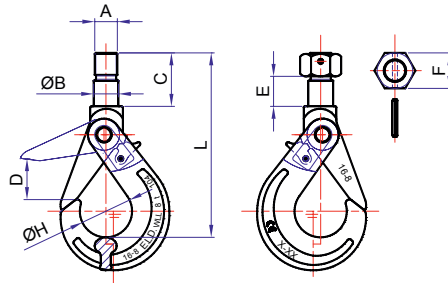

MACHINED SHANK HOOK, SERIE 521 (ACCORDING TO EN1677-1)

Ref. nr.	Chain size	WLL	Dimensions (mm)							Weight (kg)
			(t)	A	B	C	D	D1	E	
41.41.06.0000	6-8	1,25	M12	12	29	88	20	17.5	19	0,3
41.41.07.0000	7-8	1,6	M16	16	42	109	22	25	24	0,5
41.41.08.0000	8-8	2,5	M18	18	48	121	23	29	27	0,7
41.41.10.0000	10-8	3,2	M20	20	50	132	27	29	30	1
41.41.13.0000	13-8	5,4	M24	25	62	163	35	37	36	1,7
41.41.16.0000	16-8	8	M30	30	75	201	43	44.5	46	3,5
41.41.19.0000	19-8	11,5	M36x3	40	86	242	53	48.5	55	6,8
41.41.22.0000	22-8	16	M42x3	45	101	268	58	58	65	9,5
41.41.26.0000	26-8	22	M52x3	55	117	327	78	62.5	80	17
41.41.32.0000	32-8	31,5	M64x4	65	145	395	87	78	100	35

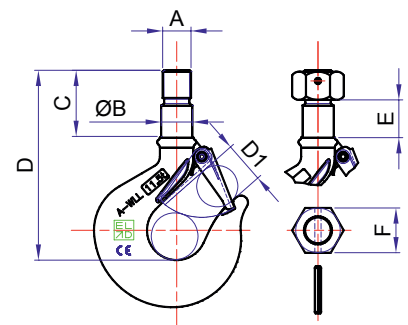

Lifting Point Swivel basket

LIFTING POINT, SERIE 115

Ref.Nr.	Size	WLL	Dimensions (mm)										Weight (kg)
			Fi	Lu	Ch	A	B	C	D	E	F	G	
41.73.08.0000	1	0,3	M8	14	17	30,5	31	40	10	49	8	30	0,24
41.73.10.0000		0,6	M10	17									0,25
41.73.12.0000		1	M12	21									0,26
41.73.16.0000	2	1,6	M16	27	22	45	42,5	56	16,5	72	13,3	45	0,91
41.73.20.0000		2,5	M20	30									0,95
41.73.24.0000	3	4	M24	36	32	60,5	59	85	25	113	20	60	2,91
41.73.30.0000		6,3	M30	45									3,03

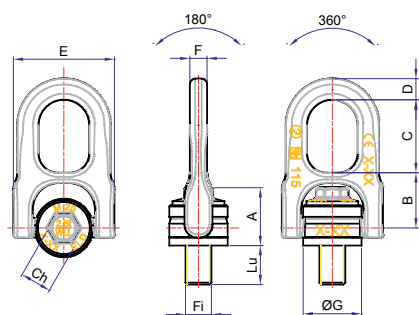

Sicherheitsfaktor 5:1

SWIVEL BASKET, SERIE 113

Ref. nr.	Chain size	WLL	Dimensions (mm)							Hole mm	Thread mm	Weight (kg)
			A	B	C	D	E	F	G			
41.44.06.0000	6-8	1,25	51	40	31	10	65,5	8	30	12,5	M12	0,75
41.44.08.0000	7/8-8	2	63	50	38	12,5	7	10	39	17,25	M16	0,9
41.44.10.0000	10-8	3,2	79	62	47	16	106	12,5	48	20,5	M20	1,3
41.44.13.0000	13-8	5,4	96	75	58	19	131	15	60	25,5	M24	1,6
41.44.16.0000	16-8	8	120	95	72	24	164	17,5	70	30,5	M30	3,5
41.44.19.0000	19-8	11,5	136	106	82	27	181	22	82	40,5	M36x3	6,5
41.44.22.0000	22-8	16	154	127	92	31	216	24	92	45,5	M42x3	8,5
41.44.26.0000	26-8	22	191	159	115	38	264	29	108	55,5	M52x3	15
41.44.32.0000	32-8	31,5	222	188	132	45	312	34	132	66	M64x4	24,5

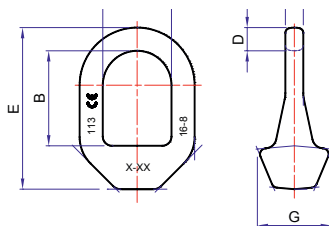

Weld-on bucket hooks

WELD-ON BUCKET HOOK, C SERIE

Ref. nr.	Size	WLL	Dimensions (mm)						Weight
			(t)	L	L1	H	B	øD1	
41.70.001000	C201	1	105	67	76	30	21	4	0,75
41.70.002000	C202	2	130	83	93	35	25	4	1,15
41.70.003000	C203	3	133	84	100	35	25	6	1,25
41.70.004000	C204	4	177	110	125	42	38	6	2,70
41.70.005000	C205	5	185	113	133	44	40	6	3,00
41.70.006000	C206	6	198	120	141	50	40	8	3,50
41.70.008000	C208	8	250	150	169	60	45	8	7,10
41.70.010000	C210	10	262	160	170	65	50	8	8,00
41.70.018000	C218	18	290	180	190	80	50	10	10,80

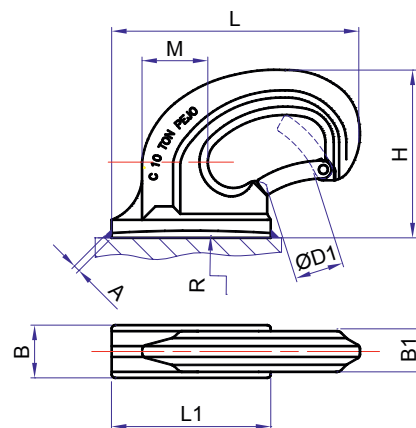

WELD-ON BUCKET HOOK, U SERIE

Ref. nr.	Size	WLL	Dimensions (mm)						Weight
			(t)	L	L1	H	B	øD1	
41.71.000500	U200	0,5	95	87	63	23	20	4	0,75
41.71.001000	U201	1	105	99	75	25	23	4	1,15
41.71.002000	U202	2	123	109	86	30	27	4	1,25
41.71.003000	U203	3	145	133	101	35	31	6	2,70
41.71.004000	U204	4	152	142	107	35	31	6	3,00
41.71.006000	U206	6	205	185	127	40	40	8	3,50
41.71.008000	U208	8	216	205	139	50	40	8	7,10

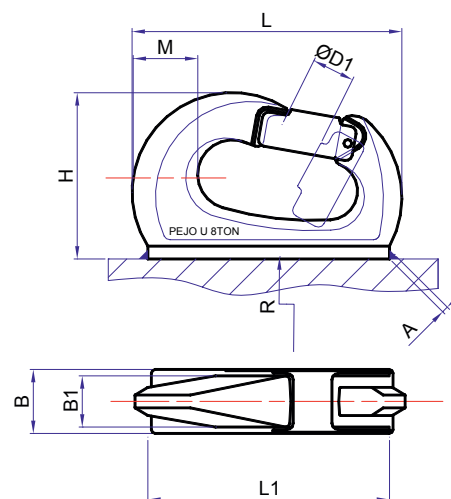

Load binders

RATCHET TYPE LOAD BINDER WITH HOOKS, FOLLOWING EN12195-3

Ref. nr.	Chain size	Lashing capacity	Min. breaking strength	Dimensions (mm)				Weight
		(kN)	(kN)	F	L	A1	A2	(kg)
30.08.08.001	8-8	40	80,4	355	118	588	752	4,9
30.08.10.001	10-8	63	126			602	766	5,3
30.08.13.001	13-8	100	212			710	870	7,4

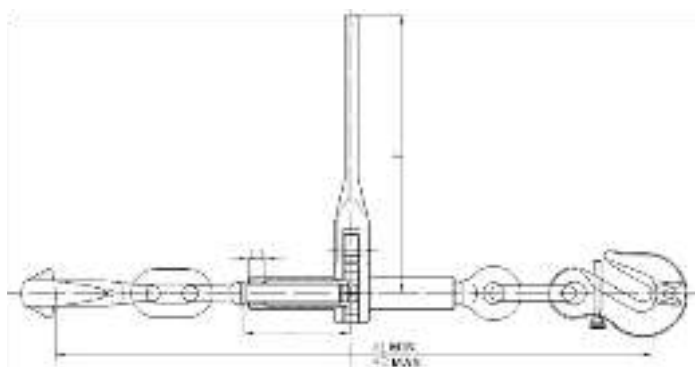

RATCHET TYPE LOAD BINDER WITHOUT HOOKS, FOLLOWING EN12195-3

Ref. nr.	Chain size	Lashing capacity	Min. breaking strength	Dimensions (mm)				Weight
		(kN)	(kN)	F	L	A1	A2	(kg)
30.08.08.000	8-8	40	80,4	355	118	340	520	4,2
30.08.10.000	10-8	63	126	355	118	340	520	4,3
30.08.13.000	13-8	100	212	355	118	362	562	4,6
30.08.16.000	16-8	160	322	355	118	362	562	5,6

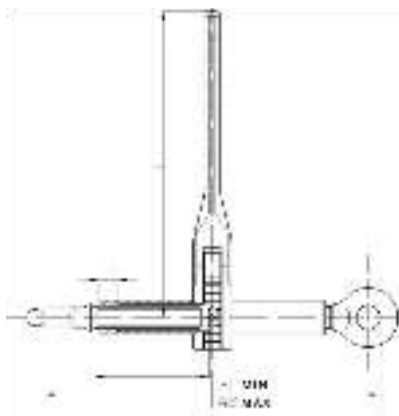

Tags for slings

TAG FOR LASHING CHAIN, WITHOUT RING, GALVANIZED

Ref. nr.	Type	Standard packing
41.99.000001	VDI2701 / EN 12195-3	1



TAGS FOR CHAIN SLINGS, WITHOUT RING, GALVANIZED

Ref. nr.	Type	Standard packing
41.99.000002	Einstrang	1
41.99.000003	Mehrstrang	1



Single leg

Multi leg

BackPage

TAGS FOR CHAIN SLINGS WITH WELDED RING 5X40, RED PAINTED RAL 3000 WITH "NEXT INSPECTION" MARKING

Ref. nr.	Type	Standard packing
41.99.000004	Einstrang	1
41.99.000005	Mehrstrang	1



Single leg

Multi leg

BackPage

NON-WELDED RING 5X40 FOR TAGS, GALVANIZED

Ref. nr.	Standard packing
41.99.000010	1



Chain assemblies

CHAIN ASSEMBLIES GRADE 80

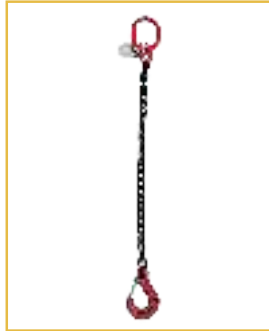

eye grab hook connected with ta serie 181 connecting link.
Grab hook available with or without safety pin









Clevis grab hook with 3 chain links
Grab hook available with or without safety pin

EXPLANATION ARTICLE STRUCTURE

42	08	A	4	01	250	A	B	2
Articlegroup chain assemblies	Nen diameter 6/7/8/10...	Grade type A=G80	Number of legs 1/2/3/4	Hook type	Working length in cm	Masterlink A= standard type	Shorting	Number of shorting possibilities 0/1/2/3/4
				<ul style="list-style-type: none"> 1 Clevis Hook type 179 2 Eye hook type 100 3 Eye hook type 101 4 Self locking clevis hook type 103 5 Self locking eye hook type 102 6 Eye grab hook type 183 7 Clevis grab hook type 184 8 Eye grab hook with pin type 183L 9 Clevis grab hook with pin type 184L 10 Self locking swivel hook (rotation under load) type 105 11 Self locking swivel hook (no rotation under load) type 106 12 Swivel hook (no rotation under load) type 167 13 Swivel hook (rotation under load) type 168 14 Connecting link type 181 15 Round sling connecting link type 191 16 Masterlink 		<ul style="list-style-type: none"> A = Without B = Eye grab hook type 183 C = Eye grab hook with pin type 183L D = Clevis grab hook type 184 E = Clevis grab hook with pin type 184L 		

Chain assemblies

CHAIN ASSEMBLIES GRADE 80

	WLL (kg)	Ø chain (mm)			179	100	101	103	102	167/168	105/106	
					Total length of only the fittings in mm incl. master link, connecting link(s) and hook(s)							
	$\beta = 90^\circ$		Inside width of standard master link (mm)									
	1120	6	110 x 60	-	221	-	278	252	303	312	358	
	2000	8	110 x 60	-	250	314	325	287	355	383	408	
	3150	10	135 x 75	-	307	391	390	353	437	441	497	
	5300	13	160 x 90	-	376	480	474	428	536	541	613	
	8000	16	180 x 100	-	432	590	575	496	642	654	725	
12500	20	260 x 140	-	567	740	-	-	-	-	-	-	
$\beta 0 - 45^\circ$		$\beta 45 - 60^\circ$										
	1600	1120	6	110 x 60	-	221	-	278	252	303	358	
	2800	2000	8	135 x 75	-	275	339	350	312	380	408	
	4250	3150	10	160 x 90	-	332	416	415	378	462	466	
	7500	5300	13	180 x 100	-	396	500	494	448	556	561	
	11200	8000	16	200 x 110	-	452	610	595	516	662	674	
	17000	12500	20	300 x 160	-	607	780	-	-	-	-	
$\beta 0 - 45^\circ$		$\beta 45 - 60^\circ$										
	2360	1700	6	-	135 x 75	300	-	357	331	382	391	437
	4250	3000	8	-	160 x 90	370	434	445	407	475	503	528
	6700	4750	10	-	180 x 100	437	521	520	483	567	571	627
	11200	8000	13	-	200 x 110	531	635	629	583	691	696	768
	17000	11800	16	-	260 x 140	652	810	795	716	862	874	945
	26500	19000	20	-	350 x 190	807	980	-	-	-	-	-
$\beta 0 - 45^\circ$		$\beta 45 - 60^\circ$										
	2360	1700	6	-	135 x 75	300	-	357	331	382	391	437
	4250	3000	8	-	160 x 90	370	434	445	407	475	503	528
	6700	4750	10	-	180 x 100	437	521	520	483	567	571	627
	11200	8000	13	-	200 x 110	531	635	629	583	691	696	768
	17000	11800	16	-	260 x 140	652	810	795	716	862	874	945
	26500	19000	20	-	350 x 190	807	980	-	-	-	-	-

Round sling assemblies



TLX Round sling with on each leg a PES-TLX sleeve



TLX Round sling with on each leg a PVC protection sleeve

EXPLANATION ARTICLE STRUCTURE

43	02	C	4	03	250	A	A	0
Article group Round sling assemblies	WLL of the individual Round sling: 1/2/3/4/5T...	Quality ↓ C=Round sling Techlon (TLX)	Number of legs: 1/2/3/4	Hook type ↓ 2 Eye hook, 100 Serie 3 Eye hook, 101 Serie 5 Self locking eye hook, 102 Serie	Working length in cm	Master link A = Standard	Sleeve type ↓ C = Techlon (TLX) D = PVC	Free

ROUND SLING ASSEMBLIES

	WLL (kg)	Type of Round sling	Type of Master link		100			101			102		
	$\beta = 90^\circ$		Inside width of standard master link (mm)		Total length of only the fittings in mm incl. master link, connecting links and hook(s)								
	1000	1000 kg	110 x 60	-	-	327	369	-	327	369	-	327	369
	2000	2000 kg	110 x 60	-	328	339	369	413	412	459	506	500	562
	3000	3000 kg	135 x 75	-	413	412	459	506	500	562	515	500	562
	4000	4000 kg	160 x 90	-	506	500	562	515	500	562			
	$\beta 0 - 45^\circ$ $\beta 45 - 60^\circ$												
	1400	1000 kg	110 x 60	-	-	327	369	-	327	369	-	327	369
	2800	2000 kg	135 x 75	-	353	364	369	438	437	484	526	520	582
	4200	3000 kg	160 x 90	-	438	437	484	526	520	582	535	520	582
	5600	4000 kg	180 x 100	-	526	520	582	535	520	582			
	$\beta 0 - 45^\circ$ $\beta 45 - 60^\circ$												
	2100	1000 kg	-	135 x 75	-	406	448	-	406	448	-	406	448
	4200	2000 kg	-	160 x 90	448	459	489	543	542	589	661	655	717
	6300	3000 kg	-	180 x 100	543	542	589	661	655	717	670	655	717
	8400	4000 kg	-	200 x 110	661	655	717	670	655	717			
	$\beta 0 - 45^\circ$ $\beta 45 - 60^\circ$												
	2100	1000 kg	-	135 x 75	-	406	448	-	406	448	-	406	448
	4200	2000 kg	-	160 x 90	448	459	489	543	542	589	661	655	717
	6300	3000 kg	-	180 x 100	543	542	589	661	655	717	670	655	717
	8400	4000 kg	-	200 x 110	661	655	717	670	655	717			
10500	5000 kg	-	260 x 140	670	655	717							

Lashing chains

LASHING CHAINS ACCORDING THE EN 12195-3



Lashing chain 1-part

1 x Eye-eye ratchet, one side a clevis grab hook and clevis hook with 5 chain links (see detail picture). On the other side only a clevis hook
Total standard length 3 meter

Detail grab hook with safety pin



Lashing chain 2-part

1 x separate Ratchet with grab hooks
1 lashing chain both sides with clevis hook

EXPLANATION ARTICLE STRUCTURE

44	08	A	2	01	350	A	B	0
Article group	Chain size	Grade type	1 or 2-part	Hook type	Working length	Ratchet type	Shorting	Free
				<ul style="list-style-type: none"> 1 Clevis Hook type 179 2 Eye hook type 100 3 Eye hook type 101 8 Eye grab hook with pin type 183L 9 Clevis grab hook with pin type 184L 		<ul style="list-style-type: none"> A= Ratchet with grab hooks B= Eye-eye ratchet C= Without ratchet 	<ul style="list-style-type: none"> A = Without C = Eye grabhook with pin type 183L E = Clevis grab hook with pin type 184L 	

LASHING CHAIN GRADE 80

		Ø Chain (mm)	LC (kN)
	Lashing chain 2-part		
	1 x Ratchet grab hook /grab hook	8	40
	1 x lashing chain both sides Clevis hook L=3mr	10	63
	Lashing chain 1-part		
	1 x Eye-eye ratchet, one side a clevis grab hook and clevis hook with 5 chain links	8	40
	On the other side only a clevis hook	10	63
	Total standard length 3 meter	13	100
		16	160

Spare parts

SAFETY LATCH KIT WELD-ON BUCKET HOOK, TYPE C

Ref. nr.	For hooks	Standard packing	Dimensions (mm)			
			A	B	C	D
41.80.000060	C201	1	38	32,5	20	5
41.80.000061	C202-C203	1	43	37	25,5	5
41.80.000062	C204-C205-C206	1	62	55	34	6
41.80.000063	C208-C210-C218	1	84	74	44	8

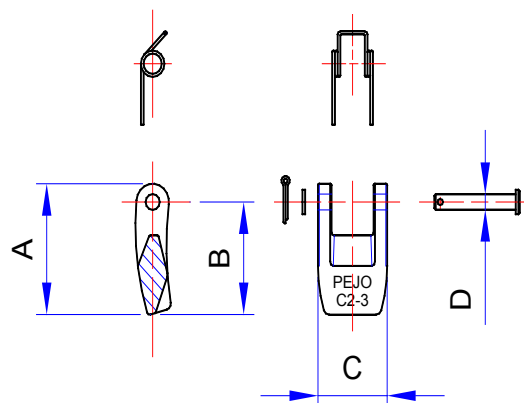

SAFETY LATCH KIT WELD-ON BUCKET HOOK, TYPE U

Ref. nr.	For hooks	Standard packing	Dimensions (mm)			
			A	B	C	D
41.80.000070	U200-U201	1	46,5	41,5	20	5
41.80.000071	U202	1	57	50	26	6
41.80.000072	U203-U204	1	71,5	63	35	8
41.80.000073	U206-U208	1	86	74	42	10

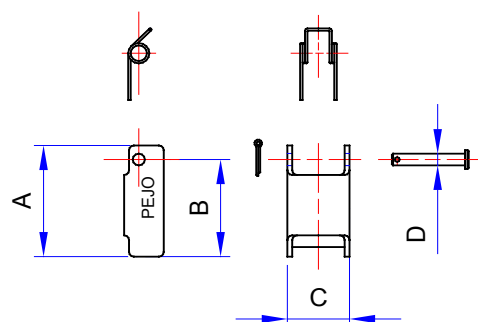

SAFETY LATCH KIT SLIDING CHOKER HOOK, SERIES 112

Ref. nr.	For hooks	Standard packing	Dimensions (mm)		
			A	B	C
41.80.000020	112 3/8"-1/2"	1	47	39	24
41.80.000021	112 5/8"	1	52	40	28
41.80.000022	112 3/4"	1	52	40	32
41.80.000023	112 7/8"-1"	1	62	41	35

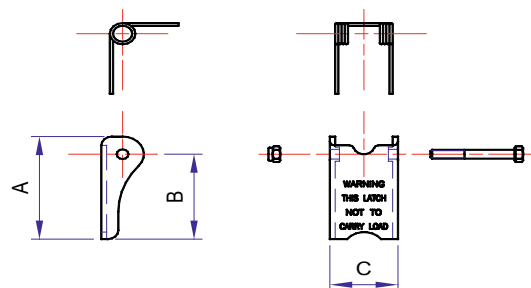

Spare parts

SAFETY LATCH KIT FOR HOOKS, SERIES 101, 121, 167, 168, 169, 521

Ref. nr.	For hooks	Marking	Standard packing	Dimensions (mm)			
				A	B	C	D
41.80.00000	6-8	D1	1	39,5	32,5	17	4
41.80.00001	7-8	D2	1	43,5	35,5	23	4
41.80.00002	8-8 & 10-8	D3	1	49	41	25	4
41.80.00003	13-8	D4	1	61,5	51,5	29	5
41.80.00004	16-8	D5	1	77,5	67,5	35	5
41.80.00005	19-8	D6	1	87	76	37	6
41.80.00006	22-8	D7	1	96	85,5	49	6
41.80.00007	26-8	D8	1	131	116	54	6
41.80.00008	32-8	D9	1	152,5	135	64	8

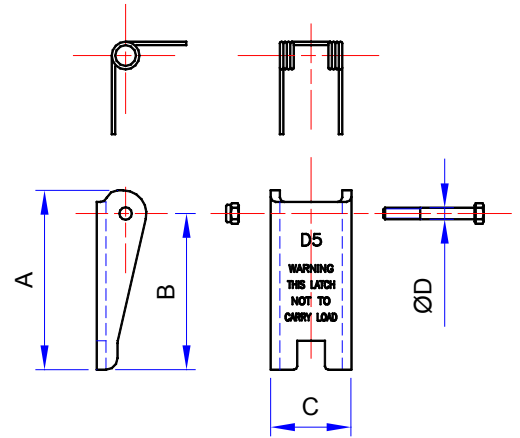

SAFETY LATCH KIT FOR HOOKS, SERIES 179

Ref. nr.	For hooks	Standard packing	Dimensions (mm)			
			A	B	C	D
41.80.000040	6-8	1	41,5	36	17	4
41.80.000041	7/8-8	1	52	44,5	22	4
41.80.000042	10-8	1	63,5	55	28	4
41.80.000043	13-8	1	79,5	69	30	5
41.80.000044	16-8	1	92	79,5	36	6
41.80.000045	20-8	1	111	96	45	8

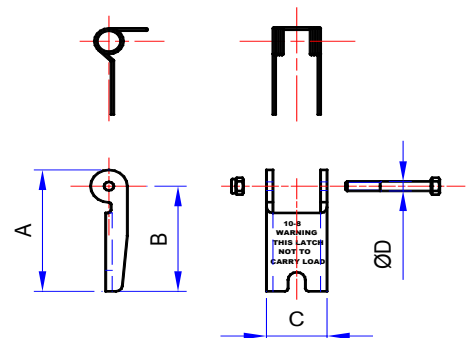

SPARE PART KIT FOR CLEVIS HOOKS, SERIES 103, 179, 184

Ref. nr.	For hooks	Standard packing	Dimensions (mm)		
			øF	G	ød
41.80.000030	6-8	1	8	20	2,5
41.80.000031	7/8-8	1	10	28	3
41.80.000032	10-8	1	12,5	35	3
41.80.000033	13-8	1	16	38	4
41.80.000034	16-8	1	20	50	5
41.80.000035	20-8	1	24	60	5

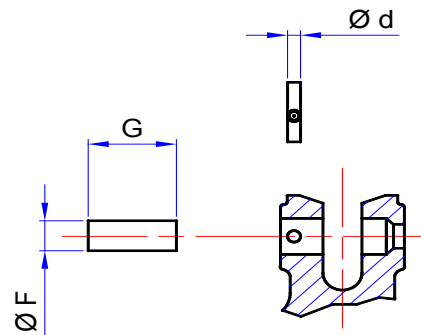

Spare parts

SPARE PART KIT FOR SAFETY HOOKS, SERIES 102, 103, 104, 105, 106, 504

Ref. nr.	For hooks	Standard packing
41.80.000045	6-8	1
41.80.000046	7/8-8	1
41.80.000047	10-8	1
41.80.000048	13-8	1
41.80.000049	16-8	1

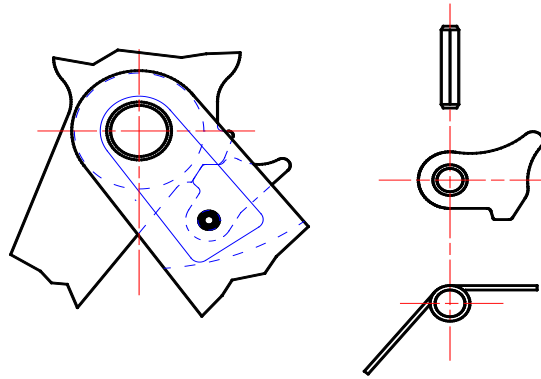

SAFETY PIN KIT FOR HOOKS, SERIES 183L, 184L

Ref. nr.	For hooks	Standard packing	Dimensions (mm)	
			øA	B
41.80.000081	7/8-8	1	5	41
41.80.000082	10-8	1	6	52,5
41.80.000083	13-8	1	6	63
41.80.000084	16-8	1	6	74
41.80.000085	20-8	1	8	92

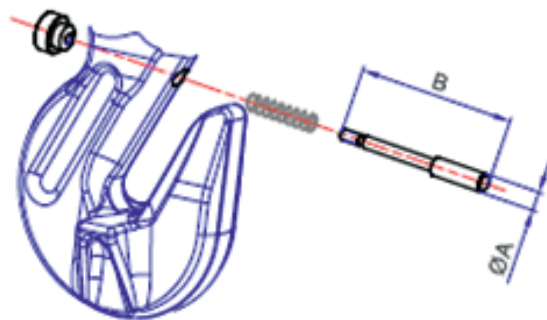

SAFETY PIN KIT FOR LOAD BINDER HOOKS

Ref. nr.	For load binder	Standard packing
30.00.08P	8-8	1
30.00.10P	10-8	1
30.00.13P	13-8	1



GENERAL INSTRUCTIONS FOR USE

1. General notices

With reference to the contents of these instructions for use, ELD Division of Feat Group SpA and Technotex/Unitex refuses any responsibility in the event of:

- The use of accessories in a manner contrary to national safety and accident prevention legislation.
- Incorrect choice or predisposition of the lifting apparatus with which they shall be connected.
- Failure to observe correctly these instructions for use.
- Unauthorised modifications to the accessories.
- Improper use or lack of ordinary maintenance
- Use combined with non-conforming accessories

2. Criteria of choice and life of accessory

ELD products can be used as indicated in the following table:

Criterion of choice		
Series	Sling accessories	Lifting accessories
101	X	X
102	X	-
103	X	-
105	X	X
106	X	X
112	X	-
117	X	X
118-119	X	X
122-123	-	X
145	X	X
151	X	-
167	X	X
168-169	X	X
179	X	-
181	X	-
183	X	-
184	X	-
302	X	-

The parameters which must be carefully considered in choosing are as follows

A. Maximum work load (WLL or lifting capacity)

- If the hook is used as a sling accessory, the maximum work load depends on the grade and configuration
- If the hook is used as a lifting accessory, the maximum work load is indicated on the part (WLL)

For sling accessories with single arm this corresponds to the values indicated in the table below:

Maximum work load										
WLL	Diameter of grade 8 chain 8 (mm)									
	6	7	8	10	13	16	20	22	26	32
t	1,12	1,5	2	3,15	5,3	8	12,5	15	21,2	31,5

B. The grade

The grade must be determined in accordance with the compatibility with the component to which it will be connected. Each grade is identified with a number and/or letter as indicated in the table below.

Grade	
Letter	Number
C (carbon steel)	4
- (lightly alloyed steel)	6
A (alloyed steel)	8

C. Temperature of use:

The temperature of use shall be included in the range indicated in the table below, bearing in mind the variation of the lifting capacity on the basis of the temperature

Climatic conditions of use					
Grade		Load expressed as a % of maximum load			
		Temperature, t., °C			
		-40 < t ≤ 200	-20 < t ≤ 200	200 < t ≤ 300	300 < t ≤ 400
C	4		100	90	75
-	6		100	90	75
A	8	100		90	75

D. Life span and frequency of use:

The life span of this accessory is anticipated as being for 20,000 operational cycles at full load.

3. Marking

Marking and/or nameplates are set out in an indelible manner concerning the anticipated use as indicated below.

GENERAL INSTRUCTIONS FOR USE

Marking		
Relative indication	Sling accessories	Lifting accessories
Identification of manufacturer	X	X
Identification of product (excluding series 112,122,123)	X	X
Identification of production lot	X	X
Diameter of chain in inches (only series 102,103,179,181,183,184)	X	-
Diameter of rope in inches (only series 112)	X	-
Maximum work load (lifting capacity) (einschließlich Serie 112)	-	X
Angabe Güteklasse mit der Nummer oder Buchstaben (excluding series 122,123)	X	X
CE Logo	X	X

ATTENTION ! You are advised to read the instructions for use specific to each product on our website

The following loads cannot be moved:

- those whose weight exceeds the lifting capacity of the accessory.
- those whose surface temperature exceeds that admissible.
- those whose surface is not sufficiently resistant to the pressure exerted by the action of pick-up.
- those classified as dangerous (e.g.: inflammable or explosive materials, etc.).
- those which could change their static configuration and/or their centre of gravity, or their physical-chemical state.
- those immersed in acid or exposed to acidic vapours

5. Restrictions on installation

If used with chains, sling accessories must only be used in connection with chains of average tolerance for sling chain conforming to EN 818-2 with the help of a connecting link. For different uses, contact the manufacturer.

If used with ropes, sling accessories must only be used in connection with metal ropes suitable for the purpose, considering the lifting capacity and dimensions.

Lifting accessory can only be used if installed in connection with pick-up or hook-up units suitable for the purpose, bearing in mind the lifting capacity and dimensions; the suspension or pick-up of the accessory must be carried out in such a way as to ensure its mobility around a supporting point thereby constituting an articulated hinge; and no force, interference or rigid connection must exist between the suspension element and the hook or hook-up point with the lifting pick-up unit.

6. Preliminary checks

Before starting up and/or assembling:

- check the accessory to ensure especially that there are no cuts, bends, incisions, abrasions, cracks, corrosion, or parts missing such as, for example, the load-bearing pin and the elastic blocking pin.
- check for the presence of markings.

7. Installation, assembly instructions

See the instructions for use for each product available on our website.

8. Suitability for use

The accessory has been subjected to testing by the manufacturer, in order to assess its functional response and performance. The certificate, which is supplied with the accessory, attests to a successful outcome of the tests carried out.

The user must, in every case and before carrying out operations, check this functional response and performance of the accessory when installed in order to confirm the suitability of the whole installation for use.

9. Using the accessory – pick-up and manoeuvre

Use, load pick-up and manoeuvre with the accessory must be made with great attention, delicately and without jerking. The possible safety latch opens manually by applying pressure to the device itself and it closes automatically as a result of the strength of the spring. This closing device does not hold the load under tension, that is the pick-up element is slack, precisely to permit unhooking. For this reason, always check that it is the hook which supports the load.

ATTENTION ! The latch must never support the load

Do not introduce more than two arms into our products and the maximum angle compared to the vertical must never exceed those indicated below.

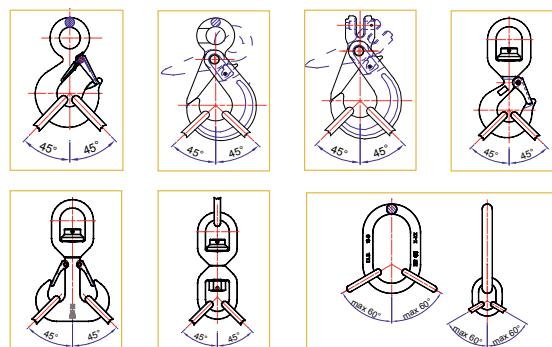

GENERAL INSTRUCTIONS FOR USE

For products where hook rotation is possible, take care that it is permitted when loaded

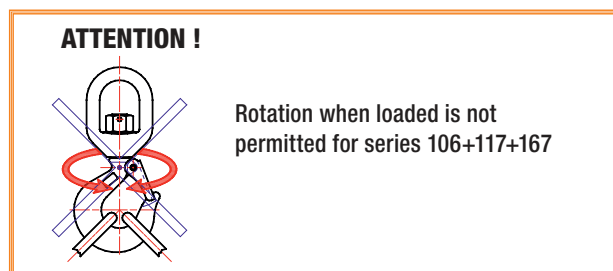

10. Restrictions on use.

Using the accessory for purposes which are not anticipated, its improper use, its use in dangerous conditions and the failure to carry out maintenance can all lead to situations of serious danger to persons thus exposed as well as to the work setting, and can also affect the functioning and safety of the accessory negatively. The actions indicated below, which obviously do not cover all possible examples of 'bad use' of the accessory, are however those which could reasonably be predicted. So:

- NEVER use the accessory to lift and move persons, animals and things different from those which the hook is designed to be used.
- NEVER raise loads with the point of the hook.
- NEVER raise or move loads in flight (i.e. aircraft) nor use the accessory to drag bound loads.
- NEVER operate in areas where the use of non-flammable/spark-proof components is required or in the presence of strong electromagnetic fields.
- NEVER weld metallic elements to the accessory, add welded elements or use it as a weight for welding purposes.

11. Inspection and maintenance.

This includes operations of maintenance, carried out by personnel who have been trained for the purpose, concerning checks during use and possible actions as anticipated in the 'Table of maintenance and check-up operations'.

The accessory must be subjected to the following checks:
Records of these checks must be kept safe

- visual: check for the presence of surface defects such as cracks, incisions, cuts or fissures, abrasions.
- functional: check the accessory and the connecting link can move freely, the latch carries out the function of unhooking, and especially the spring keeps the blocking mechanism functioning.

- dimensional control: take and record the critical dimensions as indicate in the specific instruction for use available in our website before the first putting into service.
- deformation: check that the accessory does not lose its shape by measuring critical dimensions as indicated in the specific instruction for use available in our website
- wear and tear: check that points of contact are not worn out by measuring critical dimensions as indicated in the specific instruction for use available in our website.
- lubrication: apply a grease film on moving parts within the accessory.
- state of preservation: check for the presence of excessive oxidisation and corrosion, above all in cases where it is used in the open air; check for the presence of cracks with suitable methods (e.g. penetrating liquids) .

12. Demolition and scrapping of the accessory

If the accessory should turn out to be deformed, worn out or at the end of its life span as indicated by the manufacturer, and therefore no longer usable, it must be demolished and scrapped.

Table of maintenance and check-up operations				
Description of check-up	Ordinary		Periodical	
	Day	Week	Month	Year
Visual	X			
Functional	X			
Deformation		X		
Wear and tear and lubrication			X	
State of preservation				X

Replace the accessory when it is permanently deformed or there are section reductions as indicated in the instructions for use for each product which you can find on our website.

Load Capacity DIN 15402 and DIN 15401 hooks

LOAD CAPACITY ACCORDING UNI 9465 - DIN 15400



class	Driving Gear Group									
M					1Bm M3	1Am M4	2m M5	3m M6	4m M7	5m M8
P				1Bm M3	1Am M4	2m M5	3m M6	4m M7	5m M8	
S			1Bm M3	1Am M4	2m M5	3m M6	4m M7	5m M8		
T		1Bm M3	1Am M4	2m M5	3m M6	4m M7				
V	1Bm M3	1Am M4	2m M5	3m M6	4m M7					

Hook	Load Capacity in Kg									
012	630	500	400	320	250	200	160	125	100	
020	1.000	800	630	500	400	320	250	200	160	125
025	1.250	1.000	800	630	500	400	320	250	200	160
04	2.000	1.600	1.250	100	800	630	500	400	320	250
05	2.500	2.000	1.600	1.250	1.000	800	630	500	400	320
08	4.000	3.200	2.500	2.000	1.600	1.250	1.000	800	630	500
1	5.000	4.000	3.200	2.500	2.000	1.600	1.250	1.000	800	630
1,6	8.000	6.300	5.000	4.000	3.200	2.500	2.000	1.600	1.250	1.000
2,5	12.500	10.000	8.000	6.300	5.000	4.000	3.200	2.500	2.000	1.600
4	20.000	16.000	12.500	10.000	8.000	6.300	5.000	4.000	3.200	2.500
5	25.000	20.000	16.000	12.500	10.000	8.000	6.300	5.000	4.000	3.200
6	32.000	25.000	20.000	16.000	12.500	10.000	8.000	6.300	5.000	4.000
8	40.000	32.000	25.000	20.000	16.000	12.500	10.000	8.000	6.300	5.000
0	50.000	40.000	32.000	25.000	20.000	16.000	12.500	10.000	8.000	6.300
12	63.000	50.000	40.000	32.000	25.000	20.000	16.000	12.500	10.000	8.000
16	80.000	63.000	50.000	40.000	32.000	25.000	20.000	16.000	12.500	10.000
20	100.000	80.000	63.000	50.000	40.000	32.000	25.000	20.000	16.000	12.500
25	125.000	100.000	80.000	63.000	50.000	40.000	32.000	25.000	20.000	16.000
32	160.000	125.000	100.000	80.000	63.000	50.000	40.000	32.000	25.000	20.000
40	200.000	160.000	125.000	100.000	80.000	63.000	50.000	40.000	32.000	25.000
50	250.000	200.000	160.000	125.000	100.000	80.000	63.000	50.000	40.000	32.000
63	320.000	250.000	200.000	160.000	125.000	100.000	80.000	63.000	50.000	40.000
80	400.000	320.000	250.000	200.000	160.000	125.000	100.000	80.000	63.000	50.000
100	500.000	400.000	320.000	250.000	200.000	160.000	125.000	100.000	80.000	63.000
125		500.000	400.000	320.000	250.000	200.000	160.000	125.000	100.000	80.000

This table establishes a general classification of cranes based on the number of operating cycles to be carried out during the expected life of the crane and a load spectrum factor which represents a nominal state of loading. Classification considers only the operating conditions which are independent of the type of crane and the way it is driven.

Products overview DIN hooks and blocks



DIN15402



DIN15401



OVERHEAD CRANE BLOCKS



SPECIAL BLOCKS



SPECIAL BLOCKS

Disclaimer: *The information contained in this brochure has been prepared for promotional purposes and should only be used for guidance. This information should not be considered as a guarantee under any circumstances. Technotex/unitex makes no warranty, expressed or implied, and assumes no legal liability or responsibility for the accuracy, completeness or usefulness of any information contained herein. If additional information is required, please contact your local Technotex sales representative.*

