

ATOM

Product Image



Project Data

Project: _____
 Location: _____
 Date: _____
 Remarks: _____
 Approve by: _____

Application Type: INGROUND UPLIGHTER
 Product Name: ATOM - CC Ground/ Concrete Wall Recess
 Ordering Code: 9090-7-2-525-91
 Lamp Type: LED
 Socket: N/A
 Watt: 2 W(700mA)
 Lumen: 240 lm
 Beam: 42°
 Kelvin: 2700 K

Dimension

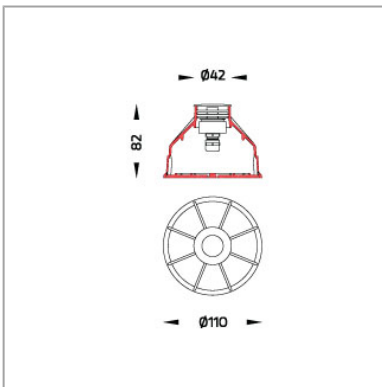

Light Distribution

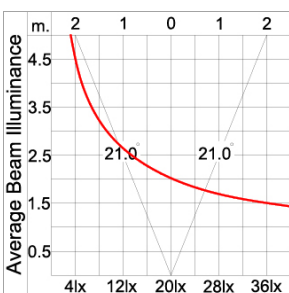
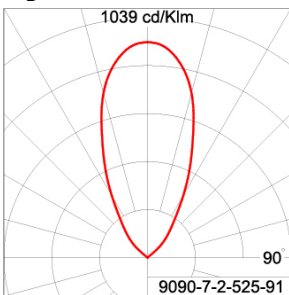

*Due to the constancy of product development,
 we reserve the right to alter all specification
 without prior notice.

ATOM

Specification

IEC Standard	IEC 60598-1 General Requirement IEC 60598-2-13 Ground Recessed Luminaires
Protection	IP68 Class III
IK Rating	Protection against mechanical impact IK10 on body and IK07 on optical part.
Luminaires Body Housing	Supreme corrosion proof Under Water grade Stainless Steel. Recessed housing made of GFR polymer. Small vehicles can drive over the luminaire at low speed (maximum 20kgm/hour). Withstand maximum load 500 kgs.
Diffuser	Impact resistant safety tempered glass cover. Able to withstand the temperature up to 250°C.
Lens	Molded PC lens from renowned manufacturers in various light distribution patterns.
Gasket	Post-cured treated silicone gasket. Temperature and weather resistant. Working temperature -40°C to +200°C.
External screws	External screws are in stainless steel with protection grease.
Cable Entry	Cable entry protected by M12 cable gland. To be used with HO5RN-F/ HO7RN-F cable with 4-7mm. diameter
LED	High efficiency LED module utilized chips from world renowned manufacturer. Assembled on MCPCB and mounted on to heat conductive material. The whole systems tested to be operated under maximum ambient environment up to +40°C.
Driver	Driver is not included and has to be ordered separately.
Internal wire	Tinned copper conductor with silicone insulated internal wire. IMQ approved. Working temperature -40°C to +180°C
Pre-wired cable	Pre-wired with 2x0.5sqmm. FEP + Rubber PCP cable. IMQ approved. Equipped with anti-humidity kit.
Caution	Installation work has to be carried on according to the enclosed installation manual. The water drainage system must be tested to ensure that it is sufficiency and efficiency.

ATOM

Accessories



Ordering Code: 9-0906-00

Gel-Filled IP68 connector.
Cable Diameter 4.8 - 6mm.

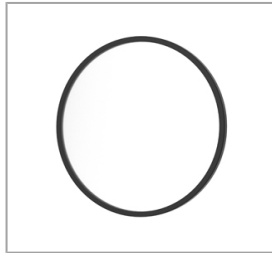

Ordering Code: 0288-0-9-
000-00
Softening Filter

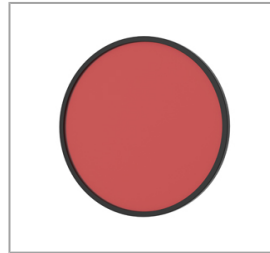

Ordering Code: 0289-0-9-
000-81
Color Filter Red

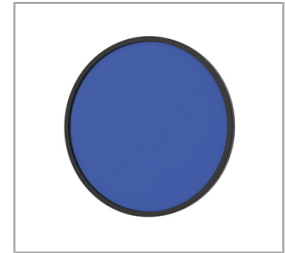

Ordering Code: 0289-0-9-
000-83
Color Filter Blue

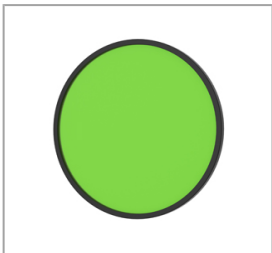

Ordering Code: 0289-0-9-
000-84
Color Filter Green



Ordering Code: Please contact
Sales Representative
LED Constant Current Driver



Ordering Code: Please contact
Sales Representative
LED Converter



Ordering Code: 9-0907-00

IP68 "Series-Wiring LED"
Distribution Box for 1-3
Luminaires.



Ordering Code: 0454-0-9-
000-00

LED Constant Current Driver
700mA 20W. In IP67 GFR
Polymer Box (DALI)
Including IP68 Series-Wiring
LED Distribution Box for 2-3
Luminaires