

อุปกรณ์ มือจับ

HANDLES



อุปกรณ์มือจับและปุ่มจับเฟอร์นิเจอร์ (Handles & Knobs)

อะไหล่เฟอร์นิเจอร์สำหรับติดตั้งเป็นมือจับประตู ปุ่มจับบานตู้ต่างๆ เพื่อให้สะดวกต่อการเปิด-ปิด มีให้เลือกหลายรูปแบบ ทั้งลวดลาย สีส้นและหลากหลายวัสดุ และ ดีไซน์ที่แตกต่างกันออกไป อีกทั้งยังเพิ่มความสวยหรูตราไว้กับเฟอร์นิเจอร์ได้ทุกสไตล์ ทั้งบานตู้ และ บานประตู



A

มือจับตัวซีเหล็กชุบโครเมียม

STEEL IN CHROME HANDLES (PA)

Material : Steel
Dia : 8 mm.

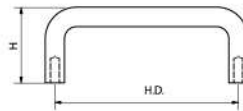

ITEM NO	HOLE DISTANCE	HEIGHT(H)	FINISHING	PACKING
C8-30	3 inch.	30 mm.	Chromium	
C8-40	4 inch.	31 mm.	Chromium	
C8-64	64 mm.	31 mm.	Chromium	
C8-96	96 mm.	30 mm.	Chromium	

STAINLESS

มือจับรูปโค้งสแตนเลส

STAINLESS HANDLES (IM)

Material : Stainless Steel
Dia : 8 mm.

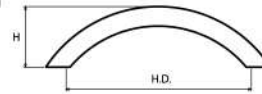

ITEM NO	HOLE DISTANCE	HEIGHT(H)	FINISHING	PACKING
TCS-8-64	64 mm.	26 mm.	Stainless	
TCS-8-96	96 mm.	29 mm.	Stainless	
TCS-8-128	128 mm.	31 mm.	Stainless	
TCS-8-160	160 mm.	34 mm.	Stainless	

Dia : 10 mm.



ITEM NO	HOLE DISTANCE	HEIGHT(H)	FINISHING	PACKING
TCS-10-64	64 mm.	26 mm.	Stainless	
TCS-10-96	96 mm.	29 mm.	Stainless	
TCS-10-128	128 mm.	31 mm.	Stainless	
TCS-10-160	160 mm.	34 mm.	Stainless	

STAINLESS

มือจับกระบองสแตนเลส

STAINLESS HANDLES (IM)

Material : Stainless Steel
Dia : 10 mm.

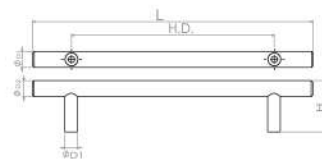

ITEM NO	HOLE DISTANCE	(H)	L	D1	D2	PACKING
TSSC-10-96	96 mm.	34 mm.	146 mm.	8 mm.	10 mm.	
TSSC-10-128	128 mm.	34 mm.	177 mm.	8 mm.	10 mm.	
TSSC-10-160	160 mm.	34 mm.	210 mm.	8 mm.	10 mm.	
TSSC-10-192	192 mm.	34 mm.	250 mm.	8 mm.	10 mm.	
TSSC-10-224	224 mm.	34 mm.	272 mm.	8 mm.	10 mm.	

Dia : 12 mm.



ITEM NO	HOLE DISTANCE	(H)	L	D1	D2	PACKING
TSSC-12-96	96 mm.	34 mm.	146 mm.	10 mm.	12 mm.	
TSSC-12-128	128 mm.	34 mm.	177 mm.	10 mm.	12 mm.	
TSSC-12-160	160 mm.	34 mm.	210 mm.	10 mm.	12 mm.	
TSSC-12-192	192 mm.	34 mm.	240 mm.	10 mm.	12 mm.	
TSSC-12-224	224 mm.	34 mm.	272 mm.	10 mm.	12 mm.	

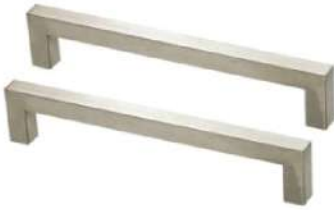

STAINLESS

มือจับสแตนเลส
STAINLESS HANDLES (IM)

Material : Stainless Steel

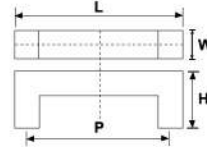

ITEM NO	SIZE (WxLxH)	HOLE DISTANCE	FINISHING	PACKING
MT-909-96	12x108x32 mm.	96 mm.	Stainless	
MT-909-128	12x140x32 mm.	128 mm.	Stainless	
MT-909-160	12x172x32 mm.	160 mm.	Stainless	
MT-909-192	12x192x32 mm.	192 mm.	Stainless	
MT-909-224	12x236x32 mm.	224 mm.	Stainless	



STAINLESS

มือจับสแตนเลส
STAINLESS HANDLES (IM)

Material : Stainless Steel

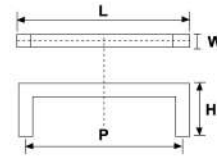

ITEM NO	SIZE (WxLxH)	HOLE DISTANCE	FINISHING	PACKING
MT-910-96	10x106x32 mm.	96 mm.	Stainless	
MT-910-128	10x138x32 mm.	128 mm.	Stainless	
MT-910-160	10x170x32 mm.	160 mm.	Stainless	



STAINLESS

มือจับสแตนเลส
STAINLESS HANDLES (IM)

Material : Stainless Steel

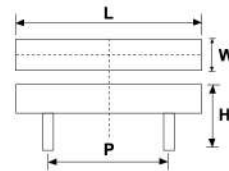

ITEM NO	SIZE (WxLxH)	HOLE DISTANCE	FINISHING	PACKING
MT-924-96	12x156x35 mm.	96 mm.	Stainless	
MT-924-128	12x188x35 mm.	128 mm.	Stainless	
MT-924-160	12x220x35 mm.	160 mm.	Stainless	
MT-924-192	12x252x35 mm.	192 mm.	Stainless	



STAINLESS

มือจับสแตนเลส รุ่นด้ามตรง
STAINLESS HANDLES (PA)

Material : Stainless Steel

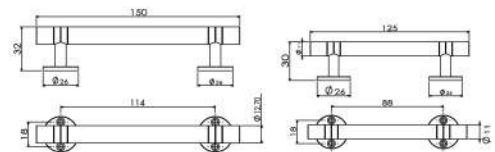

ITEM NO	L	FINISHING	PACKING
HDSS-125	125 mm.	Stainless	
HDSS-150	150 mm.	Stainless	

A

STAINLESS

มือจับสแตนเลส รุ่นลายหลุยส์
STAINLESS HANDLES (PA)

Material : Stainless Steel

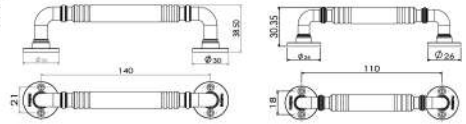

ITEM NO	L	FINISHING	PACKING
HDSS-135	135 mm.	Stainless	
HDSS-175	175 mm.	Stainless	

STAINLESS

มือจับสแตนเลส รุ่นลายบัว
STAINLESS HANDLES (PA)

Material : Stainless Steel

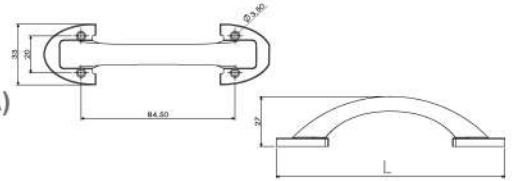

ITEM NO	L	FINISHING	PACKING
HDSS-201	125 mm.	Stainless	
HDSS-202	150 mm.	Stainless	

STAINLESS

มือจับสแตนเลส รุ่นดาวสี่แฉก
STAINLESS HANDLES (PA)

Material : Stainless Steel

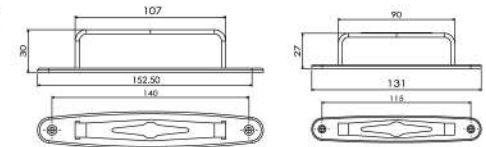

ITEM NO	L	FINISHING	PACKING
HDSS-305	5 inch	Stainless	
HDSS-306	6 inch	Stainless	

STAINLESS

มือจับสแตนเลส รุ่นฝัງ
STAINLESS HANDLES (PA)

Material : Stainless Steel



ITEM NO	L	FINISHING	PACKING
HDSS-501	30x120 mm.	Stainless	



มือจับอลูมิเนียม
ALUMINIUM HANDLES (IM)

Material : Aluminium

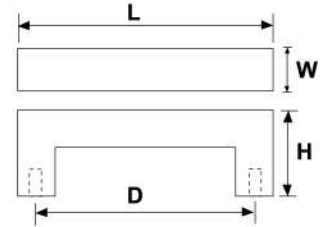

ITEM NO	SIZE (WxLxH)	HOLE DISTANCE	FINISHING	PACKING
MT-002-128		128 mm.	Anodize	
MT-002-160	13x166x34 mm.	160 mm.	Anodize	
MT-002-224	13x232x34 mm.	224 mm.	Anodize	



มือจับอลูมิเนียม
ALUMINIUM HANDLES (IM)

Material : Aluminium

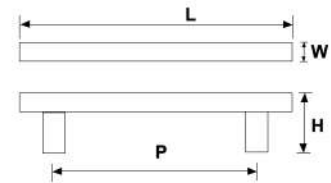

ITEM NO	SIZE (WxLxH)	HOLE DISTANCE	FINISHING	PACKING
MT-590-128	12x150x25 mm.	128 mm.	Anodize	
MT-590-160	12x200x25 mm.	160 mm.	Anodize	
MT-590-192	12x250x25 mm.	192 mm.	Anodize	



มือจับอลูมิเนียม
ALUMINIUM HANDLES (IM)

Material : Aluminium

ITEM NO	HOLE DISTANCE	FINISHING	PACKING
HA-0528-128	128 mm.	Anodize	
HA-0528-160	160 mm.	Anodize	
HA-0528-192	192 mm.	Anodize	



มือจับอลูมิเนียม
ALUMINIUM HANDLES (PA)

Material : ALUMINIUM

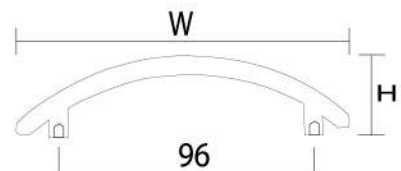

ITEM NO	HOLE DISTANCE	SIZE(WxH)	FINISH	PACKING
THA-0001-96	96 mm.	128 x28.5 mm.	Anodize	

A



มือจับอลูมิเนียม
ALUMINIUM HANDLES (IM)

Material : Aluminium

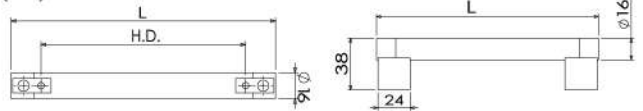

ITEM NO	HOLE DISTANCE	FINISHING	PACKING
HA-06481-96	96 mm.	Anodize	
HA-06481-128	128 mm.	Anodize	
HA-06481-160	160 mm.	Anodize	



มือจับอลูมิเนียม
ALUMINIUM HANDLES (IM)

Material : Aluminium

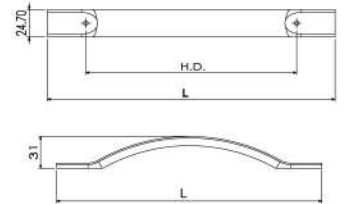

ITEM NO	HOLE DISTANCE	FINISHING	PACKING
HA-06445-192	192 mm.	Anodize	
HA-06445-224	224 mm.	Anodize	



มือจับอลูมิเนียม
ALUMINIUM HANDLES (IM)

Material : Aluminium

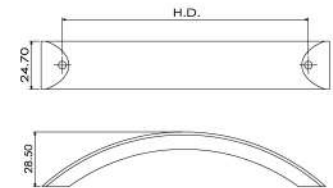

ITEM NO	HOLE DISTANCE	FINISHING	PACKING
HA-0590-128	128 mm.	Anodize	
HA-0590-160	160 mm.	Anodize	
HA-0590-192	192 mm.	Anodize	



มือจับอลูมิเนียม
ALUMINIUM HANDLES (IM)

Material : Aluminium

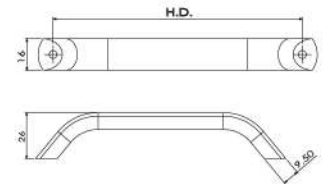

ITEM NO	HOLE DISTANCE	FINISHING	PACKING
HA-06133-128	128 mm.	Anodize	
HA-06133-160	160 mm.	Anodize	
HA-06133-192	192 mm.	Anodize	



มือจับอลูมิเนียม
ALUMINIUM HANDLES (IM)

Material : ALUMINIUM

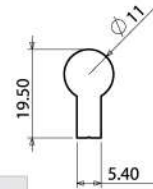

ITEM NO	HOLE DISTANCE	FINISHING	PACKING
HA-0504-64	64 mm.	Anodize	
HA-0504-96	96 mm.	Anodize	
HA-0504-128	128 mm.	Anodize	
HA-0504-192	192 mm.	Anodize	



มือจับอลูมิเนียม
ALUMINIUM HANDLES (IM)

Material : ALUMINIUM



ITEM NO	HOLE DISTANCE	FINISHING	PACKING
HA-0505-64	64 mm.	Anodize	
HA-0505-96	96 mm.	Anodize	
HA-0505-128	128 mm.	Anodize	
HA-0505-192	192 mm.	Anodize	



มือจับอลูมิเนียม
ALUMINIUM HANDLES (IM)

Material : ALUMINIUM

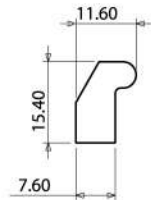

ITEM NO	HOLE DISTANCE	FINISHING	PACKING
HA-0513-64	64 mm.	Anodize	
HA-0513-96	96 mm.	Anodize	
HA-0513-128	128 mm.	Anodize	
HA-0513-192	192 mm.	Anodize	



มือจับอลูมิเนียม
ALUMINIUM HANDLES (IM)

Material : ALUMINIUM

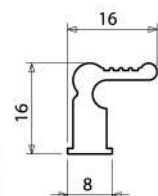

ITEM NO	HOLE DISTANCE	FINISHING	PACKING
HA-0518-64	64 mm.	Anodize	
HA-0518-96	96 mm.	Anodize	
HA-0518-128	128 mm.	Anodize	
HA-0518-192	192 mm.	Anodize	



มือจับอลูมิเนียม
ALUMINIUM HANDLES (IM)

Material : Aluminium

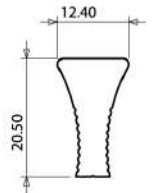

ITEM NO	HOLE DISTANCE	FINISHING	PACKING
HA-0524-64	64 mm.	Anodize	
HA-0524-96	96 mm.	Anodize	
HA-0524-128	128 mm.	Anodize	
HA-0524-192	192 mm.	Anodize	



มือจับอลูมิเนียม
ALUMINIUM HANDLES (IM)

Material : Aluminium

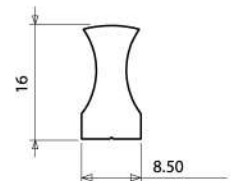

ITEM NO	HOLE DISTANCE	FINISHING	PACKING
YCA-0503-64	64 mm.	Anodize	
YCA-0503-96	96 mm.	Anodize	
YCA-0503-128	128 mm.	Anodize	
YCA-0503-192	192 mm.	Anodize	



มือจับซิงค์อัลลอย

ZINC ALLOY HANDLES (PA)

Material : Zinc Alloy

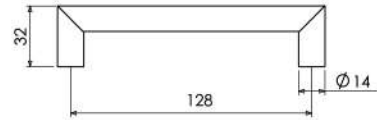

ITEM NO	HOLE DISTANCE	FINISHING	PACKING
BKT-002	128 mm.	Satin(SA)	



มือจับซิงค์อัลลอย

ZINC ALLOY HANDLES (PA)

Material : Zinc Alloy

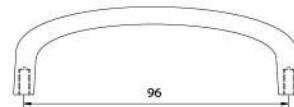

ITEM NO	HOLE DISTANCE	FINISHING	PACKING
TH-1999-96SA	96 mm.	Satin(SA)	
TH-1999-96CR	96 mm.	Chromium(CR)	



มือจับซิงค์อัลลอย

ZINC ALLOY HANDLES (PA)

Material : Zinc Alloy

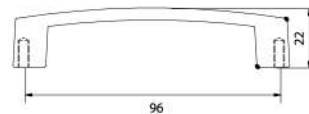

ITEM NO	HOLE DISTANCE	FINISHING	PACKING
NH-20-96SA	96 mm.	Satin(SA)	
NH-20-96CR	96 mm.	Chromium(CR)	



มือจับซิงค์อัลลอย

ZINC ALLOY HANDLES (PA)

Material : Zinc Alloy

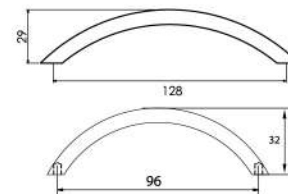

ITEM NO	HOLE DISTANCE	FINISHING	PACKING
P-2622-96SA	96 mm.	Satin(SA)	
P-2622-96CR	96 mm.	Chromium(CR)	
P-2622-128SA	128 mm.	Satin(SA)	
P-2622-128CR	128 mm.	Chromium(CR)	

A



มือจับซิงค์อัลลอย

ZINC ALLOY HANDLES (PA)

Material : Zinc Alloy

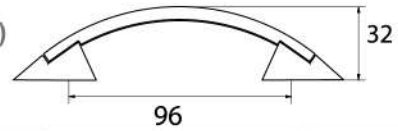

ITEM NO	HOLE DISTANCE	FINISHING	PACKING
P-2379-96B-CR	96 mm.	Black-Chromium(B-CR)	
P-2379-96B-G	96 mm.	Black-Gold(B-G)	
P-2379-96B-SA	96 mm.	Black-Satin(B-SA)	
P-2379-96SA-B	96 mm.	Satin-Black(SA-B)	

มือจับซิงค์อัลลอย

ZINC ALLOY HANDLES (PA)

Material : Zinc Alloy

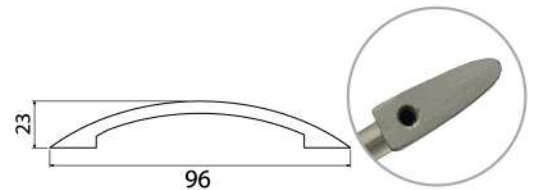

ITEM NO	HOLE DISTANCE	FINISHING	PACKING
P-2456-96SA	96 mm.	Satin(SA)	
P-2456-96CR	96 mm.	Chromium(CR)	
P-2456-96G	96 mm.	Gold(G)	

มือจับซิงค์อัลลอย

ZINC ALLOY HANDLES (PA)

Material : Zinc Alloy

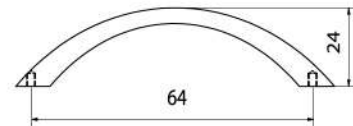

ITEM NO	HOLE DISTANCE	FINISHING	PACKING
P-2380-96SA	64 mm.	Satin(SA)	
P-2380-64CR	64 mm.	Chromium(CR)	
P-2380-64NI	64 mm.	Nickle(NI)	

มือจับซิงค์อัลลอย

ZINC ALLOY HANDLES (PA)

Material : Zinc Alloy

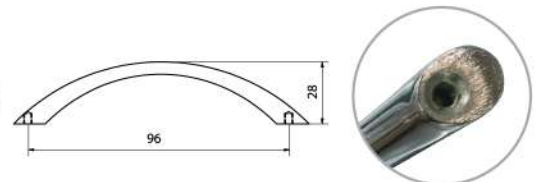

ITEM NO	HOLE DISTANCE	FINISHING	PACKING
P-2381-96SA	96 mm.	Satin(SA)	
P-2381-96CR	96 mm.	Chromium(CR)	



มือจับซิงค์อัลลอย

ZINC ALLOY HANDLES (PA)

Material : Zinc Alloy

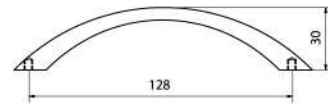

A

ITEM NO	HOLE DISTANCE	FINISHING	PACKING
P-2382-128SA	128 mm.	Satin(SA)	
P-2382-128CR	128 mm.	Chromium(CR)	



มือจับซิงค์อัลลอย

ZINC ALLOY HANDLES (PA)

Material : Zinc Alloy

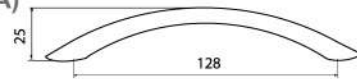

ITEM NO	HOLE DISTANCE	FINISHING	PACKING
TH-2001-128G	128 mm.	Gold(G)	
TH-2001-128CR	128 mm.	Chromium(CR)	



มือจับซิงค์อัลลอย

ZINC ALLOY HANDLES (PA)

Material : Zinc Alloy

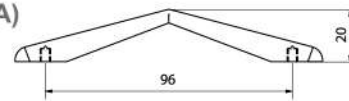

ITEM NO	HOLE DISTANCE	FINISHING	PACKING
P-2304-64SA	64 mm.	Satin(SA)	
P-2304-64CR	64 mm.	Chromium(CR)	
P-2304-96SA	96 mm.	Satin(SA)	
P-2304-96CR	96 mm.	Chromium(CR)	



มือจับซิงค์อัลลอย

ZINC ALLOY HANDLES (PA)

Material : Zinc Alloy

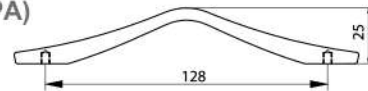

ITEM NO	HOLE DISTANCE	FINISHING	PACKING
P-2477-128SA	128 mm.	Satin(SA)	
P-2477-128CR	128 mm.	Chromium(CR)	

A



มือจับซิงค์อัลลอย

ZINC ALLOY HANDLES (PA)

Material : Zinc Alloy

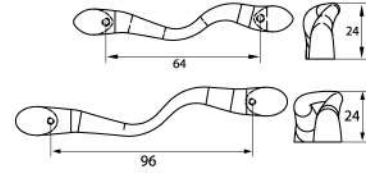

ITEM NO	HOLE DISTANCE	FINISHING	PACKING
P-2610-64CR	64 mm.	Chromium(CR)	
P-2610-96SA	96 mm.	Satin(SA)	
P-2610-96CR	96 mm.	Chromium(CR)	



มือจับซิงค์อัลลอย

ZINC ALLOY HANDLES (PA)

Material : Zinc Alloy

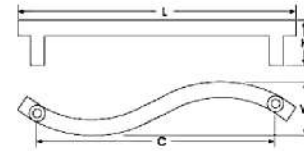

ITEM NO	HOLE DISTANCE	FINISHING	PACKING
P-2475-96CR	96 mm.	Gold(G)	



มือจับซิงค์อัลลอย

ZINC ALLOY HANDLES

Material : Zinc Alloy

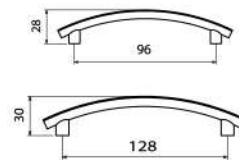

ITEM NO	HOLE DISTANCE	FINISHING	PACKING
P-2620-96SA	96 mm.	Satin(SA)	
P-2620-128CR	128 mm.	Chromium(CR)	

PA
IM



มือจับซิงค์อัลลอย

ZINC ALLOY HANDLES

Material : Zinc Alloy

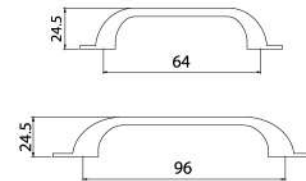

ITEM NO	HOLE DISTANCE	FINISHING	PACKING
KC-80-64	64 mm.	Satin(SA)	
KC-80-96	96 mm.	Satin(SA)	



มือจับซิงค์อัลลอย

ZINC ALLOY HANDLES

Material : Zinc Alloy

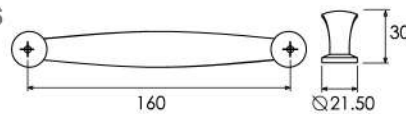

ITEM NO	HOLE DISTANCE	FINISHING	PACKING
P-2601-160SA	160 mm.	Satin(SA)	
P-2601-160NI	160 mm.	Nickel(NI)	



มือจับซิงค์อัลลอย

ZINC ALLOY HANDLES (PA)

Material : Zinc Alloy

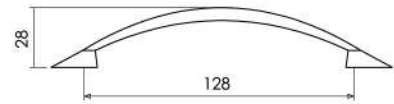

ITEM NO	HOLE DISTANCE	FINISHING	PACKING
P-2626-128CR	128 mm.	Chromium(CR)	
P-2626-128SA	128 mm.	Satin(SA)	



มือจับซิงค์อัลลอย

ZINC ALLOY HANDLES (PA)

Material : Zinc Alloy

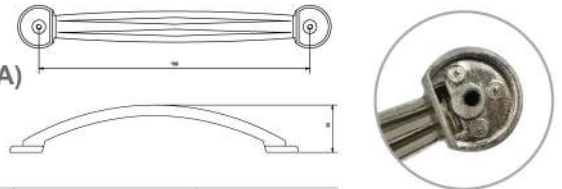

ITEM NO	HOLE DISTANCE	FINISHING	PACKING
C-160CR	160 mm.	Chromium(CR)	
C-160SA	160 mm.	Satin(SA)	



มือจับซิงค์อัลลอย

ZINC ALLOY HANDLES (PA)

Material : Zinc Alloy

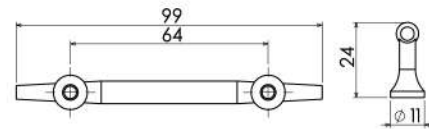

ITEM NO	HOLE DISTANCE	FINISHING	PACKING
PZ-3008	64 mm.	Chromium(CR)	



มือจับซิงค์อัลลอย

ZINC ALLOY HANDLES (IM)

Material : Zinc Alloy

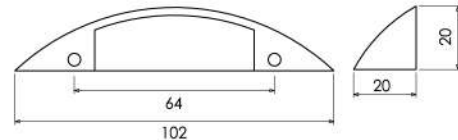

ITEM NO	HOLE DISTANCE	FINISHING	PACKING
P-2609-64SA	64 mm.	Satin(SA)	
P-2609-64CR	64 mm.	Chromium(CR)	



มือจับซิงค์อัลลอย

ZINC ALLOY HANDLES (IM)

Material : Zinc Alloy

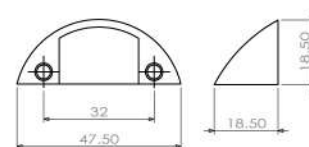

ITEM NO	HOLE DISTANCE	FINISHING	PACKING
P-2609-32SA	32 mm.	Satin(SA)	
P-2609-32CR	32 mm.	Chromium(CR)	

A

NEW
PRODUCT



มือจับซิงค์อัลลอย
ZINC ALLOY HANDLES (IM)

Material : Zinc Alloy

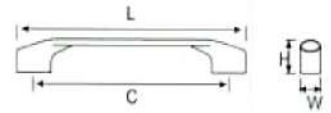

ITEM NO	HOLE DISTANCE	FINISHING	PACKING
HDZN-A638-96B	96 mm.	Black Matt	
HDZN-A638-128B	128 mm.	Black Matt	

NEW
PRODUCT



มือจับซิงค์อัลลอย
ZINC ALLOY HANDLES (IM)

Material : Zinc Alloy

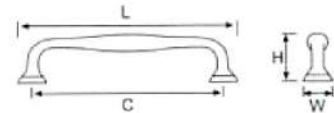

ITEM NO	HOLE DISTANCE	FINISHING	PACKING
HDZN-A664-96B	96 mm.	Black Matt	
HDZN-A664-128B	128 mm.	Black Matt	

NEW
PRODUCT



มือจับซิงค์อัลลอย
ZINC ALLOY HANDLES (IM)

Material : Zinc Alloy

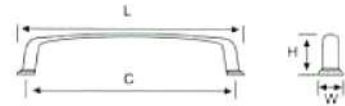

ITEM NO	HOLE DISTANCE	FINISHING	PACKING
HDZN-A665-96B	96 mm.	Black Matt	
HDZN-A665-128B	128 mm.	Black Matt	

NEW
PRODUCT



มือจับซิงค์อัลลอย
ZINC ALLOY HANDLES (IM)

Material : Zinc Alloy

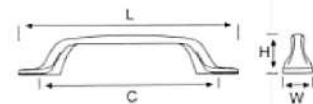

ITEM NO	HOLE DISTANCE	FINISHING	PACKING
HDZN-A668-96B	96 mm.	Black Matt	
HDZN-A668-128B	128 mm.	Black Matt	

NEW
PRODUCT



ปุ่มจับซิงค์อัลลอย
ZINC ALLOY HANDLES (IM)

Material : Zinc Alloy

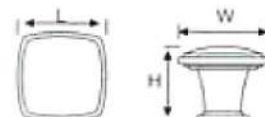

ITEM NO	HOLE DISTANCE	FINISHING	PACKING
KNZA-A640B	96 mm.	Black Matt	

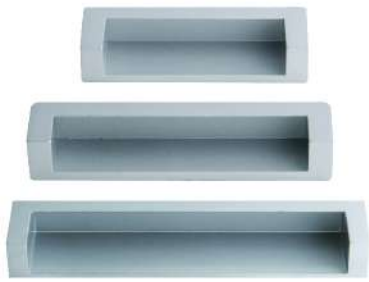

มือจับฝังซึ่งค์อัลลอย
FLUSH ZINC ALLOY HANDLES (IM)

Material : Zinc Alloy

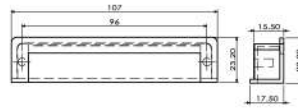
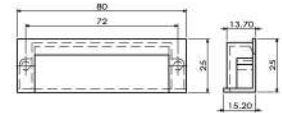

ITEM NO	HOLE DISTANCE	FINISHING	PACKING
HA-0824-72	72 mm.	Satin(SA)	
HA-0825-96	96 mm.	Satin(SA)	
HA-0826-128	128 mm.	Satin(SA)	



มือจับฝังซึ่งค์อัลลอย
FLUSH ZINC ALLOY HANDLES (IM)

Material : Zinc Alloy

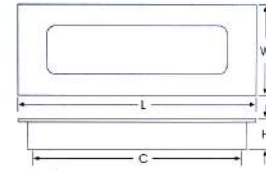

ITEM NO	HOLE DISTANCE	FINISHING	PACKING
HA-06404-64	64x79x42x16 mm.	Satin(SA)	
HA-06404-96	96x111x42x16 mm.	Satin(SA)	
HA-06404-128	128x143x42x16 mm.	Satin(SA)	



มือจับฝังซึ่งค์อัลลอย
FLUSH ZINC ALLOY HANDLES (IM)

Material : Zinc Alloy

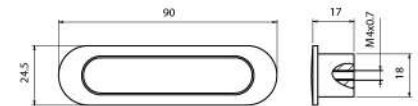

ITEM NO	HOLE DISTANCE	FINISHING	PACKING
HA-0847-32	19x76 mm.	Satin(SA)	



มือจับฝังสแตนเลส
FLUSH STAINLESS HANDLES (IM)

Material : Stainless

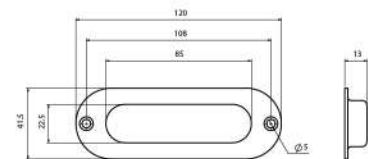

ITEM NO	HOLE DISTANCE	FINISHING	PACKING
PS-3001	41.5x120x13 mm.	Stainless	



มือจับฝังซึ่งค์อัลลอย
FLUSH ZINC ALLOY HANDLES (IM)

Material : Zinc Alloy

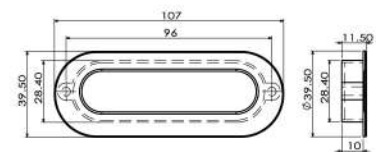

ITEM NO	HOLE DISTANCE	FINISHING	PACKING
YCZ-0856-64CR	64 mm.	Chromium(CR)	
YCZ-0856-96CR	96 mm.	Chromium(CR)	

A



มือจับฝังพลาสติก
FLUSH ZINC ALLOY HANDLES (PA)

Material : Plastic

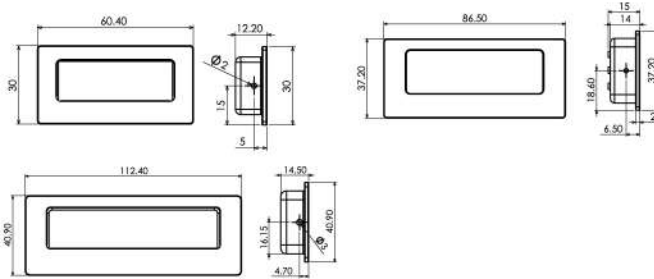

ITEM NO	HOLE DISTANCE	FINISHING	PACKING
PH-03		Chromium(CR)	
PH-04	32x70 mm.	Chromium(CR)	
PH-05	32x94 mm.	Chromium(CR)	



มือจับฝังอลูมิเนียม
FLUSH ALUMINIUM HANDLES (IM)

Material : Aluminium

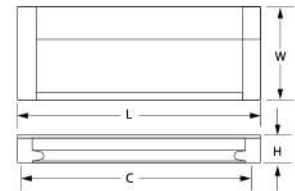

ITEM NO	HOLE DISTANCE	FINISHING	PACKING
HA-0866-64	64x77x43.5x16 mm.	Anodize	
HA-0866-96	96x109x43.5x16 mm.	Anodize	
HA-0866-128	128x141x43.5x16 mm.	Anodize	

**NEW
PRODUCT**



มือจับฝังซิงค์อัลลอย
FLUSH ZINC ALLOY HANDLES (IM)

Material : Zinc Alloy

Finish : Chrome (CR) , Nickel (NI)

ITEM NO	HOLE DISTANCE	PACKING
HDZN-A6101	84 mm.	



มือจับฝังซึ่งค์อัลลอย
ZINC ALLOY HANDLES (IM)

Material : Zinc Alloy

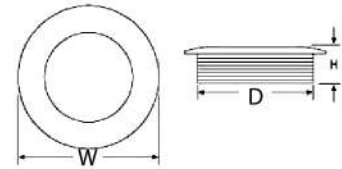

ITEM NO	HOLE DISTANCE	FINISHING	PACKING
YCZ-0850	41.5x35x10.5 mm.	Satin(SA)	



มือจับฝังซึ่งค์อัลลอย
ZINC ALLOY HANDLES (IM)

Material : Zinc Alloy

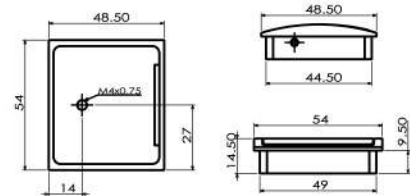

ITEM NO	HOLE DISTANCE	FINISHING	PACKING
HA-0832-32	32 mm.	Satin(SA)	



มือจับฝังซึ่งค์อัลลอย
ZINC ALLOY HANDLES (IM)

Material : Zinc Alloy

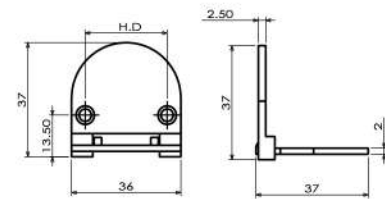

ITEM NO	HOLE DISTANCE	FINISHING	PACKING
HA-0835-26	27 mm.	Satin(SA)	
HA-0835-64	68 mm.	Satin(SA)	



มือจับฝังซึ่งค์อัลลอย
ZINC ALLOY HANDLES (IM)

Material : Zinc Alloy
Finish : Chrome (CR) , Satin (SA)

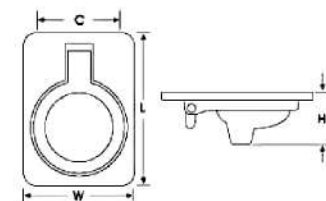

ITEM NO	FINISHING	PACKING
HA-1019SA	Satin (SA)	
HA-1019CR	Chromium (CR)	



L	C	W	H
40	27 mm.	30 mm.	15 mm.

A



มือจับประกายเพชร
DIAMOND HANDLES (IM)

Material : Zinc Alloy

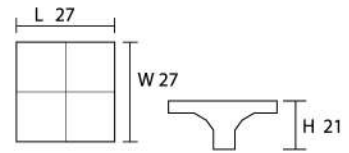

ITEM NO	HOLE DISTANCE	FINISHING	PACKING
DA-07161-2727	27x27 mm.	Chromium(CR)	



มือจับประกายเพชร
DIAMOND HANDLES (IM)

Material : Zinc Alloy

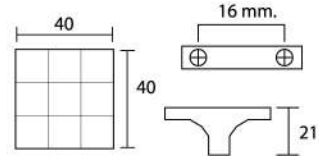

ITEM NO	HOLE DISTANCE	FINISHING	PACKING
DA-07161-4040	16 mm.	Chromium(CR)	



มือจับประกายเพชร
DIAMOND HANDLES (IM)

Material : Zinc Alloy

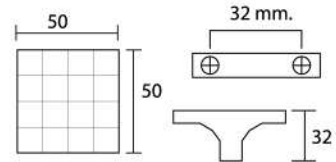

ITEM NO	HOLE DISTANCE	FINISHING	PACKING
DA-07161-5050	32 mm.	Chromium(CR)	



มือจับประกายเพชร
DIAMOND HANDLES (IM)

Material : Zinc Alloy

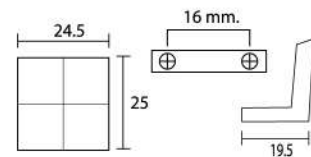

ITEM NO	HOLE DISTANCE	FINISHING	PACKING
DA-07163-3025	16 mm.	Chromium(CR)	



มือจับประกายเพชร
DIAMOND HANDLES (IM)

Material : Zinc Alloy

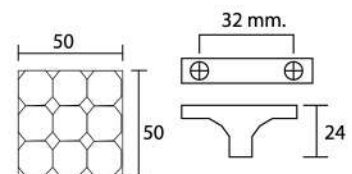

ITEM NO	HOLE DISTANCE	FINISHING	PACKING
DA-07195-32	32 mm.	Chromium(CR)	



มือจับประกายเพชร
DIAMOND HANDLES (IM)

Material : Zinc Alloy

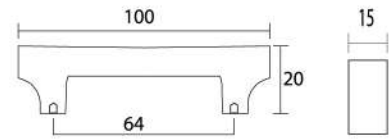

ITEM NO	HOLE DISTANCE	FINISHING	PACKING
DA-07162-64	64 mm.	Chromium(CR)	



มือจับประกายเพชร
DIAMOND HANDLES (IM)

Material : Zinc Alloy

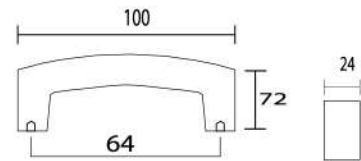

ITEM NO	HOLE DISTANCE	FINISHING	PACKING
DA-07164-64	64 mm.	Chromium(CR)	



มือจับประกายเพชร
DIAMOND HANDLES (IM)

Material : Zinc Alloy

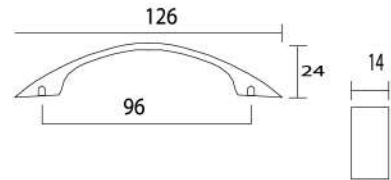

ITEM NO	HOLE DISTANCE	FINISHING	PACKING
DA-07198-96	96 mm.	Chromium(CR)	



มือจับประกายเพชร
DIAMOND HANDLES (IM)

Material : Zinc Alloy

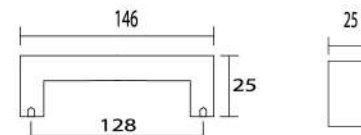

ITEM NO	HOLE DISTANCE	FINISHING	PACKING
DA-07195-128	128 mm.	Chromium(CR)	

A



มือจับประกายเพชร
DIAMOND HANDLES (IM)

Material : Zinc Alloy

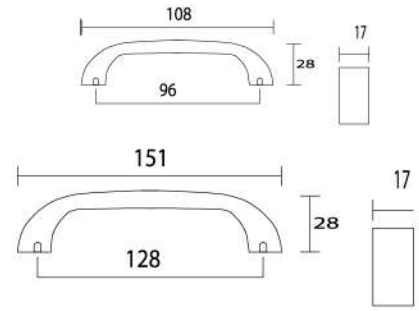

ITEM NO	HOLE DISTANCE	FINISHING	PACKING
DA-07212-96	96 mm.	Chromium(CR)	
DA-07212-128	128 mm.	Chromium(CR)	



มือจับประกายเพชร
DIAMOND HANDLES (IM)

Material : Zinc Alloy

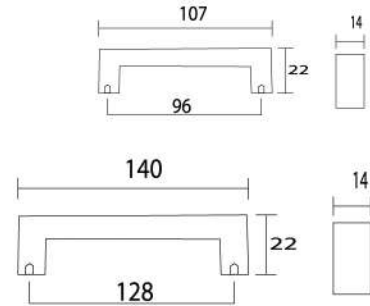

ITEM NO	HOLE DISTANCE	FINISHING	PACKING
DA-07216-96	96 mm.	Chromium(CR)	
DA-07216-128	128 mm.	Chromium(CR)	



มือจับประกายเพชร
DIAMOND HANDLES (IM)

Material : Zinc Alloy

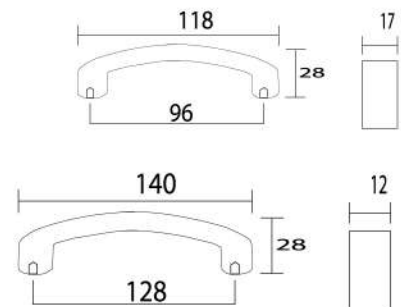

ITEM NO	HOLE DISTANCE	FINISHING	PACKING
DA-07218-96	96 mm.	Chromium(CR)	
DA-07218-128	128 mm.	Chromium(CR)	



มือจับโบราณ
ANTIQUÉ HANDLES (IM)



ITEM NO	SIZE(WxLxH)	FINISHING	PACKING
YCZ-0931AB	20x64x14 mm.	Antique Brass(AB)	



มือจับโบราณ
ANTIQUÉ HANDLES (IM)

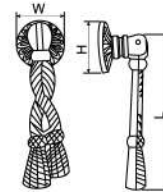

ITEM NO	SIZE(WxLxH)	FINISHING	PACKING
YCZ-0978AB	22x22x64 mm.	Antique Brass(AB)	



มือจับโบราณ
ANTIQUÉ HANDLES (IM)



ITEM NO	SIZE(WxLxH)	FINISHING	PACKING
YCZ-1014CR	-	Chromium(CR)	



มือจับโบราณ
ANTIQUÉ HANDLES (IM)

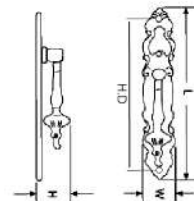

ITEM NO	HOLE DISTANCE	FINISHING	PACKING
YCZ-0909AB	72 mm.	Antique Brass(AB)	



มือจับโบราณ
ANTIQUÉ HANDLES (IM)

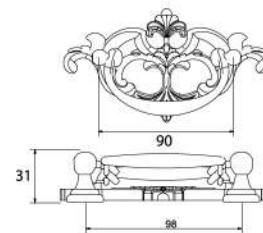

ITEM NO	HOLE DISTANCE	FINISHING	PACKING
YCZ-C0338-AB	64 mm.	Antique Brass(AB)	

A



มือจับโบราณ
ANTIQUÉ HANDLES (IM)

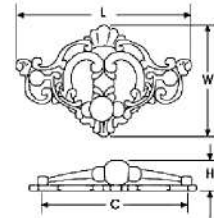

ITEM NO	HOLE DISTANCE	FINISHING	PACKING
YCZ-C0377-AB	64 mm.	Antique Brass(AB)	



มือจับโบราณ
ANTIQUÉ HANDLES (IM)

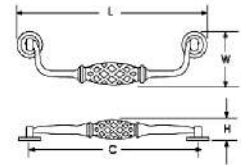

ITEM NO	SIZE(WxLxH)	HOLE DISTANCE	FINISHING	PACKING
YCZ-09296-160AB	43.5x192x30.5 mm.	160 mm.	Antique Brass(AB)	



มือจับโบราณ
ANTIQUÉ HANDLES (IM)

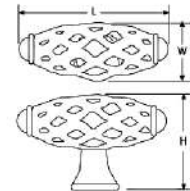

ITEM NO	SIZE(WxLxH)	FINISHING	PACKING
YCZ-09296AB	20x58x36 mm.	Antique Brass(AB)	



มือจับโบราณ
ANTIQUÉ HANDLES (IM)

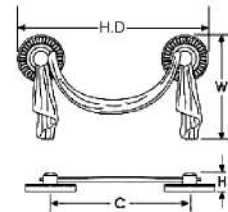

ITEM NO	SIZE(WxLxH)	HOLE DISTANCE	FINISHING	PACKING
YCZ-0930-64AB	58x84x15 mm.	64 mm.	Antique Brass(AB)	



มือจับโบราณ
ANTIQUÉ HANDLES (IM)

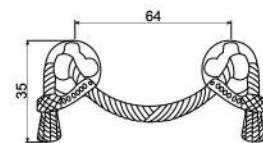

ITEM NO	HOLE DISTANCE	FINISHING	PACKING
YCZ-0977-64AB	64 mm.	Antique Brass(AB)	



มือจับโบราณ
ANTIQUÉ HANDLES (IM)

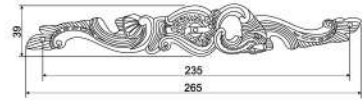

ITEM NO	HOLE DISTANCE	FINISHING	PACKING
YCZ-09263AB	235 mm.	Antique Brass(AB)	



มือจับโบราณ
ANTIQUÉ HANDLES (IM)

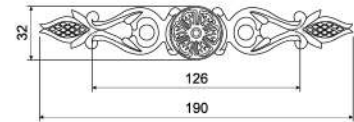

ITEM NO	HOLE DISTANCE	FINISHING	PACKING
YCZ-09273AB	126 mm.	Antique Brass(AB)	



มือจับโบราณ
ANTIQUÉ HANDLES (IM)

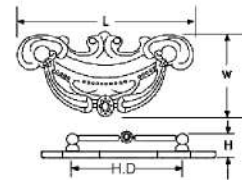

ITEM NO	SIZE(WxLxH)	HOLE DISTANCE	FINISHING	PACKING
YCZ-0902L-AB	55x95x17 mm.	64 mm.	Antique Brass(AB)	



มือจับโบราณ
ANTIQUÉ HANDLES (IM)

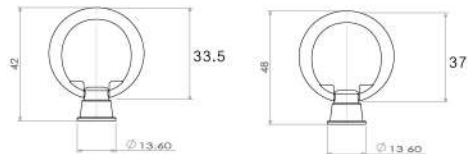

ITEM NO	SIZE	FINISHING	PACKING
KT-10AC	42x13.60x32 mm.	Antique Copper(AC)	
KT-10AB	42x13.60x32 mm.	Antique Brass(AB)	
KT-20AC	48x13.60x32 mm.	Antique Copper(AC)	
KT-20AB	48x13.60x32 mm.	Antique Brass(AB)	



มือจับโบราณ
ANTIQUÉ HANDLES (IM)

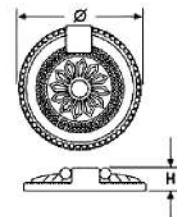

ITEM NO	SIZE(WxH)	FINISHING	PACKING
KTN-10AB	36x10 mm.	Antique Brass(AB)	
KTN-20AB	46x10 mm.	Antique Brass(AB)	

A



มือจับโบราณ
ANTIQUÉ HANDLES (IM)

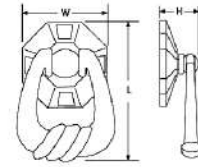

ITEM NO	SIZE(WxLxH)	FINISHING	PACKING
YCZ-09237AC	43x53x22 mm.	Antique Brass(AB)	



มือจับโบราณ
ANTIQUÉ HANDLES (IM)

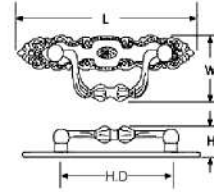

ITEM NO	SIZE(WxLxH)	HOLE DISTANCE	FINISHING	PACKING
YCZ-0908-64AB	38x105x15.5 mm.	64 mm.	Antique Brass(AB)	



มือจับโบราณ
ANTIQUÉ HANDLES (IM)

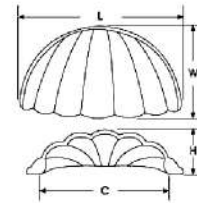

ITEM NO	SIZE(WxLxH)	HOLE DISTANCE	FINISHING	PACKING
YCZ-09153AB	45x88x28 mm.	72 mm.	Antique Brass(AB)	



มือจับโบราณ
ANTIQUÉ HANDLES (IM)

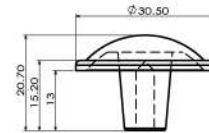

ITEM NO	SIZE	FINISHING	PACKING
KT-30AB	30.5x20.7 mm.	Antique Brass(AB)	
KT-30AC	30.5x20.7 mm.	Antique Copper(AC)	



มือจับโบราณ
ANTIQUÉ HANDLES (IM)

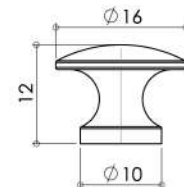

ITEM NO	SIZE(WxLxH)	FINISHING	PACKING
JHESK-1216	10x16x12 mm.	Antique Brass(AB)	



PLASTIC HANDLES

NEW
PRODUCT



มือจับพลาสติก

PLASTIC HANDLES (PA)

Material : Plastic
Finish : Chromium (CR), Satin (SA)

ITEM NO	HOLE DISTANCE	PACKING
PUH-96	96 mm.	
PUH-128	128 mm.	

NEW
PRODUCT



มือจับพลาสติก

PLASTIC HANDLES (PA)

Material : Plastic
Finish : Chromium (CR), Satin (SA)

ITEM NO	HOLE DISTANCE	PACKING
PCH-64	64 mm.	
PCH-96	96 mm.	
PCH-128	128 mm.	

NEW
PRODUCT



มือจับพลาสติก

PLASTIC HANDLES (PA)

Material : Plastic
Finish : Chromium(CR), Satin(SA), Gold(G)

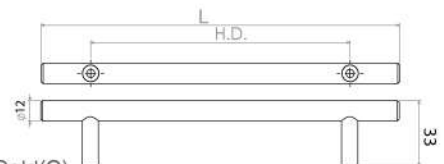

ITEM NO	HOLE DISTANCE	L	PACKING
PTH-96	96 mm.	153 mm.	
PTH-128	128 mm.	181 mm.	
PTH-192	192 mm.	292 mm.	

A

NEW PRODUCT

มือจับฝั้งกลมพลาสติกเล็ก
PLASTIC FLUSH HANDLES (PA)

Material : Plastic
Finish : Chromium (CR), Satin (SA), Black (B)



ITEM NO	HOLE DISTANCE	PACKING
PHO-35	35 mm.	
PHO-40	40 mm.	

NEW PRODUCT

มือจับฝั้งกลมพลาสติกใหญ่
PLASTIC FLUSH HANDLES (PA)

Material : Plastic
Finish : Chromium (CR), Satin (SA)



ITEM NO	HOLE DISTANCE	PACKING
PHO-60	60 mm.	

NEW PRODUCT

มือจับฝั้งพลาสติก
PLASTIC FLUSH HANDLES (PA)

Material : Plastic
Finish : Stainless surface

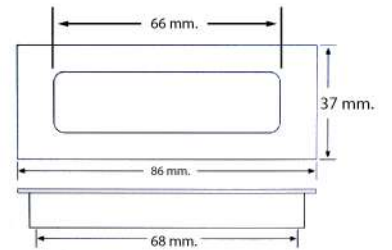

ITEM NO	HOLE DISTANCE	PACKING
PM-14	68 mm.	

NEW PRODUCT

มือจับฝั้งพลาสติก
PLASTIC FLUSH HANDLES (PA)

Material : Plastic
Finish : Chromium (CR), Satin (SA)

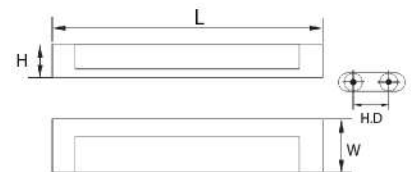

ITEM NO	HOLE DISTANCE	SIZE(WxLxH)	PACKING
P-1731-96	96 mm.	31x109x17 mm.	
P-1731-128	128 mm.	31x139x17 mm.	

NEW PRODUCT

มือจับพลาสติกแบบสามเหลี่ยม
PLASTIC HANDLES (PA)

Material : Plastic
Finish : Black(B)

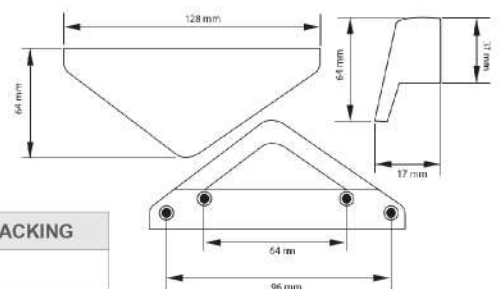

ITEM NO	HOLE DISTANCE	PACKING
P-1764-96	96 mm.	

A

NEW PRODUCT

มือจับพลาสติก

PLASTIC HANDLES (PA)

Material : Plastic
Finish : Chromium (CR), Satin (SA)

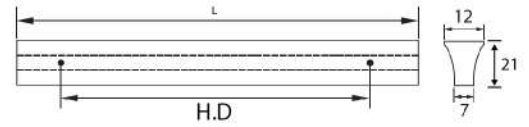

ITEM NO	HOLE DISTANCE	L	PACKING
HDPL-7221-32	32 mm.	40 mm.	
HDPL-7221-64	64 mm.	72 mm.	
HDPL-7221-96	96 mm.	104 mm.	
HDPL-7221-128	128 mm.	171 mm.	

NEW PRODUCT

มือจับพลาสติก

PLASTIC HANDLES (PA)

Material : Plastic
Finish : Satin (SA)

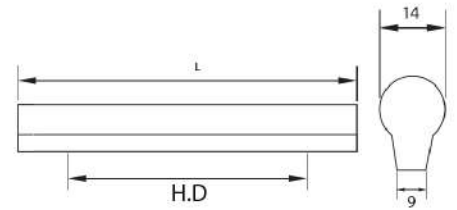

ITEM NO	HOLE DISTANCE	L	PACKING
HDPL-1409-64SA	64 mm.	88 mm.	
HDPL-1409-96SA	96 mm.	120 mm.	
HDPL-1409-128SA	128 mm.	152 mm.	

NEW PRODUCT

มือจับพลาสติก

PLASTIC HANDLES (PA)

Material : Plastic
Finish : Satin (SA)

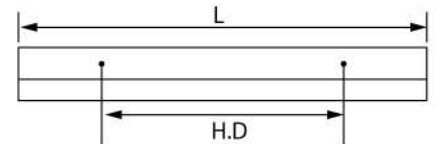

ITEM NO	HOLE DISTANCE	L	PACKING
HDPL-1420-32SA	32 mm.	54 mm.	
HDPL-1420-64SA	64 mm.	84 mm.	
HDPL-1420-96SA	96 mm.	116 mm.	
HDPL-1420-128SA	128 mm.	148 mm.	
HDPL-1420-160SA	160 mm.	180 mm.	

NEW PRODUCT

มือจับพลาสติก

PLASTIC HANDLES (PA)

Material : Plastic
Finish : Satin (SA)

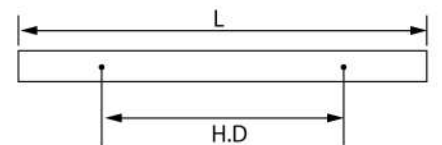

ITEM NO	HOLE DISTANCE	L	PACKING
HDPL-0821-32SA	32 mm.	54 mm.	
HDPL-0821-64SA	64 mm.	84 mm.	
HDPL-0821-96SA	96 mm.	116 mm.	
HDPL-0821-128SA	128 mm.	148 mm.	
HDPL-0821-160SA	160 mm.	180 mm.	

NEW PRODUCT

ปุ่มจับพลาสติก 22 มิล.
PLASTIC KNOBS (PA)

Material : Plastic

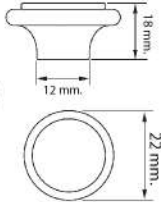

ITEM NO	FINISHING	PACKING
PKDV-22CR	Chromium(CR)	
PKDV-22G	Gold(G)	
PKDV-22SA	Satin(SA)	

NEW PRODUCT

ปุ่มจับพลาสติก 32 มิล.
PLASTIC KNOBS (PA)

Material : Plastic

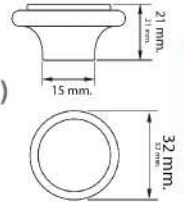

ITEM NO	FINISHING	PACKING
PKCV-32CR	Chromium(CR)	
PKCV-32SA	Satin(SA)	

NEW PRODUCT

ปุ่มจับพลาสติก 17 มิล.
PLASTIC KNOBS (PA)

Material : Plastic

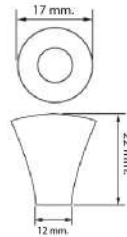

ITEM NO	FINISHING	PACKING
PKGCV-17CR	Chromium(CR)	
PKGCV-17G	Gold(G)	
PKGCV-17SA	Satin(SA)	

NEW PRODUCT

ปุ่มจับพลาสติก 20 มิล.
PLASTIC KNOBS (PA)

Material : Plastic

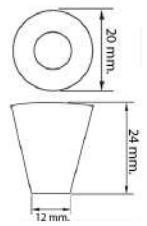

ITEM NO	FINISHING	PACKING
PKEV-20CR	Chromium(CR)	
PKEV-20SA	Satin(SA)	
PKEV-20B	Black(B)	

NEW PRODUCT

ปุ่มจับพลาสติก 25 มิล.
PLASTIC KNOBS (PA)

Material : Plastic

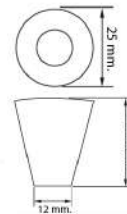

ITEM NO	FINISHING	PACKING
PKEV-25CR	Chromium(CR)	
PKEV-25G	Gold(G)	
PKEV-25SA	Satin(SA)	

NEW PRODUCT

ปุ่มจับพลาสติก 30 มิล.
PLASTIC KNOBS (PA)

Material : Plastic

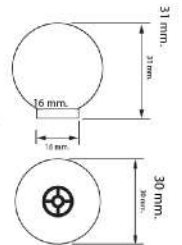

ITEM NO	FINISHING	PACKING
PKPP-30CR	Chromium(CR)	
PKPP-30G	Gold(G)	
PKPP-30SA	Satin(SA)	

NEW PRODUCT

ปุ่มจับพลาสติก 25 มิล.
PLASTIC KNOBS (PA)

Material : Plastic



ITEM NO	FINISHING	PACKING
PKC-25CR	Chromium(CR)	
PKC-25SA	Satin(SA)	





มือจับพลาสติก
PLASTIC HANDLES (PA)

Material : Plastic

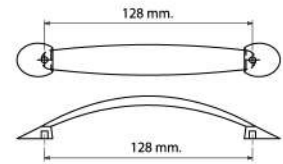

ITEM NO	HOLE DISTANCE	FINISHING	PACKING
P-2626P-128GR	128 mm.	Light Grey(GR)	
P-2626P-128BR	128 mm.	Brown(BR)	



มือจับพลาสติก
PLASTIC HANDLES (PA)

Material : Plastic

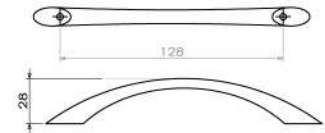

ITEM NO	HOLE DISTANCE	FINISHING	PACKING
P-2382P-128W	128 mm.	White(W)	
P-2382P-128BE	128 mm.	Beigh(BE)	
P-2382P-128GR	128 mm.	Grey(GR)	



มือจับพลาสติก
PLASTIC HANDLES (PA)

Material : Plastic

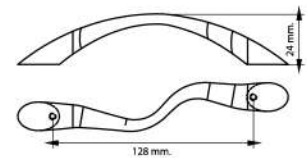

ITEM NO	HOLE DISTANCE	FINISHING	PACKING
P-2610P-128W	128 mm.	White(W)	
P-2610P-128BE	128 mm.	Beigh(BE)	
P-2610P-128GR	128 mm.	Grey(GR)	



มือจับพลาสติก
PLASTIC HANDLES (PA)

Material : Plastic

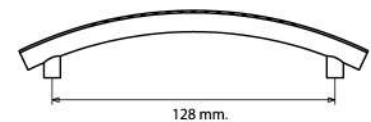

ITEM NO	HOLE DISTANCE	FINISHING	PACKING
P-2620P-128BR	128 mm.	Brown(BR)	
P-2620P-128GR	128 mm.	Light Grey(GR)	
P-2620P-128W	128 mm.	White(W)	



มือจับพลาสติก
PLASTIC HANDLES (PA)

Material : Plastic

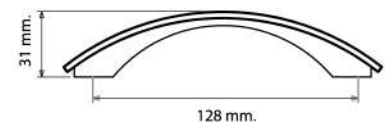

ITEM NO	HOLE DISTANCE	FINISHING	PACKING
P-2624P-128BR	128 mm.	Brown(BR)	
P-2624P-128GR	128 mm.	Light Grey(GR)	
P-2624P-128W	128 mm.	White(W)	

A



ปุ่มจับเหล็ก
STEEL KNOBS (PA)

Material : Steel

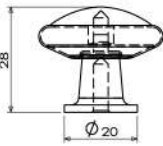

ITEM NO	FINISHING	PACKING
PC-2002	Gold(G)	

ปุ่มจับเหล็ก
STEEL KNOBS (PA)

Material : Steel

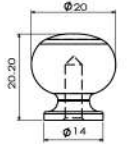

ITEM NO	FINISHING	PACKING
BN-09CR	Chromium(CR)	
BN-09G	Gold(G)	
BN-09SA	Satin(SA)	



ปุ่มจับเหล็ก
STEEL KNOBS (PA)

Material : Steel

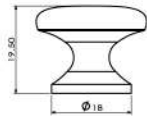

ITEM NO	FINISHING	PACKING
BN-10CR	Chromium(CR)	
BN-10G	Gold(G)	
BN-10SA	Satin(SA)	



ปุ่มจับเหล็ก
STEEL KNOBS (PA)

Material : Steel

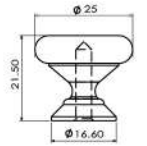

ITEM NO	FINISHING	PACKING
BN-11CR	Chromium(CR)	
BN-11G	Gold(G)	
BN-11SA	Satin(SA)	



ปุ่มจับเหล็ก
STEEL KNOBS (PA)

Material : Steel

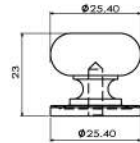

ITEM NO	FINISHING	PACKING
BN-16CR	Chromium(CR)	
BN-16G	Gold(G)	
BN-16SA	Satin(SA)	



ปุ่มจับเหล็ก
STEEL KNOBS (PA)

Material : Steel

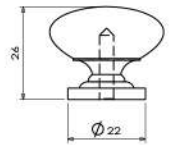

ITEM NO	FINISHING	PACKING
BN-18CR	Chromium(CR)	
BN-18G	Gold(G)	
BN-18SA	Satin(SA)	



ปุ่มจับเหล็ก
STEEL KNOBS (PA)

Material : Steel

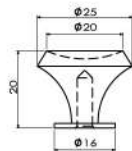

ITEM NO	FINISHING	PACKING
BN-30CR	Chromium(CR)	
BN-30G	Gold(G)	
BN-30SA	Satin(SA)	



ปุ่มจับเหล็ก
STEEL KNOBS (PA)

Material : Steel

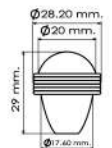

ITEM NO	FINISHING	PACKING
SH-08C-G	Chromium(CR)	
SH-08C-NB	Black Nikle(NB)	



ปุ่มจับเหล็ก
STEEL KNOBS (PA)

Material : Steel

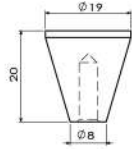

ITEM NO	FINISHING	PACKING
SH-09CR	Chromium(CR)	
SH-09SA	Satin(G)	



ปุ่มจับเหล็ก
STEEL KNOBS (PA)

Material : Steel

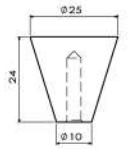

ITEM NO	FINISHING	PACKING
SH-010CR	Chromium(CR)	
SH-010G	Gold(G)	
SH-010B	Black(B)	

A



ปุ่มจับเหล็ก
STEEL KNOBS (PA)

Material : Steel

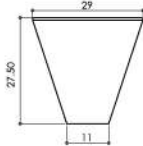

ITEM NO	FINISHING	PACKING
SH-011CR	Chromium(CR)	
SH-011G	Gold(G)	
SH-011SA	Satin(SA)	



ปุ่มจับเหล็ก
STEEL KNOBS (PA)

Material : Steel

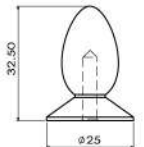

ITEM NO	FINISHING	PACKING
TK-010	Gold(G)	



ปุ่มจับเหล็ก
STEEL KNOBS (PA)

Material : Steel

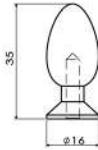

ITEM NO	FINISHING	PACKING
TK-011CR	Chromium(CR)	
TK-011G	Gold(G)	
TK-011GG	Gold(GG)	
TK-011SA	Satin(SA)	



ปุ่มจับเหล็ก
STEEL KNOBS (PA)

Material : Steel

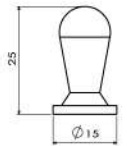

ITEM NO	FINISHING	PACKING
TK-012CR	Chromium(CR)	
TK-012G	Gold(G)	
TK-012SA	Satin(SA)	



ปุ่มจับเหล็ก
STEEL KNOBS (PA)

Material : Steel



ITEM NO	FINISHING	PACKING
TK-014CR	Chromium(CR)	
TK-014G	Gold(G)	
TK-014SA	Satin(SA)	



ปุ่มจับเหล็ก
STEEL KNOBS (PA)

Material : Steel



ITEM NO	FINISHING	PACKING
TK-017CR	Chromium(CR)	
TK-017G	Gold(G)	
TK-017SA	Satin(SA)	

A



ปุ่มจับเหล็ก
STEEL KNOBS (PA)

Material : Steel

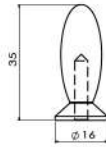

ITEM NO	FINISHING	PACKING
TK-019CR	Chromium(CR)	
TK-019G	Gold(G)	
TK-019SA	Satin(SA)	



ปุ่มจับเหล็ก
STEEL KNOBS (PA)

Material : Steel

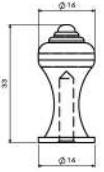

ITEM NO	FINISHING	PACKING
TK-020CR	Chromium(CR)	
TK-020G	Gold(G)	
TK-020SA	Satin(SA)	



ปุ่มจับเหล็ก
STEEL KNOBS (PA)

Material : Steel



ITEM NO	FINISHING	PACKING
TK-20S-C	Satin(SA) Chromium(CR)	
TK-20G-CR	Gold(G) Chromium(CR)	



ปุ่มจับเหล็ก
STEEL KNOBS (PA)

Material : Steel

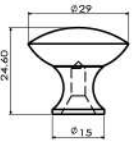

ITEM NO	FINISHING	PACKING
TK-7701	Satin(SA)	



ปุ่มจับเหล็ก
STEEL KNOBS (PA)

Material : Steel

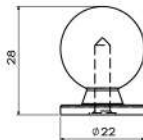

ITEM NO	FINISHING	PACKING
TO-10G	Gold(G)	



ปุ่มจับเหล็ก
STEEL KNOBS (PA)

Material : Steel

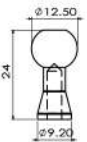

ITEM NO	FINISHING	PACKING
TW-10CR	Chromium(CR)	
TW-10G	Gold(G)	
TW-10SA	Satin(SA)	



ปุ่มจับเหล็ก
STEEL KNOBS (PA)

Material : Steel

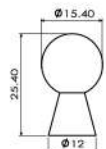

ITEM NO	FINISHING	PACKING
TK-10G	Gold(G)	
TK-10SA	Satin(SA)	



ปุ่มจับสแตนเลส
STAINLESS STEEL KNOBS (PA)

Material : Stainless

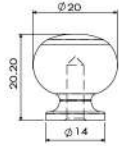

ITEM NO	FINISHING	PACKING
SSBN-09	Burnished,Matte	



ปุ่มจับสแตนเลส
STAINLESS STEEL KNOBS (PA)

Material : Stainless

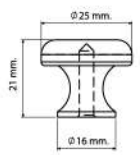

ITEM NO	FINISHING	PACKING
SSBN-10	Burnished,Matte	



ปุ่มจับสแตนเลส
STAINLESS STEEL KNOBS (PA)

Material : Stainless

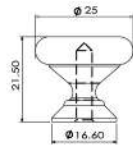

ITEM NO	FINISHING	PACKING
SSBN-11	Burnished,Matte	



ปุ่มจับสแตนเลส
STAINLESS STEEL KNOBS (PA)

Material : Stainless

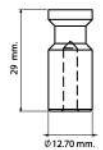

ITEM NO	FINISHING	PACKING
SSBN-030	Burnished,Matte	



ปุ่มจับสแตนเลส
STAINLESS STEEL KNOBS (PA)

Material : Stainless



ITEM NO	FINISHING	PACKING
SSBN-031	Burnished,Matte	



ปุ่มจับสแตนเลส
STAINLESS STEEL KNOBS (PA)

Material : Stainless

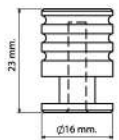

ITEM NO	FINISHING	PACKING
SSBN-032	Burnished,Matte	



ปุ่มจับสแตนเลส
STAINLESS STEEL KNOBS (PA)

Material : Stainless

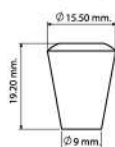

ITEM NO	FINISHING	PACKING
SSSH-07	Burnished,Matte	



ปุ่มจับสแตนเลส
STAINLESS STEEL KNOBS (PA)

Material : Stainless

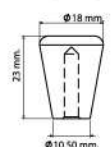

ITEM NO	FINISHING	PACKING
SSSH-08	Burnished,Matte	

A



ปุ่มจับสแตนเลส
STAINLESS STEEL KNOBS (PA)

Material : Stainless

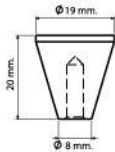

ITEM NO	FINISHING	PACKING
SSSH-09	Burnished,Matte	



ปุ่มจับสแตนเลส
STAINLESS STEEL KNOBS (PA)

Material : Stainless

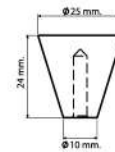

ITEM NO	FINISHING	PACKING
SSSH-010	Burnished,Matte	



ปุ่มจับสแตนเลส
STAINLESS STEEL KNOBS (PA)

Material : Stainless

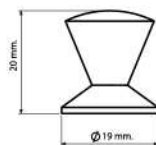

ITEM NO	FINISHING	PACKING
SSTF-10	Burnished,Matte	



ปุ่มจับสแตนเลส
STAINLESS STEEL KNOBS (PA)

Material : Stainless

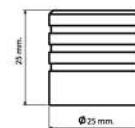

ITEM NO	FINISHING	PACKING
SSSH-013	Burnished,Matte	



ปุ่มจับสแตนเลส
STAINLESS STEEL KNOBS (PA)

Material : Stainless

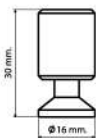

ITEM NO	FINISHING	PACKING
SSTK-013	Burnished,Matte	



ปุ่มจับสแตนเลส
STAINLESS STEEL KNOBS (PA)

Material : Stainless

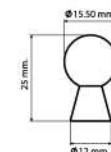

ITEM NO	FINISHING	PACKING
SSTK-10	Burnished,Matte	



ปุ่มจับสแตนเลส
STAINLESS STEEL KNOBS (PA)

Material : Stainless

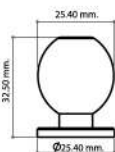

ITEM NO	FINISHING	PACKING
SSTO-10	Burnished,Matte	



ปุ่มจับสแตนเลส
STAINLESS STEEL KNOBS (PA)

Material : Stainless

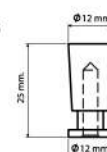

ITEM NO	FINISHING	PACKING
SSTK-014	Burnished,Matte	



ปุ่มจับสแตนเลส
STAINLESS STEEL KNOBS (PA)

Material : Stainless

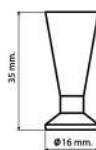

ITEM NO	FINISHING	PACKING
SSSH-07	Burnished,Matte	



ปุ่มจับซิงค์อัลลอย
ZINC ALLOY KNOBS (PA)

Material : Zinc Alloy

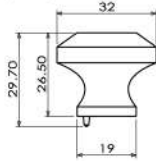

ITEM NO	FINISHING	PACKING
KZ-6401	Satin(SA)	



ปุ่มจับซิงค์อัลลอย
ZINC ALLOY KNOBS (PA)

Material : Zinc Alloy

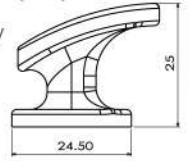

ITEM NO	FINISHING	PACKING
2611S	Satin(SA)	
2611G	Gold(G)	
P-2611S	Chromium(CR)	
P-2611G	Gold(G)	



ปุ่มจับซิงค์อัลลอย
ZINC ALLOY KNOBS (IM)

Material : Zinc Alloy

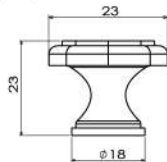

ITEM NO	FINISHING	PACKING
YCZ-0975AC	Antique copper(AC)	
YCZ-0975G-L	Gold(G)	



ปุ่มจับซิงค์อัลลอย
ZINC ALLOY KNOBS (IM)

Material : Zinc Alloy

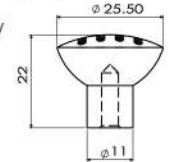

ITEM NO	FINISHING	PACKING
YCZ-1026L	Satin(SA)	
YCZ-1026S	Satin(SA)	



ปุ่มจับไม้
WOODEN KNOBS (PA)

Material : Wood

ITEM NO	SIZE(WxH)	FINISHING	PACKING
W-3	32x32.5 mm.	Cherry Brown	
W-4	31x31 mm.	Black	
W-5	32x33 mm.	Brown	
W-6	33x32 mm.	Light Brown	



ปุ่มจับไม้
WOODEN KNOBS (PA)

Material : Wood

ITEM NO	SIZE(WxH)	FINISHING	PACKING
W-8	34x28 mm.	Light Brown	
W-13	35x27 mm.	Brown	



ปุ่มจับไม้
WOODEN KNOBS (PA)

Material : Wood

ITEM NO	SIZE(WxH)	FINISHING	PACKING
W-9	33x28.5 mm.	Light Brown	
W-14	32.5x28.5 mm.	Brown	



ปุ่มจับไม้
WOODEN KNOBS (PA)

Material : Wood

ITEM NO	SIZE(WxH)	FINISHING	PACKING
W-17	33x32 mm.	Brown	



ปุ่มจับไม้
WOODEN KNOBS (PA)

Material : Wood

ITEM NO	SIZE(WxH)	FINISHING	PACKING
W-18	35x29 mm.	Light Brown	



ปุ่มจับไม้
WOODEN KNOBS (PA)

Material : Wood

ITEM NO	SIZE(WxH)	FINISHING	PACKING
W-19	35x29 mm.	Light Brown	
W-20	38.5x29 mm.	Dark Brown	
W-21	38x31 mm.	Brown	



ปุ่มจับไม้
WOODEN KNOBS (PA)

Material : Wood

ITEM NO	SIZE(WxH)	FINISHING	PACKING
WB-12	35x29.5 mm.	Dark Brown	
WB-13	37x29 mm.	Cherry Brown	
WB-15	40x29 mm.	Brown	



ปุ่มจับไม้
WOODEN KNOBS (PA)

Material : Wood

ITEM NO	SIZE(WxH)	FINISHING	PACKING
WB-21	31x29 mm.	Light Brown	
WB-22	30x28 mm.	Dark Brown	
WB-23	30x28 mm.	Cherry Brown	
WB-24	29x27.5 mm.	Black	
WB-25	35x27 mm.	Brown	

WERA

A

- FURNITURE FITTINGS • INTERIOR PRODUCTS
- ARCHITECTURAL HARDWARES

สินค้าอลูมิเนียม ALUMINIUM PRODUCTS

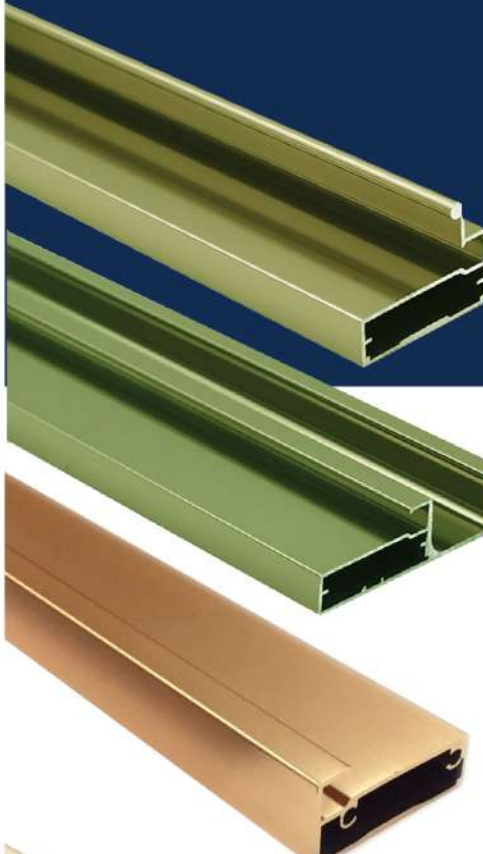

กรอบเฟรมอลูมิเนียม
สำหรับบานประตู ตู้เฟอร์นิเจอร์ต่างๆ

มือจับอลูมิเนียมโปรไฟล์
PROFILE
HANDLES

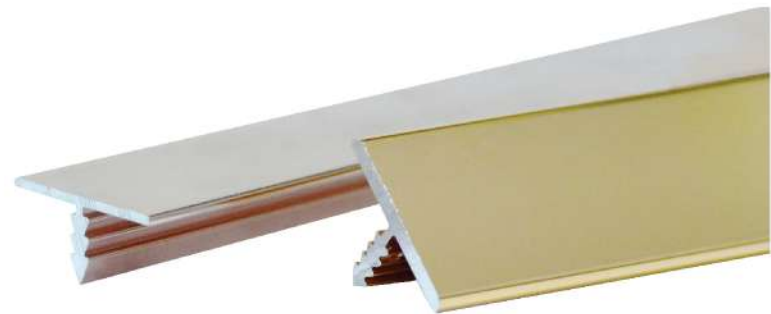

คิ้วอลูมิเนียมพังไม้
T-WALL ALUMINIUM
เส้นอลูมิเนียมสำหรับงานตกแต่ง

A



มือจับอลูมิเนียมเนียมโปรไฟล์ สำหรับไม้หนา 16 และ 19 มิลลิเมตร



มือจับอลูมิเนียม ตัวซี สำหรับไม้หนา 16 มิล
ALUMINIUM PROFILE (C SAHAPE) 16 mm. (PA)

Material : Aluminium
 Wood Thickness : 16 mm.

ITEM NO	DESCRIPTION	PACKING
PROAL-3516-3	มือจับอลูมิเนียมตัว C ยาว 3 เมตร	
PROAL-3516AND	มือจับอลูมิเนียมตัว C ยาว 6 เมตร	

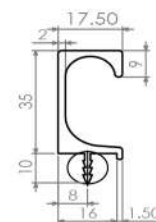

มือจับอลูมิเนียม ตัวซี สำหรับไม้หนา 19 มิล
ALUMINIUM PROFILE (C SAHAPE) 19 mm. (PA)

Material : Aluminium
 Wood Thickness : 19 mm.

ITEM NO	DESCRIPTION	PACKING
PROAL-1935-3	มือจับอลูมิเนียมตัว C ยาว 3 เมตร	
PROAL-1935-6	มือจับอลูมิเนียมตัว C ยาว 6 เมตร	

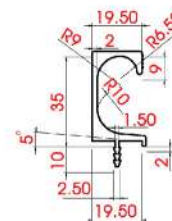

มือจับอลูมิเนียมแบบเฉียง สำหรับไม้หนา 16 มิล
ALUMINIUM PROFILE 16 MM. (PA)

Material : Aluminium
 Wood Thickness : 16 mm.

ITEM NO	DESCRIPTION	PACKING
PROAL-3816-3	มือจับอลูมิเนียมแบบเฉียง ยาว 3 เมตร	
PROAL-3816AND	มือจับอลูมิเนียมแบบเฉียง ยาว 6 เมตร	

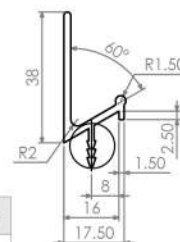

มือจับอลูมิเนียมแบบเฉียง สำหรับไม้หนา 19 มิล
ALUMINIUM PROFILE 19 MM. (PA)

Material : Aluminium
 Wood Thickness : 19 mm.

ITEM NO	DESCRIPTION	PACKING
PROAL-3819-3	มือจับอลูมิเนียมแบบเฉียง ยาว 3 เมตร	
PROAL-3819-6	มือจับอลูมิเนียมแบบเฉียง ยาว 6 เมตร	

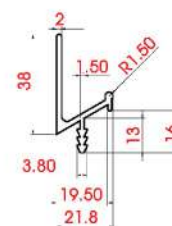



มือจับอลูมิเนียม ตัวยู สำหรับไม้หนา 16 มิล
ALUMINIUM PROFILE (U SHAPE) 16 MM. (PA)

Material : Aluminium
 Wood Thickness : 16 mm.

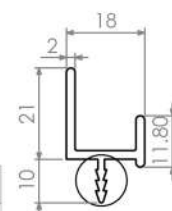

ITEM NO	DESCRIPTION	PACKING
PROAL-2116-3	มือจับอลูมิเนียมแบบตัวยู ยาว 3 เมตร	
PROAL-2116AND	มือจับอลูมิเนียมแบบตัวยู ยาว 6 เมตร	



มือจับอลูมิเนียม ตัวยู สำหรับไม้หนา 19 มิล
ALUMINIUM PROFILE (U SHAPE) 19 MM. (PA)

Material : Aluminium
 Wood Thickness : 19 mm.

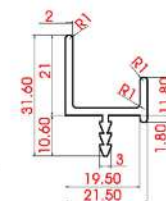

ITEM NO	DESCRIPTION	PACKING
PROAL-3119-3	มือจับอลูมิเนียมแบบตัวยู ยาว 3 เมตร	
PROAL-3119-6	มือจับอลูมิเนียมแบบตัวยู ยาว 6 เมตร	



มือจับอลูมิเนียมแบบคางหมู สำหรับไม้หนา 19 มิล
ALUMINIUM PROFILE (TRAPEZOID) 19 MM. (PA)

Material : Aluminium
 Wood Thickness : 19 mm.



ITEM NO	DESCRIPTION	PACKING
PROAL-3720-3	มือจับอลูมิเนียมแบบคางหมูยาว 3 เมตร	
PROAL-3720-6	มือจับอลูมิเนียมแบบคางหมูยาว 6 เมตร	



เส้นมือจับอลูมิเนียมแบบตัว U เจียง
ALUMINIUM PROFILE (PA)

Material : Aluminium

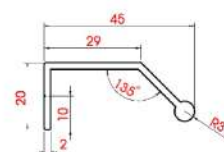

ITEM NO	DESCRIPTION	PACKING
PROAL-4519-3	มือจับอลูมิเนียมตัว U ยาว 3 เมตร	
PROAL-4519-6	มือจับอลูมิเนียมตัว U ยาว 6 เมตร	



เส้นมือจับอลูมิเนียมตัว F
ALUMINIUM PROFILE (F SHAPE) (PA)

Material : Aluminium

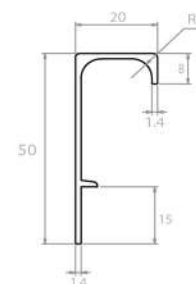

ITEM NO	DESCRIPTION	PACKING
HDAL-2050AND	มือจับอลูมิเนียมตัว F ยาว 6 เมตร	

A



มือจับอลูมิเนียมเหลี่ยม ตัวแอล ALUMINIUM PROFILE (L SHAPE) (PA)

Material : Aluminium

ITEM NO	DESCRIPTION	PACKING
PROAL-2040-3	มือจับอลูมิเนียมเหลี่ยมตัว L ยาว 3 เมตร	
PROAL-2040-6	มือจับอลูมิเนียมเหลี่ยมตัว L ยาว 6 เมตร	

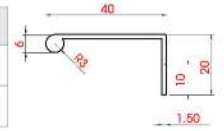

NEW PRODUCT

มือจับอลูมิเนียมเหลี่ยมตัวแอล รุ่นตัดสำเร็จพร้อมเจาะรูสกรู

ITEM NO	L	P	H	PACKING
PROAL-2040-40	40 mm.	32 mm.	20 mm.	
PROAL-2040-80	80 mm.	64 mm.	20 mm.	
PROAL-2040-120	120 mm.	96 mm.	20 mm.	
PROAL-2040-160	160 mm.	120 mm.	20 mm.	
PROAL-2040-200	200 mm.	160 mm.	20 mm.	

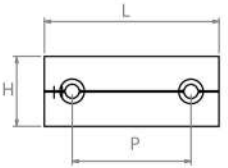

NEW PRODUCT

มือจับอลูมิเนียมเหลี่ยมแบบตัว ยูเฉียง มีร่องขนแปรงด้านบน ALUMINIUM PROFILE (PA)

Material : Aluminium

ITEM NO	DESCRIPTION	PACKING
PROAL-4660	เส้นมือจับอลูมิเนียมเหลี่ยมตัว U เฉียง ยาว 6 เมตร มีร่องขนแปรงบน	

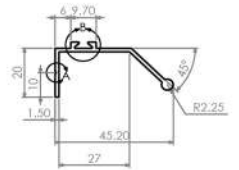

NEW PRODUCT

มือจับอลูมิเนียมเหลี่ยม แบบตัวยูเฉียง มีร่องขนแปรงล่าง ALUMINIUM PROFILE (PA)

Material : Aluminium

ITEM NO	DESCRIPTION	PACKING
PROAL-4662	มือจับอลูมิเนียมเหลี่ยมตัว U เฉียง ยาว 6 เมตร มีร่องขนแปรงล่าง	

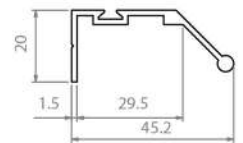

NEW PRODUCT

สีกหลาดบานเลื่อนกันฝุ่นสีเทา DUST COVER BRUSH (PA)

Material : Plastic PP (แปรง)

ITEM NO	SIZE	PACKING
ABPL-05400GR	400 M.	



**NEW
PRODUCT**

**มือจับอลูมิเนียม
ALUMINIUM PROFILE (PA)**

Material : Aluminium

ITEM NO	LENGTH	PACKING
PROAL-H-03-3	3 M.	

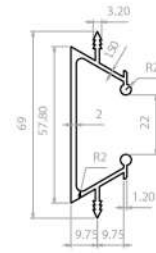

**NEW
PRODUCT**

**มือจับอลูมิเนียม
ALUMINIUM PROFILE (PA)**

Material : Aluminium

ITEM NO	LENGTH	PACKING
PROAL-H-04-3	3 M.	

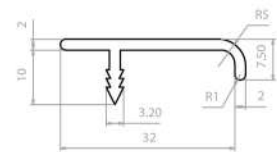

**NEW
PRODUCT**

**มือจับอลูมิเนียม
ALUMINIUM PROFILE (PA)**

Material : Aluminium

ITEM NO	LENGTH	PACKING
PROAL-H-05-3	3 M.	

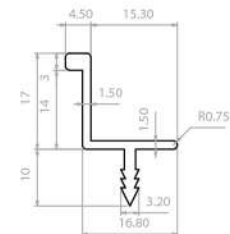

**NEW
PRODUCT**

**มือจับอลูมิเนียม
ALUMINIUM PROFILE (PA)**

Material : Aluminium

ITEM NO	LENGTH	PACKING
PROAL-H-06-3	3 M.	

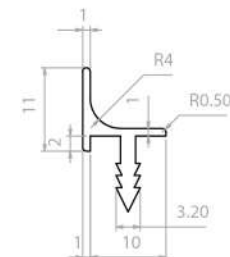

A



NEW PRODUCT

มือจับอลูมิเนียมเหลี่ยมตัว แอลโค้ง
ALUMINIUM PROFILE (PA)

Material : Aluminium

ITEM NO	LENGTH	PACKING
PROAL-H-10-3	3 M.	

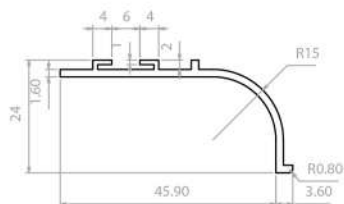

NEW PRODUCT

มือจับอลูมิเนียมเหลี่ยมตัว ซีโค้ง
ALUMINIUM PROFILE (PA)

Material : Aluminium

ITEM NO	LENGTH	PACKING
PROAL-H-10-3	3 M.	

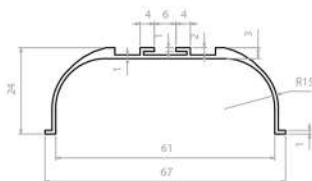

NEW PRODUCT

มือจับอลูมิเนียมเหลี่ยมตัว L
ALUMINIUM PROFILE (PA)

Material : Aluminium

ITEM NO	LENGTH	PACKING
PROAL-H-10-3	3 M.	

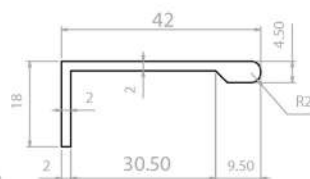

NEW PRODUCT

มือจับอลูมิเนียมเหลี่ยมแบบเฉียง
ALUMINIUM PROFILE (PA)

Material : Aluminium

ITEM NO	LENGTH	PACKING
PROAL-H-10-3	3 M.	

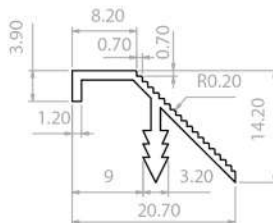



คิ้วอลูมิเนียมแบบฝังไม้ สำหรับงานตกแต่ง

NEW PRODUCT

คิ้วอลูมิเนียมตัวที T-SHAPE ALUMINIUM (PA)

Material : Aluminium



ALSDF-8258-3

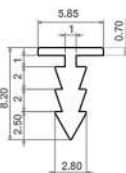

ALSDF-1009-3

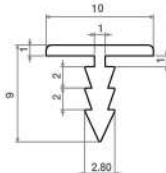

ALSDF-1509-3

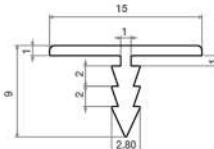

ALSDF-2009-3

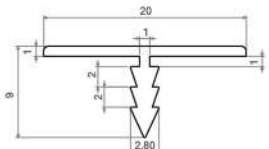

ITEM NO	DIMENSION	LENGTH	PACKING
ALSDF-8258-3	5.85x8.2x0.70 mm.	3 M.	
ALSDF-1009-3	10x9x1.0 mm.	3 M.	
ALSDF-1509-3	15x9x1.0 mm.	3 M.	
ALSDF-2009-3	20x9x1.0 mm.	3 M.	

NEW PRODUCT

คิ้วอลูมิเนียม รุ่นมีปีก 1 ข้าง

T-SHAPE ALUMINIUM WITH FLANGE (PA)

Material : Aluminium



PROAL-T-01-3

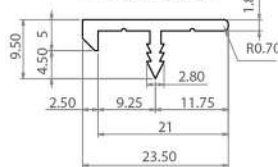

PROAL-T-02-3

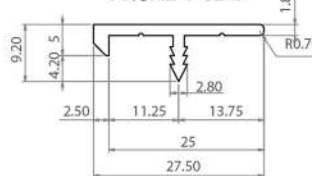

PROAL-T-03-3

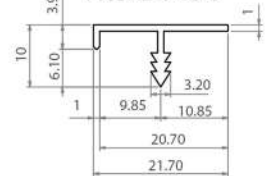

ITEM NO	DIMENSION	LENGTH	PACKING
PROAL-T-01-3	23.5x9.5x1.8 mm.	3 M.	
PROAL-T-02-3	27.5x9.2x1.8 mm.	3 M.	
PROAL-T-03-3	21.7x10x1.0 mm.	3 M.	

NEW PRODUCT

คิ้วอลูมิเนียม รุ่นมีปีก 2 ข้าง

T-SHAPE ALUMINIUM WITH DOUBLE FLANGES (PA)

Material : Aluminium



PROAL-T-04-3

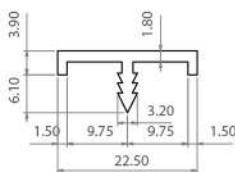

PROAL-T-05-3

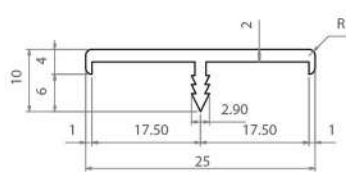

PROAL-T-06-3

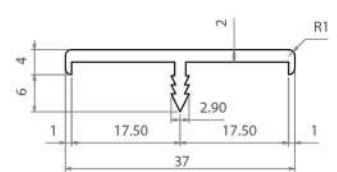

ITEM NO	DIMENSION	LENGTH
PROAL-T-04-3	22.5x10x1.5 mm.	3 M.
PROAL-T-05-3	25x10x1.0 mm.	3 M.
PROAL-T-06-3	37x10x1.0 mm.	3 M.
PROAL-T-07-3	47x10x1.0 mm.	3 M.

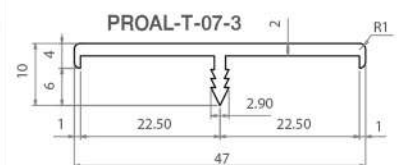

A

NEW PRODUCT

คิ้วอลูมิเนียม ตัวยู U SHAPE ALUMINIUM (PA)

Material : Aluminium

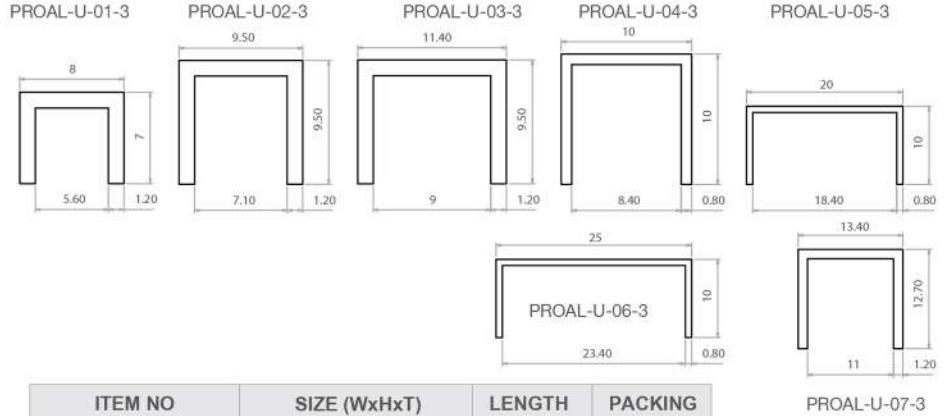

ITEM NO	SIZE (WxHxT)	LENGTH	PACKING
PROAL-U-01-3	7x8x1.2 mm.	3 M.	
PROAL-U-02-3	9.5x9.5x1.2 mm.	3 M.	
PROAL-U-03-3	9.5x11.4x1.2 mm.	3 M.	
PROAL-U-04-3	10x10x0.8 mm.	3 M.	
PROAL-U-05-3	10x20x0.8 mm.	3 M.	
PROAL-U-06-3	10x25x0.8 mm.	3 M.	
PROAL-U-07-3	12.7x13.4x1.2 mm.	3 M.	

NEW PRODUCT

คิ้วอลูมิเนียม ตัวยู แบบมีปีก U SHAPE ALUMINIUM (PA)

Material : Aluminium

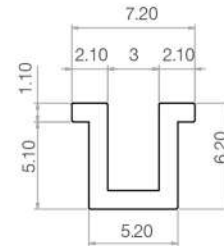

ITEM NO	SIZE (WxHxT)	LENGTH	PACKING
PROAL-U-08-3	7.2x6.2x1.1 mm.	3 M.	

NEW PRODUCT

อลูมิเนียมแบบแผ่น (ใช้กาวติด) FLAT ALUMINIUM (PA)

Material : Aluminium

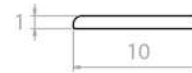

ITEM NO	THICKNESS	LENGTH	PACKING
ALSDF-1001-3	1 MM.	3 M.	

NEW PRODUCT

ฉากอลูมิเนียม ตัวยแอล (สำหรับตกแต่งมุมขอบเฟอร์นิเจอร์) L SHAPE ALUMINIUM (PA)

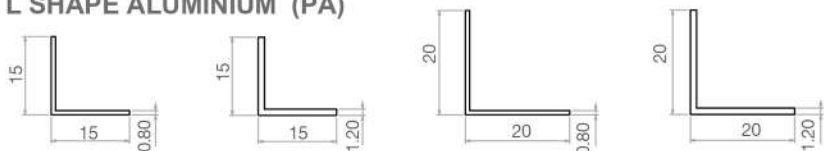

ITEM NO	SIZ (WxHxT)	LENGTH
PROAL-L-15151-3	15x15x0.8 mm.	3 M.
PROAL-L-15152-3	15x15x1.2 mm.	3 M.
PROAL-L-20201-3	20x20x0.8 mm.	3 M.
PROAL-L-20202-3	20x20x1.2 mm.	3 M.
PROAL-L-25251-3	25x25x0.8 mm.	3 M.
PROAL-L-25252-3	25x25x2 mm.	3 M.

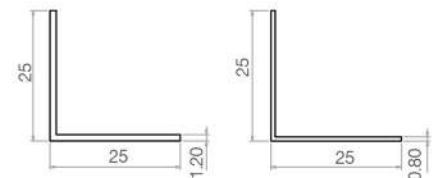

เฟรม อลูมิเนียมระบบน็อคดาวน์ ALUMINIUM FRAME (KNOCKDOWN SYSTEM)

ชุดบานเฟรมอลูมิเนียมสำเร็จรูปเป็นชุดที่ประกอบเป็นบานตู้กระจกอลูมิเนียม แบบน็อคดาวน์โดยการตัดขอบอลูมิเนียม เป็นมุมฉาก 45 องศาแล้วประกบกันเป็นบานโดยใช้ตัวเชื่อมเข้ามุมยึดอีกที ข้อดีของการติดตั้งบานอลูมิเนียมระบบน็อคดาวน์ - มีหลายแบบให้เลือกใช้ - การเข้ามุมสะดวกรวดเร็ว และแน่นอนหนา เพราะใช้ระบบล็อคแบบสอดแล้วใช้สกรู - ชันอัดให้แน่นจึงแน่นกว่าแบบเดิมที่ใช้แผ่นเหล็กอัด เพราะบางครั้งรางอลูมิเนียมจะเล็กใหญ่ จึงทำให้โยกได้

KNOCK DOWN SLIDE SYSTEM

ติดตั้งโดยไม่ต้องเจาะอลูมิเนียม



Material : Aluminium
 Finish : Custom (Anodize) *สามารถเลือกสีชุบได้
 การใช้งาน : เหมาะสำหรับใช้ประกอบเป็นบานตู้ครัว
 การติดตั้ง : ใช้ร่วมกับบานพับด้วยรุ่นพิเศษ โดยไม่ต้องเจาะด้วย

1. ชุดเฟรมอลูมิเนียม รุ่นขอบบาง (น็อคดาวน์) ALUMINIUM FRAME CABINET DOOR (PA)

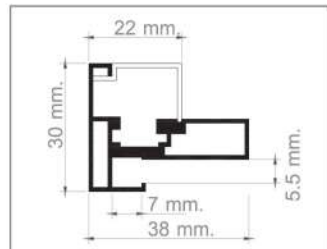

ITEM NO	เฟรมอลูมิเนียม ความยาว 3 เมตรระบบน็อคดาวน์
AL-194-3	สำหรับกระจกหนา 5 มม.

2. ชุดเฟรมอลูมิเนียม รุ่นขอบ 28 มม. (น็อคดาวน์) ALUMINIUM FRAME CABINET DOOR (PA)

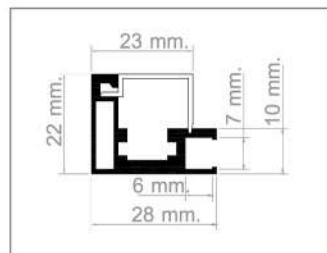

ITEM NO	เฟรมอลูมิเนียม ความยาว 3 เมตร ระบบน็อคดาวน์
AL-392-3	สำหรับกระจกหนา 5 มม.

อุปกรณ์สำหรับการติดตั้ง / ACCESSORIES

PICTURE	ITEM NO	DRAWING	LENGTH
	PDM-90T ตัวยึด เข้ามุม 90 องศา		
	PDM-013T ฝาปิดพลาสติก สำหรับปิดร่องอลูมิเนียม		2.50 m.
	ALSP-20 ยางรอง สำหรับกระจกหนา 5 มิล		3 M.
 ADAM-371 ชาตรง	 ADAM-372 ชากลาง	 ADAM-373 ชางอ	บานพับด้วยรุ่นพิเศษ ระบบ Insert ในราง - ไม่ต้องเจาะด้วย - ปรับเลื่อนตำแหน่งได้

A

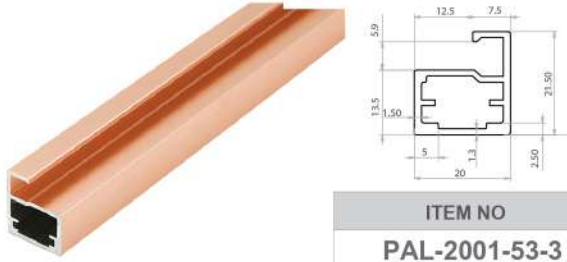

ITEM NO
PAL-2001-53-3
เฟรมข้าง ความยาว 3 เมตร สำหรับกระจกหนา 5 มม.

**ชุดอุปกรณ์บานเฟรมอลูมิเนียม
รุ่น กรอบกว้าง 20 มม.**

ALUMINIUM FRAME 20 MM. (PA)

Material : Aluminium
Finish : Custom (Anodize)*สามารถเลือกสีชุบได้
การใช้งาน : ใช้ประกอบเป็นบานตู้พร้อมมือจับ
เช่น บานตู้เสื้อผ้า, บานตู้ครัว เป็นต้น
การติดตั้ง : ใช้ร่วมกับบานพับด้วยรุ่น 20 มม.

* (สามารถเลือกสีที่จะชุบได้ที่หน้า A47)



เฟรมมือจับอลูมิเนียม รุ่น กรอบกว้าง 20 มม. HANDLE ALUMINIUM FRAME 20 MM. (PA)

* ใช้จับคู่ร่วมกับเฟรมข้าง รหัส PAL-2001-53-3

PICTURE	ITEM NO	DRAWING	LENGTH
	PAL-2002-50-3 เฟรมมือจับอลูมิเนียมกรอบ 20 มิล		3 M.
	PAL-2003-51-3 เฟรมมือจับอลูมิเนียมกรอบ 20 มม.		3 M.
	PAL-2004-52-3 เฟรมมือจับอลูมิเนียมกรอบ 20 มิล		3 M.

ชุดอุปกรณ์บานเฟรมอลูมิเนียม กรอบกว้าง 20 มม. รุ่นขอบบางพิเศษ (PA)

* สำหรับรุ่นนี้การติดตั้งกระจกต้องใช้กาว ซิลิโคนสำหรับยิงงานกระจก



ITEM NO
PAL-2005-49-3
เฟรมข้าง รุ่นขอบบางพิเศษ ความยาว 3 เมตร



ITEM NO
PAL-2006-50-3
เฟรมมือจับรุ่นขอบบางพิเศษ ความยาว 3 เมตร

* ใช้จับคู่ร่วมกับเฟรมข้าง รหัส PAL-2005-49-3

อุปกรณ์สำหรับการติดตั้ง / ACCESSORIES

	PALCORNER-20 ฉากเหล็กเข้ามุมเฟรมอลูมิเนียม รุ่นกรอบกว้าง 20 มม.		37.8x32.2x16 MM.
	JF-408W-POL100 สกรู M4x8 MM. สำหรับใช้ยึดฉากเหล็กเข้ามุม		ความยาว 8 MM. บรรจุ / PACKING 100 Pcs. / ถุง
	ALSP-20 ยางรอง สำหรับกระจกหนา 5 มิล		3 M.
	ADM-02G09 บานพับด้วยรุ่น 20 มิล 3D ขาดตรง CLIP ON - SOFT CLOSE		

เฟรม อลูมิเนียมกรอบ 45 มม. ALUMINIUM FRAME 45 MM.

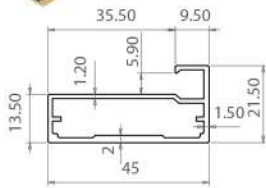

ชุดอุปกรณ์บานเฟรมอลูมิเนียม
รุ่น กรอบกว้าง 45 มม.

ALUMINIUM FRAME 45 MM. (PA)

Material : Aluminium

Finish : Custom (Anodize) *สามารถเลือกสีชุบได้

การใช้งาน : ใช้ประกอบเป็นบานตู้พร้อมมือจับ

เช่น บานตู้เสื้อผ้า , บานตู้ครัว เป็นต้น

การติดตั้ง : ใช้ร่วมกับบานพับด้วยหรือลูกกลิ้งบานเลื่อน



ITEM NO	DESCRIPTION
PAL-4501-63-3	เฟรมข้าง กรอบกว้าง 45 มม. ความยาว 3 เมตร

เฟรมมือจับอลูมิเนียม รุ่น กรอบกว้าง 45 มม. HANDLE ALUMINIUM FRAME 45 MM. (PA)

* ใช้จับคู่ร่วมกับเฟรมข้าง รหัส AL55-3

PICTURE	ITEM NO	DRAWING	LENGTH
	PAL-4502-36-3 เฟรมมือจับอลูมิเนียมกรอบ 45 มิล		3 M.
	PAL-4503-73-3 เฟรมมือจับอลูมิเนียมกรอบ 45 มิล		3 M.
	PAL-4504-34-3 เฟรมมือจับอลูมิเนียมกรอบ 45 มิล		3 M.
	PAL-4505-67-3 เฟรมมือจับอลูมิเนียมกรอบ 45 มิล		3 M.
อุปกรณ์สำหรับการติดตั้ง / ACCESSORIES			
	SYWSA-0001 ฉากเหล็กเข้ามุมเฟรมอลูมิเนียม		42x62 MM.
	JF-410W-POL100 สกรู M4x10 mm. สำหรับใช้ยึดฉากเข้ามุม		10 MM. (บรรจุ 100 ตัว)
	ALSP-20 ยางรอง สำหรับกระจกหนา 5 มิล		3 M.

เฟรม อลูมิเนียมกรอบ 45 มม. ALUMINIUM FRAME 45 MM.

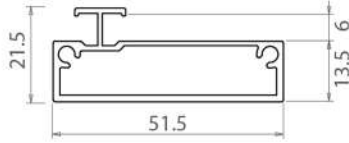
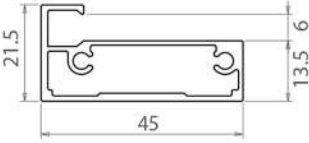

ITEM NO
AL55-3
เฟรมข้าง ความยาว 3 เมตร สำหรับกระจกหนา 5 มม.

ITEM NO
AL27-3
ตัวแบ่งเฟรม ต่อกกลาง ความยาว 3 เมตร

ชุดอุปกรณ์บานเฟรมอลูมิเนียม
รุ่นต่อกกลาง สำหรับบานตู้สูง กรอบกว้าง 45 มม.
ALUMINIUM FRAME 45 MM. (PA)

Material : Aluminium
Finish : Custom (Anodize) *สามารถเลือกสีชุบได้
การใช้งาน : ใช้ประกอบเป็นบานตู้สูงพร้อมมือจับ
เช่น บานตู้เสื้อผ้า , บานตู้ครัว เป็นต้น
การติดตั้ง : ใช้ร่วมกับบานพับด้วยหรือลูกล้อบานเลื่อน

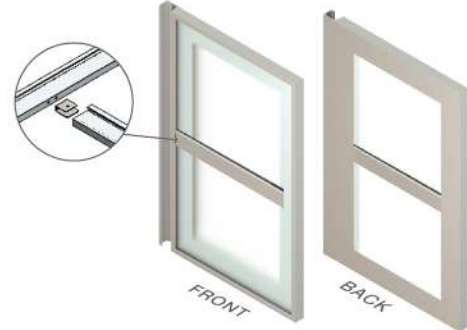

เฟรมมือจับอลูมิเนียม รุ่น กรอบกว้าง 45 มม. (PA)

* ใช้จับคู่ร่วมกับเฟรมข้าง รหัส AL55-3 และ เฟรมต่อกกลาง รหัส AL27-3

PICTURE	ITEM NO	DRAWING	LENGTH
	PAL-4502-36-3 เฟรมมือจับอลูมิเนียมกรอบ 45 มิล		3 M.
	PAL-4503-73-3 เฟรมมือจับอลูมิเนียมกรอบ 45 มิล		3 M.
	PAL-4504-34-3 เฟรมมือจับอลูมิเนียมกรอบ 45 มิล		3 M.
	PAL-4505-67-3 เฟรมมือจับอลูมิเนียมกรอบ 45 มิล		3 M.

อุปกรณ์สำหรับการติดตั้ง / ACCESSORIES

	SYWSA-0001 ฉากเหล็กเข้ามุมเฟรมอลูมิเนียม		42x62 MM.
	JF-410W-POL100 สกรู M4x10 mm. สำหรับใช้ยึดฉากเข้ามุม		10 MM. (บรรจุ 100 ตัว)
	SYWSA-0002 ตัวรับเฟรมกลาง		
	ALSP-20 ยางรอง สำหรับกระจกหนา 5 มิล		3 M.

บานพับก๊วย 35 มิล
รุ่น SLIDE ON SOFT CLOSE
CONCEALED HINGE (IM)



วัสดุ : เหล็ก
 ขนาด : T x L x H 11.3 x 3 x 75 มม.
 องศา : เปิด 100 องศา
 ขนาดก๊วย : 35 มม.
 ระยะเจาะ : 11.3 มม.

บานพับก๊วย 35 มิล
รุ่น 3D CLIP ON SOFT CLOSE
CONCEALED HINGE (IM)



วัสดุ : เหล็ก
 ขนาด : T x L x H 11.3 x 3 x 75 มม.
 องศา : เปิด 100 องศา
 ขนาดก๊วย : 35 มม.
 ระยะเจาะ : 11.3 มม.



ชุดอุปกรณ์บานเลื่อนสำหรับบานเฟรมอลูมิเนียม SLIDING DOOR FITTING FOR ALUMINIUM FRAME DOOR

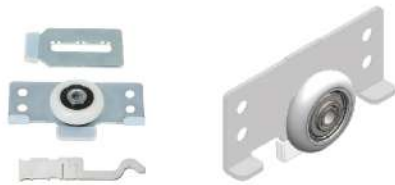

SDF-1000W

ชุดอุปกรณ์บานเลื่อน ลูกล้อกลม ว่างรางล่าง

60 KGS.

ROUND WHEEL SLIDING FOR ALUMINIUM FRAME DOOR (PA)

ลูกล้อสีขาว
 รุ่นพิเศษสำหรับเฟรมอลูมิเนียม

การใช้งาน :

1. สำหรับบานสไลด์เดี่ยวและสไลด์คู่
2. สามารถรับน้ำหนักได้ถึง 60 กก.
3. สำหรับบานเลื่อนประตูเฟรมอลูมิเนียม

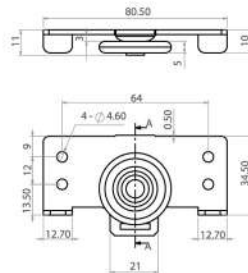

PICTURE	ITEM NO.	DESCRIPTION	MATERIAL	FOR 2 DOORS	REMARK
	SDC-45-02	Bottom Running Wheel ลูกล้อว่างรางล่าง สำหรับเฟรมอลูมิเนียม	Steel เหล็ก	4 Pcs.	
	SD-1000-02	Upper Glide ไกด์บานเลื่อนบน	Steel เหล็ก	4 Pcs.	
	SD-1000-03	Stopper ตัวหยุดบาน รุ่นสูง	Plastic พลาสติก	2 Pcs.	
	SD-1000-04	Stopper ตัวหยุดบาน รุ่นต่ำ	Plastic พลาสติก	2 Pcs.	
	 AL-1000-10-6	รางอลูมิเนียม / Aluminium Track Bottom Track 10.2 mm. รางรุ่นต้น 10.2 mm	Aluminium อลูมิเนียม	6 M.	Not in Set
	 AL-1000-15-6	Bottom Track 15 mm. รางรุ่นต้น 15 mm	Aluminium อลูมิเนียม	6 M.	Not in Set

ตารางสีชุบ Anodize เฟรมอลูมิเนียม เส้นยาว 3 เมตร

สีชุบ (FINISH)	รหัส CODE	รายละเอียด (DESCRIPTION)
1. 	MSV	สีเงิเงากระจก MIRROR GLOSS SILVER *(ใช้แทนสีโครเมียม)
2. 	GSV	สีเงิเงา GLOSS SILVER
3. 	LGR	สีเทาอ่อน LIGHT GREY
4. 	LBR	สีน้ำตาลอ่อนพสีชา LIGHT BROWN
5. 	DB * STANDARD COLOR	สีน้ำตาลเข้ม DARK BROWN
6. 	PG * STANDARD COLOR	สีชมพูทอง PINK GOLD
7. 	CG * STANDARD COLOR	สีทองแชมเปญ CHAMPAGNE GOLD
8. 	GF	สีกราไฟท์ GRAPHITE
9. 	GB * STANDARD COLOR	สีดำเงา GLOSS BLACK
10. 	MB	สีดำด้าน MATT BLACK

ข้อกำหนดเรื่องการชุบสีเฟรมอลูมิเนียม

- สีจริงจะดรอปจากรูปภาพในแคตตาล็อก
- งานชุบสีแต่ละ Lot สีที่ได้จะไม่เหมือนกัน หากต้องการ ใช้จำนวนเยอะ แนะนำให้สั่งมาใน Lot เดียวกัน
- หากสั่งสีแบบเดิมในรอบใหม่ ต้องนำตัวอย่างสีมาเทียบใหม่ทุกครั้ง เพราะสีในแต่ละ Lot จะไม่เหมือนเดิม
- ควรตรวจเช็คสีน้ด้าก่อนการใช้งานจริง หากมีปัญหาสามารถเคลมสีน้ด้าได้ภายใน 7 วัน