



THAI POLYMER SUPPLY

- ⚙️ **ENGINEERING PLASTICS**
- ⚙️ **CONVEYOR & COMPONENT**
- ⚙️ **PRINTER**
- ⚙️ **FLUID SYSTEMS**
- ⚙️ **AIR SUPPLY**
- ⚙️ **INSULATION**



WE OFFER HIGH QUALITY PRODUCTS AND SERVICE TO SATISFY YOUR NEED.

HISTORY

In the year 1982 Thai Polymer Supply Co.,Ltd was established as an Engineering Plastics importer located at 406 Sukhumvit55 (Soi Thonglor) Sukhumvit Rd., Klongton Nue, Wattana, Bangkok 10110 with the capital 49 million baht.

At the present time, we are the leading engineering plastics importer in Thailand with the capital 200 million baht , 16 buildings (used area more than 8,640 s.q.m.) with the support from our 700 staff. The sales more than 1,300 million baht per year.

We are committed to meet the needs of our customers and to continually strive to offer them better solutions to the engineering plastics problems and to give technical support for the wide range of products that our sub-companies provide. We have 13 branches through out Thailand to better serve the need to our customers. We have also divided our company into six marketing divisions to be more specific with our product range as follows :-

- Engineering Plastics
- Conveyor Component
- Printer
- Fluid Systems
- Air Supply
- Insulation

Our product range is sourced from Asia, Europe, North America and South Africa, based on quality and the customer requirements. Most of the supplied products are the brand leaders in their fields. We have extensive warehouse facilities enabling us to carry the stocks to meet our customer's need. We have in house machining facilities and test R&D department. We work as a team providing the best solutions for our customers with quality products and services to meet the customer need. We are continually upgrading the knowledge of our sales team with the latest information and technology. The inspiring vision behind Thai Polymer Supply's success still remains unchanged and will always be.

“YOUR SATISFACTION, OUR SERVICE”

BRANCH

THAI POLYMER SUPPLY BRANCH

1. Rayong Branch
2. Leam Chabang Branch
3. Prachuap Khiri Khan Branch
4. Hatyai Branch
5. Surat Thani Branch
6. Khon Kaen Branch
7. Nakhon Ratchasima Branch
8. Sara Buri Branch
9. Nakornpathom Branch
10. Chiang Mai Branch
11. Navanakorn Branch
12. Prachinburi Branch
13. Samut Sakhon Branch

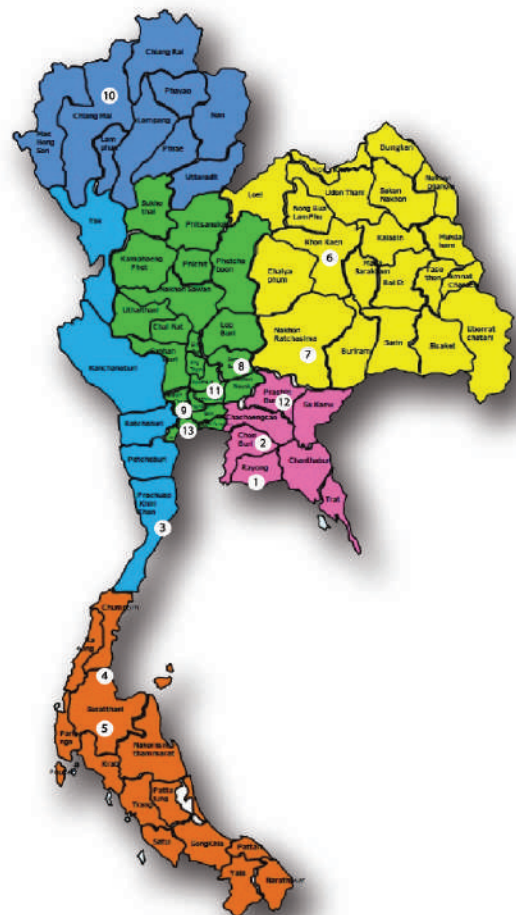

ENGINEERING PLASTICS

- Engineering Plastics.
- Advance Engineering Plastics.
- We machine finish to our specification.

TEL : 02-750-4852-8 #102-109 FAX : 02-312-1781

Email : plastics@thaipolymer.co.th

Material Plastics

GENERAL PLASTICS

- PA6 (Nylon)
- PA66
- Cast Nylon, MC Nylon
- POM (PomC, PomH, AF, GF20%)
- PET-P สีขาว
- PC (Clear, Black)
- PET (Clear)
- PP (White, Natural, Grey)
- HDPE (PE300)
- UHMWPE (PE1000) สีนํ้าเงิน, เหลือง, เทา, ขาว, เขียว
- PVC (Grey, Clear)
- ABS

STATIC CONTROL PLASTICS

- Pomalux (SD-A, CN-F)
- Semitron ESD (225, 420, 410, 480)
- MC501 (R2, R6, R11, R9)
- PE1000 ESD (Polyslick502, Tivar1000ESD)
- PEEK CNT, PEEK W5000CNT
- PEEK ESD (PEEK CA30, PEEK MOD)
- TAKIRON (PVC ESD, PC ESD, FM Grade)
- Epoxy ESD, Bakelite ESD
- CDM ESD (Black, Grey)

HIGH PERFORMANCE PLASTICS

- PEI (Ultem1000, 2300)
- PEEK (Virgin, Carbon30%, GF30%)
- PAI (Torlon4203, 4301, 5530)
- PPS (Virgin, GF40%)
- PI (Vespel SP-1, SP-21, SP-22, SP-211)
- PBI
- Turcite TA, Turcite TX
- Unilate (Brown, Black, White)

CHEMICAL RESISTANCE PLASTICS

- PTFE (Virgin, Carbon25%, 32%, Glass25%)
- PTFE Rulon, PTFE Bronze
- PSU, PPSU
- PVDF
- PCTFE
- ECTFE
- ETFE
- FEP
- PFA

MEDICAL PLASTICS

- POM Medical Grade
- PE1000 Medical Grade
- PPSU Medical Grade



POLYETHYLENE FOAM (PE FOAM)

DURAWOOD / AICELLWOOD 40 / AICELLWOOD CONDUCTIVE

แผ่นโฟมโพลีเอทิลีน (PE FOAM) ถูกนำมาใช้เป็นวัสดุป้องกันในการขนส่งในอุตสาหกรรมชิ้นส่วนยานยนต์ เพื่อทดแทนแผ่นพลาสติกลูกฟูก แผ่นไม้อัด และแผ่นขึ้นรูป PE ทั่วไป และสามารถนำมาใช้เป็นวัสดุกันกระแทก ในอุตสาหกรรมอื่นๆ ได้อย่างมีประสิทธิภาพ

• DURAWOOD

รับน้ำหนักได้ดี ทนต่อสารเคมี ผิวสัมผัสไม่แข็งกระด้าง
Chemical Resistance Excellent Hardness

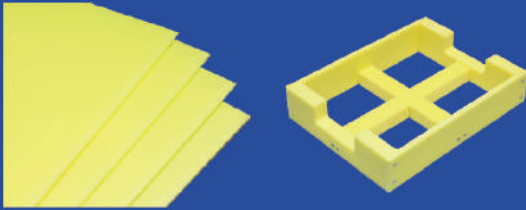

• AICELLWOOD 40

น้ำหนักเบา แข็งแรงไม่แตกหัก ไม่ดูดซับน้ำ น้ำมัน
Light Unbreakable Not Adsorption

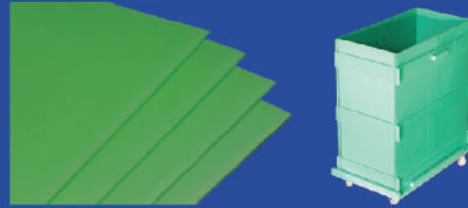

• AICELLWOOD CONDUCTIVE

ไม่เป็นตัวนำไฟฟ้า ไม่เกิดไฟฟ้าสถิต ขึ้นรูปได้ง่าย
Surface Resistivity Spectrum From 10K to 10M

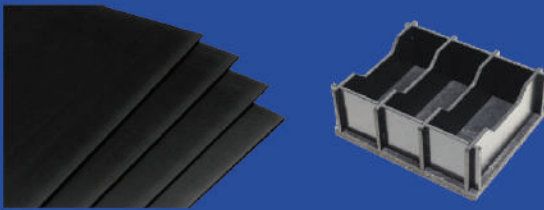

• POLYPROPYLENE (PP FOAM)

น้ำหนักเบา/นุ่ม นิยมใช้แทน Future Board

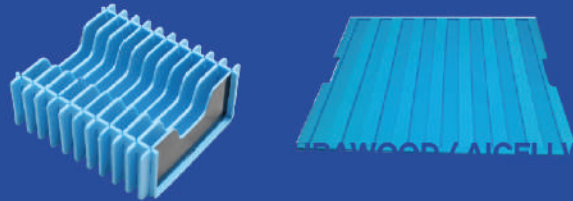

STOCK & MACHINERY

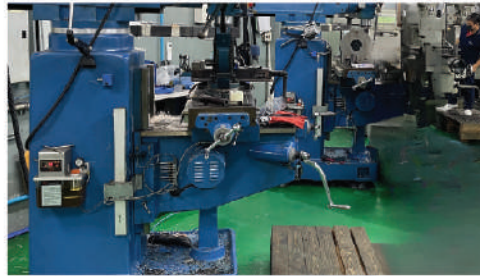



HIGH PERFORMANCE POLYURETHANE

- PU 15-95 Shore A , PU 75 Shore D
- Rod, Tube and Sheet
- Machining part
- Fork-Lift tyres
- Heavy duty caster wheels
- Screening for Mining and Cement industry
- Bushes, Bearing, Flexible coupling
- Moulds for concrete
- Roller
- Made to order

MINING

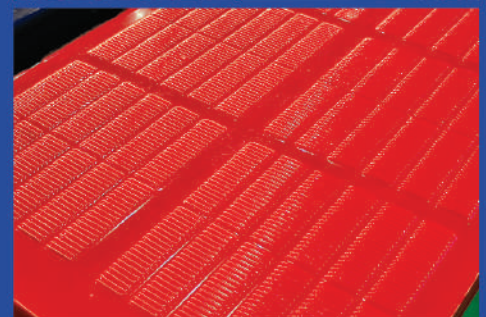
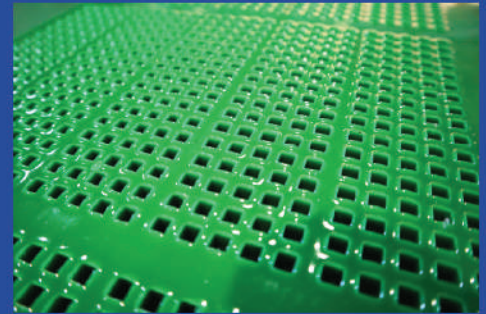

EXAMPLE

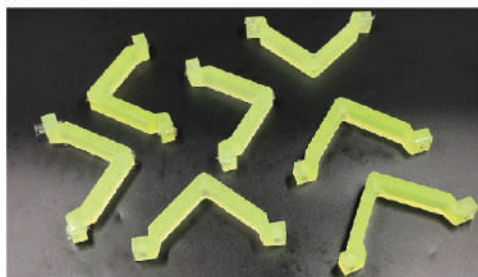
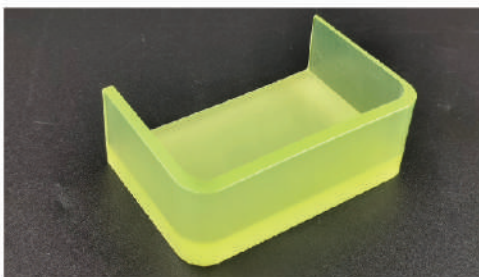

PTFE - GLASS FABRIC TAPE AND BELTS

T APE

PTFE Coated glass fabric tape | เทปกั้นความร้อน โยแก้วเคลือบ PTFE

High heat-resistant adhesive tape with excellent mechanical strength and release properties based on PTFE coated glass fabric
Can be used continuously from -73°C to $+260^{\circ}\text{C}$. And can be used up to

B ELT

PTFE Coated glass fabric Belts | สายพานตาข่าย

PTFE belts that can withstand high process temperatures.
These are used in various industries for drying, and transfer line operations.

F ABRIC

สายพานลำเลียง, สายพานซิลปากกุง, แผ่นรองอบ รองซีล

PTFE belts that can withstand high process temperatures.
These are used in various industries for drying, and transfer line operations.

S ILICONE

Silicone steam mat ซิลิโคนสัมผัสอาหาร และ Silicone PTFE Glass

FOOD APPLICATION



Fusing Press Belt

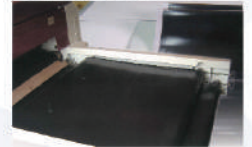

Dryer Belt

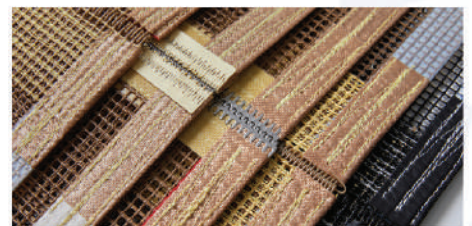
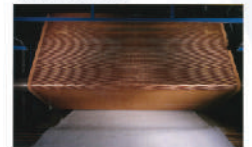

สายพาน อุตสาหกรรม

ผู้นำเข้า และตัวแทนจำหน่าย
สายพานคุณภาพสูงจากต่างประเทศ
บริการติดตั้งสายพานทั้งใน และนอกสถานที่ โดยช่างผู้ชำนาญการ

- PU HEAT RESISTANT
- CONVEYOR BELTS
- FOOD BELTS
- TIMING BELTS
- ROUND BELTS
- STANLESS BELTS
- FILTER BELTS

TPS BELT

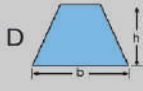
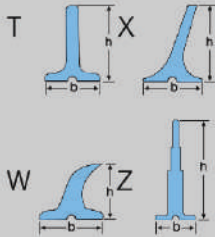
	Cross Section	Material	Type
Guide		PVC	D6
			D8
			D10
		PU	D13
			D17
			D22
Cleat		PVC	T10
			T20
			T30
			T40
			T50
			T60
	PU	W35	
		X50	
		X60	
		X80	
		T20	
		T30	
T120			

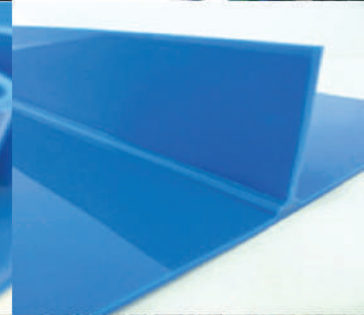
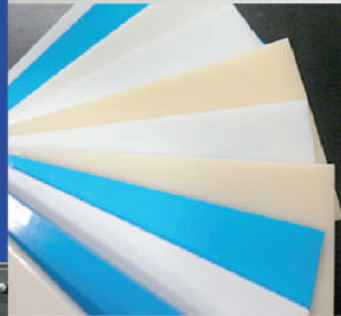

CONVEYOR COMPONENT



KÖBO
The Chain People

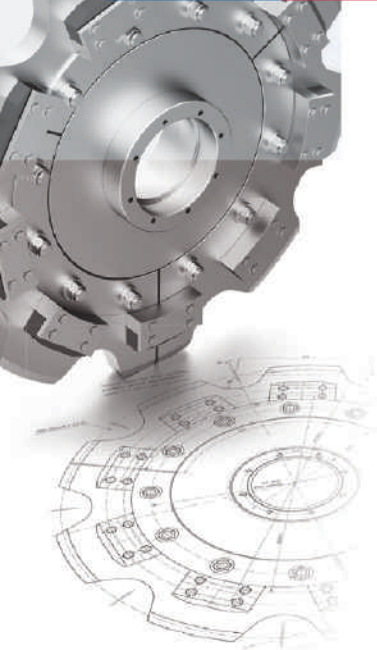

Working hand in hand with the **FOOD INDUSTRY**

BEVERAGE AND BOTTLING
QUALITY IS A MATTER OF EXPERIENCE.

TROUGH CONVEYOR CHAINS
SIMPLE AND RELIABLE QUALITY.

STERILIZER CHAINS
STATE-OF-THE-ART RELIABILITY.

SLAUGHTERHOUSE CHAIN TECHNOLOGY
CLEANER SOLUTIONS MADE BY KÖBO.

SPROCKETS

SETTING YOUR BUSINESS IN MOTION. _____, BUSINESS KEEPS ON MOVING.



Wire Mesh

Contact:

Tel: 02-750-4852-8, 02-730-1240-7 #163-172

E-mail: conveyor@thaipolymer.co.th

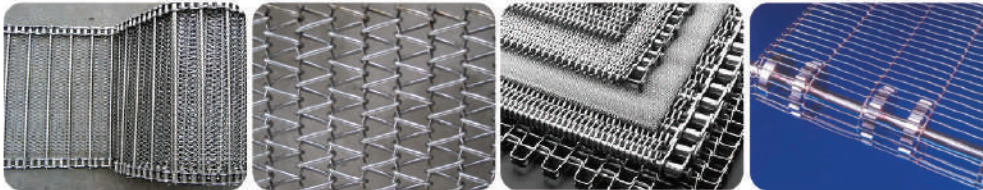

Example



SYSTEM PLAST™



Interactive catalog
connection

- Our range
- Stainless steel flat top chains
- Plastic resin flat top chains
- Chains with friction surface
- Chains with accumulation rollers
- Gripper chains
- Multiflex chains
- Dual magnetic corner tracks
- Modular belts
- Drive sprockets
- Idler wheels
- Corner discs
- Component



Tel: 02-750-4852-8, 02-730-1240-7 #163-172
E-mail: conveyor@thaipolymer.co.th



**CONVEYOR
COMPONENT**

FREDRIKSONS
CONVEYOR SOLUTIONS

Chain advantages

- Fredriksons
- Lower COF
- Longer lifetime
- Low mantanace
- Energy saving
- Economical price

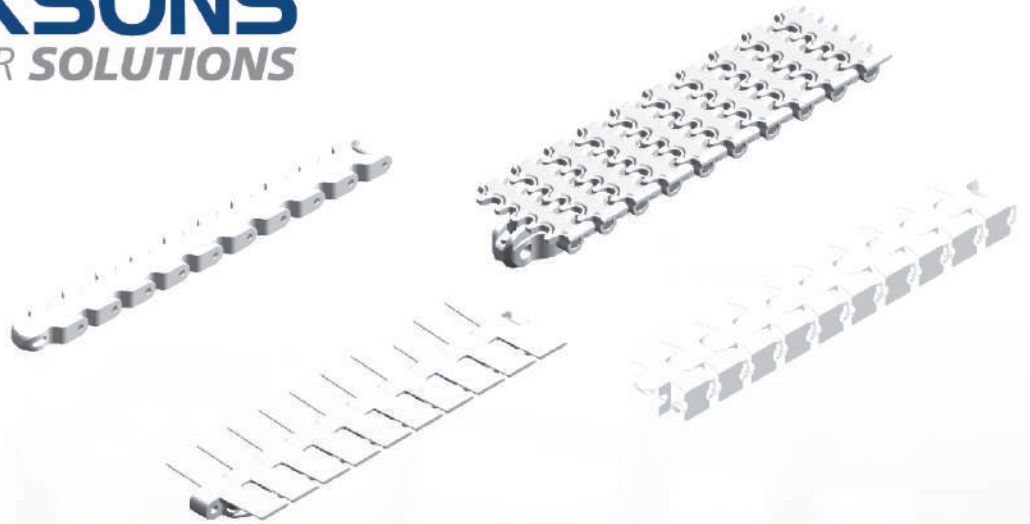

forbo

MOVEMENT SYSTEMS

siegling prolink modular belts



Primary Packaging



Secondary Packaging

Tel: 02-750-4852-8, 02-730-1240-7 #163-172
E-mail: conveyor@thaipolymer.co.th

UX2 Series

Coding & Marking Solutions
Inkjet Printer

HITACHI



RELIABILITY

Highly reliable design and superior construction

EFFICIENCY

Environmentally friendly with low operational costs

EASE OF USE

Simple touchscreen operation with video-based guidance

Tel : 02-312-2560, 02-312-2580

E-mail : inkjet@thaipolymer.co.th

เครื่องพิมพ์วันเดือนปีผลิต บนผลิตภัณฑ์



PRINTER



e-SolarMark

Laser Marking/Coding System on foils, plastics and metals



Laser coding examples



Plastic



PVC



Plastic



Thermo sensitive label



Coated metal



PET

LM Series

- Easy Operation
- Speed & Quality
- Proven Reliability



HITACHI Inspire the Next



Contact:

TEL: 0-2750-4852-8, 0-2312-2021-5 #230, 231
 Email: marking@thaipolymer.co.th

Tiflex High Resolution Printers/Coders

HIGH RESOLUTION ONE OR TWO-COLOR PRINTER

- Economy
- Efficiency
- Reliability



Tel : 02-750-4852-8 # 279,231
 Fax : 02-312-2493
 E-mail : tiflex@thaipolymer.co.th

handyjet HANDY-JET

Integrated system of controller, printhead and inkjet reservoir

PORTABLE MARKING DEVICE

- Marking anywhere without conveyor
- Simple and easy-to-use design
- Genuine HP cartridge that allows marking on any material
- Multilingual menu in Korean, English, Chinese, etc.



Shipyard marking Bag marking Carton Box marking



Paper Bag marking Paper Roll marking



Primer Steel Plate marking



interMAC
 World's best DOD Printer

COGNEX vision >

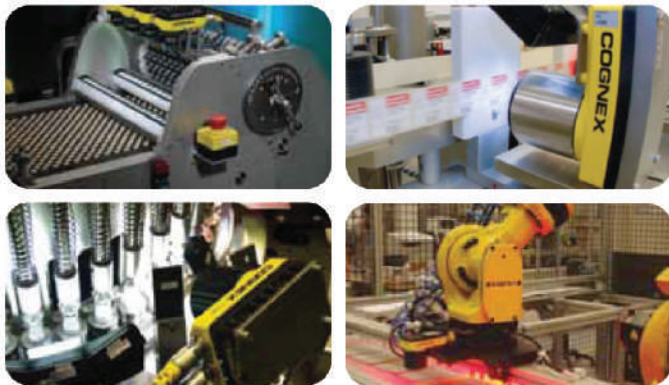

Hitachi Vision System MC-20S

Reduce Production waste by incorporating Hitachi's Vision System with our legendary small character printer.

Hitachi Vision System MC-20S working with Hitachi IJ printer for total marking

Hitachi Vision System

MC-20SW1



A 15.0 inch TFT LCD touch panel display

Dedicated white LED strobe lighting

Vision System unit

Color camera

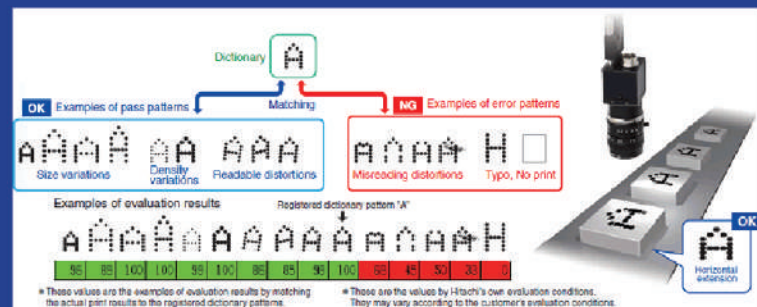

Contact:

TEL : 02-750-4852-8, 02-312-2021-5 #278

Email : machinevision@thaipolymer.co.th

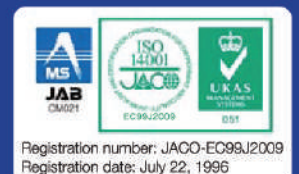

Registration number: JACO-EC99J2009
Registration date: July 22, 1996

HITACHI
Inspire the Next



HITACHI OIL-FREE SCREW COMPRESSOR

OIL FREE SCREW

SINGLE STAGE / TWO STAGE

บีมลม สกรู HITACHI

แบบไม่มีน้ำมันปะปน

ใช้กับลม Oil Free ขนาดตั้งแต่ 15Kw - 580 Kw
เหมาะสำหรับงานอุตสาหกรรมอาหาร อุตสาหกรรม
อิเล็กทรอนิกส์ และอุตสาหกรรมที่ต้องการลมสะอาด

HITACHI OIL-FLOODED screw compressors

HISCREW NEXT II series

บีมลม สกรู HITACHI

แบบใช้น้ำมันหล่อลื่น

ภายใน Oil Flooded ขนาดตั้งแต่ 7.5Kw-250Kw เหมาะสำหรับงาน อุตสาหกรรมทั่วไป



Site work :



OIL FREE
BEBICON



OIL-FLOODED
BEBICON



Spare part :

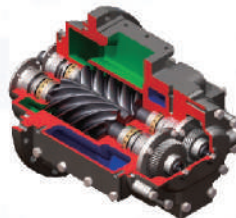

HITACHI NITROGEN GAS GENERATOR

Hitachi PSA Nitrogen Gas Generator N

NEXT series Vtype

2.2kW

3.7/5.5kW



TERAL
Vacuum Pump VFZ/VFC/VFD

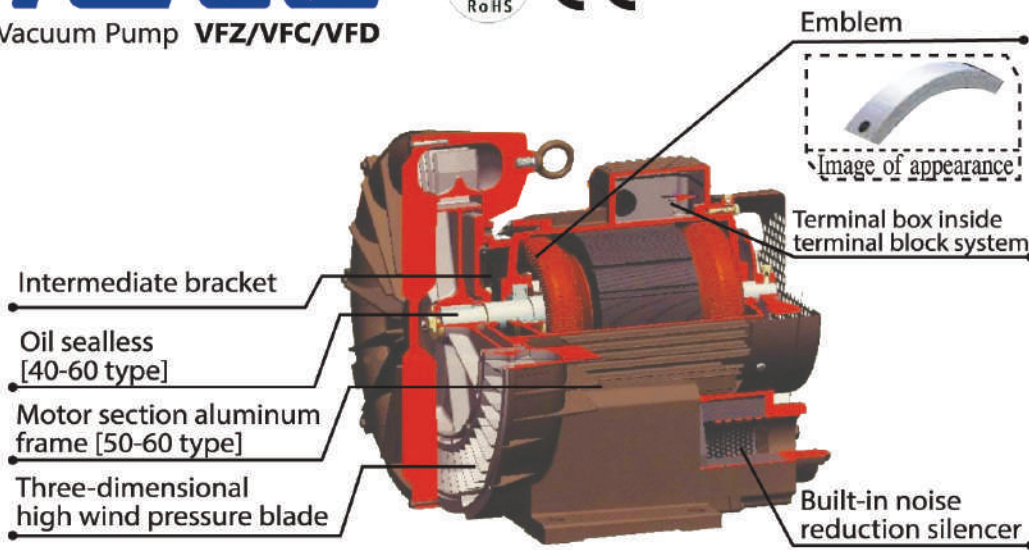

SPECIFICATION

- ⊙ High pressure-max 25.5 kPa
- ⊙ Strong wind-force-maximum 780 m3/h
- ⊙ Single-Phase / 50 Hz / IP 54 / 200 - 220 V / 0.06-1.3 kW
- ⊙ High vacuum-maximum 14.07 kPa
- ⊙ Stable flow volume Low energyloss.
- ⊙ Three-Phase / 50 Hz / IP 54 / 380 - 415 V / 0.06 - 11 kW



Mist Collector

Mistrésa

Application

Manufacturing machinery Other application

Features

Drastically reduces the filter size. Greatly reduces the frequency and length of maintenance work. Drastically reduces waste. Superior motor performance Easy, safe maintenance Also effective on dust included in the mist Clogging check at a glance Easy drain piping

Also collects dust contained in mist

Mist (Dust) Compatible Series, CRD Type



Mist(Dust) Compatible Series, Type



Long-term maintenance - free type

Filterless Series, CRN Type



Enabled to collect high-temperature mist generated by component cleaning machines

High Temperature Mist Compatible Series, CRH Type



High air volume type enabled for an open-type machining center

High Air Volume, CRL Type





wilo



MHI



Star-RS



Top-S



MHIL

Worldwide premium-brand

All application :

- heating water
- air-conditioning
- cooling water
- water supply
- sewage disposal
- waste water



MVI



Vertical Turbine



Helix



Rexa Pro



IL



Multi-Stage Pumps



BL



NL



SCP



Booster Set



STS



TWI



FA



TR

Contact:

Tel: 02-750-4852-8, 02-312-2021-5 #216, 285

Fax: 02-730-1257

E-mail: salespump@thaipolymer.co.th

ปั๊มน้ำอุตสาหกรรม การประปา และกรมชลประทาน

MAGNETIC DRIVING PUMP

All application :

- Chemical Solution
- Sea Water
- Water Circulation & Transfer



Made In Japan



PMD 4033
PMD 7533



PMD 641
PMD 1561 PMD 2571



PMD 371

FLUID SYSTEM

Control Valves

- Pnuematic, Electric, Pnuematie Diaphragm
- Gate, Globe, Butter Fly, Ball, Knife Gate



KSB Valves Rang Manual Valves

- Gate-Globe-Check (DIN/ANSI)
- Butterfly (KSB AMRI)
- Diaphragm (KSB SISTO)
- Ball
- Knife Gate

CONTACT :

Tel : 02-750-4852-8#214-215

Fax : 02-730-1257

E-mail : pump@thaipolymer.co.th



Industrail Pressure Hoses for Factory Pipe Line & Machine Parts

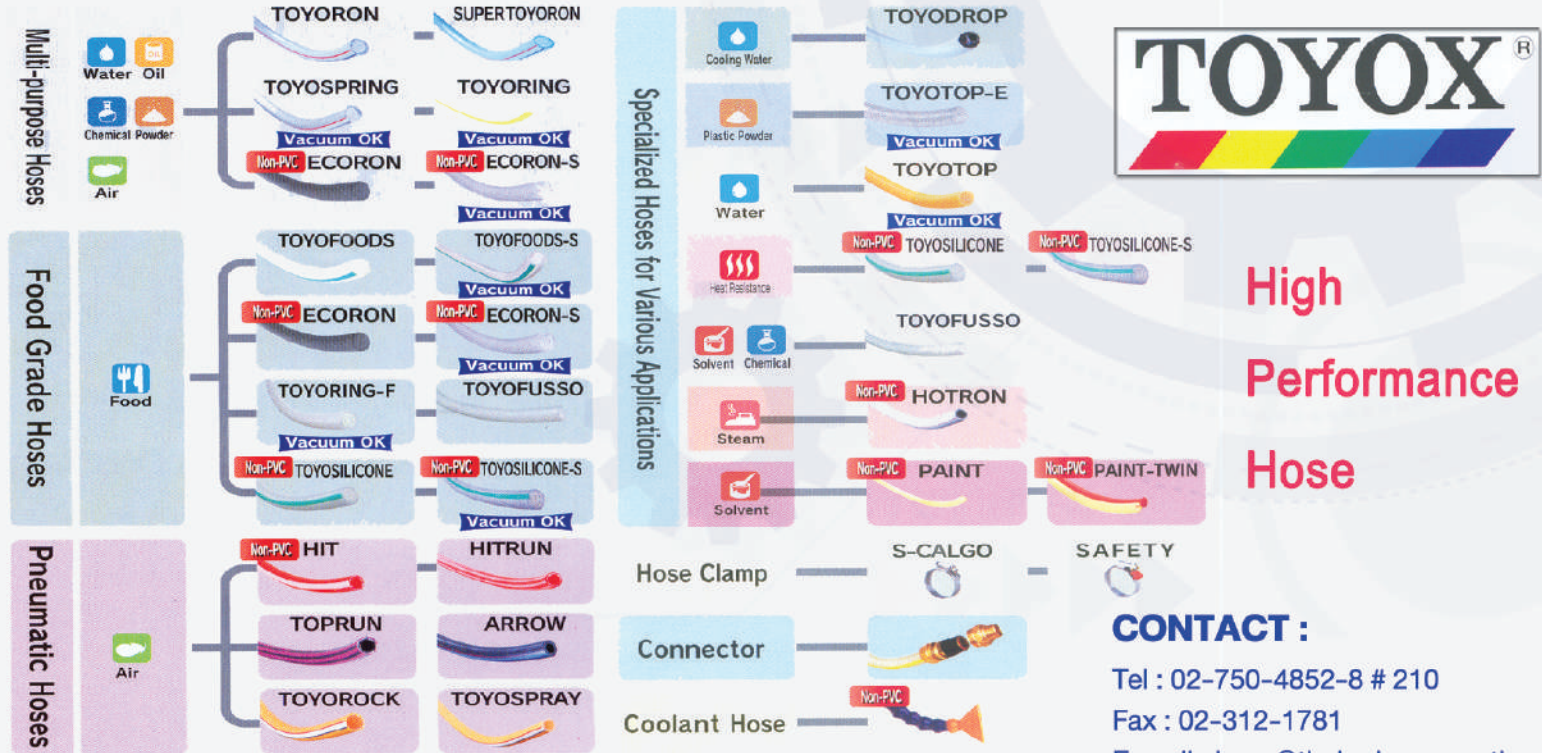

CONTACT :

Tel : 02-750-4852-8 # 210

Fax : 02-312-1781

E-mail : hose@thaipolymer.co.th



**PLASTICS PIPE FITTING
AND VALVE**

TEL : 02-750-4852-8 #134, 138

FAX : 02-312-2582

Email : ppfv@thaipolymer.co.th

Plastics pipe Fitting and valve

Material :

UPVC, Clean PVC, C-PVC, PP, PVDF, PE, ABS

Standard :

ANSI, SCH 80, DIN, JIS



SEALPACK
GRAPHITE MATERIAL

- Gland Packing
- Graphite Sheets
- Graphite Cutting
- Graphite Tapes
- Graphite Tube
- PTFE Joint Sealant Tapes

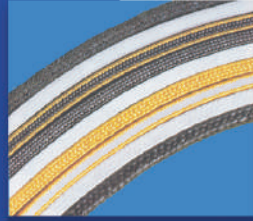

Gland Packing



Graphite Tube



Graphite Tapes

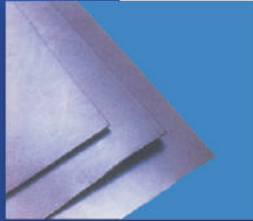

Graphite Sheets

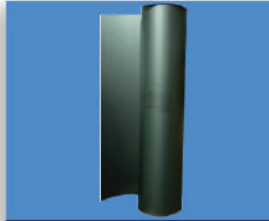

Graphite Foil Rolling

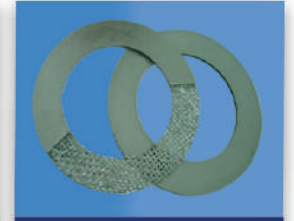

Graphite Cutting



SEALFLON

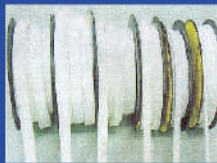

EXPANDED, VIRGIN PTFE JOINT SEALANT WITH ADHESIVE STRIP

TEL : 02-750-4852-8 #146-148 FAX : 02-312-2494

Mobile : 063-226-5159

Email : gasket@thaipolymer.co.th

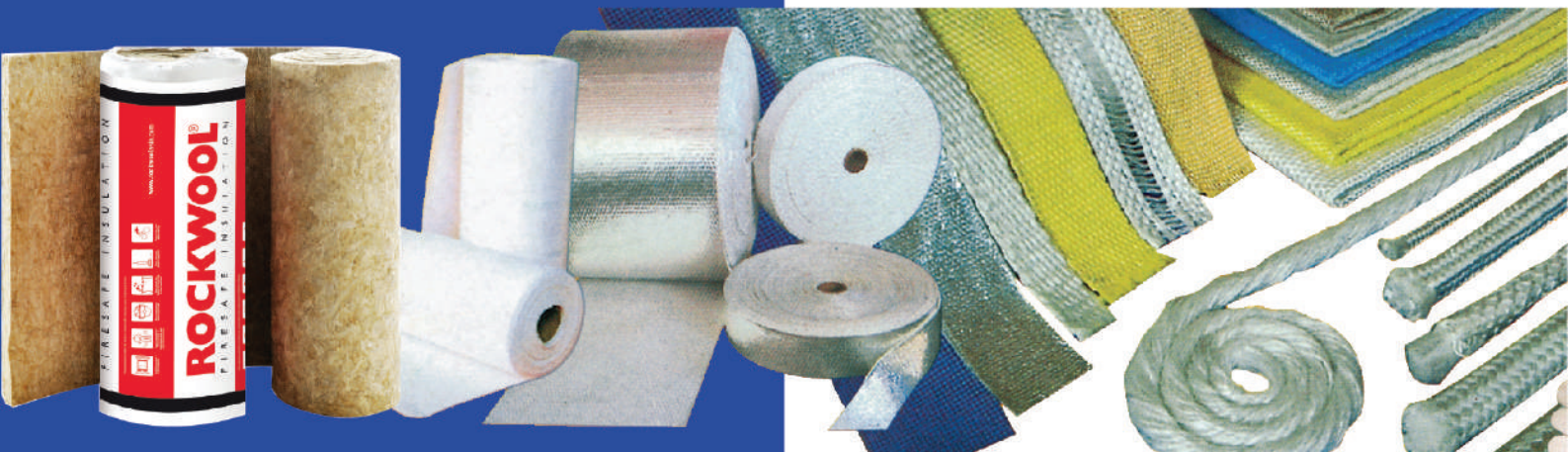

- Glass Fiber Cloth-Tape-Rope-Tadpole
- Ceramic Fiber Cloth-Tape-Rope-Blanket-Board-Paper
- Silica Fabric-Fire Blanket-Insulation Jacket-Expansion Joint-Made to order
- Rockwool-Microfiber-PU Foam-Other

Tel : 02-750-4852-8, 02-312-2021-5 #144

Fax : 02-312-2494

Email : Insulating@thaipolymer.co.th

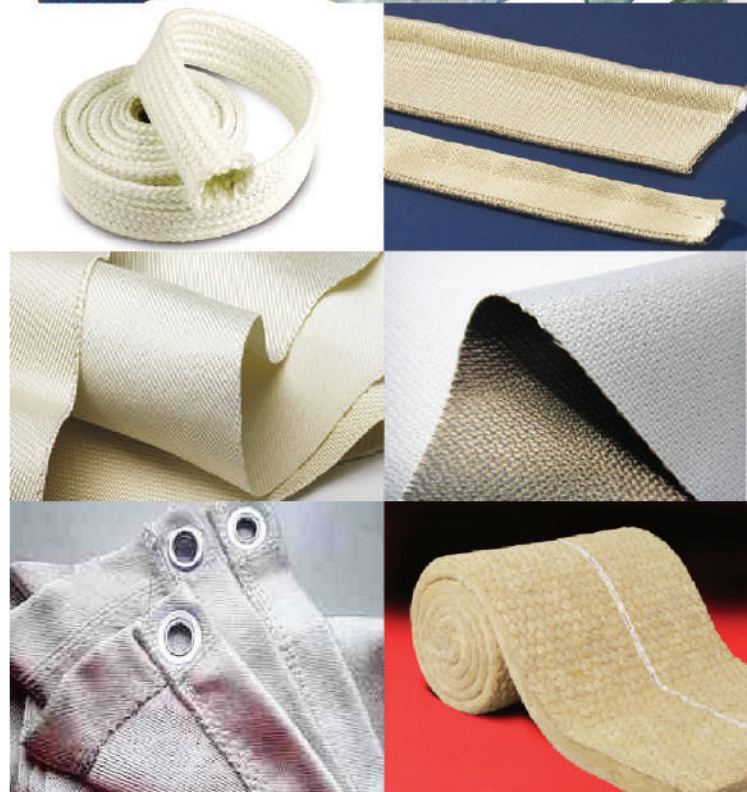

Product Range



EXPERIENCE THE EXCEPTIONAL



บริษัท สยามแมททีเรียล แอนด์ เอ็นจิเนียริ่ง จำกัด
SIAM MATERIALS & ENGINEERING CO.,LTD.

TEL : 02-750-4852-8 #184-188

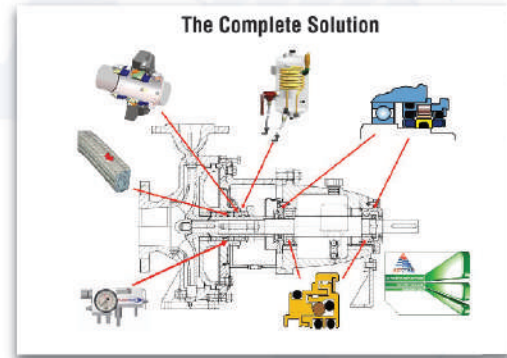

Food & Beverage



Pulp & Paper



Chemical



Automotive



Oil & Gas



Power Generation



Metal Processing



Water & Waste Water



HIGH PERFORMANCE

Rubber & Elastomers Sealing

PRODUCTS : O-RING, O-RING CORD, RUBBER SHEET, GASKET, HYDRAULIC & PNEUMATIC SEAL, MADE TO ORDER

TEL : 02-750-4852-8, 02-312-2021-5 #201-204
Email : oring@thaipolymer.co.th

MATERIAL : VITON, SILICONE, EPDM, NEOPRENE, NBR, NR

Roller



Rubber Sheet

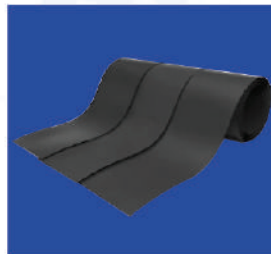

Gasket

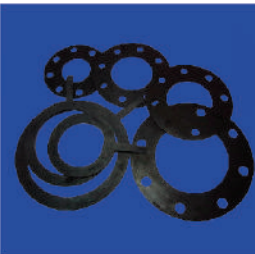

Made to Order



Made to Order



O-ring

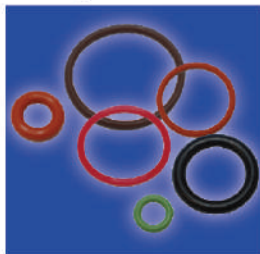

O-ring Cord

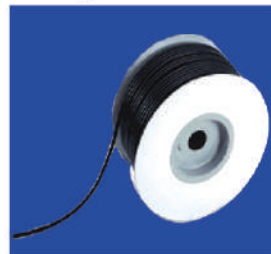

O-ring KIT



Oil & Hydraulic seal



Oil & Hydraulic seal



FLUID SYSTEM

James Walker® Moorflex

- Spiral wound gaskets
- Kammprofile gaskets
- Metal ring Joint gaskets
- Metal Jacket gaskets
- Flange Insulation Set gaskets
- Rubber Coated Ring Joint gaskets.
- Rota Bolt



Tel : 02-750-4852-8, 02-312-2021-5 #139-140

Email : jwm@thaipolymer.co.th



TEADIT®

Sealing for safer and greener tomorrow
NON-ASBESTOS

- Gland Packing For Pump, Valve Special Equipment
- Gasket Sheets
- Gasket Sheets Cutting For Standard Flange and Drawing
- Expanded and structured PTFE Sealing Materials



TEL : 02-750-4852-8 #146-148 FAX : 02-312-2494

Mobile : 063-226-5159

Email : gasket@thaipolymer.co.th

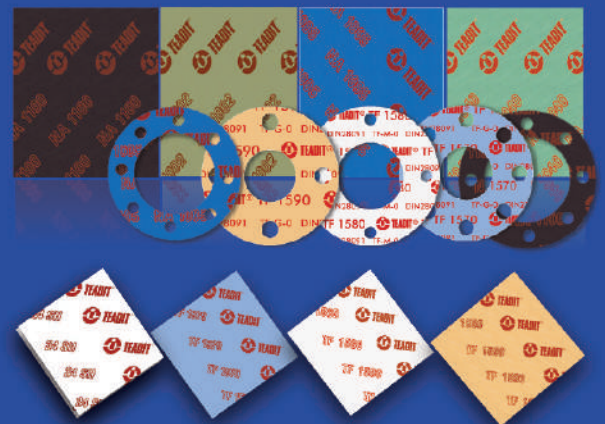
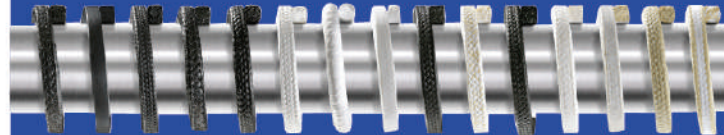

GL OPERATING





FLOORING SYSTEM



พื้นโรงงาน EPOXY

- ทำความสะอาดง่าย
- ทดกรดและด่าง
- รองรับน้ำหนักและแรงกระแทกได้ดี

PU CONCRETE

- ทำความสะอาดง่าย
- ทดกรดและด่าง
- ใช้งานได้กับพื้นที่มีกระบวนการทำงานที่มีน้ำมาเกี่ยวข้อง
- ทนต่ออุณหภูมิต่ำและสูง

พื้นสนามกีฬา และลานอเนกประสงค์ POLY URETHANE

- มีความยืดหยุ่นสูง
- ดูดซับแรงกระแทกจากกิจกรรมต่างๆ ได้ดี

EPOXY



PU CONCRETE



POLY URETHANE

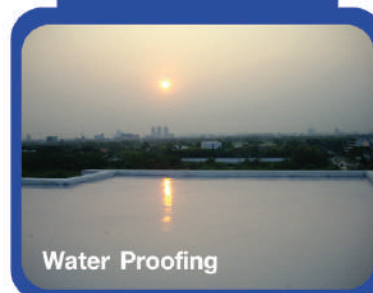

SPORT SURFACE



THAKOTECH CO.,LTD.
บริษัท ทาโคเทค จำกัด
www.thakotech.co.th

33/42 Moo 10 Theparak Rd. Bangpla Bangplee Samutprakarn 10540
Tel : 02-315-4231-6 Mobile : 086-369-4516 Fax.02-315-4238-9
Email : epoxy@thakotech.co.th, thakotech@thalpolymer.co.th



BRANCH

Rayong Branch	267/196 Muangmai Maphaphut, Muang, Rayong 21150 Tel. 038-608-925-7, 086-331-1692 Fax. 038-608-928 E-mail : branchry@thaipolymer.co.th
Laem Chabang Branch	299/8 Moo 1, Perfect Town Village, Naung Kham, Sri Racha, Chon Buri 20280 Tel. 038 196 045-7, 086-610-5432 Fax. 038-196-046 Email. branchlc@thaipolymer.co.th
Prachuap Khiri Khan Branch	183 Moo 2, Hnong Hu Chang Rd., Koak Lek, Muang, Prachuap Khiri Khan 77000 Tel. 032-611-529 Fax. 032-602-382 E-mail : branchpj@thaipolymer.co.th
Hatyai Branch	6 Moo 1 Sri-Siam Village, Leabmung-Asia Rd., Hatyai Songkhla 90110 Tel. : 074-556-441-2 Fax. : 074-556-443 E-mail : branchhy@thaipolymer.co.th
Surat Thanee Branch	150/2 Moo 4 Tha Rong Chang, Phun Phin, Surat Thani 84130 Tel. 077-960-653 Fax. 077-960-653 E-mail : branchsr@thaipolymer.co.th
Khon Kaen Branch	888/163 Moo 5 P.S. Home Village, Mung Khon kaen, Khonkaen 40000 Tel. 043-470-026, 081-302-1847, 095-198-9654 Fax. 043-470-126 E-mail : branchkk@thaipolymer.co.th
Nakhon Ratchasima Branch	233/54 Moo 1, Chaloe Phrakiat Rd., Nongkrathum, Muang, Nakhonratchasima 30000 Tel. 044-992-915 Fax. 044-992-914 E-mail : branchkr@thaipolymer.co.th
Saraburi Branch	792/26 Phichaironarongsongkhram Rd., Pakpreaw, Muang, Saraburi 18000 Tel. 036-731-599 Fax. 036-731-518 E-mail : branchsb@thaipolymer.co.th
Nakronpathom Branch	2/18 Sanam-Chan, Muang Nakronprathom 73000 Tel. 034-244-489 Fax. 034-244-490 E-mail : branchnt@thaipolymer.co.th
Chiang Mai Branch	161 Moo 1, Soi Wat Changkien, Huaykeaw Rd., Changpheuk, Muang, Chiangmai 50300 Tel. 053-221-621 Fax. 053-222-153 E-mail : branchcm@thaipolymer.co.th
Navanakorn Branch	26/56 Moo 18, Soi Navatai, Klongnueng, Klongluang, Pathumthani Tel. 02-529-5731-3 Fax. 02-529-5875 E-mail : branchnn@thaipolymer.co.th
Prachinburi Branch	339/11 Moo 10 Thatoom, Srimahaphote, Prachinburi 25140 Tel. 037-466-092 Fax. 037-466-093 E-mail : branchpc@thaipolymer.co.th
Samut Sakhon Branch	99/587 Moo 1, Amorn Chai Village 5., Soi 3A, Bang Nam Chuet, Muang, SamutSakhon 74000 Tel. (034)440-704-5, 063-224-3443 Fax. (034) 440-706 E-mail : branchmc@thaipolymer.co.th



Thai Polymer Supply Co., Ltd.

Engineering Plastics and Industrial products.



Polyurethane Co., Ltd.

Producing Polyurethane product.



Thakotech Co., Ltd.

Who is joint venture with Korea's company doing business of indoor and outdoor stadium from artificial turf, epoxy matel, or polyurethane material.



TPS Material Co., Ltd.

producing and providing ceramic products such as latex cup, bowl, plate, ect. The factory is located in Nakhonpanom province.

📍 406 Sukumvit 55 (Soi Thong Lor). Sukumvit Rd., Klongton Nue, Wattana, Bangkok 10110

☎ 0-2750-7296-7, 0-2750-4852-8 📞 0-2750-7299, 0-2312-1781

✉ marketing@thaipolymer.co.th 🌐 www.thaipolymer.co.th



website



scan for call