



# ELECTRICAL FITTING



**ISO 9001**  

---

**Certified**



## E.M.T. CONNECTORS

อี.เอ็ม.ที. คอนเน็คเตอร์

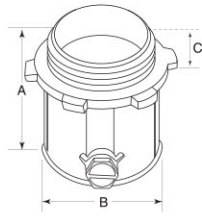

MATERIALS : ZINC ALLOY

Code No.	Size	A (mm.)	B (mm.)	C (mm.)
UI-F/ECT-33-050	1/2"	27.95	22.31	10.15
UI-F/ECT-33-075	3/4"	33.73	27.82	10.15
UI-F/ECT-33-100	1"	39.64	35.77	12.32
UI-F/ECT-33-125	1 1/4"	49.44	45.54	15.18
UI-F/ECT-33-150	1 1/2"	54.12	50.85	16.43
UI-F/ECT-33-200	2"	59.80	62.99	16.43

## E.M.T. COUPLINGS

อี.เอ็ม.ที. คูปลิง

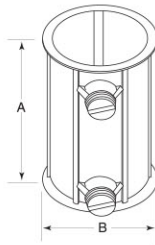

MATERIALS : ZINC ALLOY

Code No.	Size	A (mm.)	B (mm.)
UI-F/ECP-33-050	1/2"	36.36	22.84
UI-F/ECP-33-075	3/4"	44.46	29.36
UI-F/ECP-33-100	1"	51.42	34.68
UI-F/ECP-33-125	1 1/4"	63.07	45.44
UI-F/ECP-33-150	1 1/2"	71.86	51.28
UI-F/ECP-33-200	2"	85.16	62.55

## E.M.T. CONNECTORS COMPRESSION TYPE

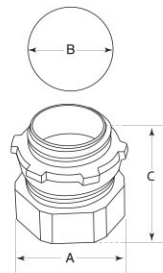

MATERIALS : ZINC ALLOY

Code No.	Size	A (mm.)	B (mm.)	C (mm.)
UI-F/RCT-34-050	1/2"	22.17	8.69	25.02
UI-F/RCT-34-075	3/4"	23.09	9.03	30.61
UI-F/RCT-34-100	1"	23.79	12.78	37.57
UI-F/RCT-34-125	1 1/4"	29.78	14.32	45.95
UI-F/RCT-34-150	1 1/2"	31.95	15.31	63.27
UI-F/RCT-34-200	2"	34.13	19.23	65.23

## E.M.T. COUPLINGS COMPRESSION TYPE

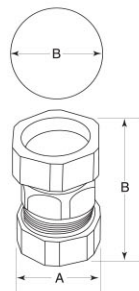

MATERIALS : ZINC ALLOY

Code No.	Size	A (mm.)	B (mm.)
UI-F/RCP-33-050	1/2"	37.88	25.02
UI-F/RCP-33-075	3/4"	40.65	30.61
UI-F/RCP-33-100	1"	49.01	37.57
UI-F/RCP-33-125	1 1/4"	55.57	45.95
UI-F/RCP-33-150	1 1/2"	60.93	53.27
UI-F/RCP-33-200	2"	64.33	65.23

Code No.	Size	A (mm.)	B (mm.)	C (mm.)
RFC33-050	1/2"	33.02	11.85	33.22
RFC33-075	3/4"	38.1	13.71	39.97
RFC33-100	1"	43.25	16.13	45.26
RFC33-125	1 1/4"	45.26	16.6	54.87
RFC33-150	1 1/2"	43.87	15.75	63.5
RFC33-200	2"	51.6	17.76	76.41
RFC33-250	2 1/2"	79.51	27.69	102.5
RFC33-300	3"	79.32	24.81	121.65
RFC33-400	4"	101.78	35.76	152.61

**RAIN TIGHT FLEXIBLE CONNECTOR**

คอนเน็คเตอร์ท่ออ่อนกันน้ำ

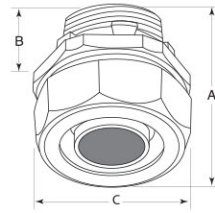

**MATERIALS :** ♦ ZINC ALLOY  
 SIZE RANGES : 1/2" TO 2"  
 ♦ CAST IRON  
 SIZE RANGES : 2 1/2" TO 4"

Code No.	Size
UI-F/NMC 33-050	1/2"
UI-F/NMC 33-075	3/4"
UI-F/NMC 33-100	1"

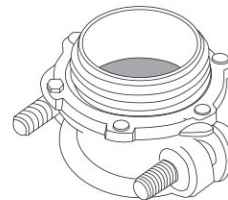

**N.M. CONNECTOR**

เอ็น เอ็ม คอนเน็คเตอร์

**MATERIALS :** ZINC ALLOY

Code No.	Size	ขนาด	I.D.-วงใน (mm.)		O.D.-วงนอก (mm.)		ความหนา (mm.)		น้ำหนัก (K.g.)		รัศมีความโค้ง (mm.)	ความยาว	
			Max	Min	Max	Min	Max	Min	ต่อเมตร	ต่อฟุต		(F.L)	(M.)
RTF33 - 050	1/2"	16	16.3	15.7	21.3	20.8	1.30	1.00	0.37	0.112	100	200	60
RTF33 - 075	3/4"	20	21.3	20.7	26.7	26.2	1.55	1.25	0.52	0.140	120	100	30
RTF33 - 100	1"	25	26.8	26.0	33.4	32.7	1.80	1.50	0.78	0.226	150	100	30
RTF33 - 125	1 1/4"	35	35.4	34.6	42.2	41.5	1.55	1.25	1.20	0.290	200	50	15
RTF33 - 150	1 1/2"	40	40.6	39.6	48.3	47.3	2.15	1.75	1.50	0.358	250	50	15
RTF33 - 200	2"	50	51.8	51.8	60.3	59.4	2.65	2.15	1.90	0.488	450	50	15
RTF33 - 250	2 1/2"	60	63.7	62.5	73.0	72.1	2.50	1.80	2.10	0.704	600	25	7.5
RTF33 - 300	3"	75	78.8	77.6	88.9	87.8	2.90	2.20	3.40	0.952	900	25	7.5
RTF33 - 400	4"	100	102.5	101.1	114.3	113.2	3.05	2.35	5.60	1.324	1200	25	7.5

**RAIN TIGHT FLEXIBLE CONDUIT**

ท่ออ่อนกันน้ำ



**FLEXIBLE CONNECTOR**

คอนเน็คเตอร์

Code No.	Size	Code No.	Size
UI-F / FC 33-050	1/2"	UI-F / FC 33-200	2"
UI-F / FC 33-075	3/4"	UI-F / FC 33-250	2 1/2"
UI-F / FC 33-100	1"	UI-F / FC 33-300	3"
UI-F / FC 33-125	1 1/4"	UI-F / FC 33-400	4"
UI-F / FC 33-150	1 1/2"		

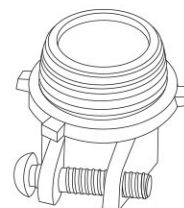

**MATERIALS :** ♦ ZINC ALLOY  
 SIZE RANGES 1/2" TO 1"  
 ♦ CAST IRON  
 SIZE RANGES 1/4" TO 4"

## FLEXIBLE STEEL CONDUIT

ท่ออ่อนเหล็ก

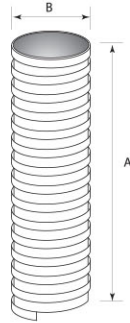

Code No.	Size	I.D.-วงใน (mm.)	O.D.-วงนอก (mm.)	ความยาว/ชุด (M.)
UI-F/FSC 33-050	1/2"	12.40	15.30	50
UI-F/FSC 33-075	3/4"	19.00	22.00	50
UI-F/FSC 33-100	1"	25.00	28.30	30
UI-F/FSC 33-125	1 1/4"	32.50	37.00	15
UI-F/FSC 33-150	1 1/2"	38.00	42.50	15
UI-F/FSC 33-200	2"	50.00	55.80	15
UI-F/FSC 33-250	2 1/2"	63.00	70.00	10
UI-F/FSC 33-300	3"	76.00	83.00	10
UI-F/FSC 33-400	4"	102.00	109.00	10

## LOCKNUT

ล็อกนัท

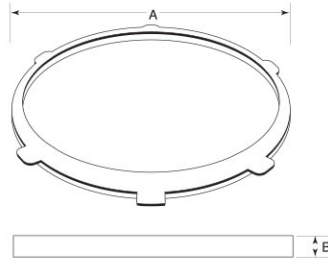
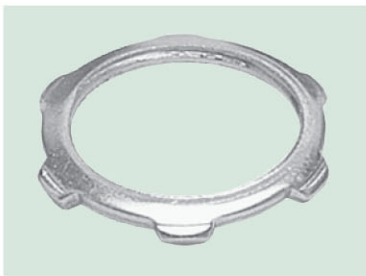

**MATERIALS** : STEEL SHEET (1/2" - 4" SIZE)

CAST IRON (5" - 6" SIZE)

**FINISHING** : ELECTRO GALVANIZED

Code No.	Size	A (mm.)	B (mm.)
UI-F/ILN-33-050	1/2"	29.5	2.09
UI-F/ILN-33-075	3/4"	35.87	2.32
UI-F/ILN-33-100	1"	44.9	2.32
UI-F/ILN-33-125	1 1/4"	52.78	2.9
UI-F/ILN-33-150	1 1/2"	62.03	3.5
UI-F/ILN-33-200	2"	73.49	23.24

Code No.	Size	A (mm.)	B (mm.)
UI-F/ILN-33-250	2 1/2"	88.15	3.55
UI-F/ILN-33-300	3"	106.54	4.01
UI-F/ILN-33-350	3 1/2"	120.16	3.81
UI-F/ILN-33-400	4"	133.9	3.88
UI-F/ILN-33-500	5"	158.26	18.4
UI-F/ILN-33-600	6"	188.12	18.45

## BUSHING

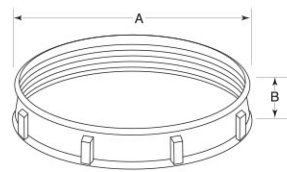

**MATERIALS** : ZINC ALLOY

Code No.	Size	A (mm.)	B (mm.)
UI-F/BIC33-050	1/2"	26.8	8.54
UI-F/BIC33-075	3/4"	31.49	9.49
UI-F/BIC33-100	1"	37.54	11.21
UI-F/BIC33-125	1 1/4"	47.89	12.72
UI-F/BIC33-150	1 1/2"	53.98	12
UI-F/BIC33-200	2"	64.69	12.68

Code No.	Size	A (mm.)	B (mm.)
UI-F/BIC33-250	2 1/2"	79.58	15.22
UI-F/BIC33-300	3"	94.48	17.46
UI-F/BIC33-350	3 1/2"	112.15	21.27
UI-F/BIC33-400	4"	121.58	20.6
UI-F/BIC33-500	5"	157	24

Code No.	Size	A (mm.)	B (mm.)
UI-F/SE-33-050	1/2"	53.43	15.00
UI-F/SE-33-075	3/4"	64.09	15.00
UI-F/SE-33-100	1"	73.50	15.00
UI-F/SE-33-125	1 1/4"	80.62	20.00
UI-F/SE-33-150	1 1/2"	95.15	20.00
UI-F/SE-33-200	2"	107.10	20.00

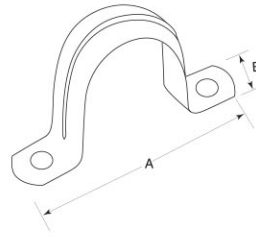

**MATERIALS** : STEEL SHEET  
**FINISHING** : ELECTRO GALVANIZED

**E.M.T. STRAP-2 HOLE**

แคลมป์จับท่อบาง



Code No.	Size	A (mm.)	B (mm.)
UI-F/SE-34-050	1/2"	39.20	15.00
UI-F/SE-34-075	3/4"	46.20	15.00
UI-F/SE-34-100	1"	49.33	15.00
UI-F/SE-34-125	1 1/4"	60.62	20.00
UI-F/SE-34-150	1 1/2"	74.49	20.00
UI-F/SE-34-200	2"	87.38	20.00

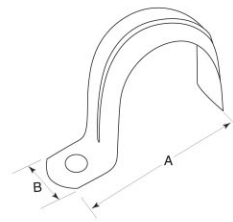

**MATERIALS** : STEEL SHEET  
**FINISHING** : ELECTRO GALVANIZED

**E.M.T. STRAP-1 HOLE**

แคลมป์จับท่อบาง



Code No.	Size	A (mm.)	B (mm.)
UI-F/PCE-33-050	1/2"	42.8	17.93
UI-F/PCE-33-075	3/4"	50.44	23.42
UI-F/PCE-33-100	1"	56.05	29.54
UI-F/PCE-33-125	1 1/4"	66.48	38.35
UI-F/PCE-33-150	1 1/2"	71.14	44.20
UI-F/PCE-33-200	2"	87.63	55.80

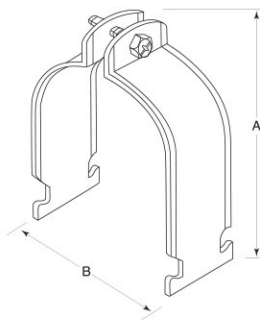

**MATERIALS** : STEEL SHEET  
**FINISHING** : ELECTRO GALVANIZED

**E.M.T. PIPE CLAMPS**

แคลมป์ประกับอีเอ็มที



Code No.	A (mm.)	B (mm.)	C (mm.)
UI-F/CN-33-025	25	40	1200
UI-F/CN-33-040	40	40	1200

**MATERIALS** : GALVANIZED STEEL SHEET  
**SIZE** : 1.20 M.  
**THICKNESS** : 1.6 mm., 2.0 mm. (C + - 0.10 mm.)

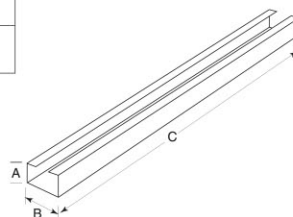
**C-CHANNELS**

รางตัวซี

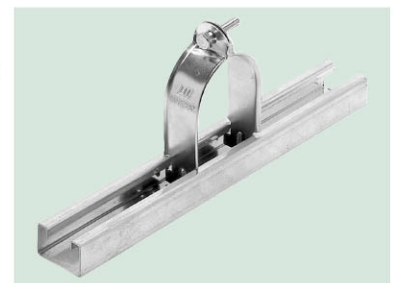

## I.M.C. PIPE CLAMPS

แคลมป์ประกับไอเอ็มซี

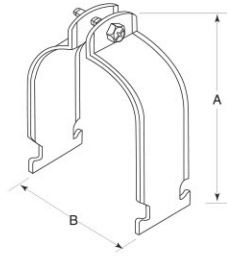

**MATERIALS** : STEEL SHEET  
**FINISHING** : ELECTRO GALVANIZED

Code No.	Size	A (mm.)	B (mm.)
UI-F/PCI-33-050	1/2"	45.89	20.8
UI-F/PCI-33-075	3/4"	52.31	26.3
UI-F/PCI-33-100	1"	60.91	32.7
UI-F/PCI-33-125	1 1/4"	68.86	41.9
UI-F/PCI-33-150	1 1/2"	74.23	48.0
UI-F/PCI-33-200	2"	88.07	60.1
UI-F/PCI-33-250	2 1/2"	107.38	72.8
UI-F/PCI-33-300	3"	122.51	88.5
UI-F/PCI-33-350	3 1/2"	148.26	101.1
UI-F/PCI-33-400	4"	153.19	113.7

## SUPPORT CLAMPS

แผ่นจระเข้

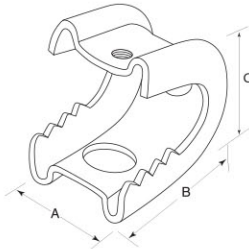

**MATERIALS** : STEEL SHEET  
**FINISHING** : ELECTRO GALVANIZED  
HOT DIP GALVANIZED  
POWDER COATING

Code No.	A (mm.)	B (mm.)	C (mm.)
UI-F/UN-33-025	34.84	43	47.51

## CONDUIT SUPPORT CLIPS

แคลมป์บ่วงเตี๊ยน

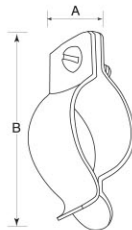

**MATERIALS** : STEEL SHEET  
**FINISHING** : ELECTRO GALVANIZED  
HOT DIP GALVANIZED

Code No.	Size	Code No.	Size
C33 - 050	1/2"	C33 - 125	1 1/4"
C33 - 075	3/4"	C33 - 150	1 1/2"
C33 - 100	1"	C33 - 200	2"

## I.M.C. STRAP-2-HOLE

แคลมป์จับท่อหนา

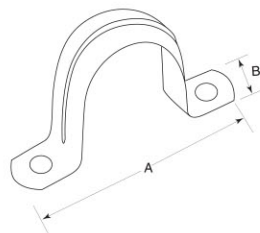

**MATERIALS** : STEEL SHEET  
**FINISHING** : ELECTRO GALVANIZED

Code No.	Size	A (mm.)	B (mm.)
UI-F/SI-33-050-2	1/2"	67.70	15.00
UI-F/SI-33-075-2	3/4"	64.60	15.00
UI-F/SI-33-100-2	1"	73.50	15.00
UI-F/SI-33-125-2	1 1/4"	82.60	20.00
UI-F/SI-33-150-2	1 1/2"	87.73	20.00
UI-F/SI-33-200-2	2"	118.40	20.00
UI-F/SI-33-250-2	2 1/2"	134.20	25.00
UI-F/SI-33-300-2	3"	165.50	25.00
UI-F/SI-33-400-2	4"	192.80	25.00

**HANDY BOXES**

Code No.	Size	Type	A (mm.)	B (mm.)	C (mm.)
UI-F/HANDY BOX HB33-1001	2" x 4" x 1 1/2"	1/2"	98.84	52.88	37.65
	2" x 4" x 1 1/2"	1/2" x 3/4" x 1 1/2"	98.84	52.88	37.65
	2" x 4" x 1 1/2"	หน้า-ๆ	98.84	52.88	37.65
UI-F/HANDY BOX HB33-1002	2" x 4" x 2"	1/2"	98.84	52.88	48.82
	2" x 4" x 2"	3/4"	98.84	52.88	48.82
	2" x 4" x 2"	1/2" x 3/4"	98.84	52.88	48.82
	2" x 4" x 2"	1/2" x 3/4" x 1 1/2"	98.84	52.88	48.82
	2" x 4" x 2"	หน้า-ๆ	98.84	52.88	48.82

**MATERIALS** : STEEL SHEET 1.0 mm.  
**FINISHING** : ELECTRO GALVANIZED

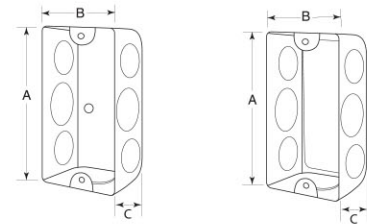
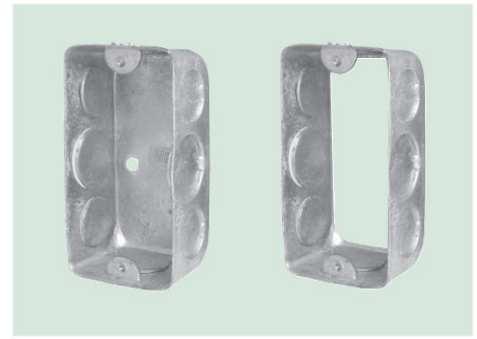

**SQUARE BOXES**

Code No.	Size	Type	A (mm.)	B (mm.)	C (mm.)
UI-F/SQUARE BOX	4" x 4" x 1 1/2"	1/2" x 3/4" x 1 1/2"	99.98	99.98	36.65
S33-2001 (หน้า)	4" x 4" x 1 1/2"	หน้า(หน้า)	99.98	99.98	36.65
UI-F/SQUARE BOX	4" x 4" x 2"	1/2" x 3/4" x 1 1/2"	99.98	99.98	50.34
S33-2002 (หน้า)	4" x 4" x 2"	1" x 3/4"	99.98	99.98	50.34
	4" x 4" x 2"	3/4" (หน้า) 1" (หน้า)	99.98	99.98	50.34
	4" x 4" x 2"	หน้า-ๆ	99.98	99.98	50.34

**MATERIALS** : STEEL SHEET 1.0 mm.  
**FINISHING** : ELECTRO GALVANIZED

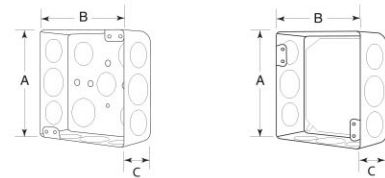

**OCTAGON BOXES**

Code No.	Size	Type	A (mm.)	B (mm.)	C (mm.)
UI-F/033-3001 (หน้า)	3" x 5/8" x 1 1/2"	1/2" x 3/4"	92.81	92.81	37.68
	3" x 5/8" x 2"	1/2" x 3/4"(หน้า)	92.81	92.81	37.68
UI-F/033-3002 (หน้า)	3" x 5/8" x 2"	1/2" x 3/4"	92.81	92.81	50.34

**MATERIALS** : STEEL SHEET 1.0 mm.  
**FINISHING** : ELECTRO GALVANIZED

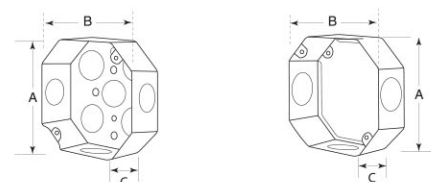



EUROPA BOXES

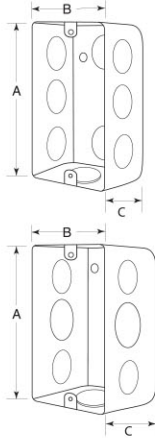

Code No.	Size	A (mm.)	B (mm.)	C (mm.)
UI-F/EB33-4001	1/2" x 3/4" x 1/2"	99.52	62.93	38.16
UI-F/EB33-4002	1/2" x 3/4" x 1/2" (n:a)	99.52	62.93	50.86

**MATERIALS :** STEEL SHEET 1.0 mm.  
**FINISHING :** ELECTRO GALVANIZED

M.K. BOXES

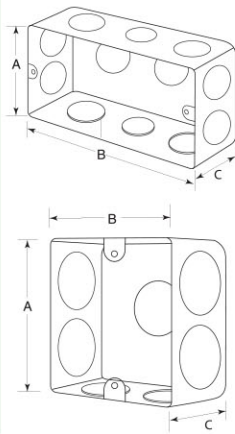

Code No.	Size	A (mm.)	B (mm.)	C (mm.)
UI-F/MK33-3001	1/2" x 3/4"	73.27	73.27	46.91
UI-F/MK33-3002	1/2" x 3/4"	73.27	73.27	55.26
UI-F/MK42-3001	3/4" - 1/2" - 3/4"	132.27	73.27	36.60
UI-F/MK42-3002	3/4" - 1/2" - 3/4"	132.27	73.27	48.57

**MATERIALS :** STEEL SHEET 1.0 mm.  
**FINISHING :** ELECTRO GALVANIZED

COVER RAISED FOR SQUARE BOX 4" X 4"

ฝาปิดสแควร์บ็อกซ์ และฝาเสริมสแควร์บ็อกซ์ 4" x 4"

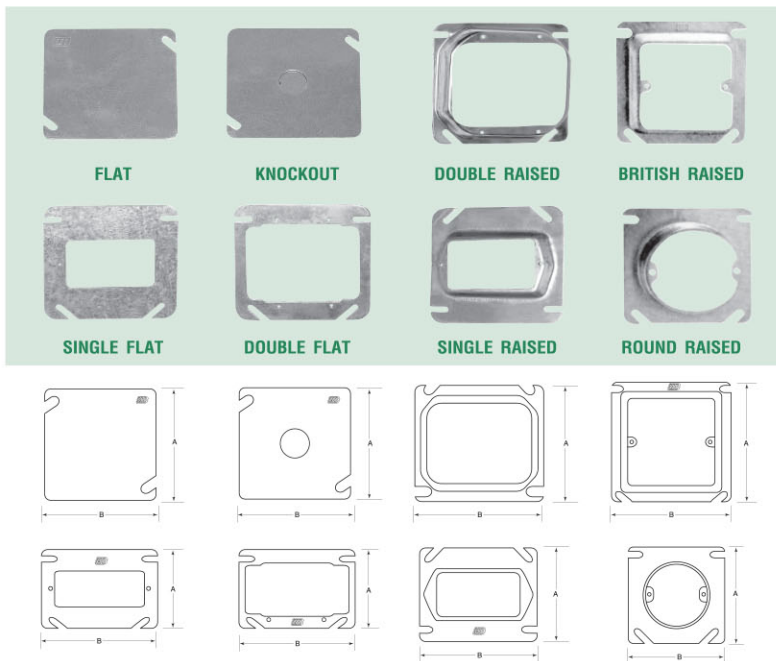

Type	
LID	FLAT
	KNOCKOUT
FLAT	SINGLE
	DOUBLE
STAND OUT	SINGLE
	DOUBLE
	ROUND RAISED
	BRITISH RAISED

**MATERIALS :** STEEL SHEET  
**FINISHING :** ELECTRO GALVANIZED  
: HOT DIP GALVANIZED

COVER FOR OCTAGON BOXES

ฝาปิดอีกตาก้อนบ็อกซ์

**MATERIALS** : STEEL SHEET  
**FINISHING** : ELECTRO GALVANIZED  
 : HOT DIP GALVANIZED



FLAT

KNOCKOUT

ROUND RAISED

COVER FOR FOR HANDY BOXES 2" x 4"

ฝาปิดแฮนด์บ็อกซ์ 2" x 4"

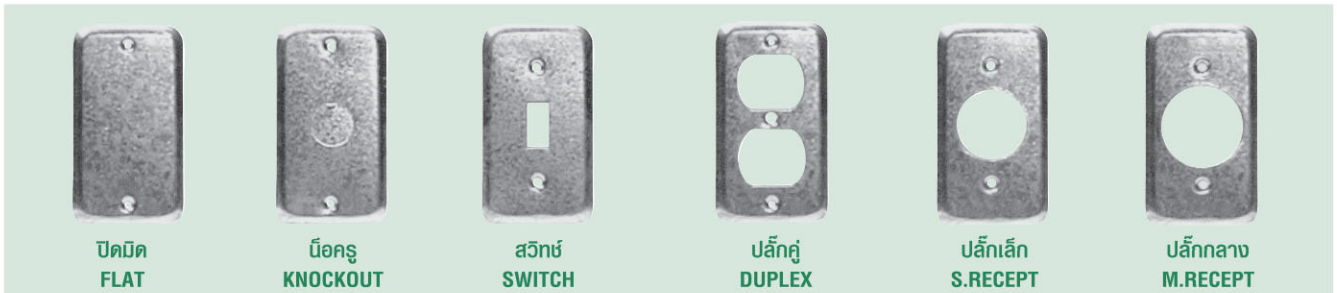

ปิดมิด  
FLAT

บ็อกซ์  
KNOCKOUT

สวิตช์  
SWITCH

ปลั๊กคู่  
DUPLEX

ปลั๊กเล็ก  
S.RECEPT

ปลั๊กกลาง  
M.RECEPT

**MATERIALS** : STEEL SHEET  
**FINISHING** : ELECTRO GALVANIZED, HOT DIP GALVANIZED

F.S. COVER OLATES SINGLE GANG

ฝาปิด เอฟ.เอส. บ็อกซ์ ซิงเกิ้ล แก๊งค์

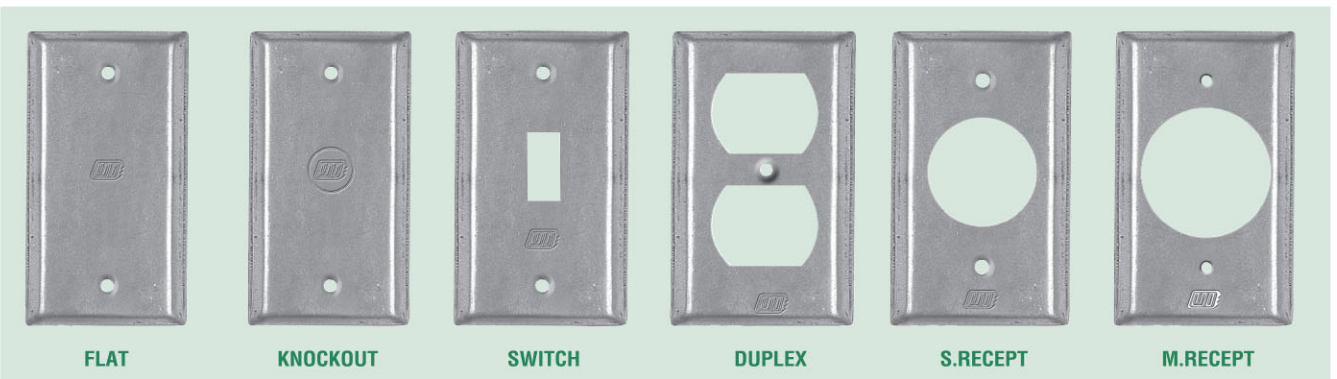

FLAT

KNOCKOUT

SWITCH

DUPLEX

S.RECEPT

M.RECEPT

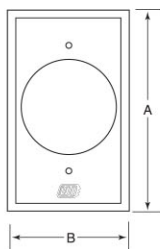
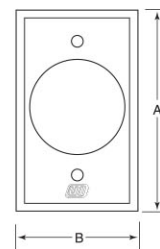
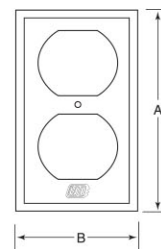
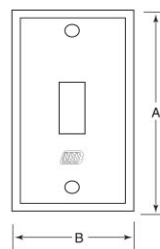
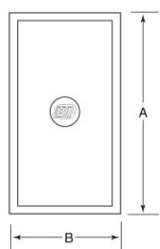
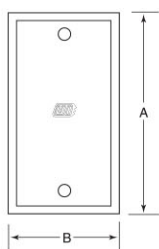

Code No.	A (mm.)	B (mm.)
FLAT	107.77	60.27
KNOCKOUT	107.77	60.27
DUPLEX	107.77	60.27

Code No.	A (mm.)	B (mm.)
M.RECEPT	107.77	60.27
S.RECEPT	107.77	60.27

**MATERIALS** : STEEL SHEET  
 STAINLESS  
 ALUMINIUM  
**FINISHING** : ELECTRO GALVANIZED

## I.M.C. COUPLING

ข้อต่อชนิดหนา

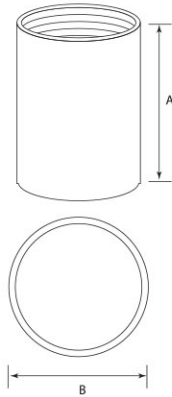

**MATERIALS** : HOT-ROLLED STEEL STRIP  
**FINISHING** : HOT DIP GALVANIZED  
 ELECTRO GALVANIZED

Code No.	Size	Price
UI-F/ICP-33-050	1/2"	12.00
UI-F/ICP-33-075	3/4"	14.00
UI-F/ICP-33-100	1"	17.50
UI-F/ICP-33-125	1 1/4"	28.00
UI-F/ICP-33-150	1 1/2"	35.00
UI-F/ICP-33-200	2"	53.00
UI-F/ICP-33-250	2 1/2"	105.00
UI-F/ICP-33-300	3"	130.00
UI-F/ICP-33-350	3 1/2"	200.00
UI-F/ICP-33-400	4"	220.00
UI-F/ICP-33-400	5"	360.00
UI-F/ICP-33-500	6"	550.00

## ERIKSON COUPLING

อีริกสัน กู๊ปปลิ่ง

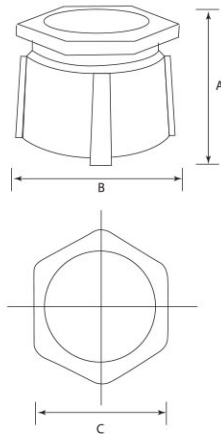

**MATERIALS** : CAST IRON  
**FINISHING** : HOT DIP GALVANIZED  
 ELECTRO GALVANIZED  
 POWDER COATING

Code No.	Size	Price
UI-F/ECP-33-050	1/2"	40.00
UI-F/ECP-33-075	3/4"	50.00
UI-F/ECP-33-100	1"	65.00
UI-F/ECP-33-125	1 1/4"	115.00
UI-F/ECP-33-150	1 1/2"	150.00
UI-F/ECP-33-200	2"	205.00
UI-F/ECP-33-250	2 1/2"	315.00
UI-F/ECP-33-300	3"	435.00
UI-F/ECP-33-350	3 1/2"	610.00
UI-F/ECP-33-400	4"	630.00
UI-F/ECP-33-500	5"	750.00

Code No.	Size	A (mm.)	B (mm.)	C (mm.)
UI-F/CLB-33-050	1/2"	105	38	25
UI-F/CLB-33-075	3/4"	124	45	33
UI-F/CLB-33-100	1"	143	52	40
UI-F/CLB-33-125	1 1/4"	155	57	49
UI-F/CLB-33-150	1 1/2"	185	68	55
UI-F/CLB-33-200	2"	233	78	70
UI-F/CLB-33-250	2 1/2"	255	83	92
UI-F/CLB-33-300	3"	290	105	101
UI-F/CLB-33-300	3 1/2"	350	138	119
UI-F/CLB-33-400	4"	350	138	119

## CONDUIT OUTLET (LB)

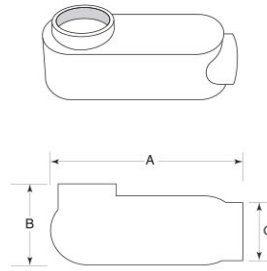

**MATERIALS:** ALUMINIUM ALLOY  
**FINISHING:** POWDER COATING

Code No.	Size	A (mm.)	B (mm.)	C (mm.)
UI-F/CLL-33-050	1/2"	105	38	25
UI-F/CLL-33-075	3/4"	124	45	33
UI-F/CLL-33-100	1"	143	52	40
UI-F/CLL-33-125	1 1/4"	155	57	49
UI-F/CLL-33-150	1 1/2"	185	68	55
UI-F/CLL-33-200	2"	233	78	70
UI-F/CLL-33-250	2 1/2"	255	83	92
UI-F/CLL-33-300	3"	290	105	101
UI-F/CLL-33-300	3 1/2"	350	138	119
UI-F/CLL-33-400	4"	350	138	119

## CONDUIT OUTLET (LL)

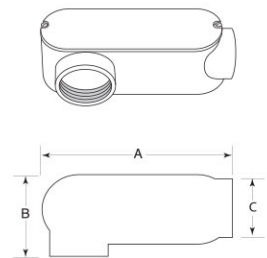

**MATERIALS:** ALUMINIUM ALLOY  
**FINISHING:** POWDER COATING

Code No.	Size	A (mm.)	B (mm.)	C (mm.)
UI-F/CLR-33-050	1/2"	105	38	25
UI-F/CLR-33-075	3/4"	124	45	33
UI-F/CLR-33-100	1"	143	52	40
UI-F/CLR-33-125	1 1/4"	155	57	49
UI-F/CLR-33-150	1 1/2"	185	68	55
UI-F/CLR-33-200	2"	233	78	70
UI-F/CLR-33-250	2 1/2"	255	83	92
UI-F/CLR-33-300	3"	290	105	101
UI-F/CLR-33-300	3 1/2"	350	138	119
UI-F/CLR-33-400	4"	350	138	119

## CONDUIT OUTLET (LR)

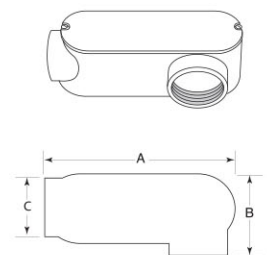

**MATERIALS:** ALUMINIUM ALLOY  
**FINISHING:** POWDER COATING

**CONDUIT OUTLET (OT)**

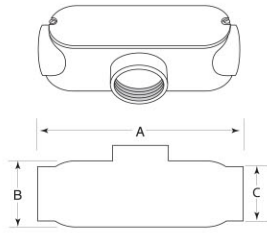
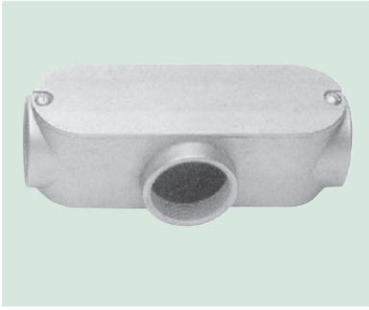

**MATERIALS:** ALUMINIUM ALLOY  
**FINISHING :** POWDER COATING

Code No.	Size	A (mm.)	B (mm.)	C (mm.)
UI-F/COT-33-050	1/2"	120	38	28
UI-F/COT-33-075	3/4"	139	48	33
UI-F/COT-33-100	1"	148	52	40
UI-F/COT-33-125	1 1/4"	165	59	48
UI-F/COT-33-150	1 1/2"	188	62	55
UI-F/COT-33-200	2"	237	78	70
UI-F/COT-33-250	2 1/2"	263	92	83

**ENTRANCE CAP**



**MATERIALS:** ALUMINIUM ALLOY COVER  
**FINISHING :** POWDER COATING

Code No.	Size	Code No.	Size
UI-F/SEC 33-050	1/2"	UI-F/SEC 33-250	2 1/2"
UI-F/SEC 33-075	3/4"	UI-F/SEC 33-300	3"
UI-F/SEC 33-100	1"	UI-F/SEC 33-400	4"
UI-F/SEC 33-125	1 1/4"	UI-F/SEC 33-400	5"
UI-F/SEC 33-150	1 1/2"	UI-F/SEC 33-400	6"
UI-F/SEC 33-200	2"		

**F.S. BOXES  
(1 WAY)**

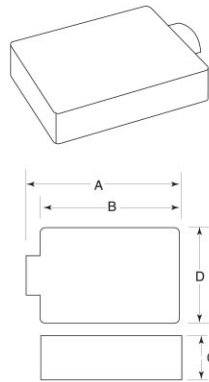

Code No.	Size	A (mm.)	B (mm.)	C (mm.)	D (mm.)
UI-F/FS-24-1050	1/2"	133	116	48	71
UI-F/FS-24-1075	3/4"	133	116	48	71

**MATERIALS:** ALUMINIUM ALLOY  
CAST IRON  
**FINISHING :** POWDER COATING  
HOT DIP GALVANIZED

**F.S.C. BOXES  
(2 WAY TWIN)**

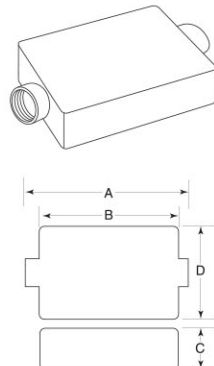

Code No.	Size	A (mm.)	B (mm.)	C (mm.)	D (mm.)
UI-F/FSC-24-2050	1/2"	133	116	48	71
UI-F/FSC-24-2075	3/4"	133	116	48	71

**MATERIALS:** ALUMINIUM ALLOY  
CAST IRON  
**FINISHING :** POWDER COATING  
HOT DIP GALVANIZED

**F.S.S.C.C. BOXES  
(3 WAY TWIN)**

Code No.	Size	A (mm.)	B (mm.)	C (mm.)	D (mm.)
UI-F/FSSCC-24-4050	1/2"	133	116	48	71
UI-F/FSSCC-24-4075	3/4"	133	116	48	71

**MATERIALS:** ALUMINIUM ALLOY  
CAST IRON  
**FINISHING :** POWDER COATING  
HOT DIP GALVANIZED

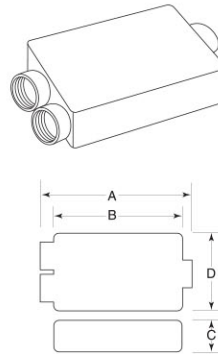

**F.S.S. BOXES  
(2 WAY TWIN)**

Code No.	Size	A (mm.)	B (mm.)	C (mm.)	D (mm.)
UI-F/FSS-24-3050	1/2"	133	116	48	71
UI-F/FSS-24-3075	3/4"	133	116	48	71

**MATERIALS:** ALUMINIUM ALLOY  
CAST IRON  
**FINISHING :** POWDER COATING  
HOT DIP GALVANIZED

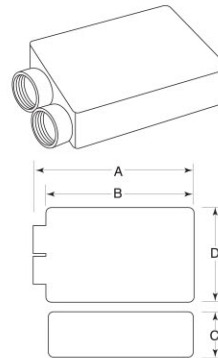

**F.S. BOXES  
(1 WAY)**

Code No.	Size	A (mm.)	B (mm.)	C (mm.)
UI-F/FS-24-1050	1/2"	133	116	48
UI-F/FS-24-1075	3/4"	133	116	48

**MATERIALS:** ALUMINIUM ALLOY  
CAST IRON  
**FINISHING :** POWDER COATING  
HOT DIP GALVANIZED

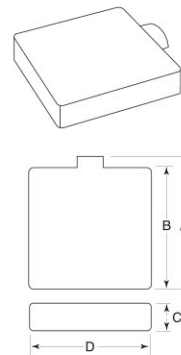

**F.S.C. BOXES  
(SQUARE 2 WAY TWIN)**

Code No.	Size	A (mm.)	B (mm.)	C (mm.)
UI-F/FSC-44-2050	1/2"	133	116	48
UI-F/FSC-44-2075	3/4"	133	116	48

**MATERIALS:** ALUMINIUM ALLOY  
CAST IRON  
**FINISHING :** POWDER COATING  
HOT DIP GALVANIZED

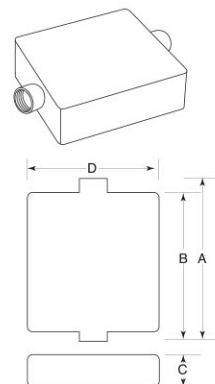

## F.S.S. BOXES (SQUARE 2 WAY TWIN)

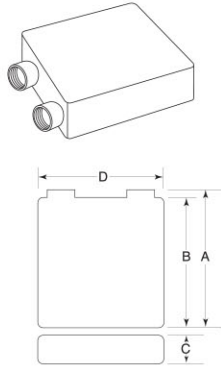

Code No.	Size	A (mm.)	B (mm.)	C (mm.)
UI-F/FSS-44-3050	1/2"	133	116	48
UI-F/FSS-44-3075	3/4"	133	116	48

**MATERIALS :** ALUMINIUM ALLOY  
CAST IRON  
**FINISHING :** POWDER COATING  
HOT DIP GALVANIZED

## F.S.S.C.C. BOXES (3 WAY TWIN)

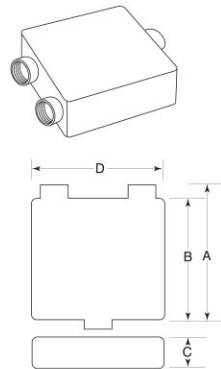

Code No.	Size	A (mm.)	B (mm.)	C (mm.)
UI-F/FSSCC-44-4050	1/2"	133	116	48
UI-F/FSSCC-44-4075	3/4"	133	116	48

**MATERIALS :** ALUMINIUM ALLOY  
CAST IRON  
**FINISHING :** POWDER COATING  
HOT DIP GALVANIZED

## OUTLET BOXES FOR BALL FLANGE

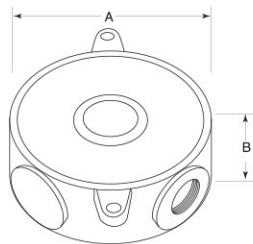

Code No.	Size	A (mm.)	B (mm.)
UI-JBC/35	1/2-3/4"	104	38.34
UI-JBC/36	1/2-3/4"	104	38.34
UI-JBC/37	1/2-3/4"	104	38.34
UI-JBC/38	1/2-3/4"	104	38.34

**MATERIALS :** ALUMINIUM ALLOY  
**FINISHING :** POWDER COATING

## BALL FLANGE

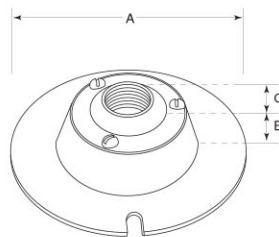

Code No.	Size	A (mm.)	B (mm.)	C (mm.)
UI-JBC/36	1/2-3/4"	104	21.63	22.2

**MATERIALS :** ALUMINIUM ALLOY  
**FINISHING :** POWDER COATING

## FLOOR OUTLET SQUARE BOX

Code No.	A (mm.)	B (mm.)	C (mm.)	D (mm.)	E (mm.)
UI-FOB-115	104.50	114.50	5.00	3.00	73.00
UI-FOB-135	120.50	113.70	5.00	3.30	95.50

## MATERIALS

COVER : **STANDARD** - ALUMINIUM

- BRASS

**SPECIAL** - BRASS WITH CROME

HOLDER : ALUMINIUM

\*\*NON SLOPE MODEL AVAILABLE BY REQUEST

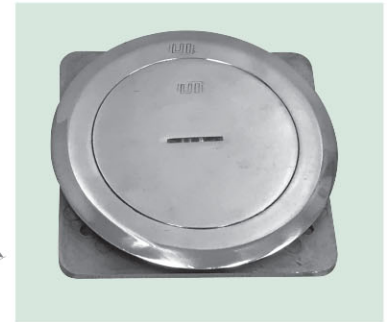
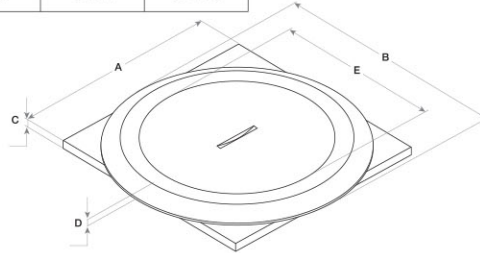

## WIRENUT

Code No.	No.	Colour (สี)	Capacity (ขนาดสาย)
WN33-033	33	สีบ	2 x 1.5 mm.
WN33-044	44	เหลือง	2 x 4 mm.
WN33-066	66	แดง	2 x 6 mm.
WN33-099	99	เทา	2 x 10 mm.



## CUSSTON / HEAVY DUTY CABLE LUBRICANT



CUSSTON

Packing	Code No.
1 GALLON	Y-2000

GOOD LUBRICANT FOR EVERYDAY USE IN  
GENERAL ELECTRICAL APPLICATIONS.  
COMPLETE CLEANUP POSSIBLE WITH WATER.





**GR CONDUIT OUTLET BOXES  
(1 WAY)**

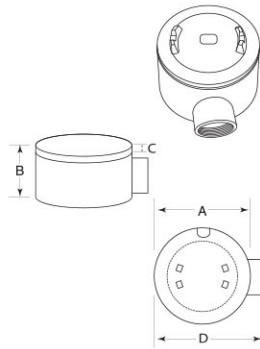

Code No.	Size	A (mm.)	B (mm.)	C (mm.)	D (mm.)
UI-F/GRE-34-050	1/2"	81.50	44.46	3.34	106.33
UI-F/GRE-34-075	3/4"	81.50	44.46	3.34	107.75
UI-F/GRE-34-100	1"	81.50	44.46	3.92	110.97

**MATERIALS :** ALUMINIUM ALLOY, CAST IRON

**FINISHING :** POWDER COATING, HOT DIP GALVANIZED

**GR CONDUIT OUTLET BOXES  
(2 WAY) 90 Degree**

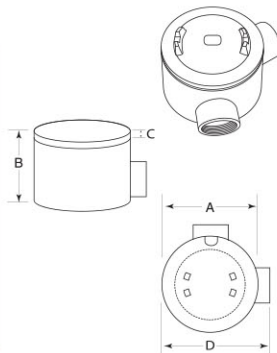

Code No.	Size	A (mm.)	B (mm.)	C (mm.)	D (mm.)
UI-F/GRE-L34-050	1/2"	81.50	44.46	3.58	95.92
UI-F/GRE-L34-075	3/4"	81.50	44.46	3.58	95.92
UI-F/GRE-L34-100	1"	81.50	51.98	3.58	95.92

**MATERIALS :** ALUMINIUM ALLOY, CAST IRON

**FINISHING :** POWDER COATING, HOT DIP GALVANIZED

**GR CONDUIT OUTLET BOXES  
(2 WAY)**

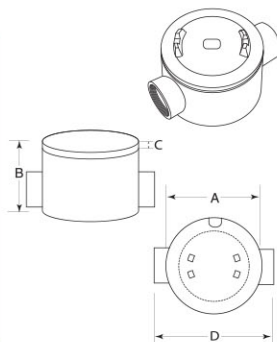

Code No.	Size	A (mm.)	B (mm.)	C (mm.)	D (mm.)
UI-F/GRC-L34-050	1/2"	81.50	44.46	3.58	107.75
UI-F/GRC-L34-075	3/4"	81.50	44.46	3.58	107.75
UI-F/GRC-L34-100	1"	81.50	51.98	3.58	107.97

**MATERIALS :** ALUMINIUM ALLOY, CAST IRON

**FINISHING :** POWDER COATING, HOT DIP GALVANIZED

**GR CONDUIT OUTLET BOXES  
(4 WAY)**

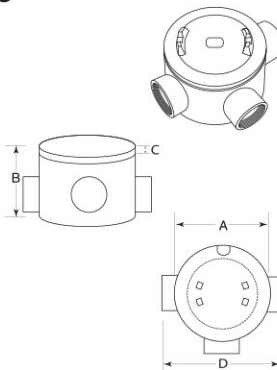

Code No.	Size	A (mm.)	B (mm.)	C (mm.)	D (mm.)
UI-F/GRT-34-050	1/2"	81.50	44.46	3.58	107.75
UI-F/GRT-34-075	3/4"	81.50	44.46	3.58	107.75
UI-F/GRT-34-100	1"	81.50	44.46	3.58	107.97

**MATERIALS :** ALUMINIUM ALLOY, CAST IRON

**FINISHING :** POWDER COATING, HOT DIP GALVANIZED

**GR CONDUIT OUTLET BOXES  
(4 WAY)**

Code No.	Size	A (mm.)	B (mm.)	C (mm.)	D (mm.)
UI-F/GRX-34-050	1/2"	81.50	44.46	3.58	107.75
UI-F/GRX-34-075	3/4"	81.50	44.46	3.58	107.75
UI-F/GRX-34-100	1"	81.50	51.98	3.58	107.97

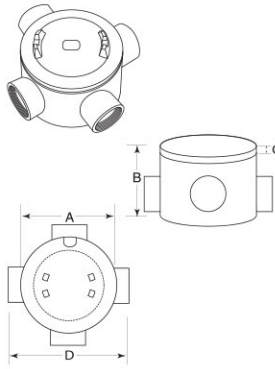

**MATERIALS** : ALUMINIUM ALLOY, CAST IRON  
**FINISHING** : POWDER COATING, HOT DIP GALVANIZED

**SPLIT HANGER WITH  
SWIVEL ADJUSTER FOR STEEL PIPES**



Code No.	Size
UI-SH-15	1/2"
UI-SH-20	3/4"
UI-SH-25	1"
UI-SH-32	1 1/4"
UI-SH-40	1 1/2"
UI-SH-50	2"
UI-SH-65	2 1/2"
UI-SH-80	3"
UI-SH-100	4"
UI-SH-125	5"
UI-SH-150	6"

**SWIVEL ADJUSTER**



Code No.	Size
UI-SJ-15	3/8"
UI-SJ-20	1/2"
UI-SJ-25	5/8"-38S
UI-SJ-30	5/8"-50L

**CLEVIS HANGER**



Code No.	For Stud Bolt	Pipe Size
UI-CH-15	1/4"	3/4"
UI-CH-20	1/4"	1"
UI-CH-25	1/4"	1 1/4"
UI-CH-30	5/16"	1 1/2"
UI-CH-35	5/16"	2"
UI-CH-40	3/8"	2 1/2"
UI-CH-45	3/8"	3"
UI-CH-50	3/8"	4"
UI-CH-55	1/2"	5"
UI-CH-60	1/2"	6"
UI-CH-65	5/8"	8"
UI-CH-70	3/4"	10"
UI-CH-75	3/4"	12"
UI-CH-80	7/8"	14"
UI-CH-85	7/8"	16"

SQUARE BOXES

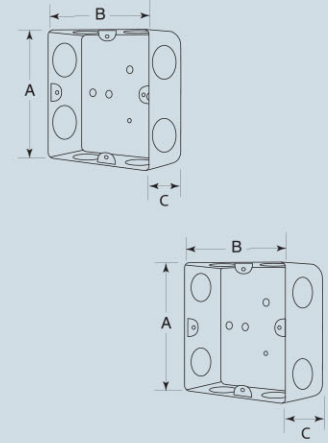

Code No.	size	A (mm.)	B (mm.)	C (mm.)
UI-SQB-HD 44-3001	4" x 4" x 1 1/2"	99.98	99.98	36.65
UI-SQB-HD 44-3002	4" x 4" x 2"	99.98	99.98	50.34

**MATERIALS :** STEEL SHEET 1.2 mm.  
STEEL SHEET 1.6 mm.  
(upon request)  
**FINISHING :** HOT DIP GALVANIZED

OCTAGON BOXES

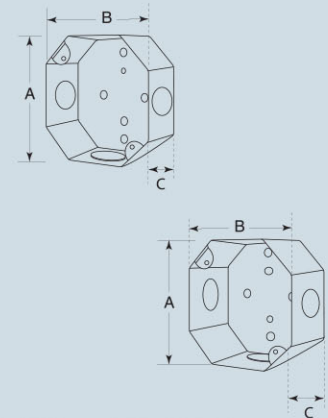
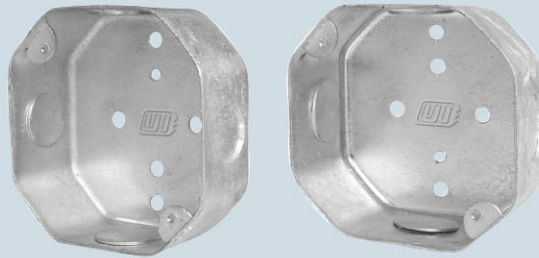

Code No.	size	A (mm.)	B (mm.)	C (mm.)
UI-OGB-HD 44-3001	4" x 4" x 1 1/2"	92.81	92.81	37.68
UI-OGB-HD 44-3002	4" x 4" x 2"	92.81	92.81	50.34

**MATERIALS :** STEEL SHEET 1.2 mm.  
STEEL SHEET 1.6 mm.  
(upon request)  
**FINISHING :** HOT DIP GALVANIZED

HANDY BOXES

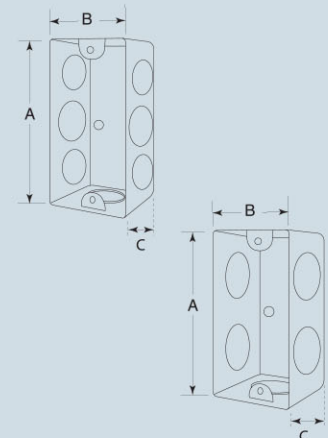

Code No.	size	A (mm.)	B (mm.)	C (mm.)
UI-HB-HD 44-3001	2" x 4"	98.84	52.88	37.65
UI-HB-HD 44-3002	2" x 4"	98.84	52.88	50.34

**MATERIALS :** STEEL SHEET 1.2 mm.  
STEEL SHEET 1.6 mm.  
(upon request)  
**FINISHING :** HOT DIP GALVANIZED

GR CONDUIT OUTLET BOXES  
(1 WAY)

Code No.	Size	A (mm.)	B (mm.)	C (mm.)	D (mm.)
UI-F/GRE-33-050	1/2"	81.50	44.46	3.34	106.33
UI-F/GRE-33-075	3/4"	81.50	44.46	3.34	107.75
UI-F/GRE-33-100	1"	81.50	44.46	3.92	110.97

**MATERIALS :** CAST IRON , ALUMINIUM ALLOY

**FINISHING :** EPOXY POWDER COATING

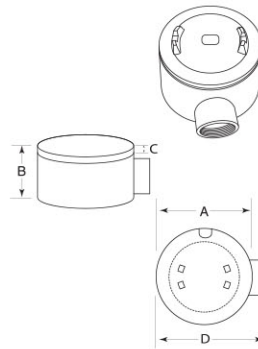
GR CONDUIT OUTLET BOXES  
(2 WAY)

Code No.	Size	A (mm.)	B (mm.)	C (mm.)	D (mm.)
UI-F/GRE-L-33-050	1/2"	81.50	44.46	3.58	95.92
UI-F/GRE-L-33-075	3/4"	81.50	44.46	3.58	95.92
UI-F/GRE-L33-100	1"	81.50	51.98	3.58	95.92

**MATERIALS :** CAST IRON , ALUMINIUM ALLOY

**FINISHING :** EPOXY POWDER COATING

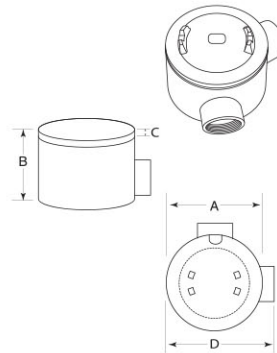
GR CONDUIT OUTLET BOXES  
(2 WAY)

Code No.	Size	A (mm.)	B (mm.)	C (mm.)	D (mm.)
UI-F/GRC-L33-050	1/2"	81.50	44.46	3.58	107.75
UI-F/GRC-L33-075	3/4"	81.50	44.46	3.58	107.75
UI-F/GRC-L33-100	1"	81.50	51.98	3.58	107.97

**MATERIALS :** CAST IRON , ALUMINIUM ALLOY

**FINISHING :** EPOXY POWDER COATING

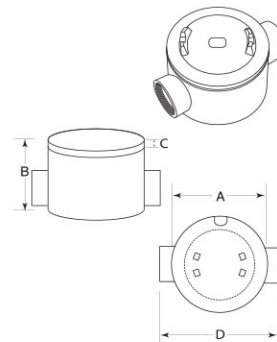
GR CONDUIT OUTLET BOXES  
(4 WAY)

Code No.	Size	A (mm.)	B (mm.)	C (mm.)	D (mm.)
UI-F/GRT-33-050	1/2"	81.50	44.46	3.58	107.75
UI-F/GRT-33-075	3/4"	81.50	44.46	3.58	107.75
UI-F/GRT-33-100	1"	81.50	44.46	3.58	107.97

**MATERIALS :** CAST IRON , ALUMINIUM ALLOY

**FINISHING :** EPOXY POWDER COATING

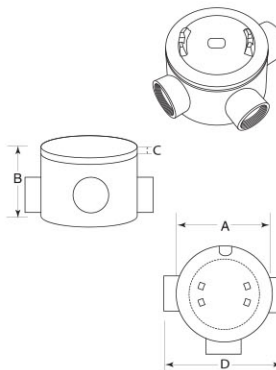

**GR CONDUIT OUTLET BOXES  
(4 WAY)**

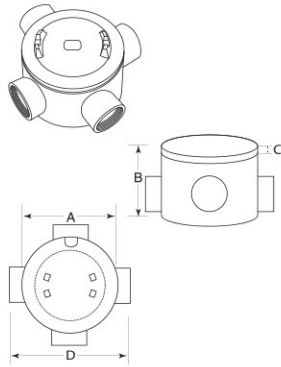
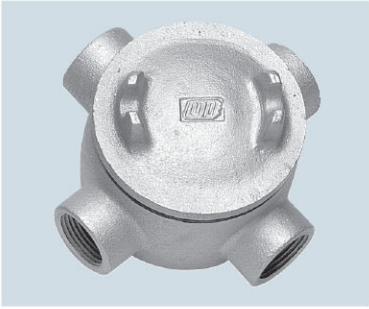

Code No.	Size	A (mm.)	B (mm.)	C (mm.)	D (mm.)
UI-F/GRX-33-050	1/2"	81.50	44.46	3.58	107.75
UI-F/GRX-33-075	3/4"	81.50	44.46	3.58	107.75
UI-F/GRX-33-100	1"	81.50	51.98	3.58	107.97

**MATERIALS :** CAST IRON, ALUMINIUM ALLOY  
**FINISHING :** EPOXY POWDER COATING

**SEH CONDUIT OUTLET BOXES AND COVER  
(2 WAY)**

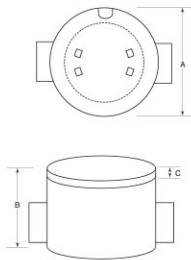

**MATERIALS :** ALUMINIUM ALLOYED, CAST IRON  
**FINISHING :** HOT DIP GALVANIZED, POWDER COATING

**SEH CONDUIT OUTLET BOXES AND COVER  
(2 WAY)**

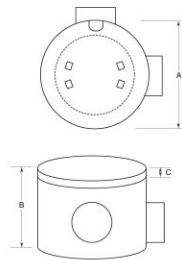

**MATERIALS :** ALUMINIUM ALLOYED, CAST IRON  
**FINISHING :** HOT DIP GALVANIZED, POWDER COATING

**SEH CONDUIT OUTLET BOXES AND COVER  
(3 WAY)**

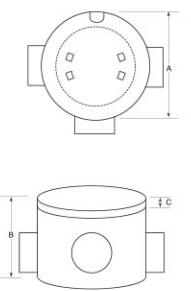

**MATERIALS :** ALUMINIUM ALLOYED, CAST IRON  
**FINISHING :** HOT DIP GALVANIZED, POWDER COATING

**SEH CONDUIT OUTLET BOXES AND COVER  
(4 WAY)**

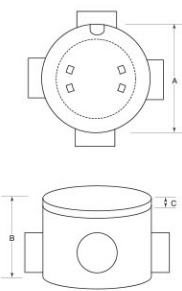

**MATERIALS :** ALUMINIUM ALLOYED, CAST IRON  
**FINISHING :** HOT DIP GALVANIZED, POWDER COATING

Code No.	Size	A (mm.)	B (mm.)	C (mm.)
UI-JB/SEHC-44-050	1/2"	101.75	49.85	55.78
UI-JB/SEHL-44-050	1/2"	101.75	49.85	55.78
UI-JB/SEHT-44-050	1/2"	101.75	49.85	55.78
UI-JB/SEHX-44-050	1/2"	101.75	49.85	55.78
UI-JB/SEHC-44-075	3/4"	101.75	49.85	55.78
UI-JB/SEHL-44-075	3/4"	101.75	49.85	55.78

Code No.	Size	A (mm.)	B (mm.)	C (mm.)
UI-JB/SEHT-44-075	3/4"	101.75	49.85	55.78
UI-JB/SEHX-44-075	3/4"	101.75	49.85	55.78
UI-JB/SEHC-44-100	1"	101.75	49.85	55.78
UI-JB/SEHL-44-100	1"	101.75	49.85	55.78
UI-JB/SEHT-44-100	1"	101.75	49.85	55.78
UI-JB/SEHX-44-100	1"	101.75	49.85	55.78

**CONDUIT OUTLET (LB)**

Code No.	Size	A (mm.)	B (mm.)	C (mm.)
UI-LB/CIH-44-050	1/2"	105	38	25
UI-LB/CIH-44-075	3/4"	124	45	33
UI-LB/CIH-44-100	1"	143	52	40
UI-LB/CIH-44-125	1 1/4"	155	57	49
UI-LB/CIH-44-150	1 1/2"	185	68	55
UI-LB/CIH-44-200	2"	233	78	70
UI-LB/CIH-44-250	2 1/2"	255	83	92
UI-LB/CIH-44-300	3"	290	105	101
UI-LB/CIH-44-300	3 1/2"	350	138	119
UI-LB/CIH-44-400	4"	350	138	119

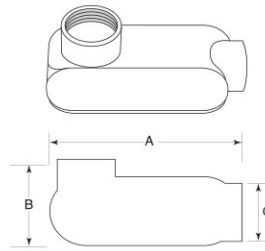

**MATERIALS :** CAST IRON  
**FINISHING :** HOT DIP GALVANIZED, EPOXY POWDER COATING

**CONDUIT OUTLET (LL)**

Code No.	Size	A (mm.)	B (mm.)	C (mm.)
UI-LL/CIH-44-050	1/2"	105	38	25
UI-LL/CIH-44-075	3/4"	124	45	33
UI-LL/CIH-44-100	1"	143	52	40
UI-LL/CIH-44-125	1 1/4"	155	57	49
UI-LL/CIH-44-150	1 1/2"	185	68	55
UI-LL/CIH-44-200	2"	233	78	70
UI-LL/CIH-44-250	2 1/2"	255	83	92
UI-LL/CIH-44-300	3"	290	105	101
UI-LL/CIH-44-300	3 1/2"	350	138	119
UI-LL/CIH-44-400	4"	350	138	119

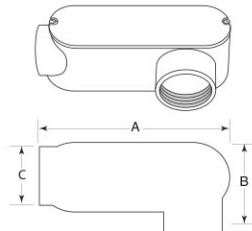

**MATERIALS :** CAST IRON  
**FINISHING :** HOT DIP GALVANIZED, EPOXY POWDER COATING

**CONDUIT OUTLET (LR)**

Code No.	Size	A (mm.)	B (mm.)	C (mm.)
UI-LR/CIH-44-050	1/2"	105	38	25
UI-LR/CIH-44-075	3/4"	124	45	33
UI-LR/CIH-44-100	1"	143	52	40
UI-LR/CIH-44-125	1 1/4"	155	57	49
UI-LR/CIH-44-150	1 1/2"	185	68	55
UI-LR/CIH-44-200	2"	233	78	70
UI-LR/CIH-44-250	2 1/2"	255	83	92
UI-LR/CIH-44-300	3"	290	105	101
UI-LR/CIH-44-300	3 1/2"	350	138	119
UI-LR/CIH-44-400	4"	350	138	119

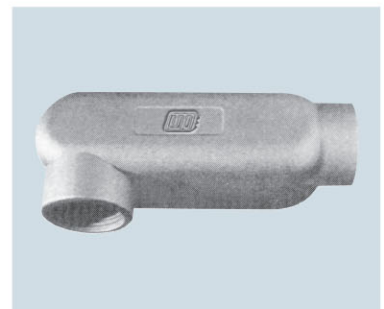
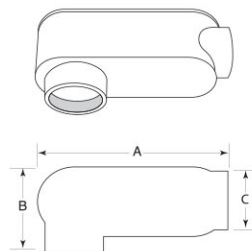

**MATERIALS :** CAST IRON  
**FINISHING :** HOT DIP GALVANIZED, EPOXY POWDER COATING

**CONDUIT OUTLET (OT)**

Code No.	Size	A (mm.)	B (mm.)	C (mm.)
UI-OT/CIH-44-050	1/2"	120	38	28
UI-OT/CIH-44-075	3/4"	139	48	33
UI-OT/CIH-44-100	1"	148	52	40
UI-OT/CIH-44-125	1 1/4"	165	59	48
UI-OT/CIH-44-150	1 1/2"	188	62	55
UI-OT/CIH-44-200	2"	237	78	70
UI-OT/CIH-44-250	2 1/2"	263	92	83

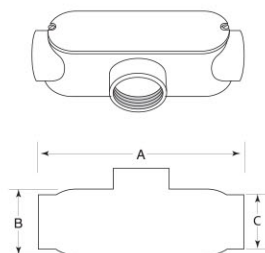

**MATERIALS :** CAST IRON  
**FINISHING :** HOT DIP GALVANIZED, EPOXY POWDER COATING

## BUSHING

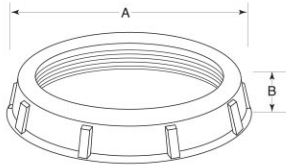

Code No.	Size	A (mm.)	B (mm.)
UI-CI-BHD44-050	1/2"	26.8	8.54
UI-CI-BHD44-075	3/4"	31.49	9.49
UI-CI-BHD44-100	1"	37.54	11.21
UI-CI-BHD44-125	1 1/4"	47.89	12.72
UI-CI-BHD44-150	1 1/2"	53.98	12
UI-CI-BHD44-200	2"	64.69	12.68

Code No.	Size	A (mm.)	B (mm.)
UI-CI-BHD44-250	2 1/2"	79.58	15.22
UI-CI-BHD44-300	3"	94.48	17.46
UI-CI-BHD44-350	3 1/2"	112.15	21.27
UI-CI-BHD44-400	4"	121.58	20.6
UI-CI-BHD44-500	5"	157	24

**MATERIALS** : CAST IRON  
**FINISHING** : HOT DIP GALVANIZED

## LOCKNUT

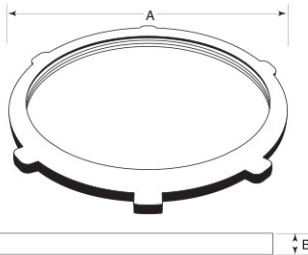

Code No.	Size	A (mm.)	B (mm.)
UI-LNC-HD-44-050	1/2"	29.5	2.09
UI-LNC-HD-44-075	3/4"	35.87	2.32
UI-LNC-HD-44-100	1"	44.9	2.32
UI-LNC-HD-44-125	1 1/4"	52.78	2.9
UI-LNC-HD-44-150	1 1/2"	62.03	3.5
UI-LNC-HD-44-200	2"	73.49	23.24

Code No.	Size	A (mm.)	B (mm.)
UI-LNC-HD-44-250	2 1/2"	88.15	3.55
UI-LNC-HD-44-300	3"	106.54	4.01
UI-LNC-HD-44-350	3 1/2"	120.16	3.81
UI-LNC-HD-44-400	4"	133.9	3.88
UI-LNC-HD-44-500	5"	158.26	18.4
UI-LNC-HD-44-600	6"	188.12	18.45

**MATERIALS** : CAST IRON  
**FINISHING** : HOT DIP GALVANIZED

## I.M.C. STRAP-2-HOLE

แกล้มปีจับท่อทวน

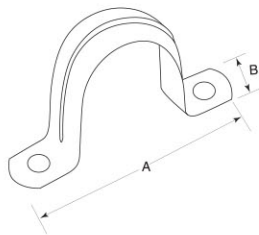

Code No.	Size	A (mm.)	B (mm.)
UI-2HHD-44-050	1/2"	67.70	15.00
UI-2HHD-44-075	3/4"	64.60	15.00
UI-2HHD-44-100	1"	73.50	15.00
UI-2HHD-44-125	1 1/4"	82.60	20.00
UI-2HHD-44-150	1 1/2"	87.73	20.00
UI-2HHD-44-200	2"	118.40	20.00
UI-2HHD-44-250	2 1/2"	134.20	25.00
UI-2HHD-44-300	3"	165.50	25.00
UI-2HHD-44-400	4"	192.80	25.00

**MATERIALS** : STEEL SHEET  
**FINISHING** : HOT DIP GALVANIZED

**E.M.T. STRAP-2-HOLE**

แคลมป์จับท่อหนา

Code No.	Size	A (mm.)	B (mm.)
UI-2HEHD-44-050	1/2"	53.43	15.00
UI-2HEHD-44-075	3/4"	64.09	15.00
UI-2HEHD-44-100	1"	73.50	15.00
UI-2HEHD-44-125	1 1/4"	80.62	20.00
UI-2HEHD-44-150	1 1/2"	95.15	20.00
UI-2HEHD-44-200	2"	107.10	20.00

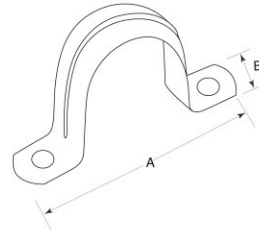

**MATERIALS** : STEEL SHEET  
**FINISHING** : HOT DIP GALVANIZED

Code No.	Size	A (mm.)	B (mm.)
UI-IPHD-44-050	1/2"	45.89	20.8
UI-IPHD-44-075	3/4"	52.31	26.3
UI-IPHD-44-100	1"	60.91	32.7
UI-IPHD-44-125	1 1/4"	68.86	41.9
UI-IPHD-44-150	1 1/2"	74.23	48.0
UI-IPHD-44-200	2"	88.07	60.1
UI-IPHD-44-250	2 1/2"	107.38	72.8
UI-IPHD-44-300	3"	122.51	88.5
UI-IPHD-44-350	3 1/2"	148.26	101.1
UI-IPHD-44-400	4"	153.19	113.7

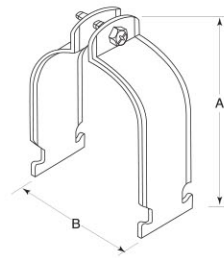
**I.M.C. PIPE CLAMPS**

แคลมป์ประกับไอเอ็มซี



**MATERIALS** : STEEL SHEET  
**FINISHING** : HOT DIP GALVANIZED

Code No.	Size	A (mm.)	B (mm.)
UI-EPHD-44-050	1/2"	42.8	17.93
UI-EPHD-44-075	3/4"	50.44	23.42
UI-EPHD-44-100	1"	56.05	29.54
UI-EPHD-44-125	1 1/4"	66.48	38.35
UI-EPHD-44-150	1 1/2"	71.14	44.20
UI-EPHD-44-200	2"	87.63	55.80

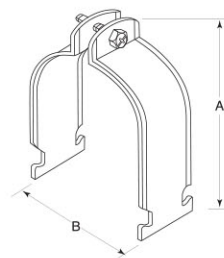
**E.M.T. PIPE CLAMPS**

แคลมป์ประกับอีเอ็มซี



**MATERIALS** : STEEL SHEET  
**FINISHING** : HOT DIP GALVANIZED

Code No.	Size	Code No.	Size
UI-CIP-HD-44-050	1/2"	UI-CIP-HD-44-150	1 1/2"
UI-CIP-HD-44-075	3/4"	UI-CIP-HD-44-200	2"
UI-CIP-HD-44-100	1"	UI-CIP-HD-44-250	2 1/2"
UI-CIP-HD-44-125	1 1/4"		

**MATERIALS** : CAST IRON  
**FINISHING** : HOT DIP GALVANIZED

**HUD PLATES**