



✓ โฉนตหนัก (Heavy Duty)



SPECIFICATION

- Standard : IEC / EN60947
- Rated operation current : 16A
- Rated insulating voltage : 690V
- Rated impulse withstand voltage(Uimp) : 6kV
- Frequency : 50/60Hz
- Front protection : IP20
- Mechanical life : 100,000 operation at 300 cycles/hour.
- Electrical life : 10,000 operation at 120 cycles/hour.

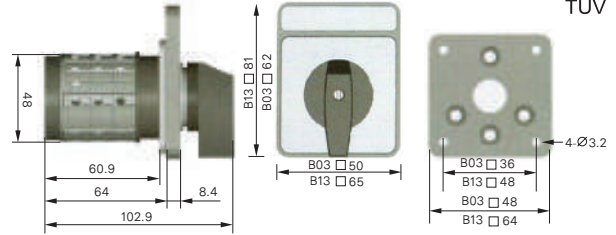

SA16-4-61325-A03



SA16-4-61325-B03



SA16-4-61325-A13



SA16-4-61325-B13

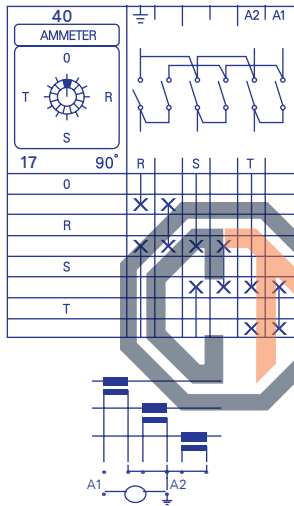

แอมป์มิเตอร์สวิตช์ (Ammeter Switches - Heavy Duty)

รุ่น (Model)	Rated(AC-23A/B)			Mounting size	Script plate marking size	ราคา (บาท)
	Current	Voltage	KW			
SA16-4-61325-A03	16A	380-440V	5.5KW	48x48mm.	48x60 mm.	450.-
SA16-4-61325-B03	16A	380-440V	5.5KW	48x48mm.	48x60 mm.	430.-
SA16-4-61325-A13	16A	380-440V	5.5KW	64x64mm.	64x80 mm.	470.-
SA16-4-61325-B13	16A	380-440V	5.5KW	64x64mm.	64x80 mm.	450.-



SA16-7-61313-A03



SA16-7-61313-B03



SA16-7-61313-A13



SA16-7-61313-B13

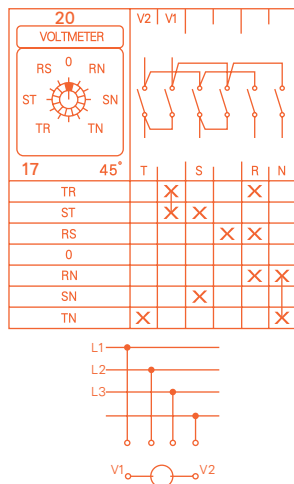

โวลต์มิเตอร์สวิตช์ (Voltmeter Switches - Heavy Duty)

รุ่น (Model)	Rated(AC-23A/B)			Mounting size	Script plate marking	ราคา (บาท)
	Current	Voltage	KW			
SA16-7-61313-A03	16A	380-440V	5.5KW	48x48mm.	48x60 mm.	450.-
SA16-7-61313-B03	16A	380-440V	5.5KW	48x48mm.	48x60 mm.	430.-
SA16-7-61313-A13	16A	380-440V	5.5KW	64x64mm.	64x80 mm.	470.-
SA16-7-61313-B13	16A	380-440V	5.5KW	64x64mm.	64x80 mm.	450.-

* ราคาสินค้าไม่รวมภาษีมูลค่าเพิ่มและราคาอาจเปลี่ยนแปลงได้โดยไม่ต้องแจ้งให้ทราบล่วงหน้า *

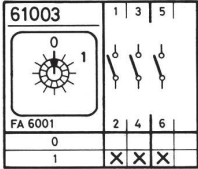

On/Off Switches

สวิตช์เปิด-ปิด (ON-OFF Switches)

รุ่น (Model)	Pole	Rated Current (AC-21A)		Capacity 3Phase (AC-3)		Size (mm.)	ราคา (บาท)
		240V	440V	240V	440V		
SA16-2-2/61003-B03	3P	16A	16A	3kW	5.5kW	48 x 48	500.-
SA16-2-2/61003-B13	3P	16A	16A	3kW	5.5kW	64 x 64	580.-
SA25-2-2/61003-B13	3P	25A	25A	4kW	7.5kW	64 x 64	940.-
SA32-2-2/61003-B13	3P	32A	32A	5.5kW	11kW	64 x 64	1,080.-
SA63-2-2/61003-B13	3P	63A	63A	11kW	18.5kW	64 x 64	1,800.-

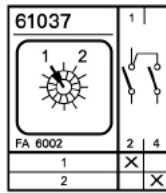

SA16-2-1/61037-B03

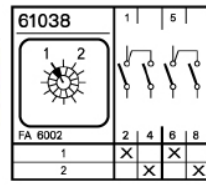

SA16-2-2/61038-B03

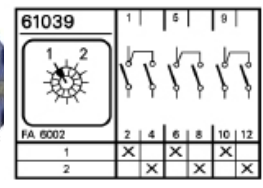

SA16-2-3/61039-B03

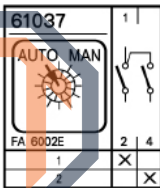

SA16-2-1/61037-B03E

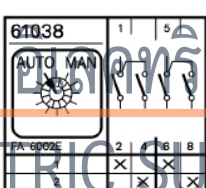

SA16-2-2/61038-B03E

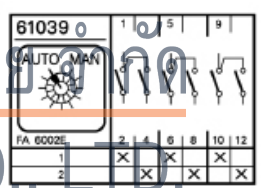

SA16-2-3/61039-B03E

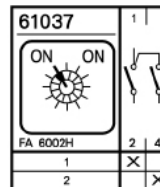

SA16-2-1/61037-B03H

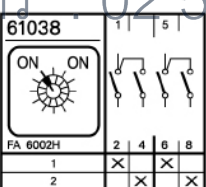
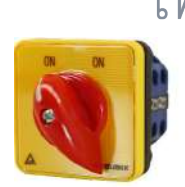

SA16-2-2/61038-B03H

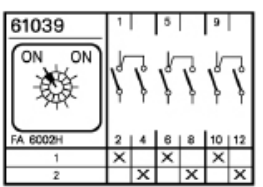

SA16-2-3/61039-B03H

สวิตช์สับเปลี่ยนสองทางไม่มีตำแหน่งปิด (Change Over Switches Without Off)

รุ่น (Model)	Pole	Rated Current (AC-21A)		Capacity 3Phase (AC-3)		Size (mm.)	Script plate marking	ราคา (บาท)
		240V	440V	240V	440V			
SA16-2-1/61037-B03	1P	16A	16A	3kW	5.5kW	48x48		350.-
SA16-2-2/61038-B03	2P	16A	16A	3kW	5.5kW	48x48		650.-
SA16-2-3/61039-B03	3P	16A	16A	3kW	5.5kW	48x48		940.-
SA16-2-1/61037-B03E	1P	16A	16A	3kW	5.5kW	48x48		350.-
SA16-2-2/61038-B03E	2P	16A	16A	3kW	5.5kW	48x48		650.-
SA16-2-3/61039-B03E	3P	16A	16A	3kW	5.5kW	48x48		940.-
SA16-2-1/61037-B03H	1P	16A	16A	3kW	5.5kW	48x48		350.-
SA16-2-2/61038-B03H	2P	16A	16A	3kW	5.5kW	48x48		650.-
SA16-2-3/61039-B03H	3P	16A	16A	3kW	5.5kW	48x48		940.-

* ราคาสินค้าไม่รวมภาษีมูลค่าเพิ่มและราคาอาจเปลี่ยนแปลงได้โดยไม่ต้องแจ้งให้ทราบล่วงหน้า *



SA16-3-1/61025-B03



SA16-3-2/61026-B03



SA16-3-3/61027-B03



SA16-3-1/61025-B03E



SA16-3-2/61026-B03E



SA16-3-3/61027-B03E



SA16-3-1/61025-B03H

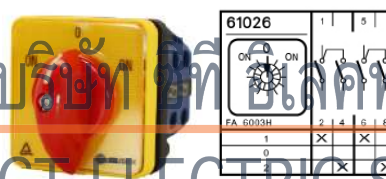

SA16-3-2/61026-B03H



SA16-3-3/61027-B03H

บริษัท ซีเล็คทริกซัพพลาย จำกัด
CT ELECTRIC SUPPLY CO., LTD.

โทร : 02 550 9555

สวิตซ์สับเปลี่ยนสองทางมีตำแหน่งปิด (Change Over Switches With Off)

รุ่น (Model)	Pole	Rated Current (AC-21A)		Capacity 3Phase (AC-3)		Size (mm.)	Script plate marking	ราคา (บาท)
		240V	440V	240V	440V			
SA16-3-1/61025-B03	1P	16A	16A	3kW	5.5kW	48x48		350.-
SA16-3-2/61026-B03	2P	16A	16A	3kW	5.5kW	48x48		650.-
SA16-3-3/61027-B03	3P	16A	16A	3kW	5.5kW	48x48		940.-
SA16-3-3/61027-B13	3P	16A	16A	3kW	5.5kW	64x64		1,000.-
SA25-3-3/61027-B13	3P	25A	25A	4kW	7.5kW	64x64		1,340.-
SA32-3-3/61027-B13	3P	32A	32A	5.5kW	11kW	64x64		1,500.-
SA63-3-3/61027-B13	3P	63A	63A	11kW	18.5kW	64x64		2,400.-
SA125-3-3/61027-B013	3P	100A	100A	15kW	30kW	88x88	4,200.-	
SA16-3-1/61025-B03E	1P	16A	16A	3kW	5.5kW	48x48		350.-
SA16-3-2/61026-B03E	2P	16A	16A	3kW	5.5kW	48x48		650.-
SA16-3-3/61027-B03E	3P	16A	16A	3kW	5.5kW	48x48		940.-
SA16-3-1/61025-B03H	1P	16A	16A	3kW	5.5kW	48x48		350.-
SA16-3-2/61026-B03H	2P	16A	16A	3kW	5.5kW	48x48		650.-
SA16-3-3/61027-B03H	3P	16A	16A	3kW	5.5kW	48x48		940.-

* ราคาสินค้าไม่รวมภาษีมูลค่าเพิ่มและราคาอาจเปลี่ยนแปลงได้โดยไม่ต้องแจ้งให้ทราบล่วงหน้า *

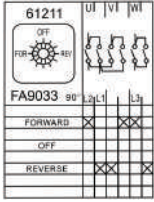

Forward Reverse Switches

สวิตช์เดินหน้า-ถอยหลัง (Forward Reverse Switches)

รุ่น (Model)	Pole	Rated Current (AC-21A)		Capacity 3Phase (AC-3)		Size (mm.)	ราคา (บาท)
		240V	440V	240V	440V		
SA16-3-3/61211-B03	3P	16A	16A	3kW	5.5kW	48 x 48	870.-
SA16-3-3/61211-B13	3P	16A	16A	3kW	5.5kW	64 x 64	920.-
SA25-3-3/61211-B13	3P	25A	25A	4kW	7.5kW	64 x 64	1,280.-
SA32-3-3/61211-B13	3P	32A	32A	5.5kW	11kW	64 x 64	1,440.-
SA63-3-3/61211-B13	3P	63A	63A	11kW	18.5kW	64 x 64	2,600.-

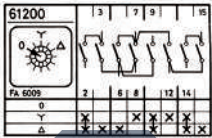

Star-Delta Switches

สวิตช์สตาร์-เดลต้า (Star-Delta Switches)

รุ่น (Model)	Pole	Rated Current (AC-21A)		Capacity 3Phase (AC-3)		Size (mm.)	ราคา (บาท)
		240V	440V	240V	440V		
SA16-3-4/61200-B03	3P	16A	16A	3kW	5.5kW	48 x 60	720.-
SA25-3-4/61200-B13	3P	16A	16A	3kW	5.5kW	64 x 80	1,200.-
SA32-3-4/61200-B13	3P	25A	25A	4kW	7.5kW	64 x 80	1,800.-
SA63-3-4/61200-B13	3P	32A	32A	5.5kW	11kW	64 x 80	2,800.-
SA125-3-4/61200-B13	3P	63A	63A	11kW	18.5kW	88 x 88	5,000.-

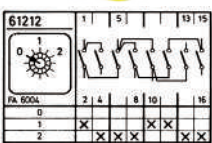
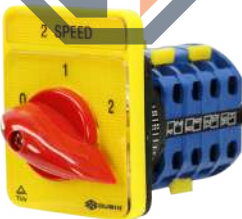

2 Speed Switches

สวิตช์ 2 สปีด (2 Speed Switches)

รุ่น (Model)	Pole	Rated Current (AC-21A)		Capacity 3Phase (AC-3)		Size (mm.)	ราคา (บาท)
		240V	440V	240V	440V		
SA16-3-4/61212-B03	3P	16A	16A	3kW	5.5kW	48 x 60	720.-
SA25-3-4/61212-B13	3P	25A	25A	4kW	7.5kW	64 x 80	1,200.-
SA32-3-4/61212-B13	3P	32A	32A	5.5kW	11kW	64 x 80	1,800.-
SA63-3-4/61212-B13	3P	63A	63A	11kW	18.5kW	64 x 80	2,800.-

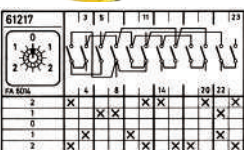

Reversing 2 Speed Switches

สวิตช์เดินหน้า-ถอยหลัง 2 สปีด (Reversing 2 Speed Switches)

รุ่น (Model)	Pole	Rated Current (AC-21A)		Capacity 3Phase (AC-3)		Size (mm.)	ราคา (บาท)
		240V	440V	240V	440V		
SA16-5-6/61217-B03	3P	16A	16A	3kW	5.5kW	48 x 60	1,200.-
SA25-5-6/61217-B13	3P	25A	25A	4kW	7.5kW	64 x 80	1,600.-
SA32-5-6/61217-B13	3P	32A	32A	5.5kW	11kW	64 x 80	2,300.-
SA63-5-6/61217-B13	3P	63A	63A	11kW	18.5kW	64 x 80	3,800.-

* ราคาสินค้าไม่รวมภาษีมูลค่าเพิ่มและราคาอาจเปลี่ยนแปลงได้โดยไม่ต้องแจ้งให้ทราบล่วงหน้า *

บริษัท ซีที อีเล็คทริค ซัพพลาย จำกัด
CT ELECTRIC SUPPLY CO., LTD.

โทร : 02-550 9555



สวิตช์มัลติสแต็ป (Multi-Step Switches with "OFF" 1 Pole)

รุ่น (Model)	Step	Pole	Rated Current (AC-21A)		Capacity 3Phase (AC-3)		Size (mm.)	ราคา (บาท)
			240V	440V	240V	440V		
SA16-3-1/61059-B03	2	1P	16A	16A	3KW	5.5KW	48x48	300.-
SA16-4-2/61060-B03	3	1P	16A	16A	3KW	5.5KW	48x48	450.-
SA16-5-2/61061-B03	4	1P	16A	16A	3KW	5.5KW	48x48	500.-
SA16-6-3/61062-B03	5	1P	16A	16A	3KW	5.5KW	48x48	650.-
SA16-7-3/61063-B03	6	1P	16A	16A	3KW	5.5KW	48x48	700.-
SA16-8-4/61064-B03	7	1P	16A	16A	3KW	5.5KW	48x48	850.-
SA16-9-4/61065-B03	8	1P	16A	16A	3KW	5.5KW	48x48	980.-
SA16-10-5/61066-B03	9	1P	16A	16A	3KW	5.5KW	48x48	1,200.-
SA16-11-5/61067-B03	10	1P	16A	16A	3KW	5.5KW	48x48	1,350.-
SA16-12-6/61068-B03	11	1P	16A	16A	3KW	5.5KW	48x48	1,500.-

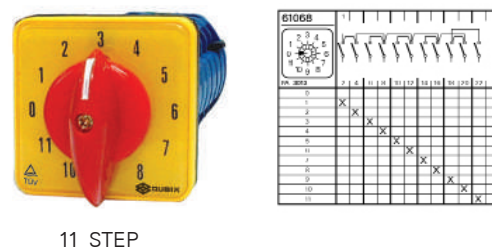
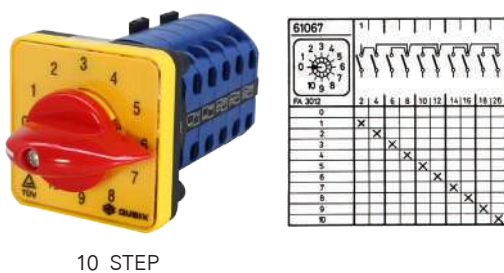
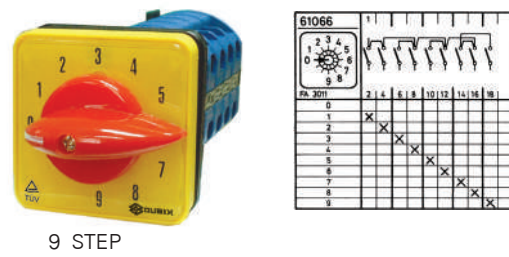
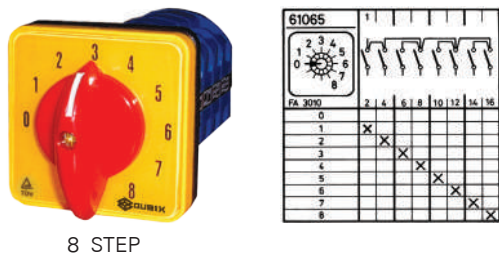
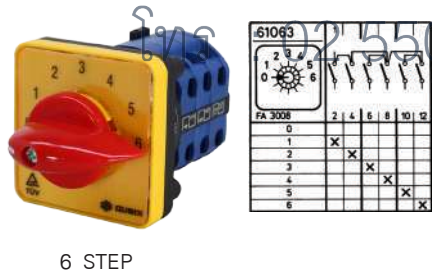
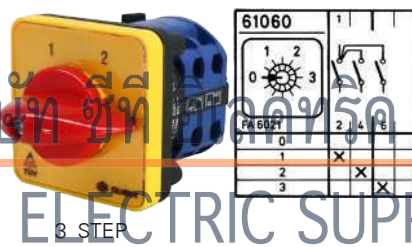
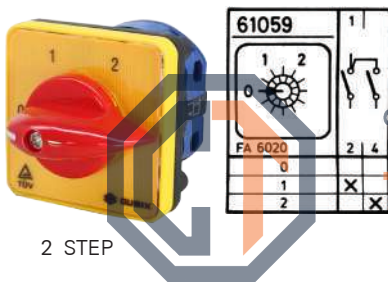

* ราคาสินค้าไม่รวมภาษีมูลค่าเพิ่มและราคาอาจเปลี่ยนแปลงได้โดยไม่ต้องแจ้งให้ทราบล่วงหน้า *

สวิตช์มัลติสแต็ป (Multi-Step Switches with "OFF" 2 Pole)

รุ่น (Model)	Step	Pole	Rated Current (AC-21A)		Capacity 3Phase (AC-3)		Size (mm.)	ราคา (บาท)
			240V	440V	240V	440V		
SA16-3-2/61079-B03	2	2P	16A	16A	3KW	5.5KW	48 x 48	500.-
SA16-4-3/61080-B03	3	2P	16A	16A	3KW	5.5KW	48 x 48	700.-
SA16-5-4/61081-B03	4	2P	16A	16A	3KW	5.5KW	48 x 48	980.-
SA16-6-5/61082-B03	5	2P	16A	16A	3KW	5.5KW	48 x 48	1,250.-
SA16-7-6/61083-B03	6	2P	16A	16A	3KW	5.5KW	48 x 48	1,550.-
SA16-8-7/61084-B03	7	2P	16A	16A	3KW	5.5KW	48 x 48	1,800.-



2 STEP

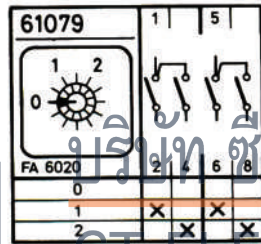

5 STEP

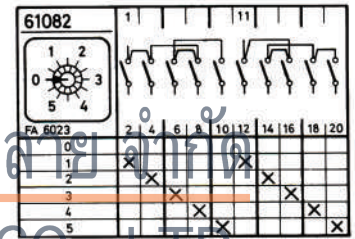

3 STEP

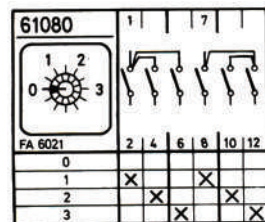

6 STEP

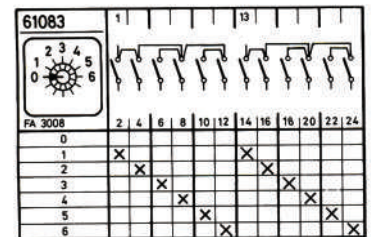

4 STEP

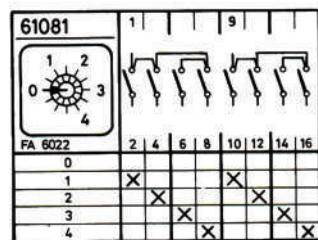

7 STEP

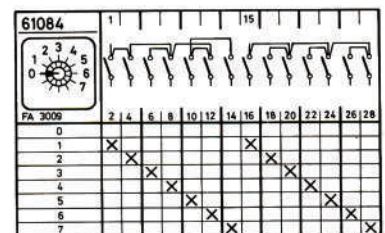

โทร : 02 550 9555

* ราคาสินค้าไม่รวมภาษีมูลค่าเพิ่มและราคาอาจเปลี่ยนแปลงได้โดยไม่ต้องแจ้งให้ทราบล่วงหน้า *



สวิตช์มัลติสแต็ป (Multi-Step Switches with "OFF" 3 Pole)

รุ่น (Model)	Step	Pole	Rated Current (AC-21A)		Capacity 3Phase (AC-3)		Size (mm.)	ราคา (บาท)
			240V	440V	240V	440V		
SA16-3-3/61099-B03	2	3P	16A	16A	3KW	5.5KW	48x48	700.-
SA16-4-5/61100-B03	3	3P	16A	16A	3KW	5.5KW	48x48	1,250.-
SA16-5-6/61101-B03	4	3P	16A	16A	3KW	5.5KW	48x48	1,500.-
SA16-6-8/61102-B03	5	3P	16A	16A	3KW	5.5KW	48x48	2,200.-
SA16-7-9/61103-B03	6	3P	16A	16A	3KW	5.5KW	48x48	2,500.-



2 STEP

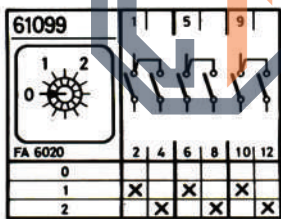

3 STEP

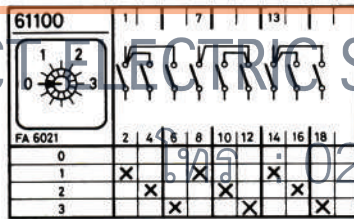

4 STEP

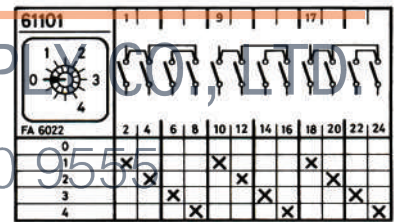

5 STEP

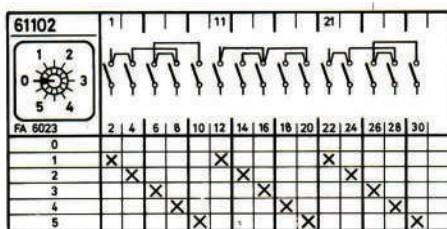

6 STEP

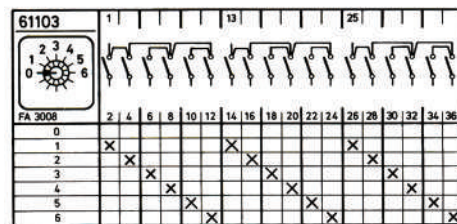

บริษัท ซีที อิเล็กทริก ซัพพลาย จำกัด
C.T. ELECTRIC SUPPLY CO., LTD.

โทร 02 550 9555

สวิตช์มัลติสเต็ป (Multi-Step Switches without "OFF" 1 Pole)



4 STEP

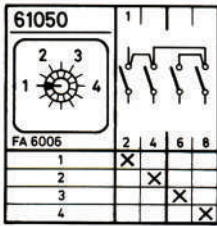

รุ่น (Model)	Step	Pole	Rated Current (AC-21A)		Capacity 3Phase (AC-3)		Size (mm.)	ราคา (บาท)
			240V	440V	240V	440V		
SA16-4-2/61050-B03	4	1P	16A	16A	3KW	5.5KW	48 x 48	500.-
SA16-5-3/61051-B03	5	1P	16A	16A	3KW	5.5KW	48 x 48	650.-
SA16-6-3/61052-B03	6	1P	16A	16A	3KW	5.5KW	48 x 48	700.-
SA16-7-4/61053-B03	7	1P	16A	16A	3KW	5.5KW	48 x 48	850.-
SA16-8-4/61054-B03	8	1P	16A	16A	3KW	5.5KW	48 x 48	980.-
SA16-9-5/61055-B03	9	1P	16A	16A	3KW	5.5KW	48 x 48	1,200.-
SA16-10-5/61056-B03	10	1P	16A	16A	3KW	5.5KW	48 x 48	1,350.-
SA16-11-6/61057-B03	11	1P	16A	16A	3KW	5.5KW	48 x 48	1,550.-
SA16-12-6/61058-B03	12	1P	16A	16A	3KW	5.5KW	48 x 48	1,650.-



5 STEP

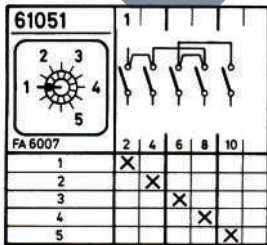

6 STEP

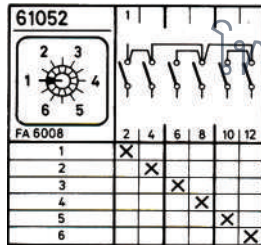

7 STEP

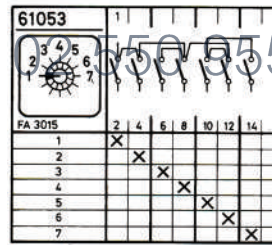

8 STEP

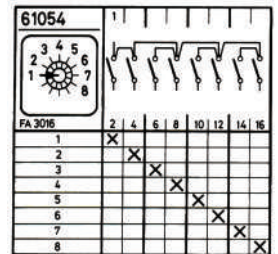

9 STEP

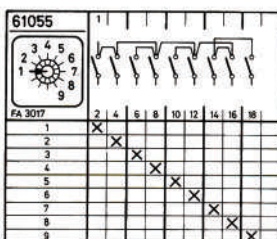

10 STEP

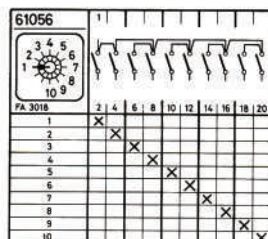

11 STEP

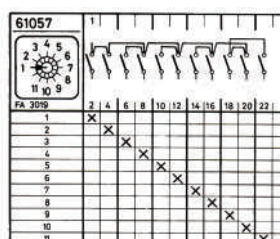

12 STEP

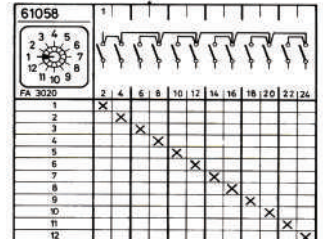

บริษัท ซีที อิเล็กทริก ซัพพลาย จำกัด
CT ELECTRIC SUPPLY CO., LTD.

โทร : 056-555555

* ราคาสินค้าไม่รวมภาษีมูลค่าเพิ่มและราคาอาจเปลี่ยนแปลงได้โดยไม่ต้องแจ้งให้ทราบล่วงหน้า *



สวิตช์มัลติสแต็ป (Multi-Step Switches without "OFF" 2 Pole)

รุ่น (Model)	Step	Pole	Rated Current (AC-21A)		Capacity 3Phase (AC-3)		Size (mm.)	ราคา (บาท)
			240V	440V	240V	440V		
SA16-4-4/61070-B03	4	2P	16A	16A	3KW	5.5KW	48 x 48	980.-
SA16-5-5/61071-B03	5	2P	16A	16A	3KW	5.5KW	48 x 48	1,250.-
SA16-6-6/61072-B03	6	2P	16A	16A	3KW	5.5KW	48 x 48	1,500.-



4 STEP



5 STEP



6 STEP

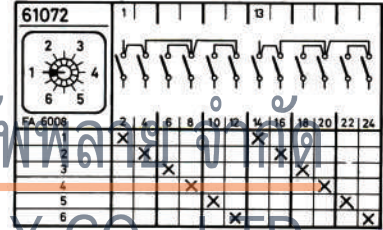
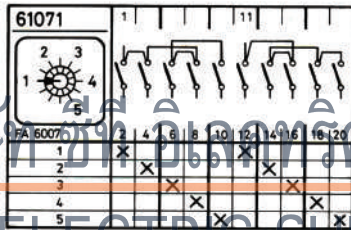
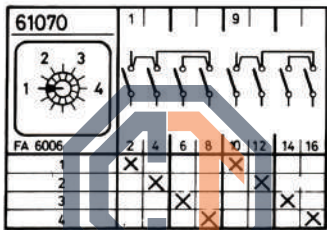

สวิตช์มัลติสแต็ป (Multi-Step Switches without "OFF" 3 Pole)

รุ่น (Model)	Step	Pole	Rated Current (AC-21A)		Capacity 3Phase (AC-3)		Size (mm.)	ราคา (บาท)
			240V	440V	240V	440V		
SA16-4-6/61090-B03	4	3P	16A	16A	3KW	5.5KW	48 x 48	1,500.-
SA16-6-9/61092-B03	6	3P	16A	16A	3KW	5.5KW	48 x 48	2,500.-
SA16-8-12/61094-B03	8	3P	16A	16A	3KW	5.5KW	48 x 48	2,900.-



4 STEP



6 STEP



8 STEP

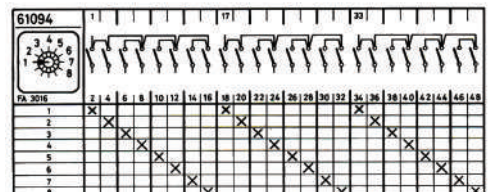
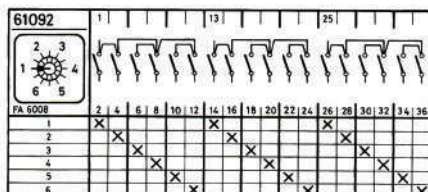
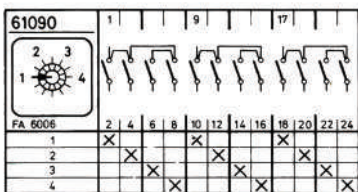

* ราคาสินค้าไม่รวมภาษีมูลค่าเพิ่มและราคาอาจเปลี่ยนแปลงได้โดยไม่ต้องแจ้งให้ทราบล่วงหน้า *

คุณลักษณะ SPECIFICATIONS

- ผลิตจากวัสดุเทอร์โมพลาสติกเกรดอุตสาหกรรม (Made of industrial grade thermoplastic ABS)
- ป้องกันน้ำและฝุ่นได้ตามมาตรฐาน IP65 และผลิตตามมาตรฐาน IEC 60947-3, GB/T 14048.3
- อุณหภูมิใช้งาน -5°C ถึง +40°C (Able to withstand a temperature range from -5°C to +40°C)
- ทนทานต่อการกัดกร่อนได้ดี (Chemical resistance to aqueous acids, alkalis, salt & sea water. Concentrated phosphoric & hydrochloric acids have little effect on ABS)

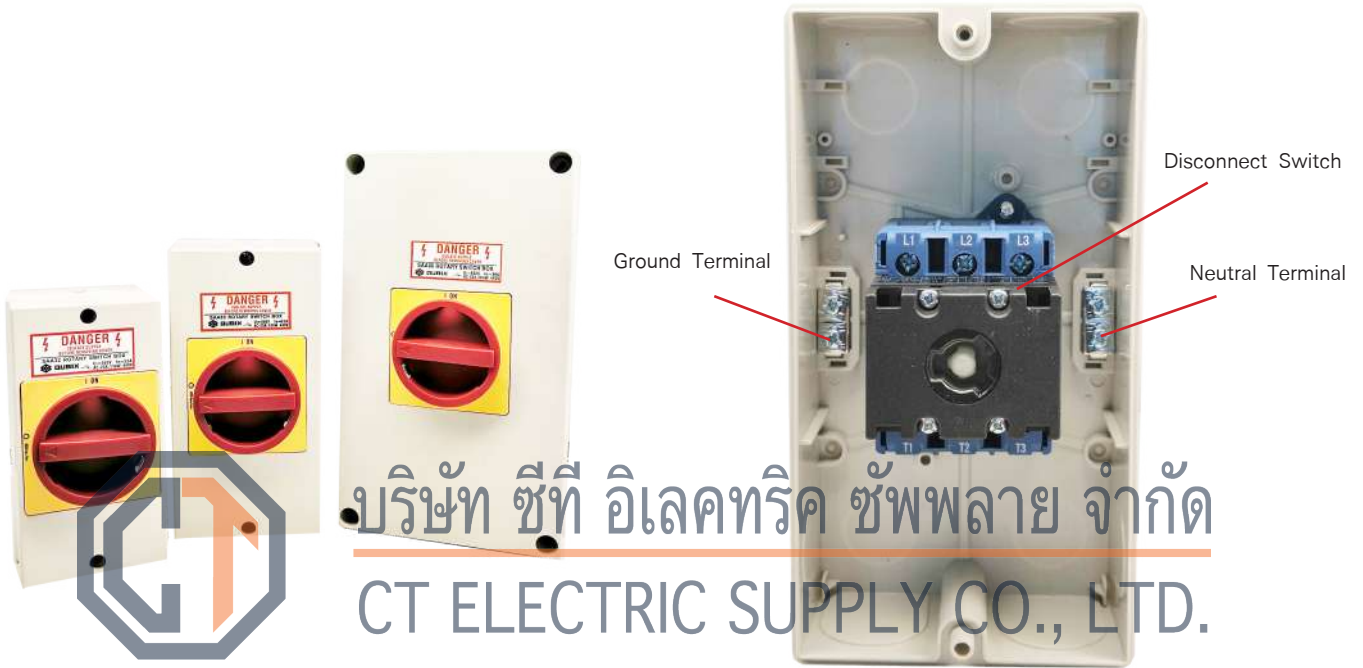

บริษัท ซีที อิเล็กทริก ซัพพลาย จำกัด
CT ELECTRIC SUPPLY CO., LTD.

โทร : 02 550 9555

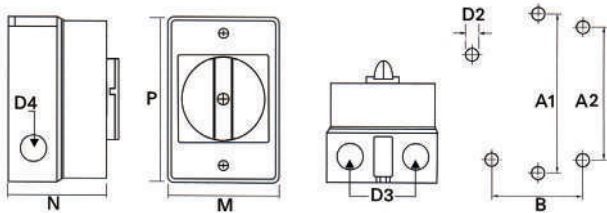

Dimension IP65 plastic box

Dimension and Installation

Description	Dimension (mm.)						Installation (mm.)		
	D3	D4	M	N	P	A1	A2	B	D2
SAA 16/3	23	19	85	80	160	150	--	--	4.1
SAA 32/3	23	19	85	80	160	150	--	--	4.1
SAA 40/3	29	23	98	91	190	178	--	--	4.1
SAA 63/3	29	23	98	91	190	178	--	--	4.1
SAA 80/3	37.5	23	145	103	250	--	232	124	4.1
SAA 100/3	37.5	23	145	103	250	--	232	124	4.1

Rotary Switches SAA-Series with Padlock IP65

Connection Diagram	รุ่น (Model)	Pole	Rated Current (AC-21A)		Capacity 3Phase (AC-3)		ราคา (บาท)
			240V	440V	240V	440V	
	SAA16-300011	3P	16A	16A	3KW	5.5KW	1,900.-
	SAA32-300011	3P	32A	32A	4KW	7.5KW	2,100.-
	SAA40-300011	3P	40A	40A	7.5KW	11KW	2,600.-
	SAA63-300011	3P	63A	63A	11KW	18.5KW	3,000.-
	SAA80-300011	3P	80A	80A	15KW	22KW	4,500.-
	SAA100-300011	3P	100A	100A	18.5KW	30KW	4,800.-

* ราคาสินค้าไม่รวมภาษีมูลค่าเพิ่มและราคาอาจเปลี่ยนแปลงได้โดยไม่ต้องแจ้งให้ทราบล่วงหน้า *



SPECIFICATIONS

- Standard : IEC60947-3, GB/T 14048.4
- Rated insulation voltage (Ui) : 660/690V, 1000V
- Rated thermal current (Ith) : 16A, 32A, 40A, 63A, 80A, 100A
- Operating Frequency : 50/60Hz
- Operating efficiency : 30 times / hour
- Electrical life : AC-3 6000 times
- Protective level : IP20
- Ambient temperature : -5°C to +40°C

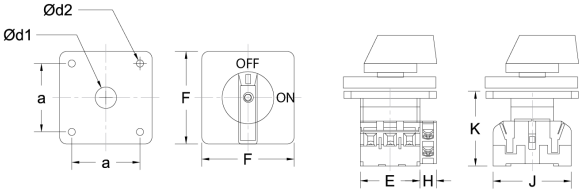

Description	Dimension (mm.)					Installation (mm.)		
	E	F	H	J	K	a	d1	d2
SAA 16/3	42	64	13.5	54	61	48	20	4.2
SAA 32/3	42	64	13.5	54	61	48	20	4.2
SAA 40/3	50	64	16	64	67	48	20	4.2
SAA 63/3	50	64	16	64	67	48	20	4.2
SAA 80/3	70	64	22.5	80	82	48	20	4.2
SAA 100/3	70	64	22.5	80	82	48	20	4.2

Main Switches SAA-Series

Connection Diagram	รุ่น (Model)	Pole	Rated Current (AC-21A)		Capacity 3Phase (AC-3)		Auxiliary		Size (mm.)	ราคา (บาท)
			240V	440V	240V	440V	NO	NC		
	SAA16-310020	3P	16A	16A	3KW	5.5KW	1	1	64x64	900.-
	SAA32-310020	3P	32A	32A	4KW	7.5KW	1	1	64x64	1,100.-
	SAA40-310020	3P	40A	40A	7.5KW	11KW	1	1	64x64	1,300.-
	SAA63-310020	3P	63A	63A	11KW	18.5KW	1	1	64x64	1,700.-
	SAA80-310020	3P	80A	80A	15KW	22KW	1	1	64x64	2,200.-
	SAA100-310020	3P	100A	100A	18.5KW	30KW	1	1	64x64	2,500.-



โทร : 02 550 9555

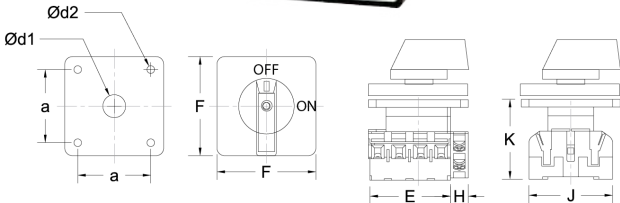

Description	Dimension (mm.)					Installation (mm.)		
	E	F	H	J	K	a	d1	d2
SAA 16/4	55	64	13.5	54	61	48	20	4.2
SAA 32/4	55	64	13.5	54	61	48	20	4.2
SAA 40/4	65	64	16	64	67	48	20	4.2
SAA 63/4	65	64	16	64	67	48	20	4.2
SAA 80/4	91	64	22.5	80	82	48	20	4.2
SAA 100/4	91	64	22.5	80	82	48	20	4.2

Main Switches SAA-Series

Connection Diagram	รุ่น (Model)	Pole	Rated Current (AC-21A)		Capacity 3Phase (AC-3)		Auxiliary		Size (mm.)	ราคา (บาท)
			240V	440V	240V	440V	NO	NC		
	SAA16-410020	4P	16A	16A	3KW	5.5KW	1	1	64x64	1,000.-
	SAA32-410020	4P	32A	32A	4KW	7.5KW	1	1	64x64	1,200.-
	SAA40-410020	4P	40A	40A	7.5KW	11KW	1	1	64x64	1,430.-
	SAA63-410020	4P	63A	63A	11KW	18.5KW	1	1	64x64	1,830.-
	SAA80-410020	4P	80A	80A	15KW	22KW	1	1	64x64	2,350.-
	SAA100-410020	4P	100A	100A	18.5KW	30KW	1	1	64x64	2,650.-

* ราคาสินค้าไม่รวมภาษีมูลค่าเพิ่มและราคาอาจเปลี่ยนแปลงได้โดยไม่ต้องแจ้งให้ทราบล่วงหน้า *

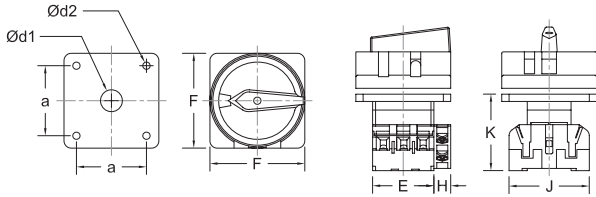

SPECIFICATIONS

- Standard : IEC60947-3, GB/T 14048.4
- Rated insulation voltage (Ui) : 660/690V, 1000V
- Rated thermal current (Ith) : 16A, 32A, 40A, 63A, 80A, 100A
- Operating Frequency : 50/60Hz
- Operating efficiency : 30 times / hour
- Electrical life : AC-3 6000 times
- Protective level : IP20
- Ambient temperature : -5°C to +40°C

Description	Dimension (mm.)					Installation (mm.)		
	E	F	H	J	K	a	d1	d2
SAA 16/3	42	64	13.5	54	61	48	20	4.2
SAA 32/3	42	64	13.5	54	61	48	20	4.2
SAA 40/3	50	64	16	64	67	48	20	4.2
SAA 63/3	50	64	16	64	67	48	20	4.2
SAA 80/3	70	64	22.5	80	82	48	20	4.2
SAA 100/3	70	64	22.5	80	82	48	20	4.2

Safety Switches SAA-Series with Padlock

Connection Diagram	รุ่น (Model)	Pole	Rated Current (AC-21A)		Capacity 3Phase (AC-3)		Auxiliary		Size (mm.)	ราคา (บาท)
			240V	440V	240V	440V	NO	NC		
	SAA16-310010	3P	16A	16A	3KW	5.5KW	1	1	64x64	1,000.-
	SAA32-310010	3P	32A	32A	4KW	7.5KW	1	1	64x64	1,200.-
	SAA40-310010	3P	40A	40A	7.5KW	11KW	1	1	64x64	1,400.-
	SAA63-310010	3P	63A	63A	11KW	18.5KW	1	1	64x64	1,800.-
	SAA80-310010	3P	80A	80A	15KW	22KW	1	1	64x64	2,300.-
	SAA100-310010	3P	100A	100A	18.5KW	30KW	1	1	64x64	2,600.-

โทร : 02 550 9555

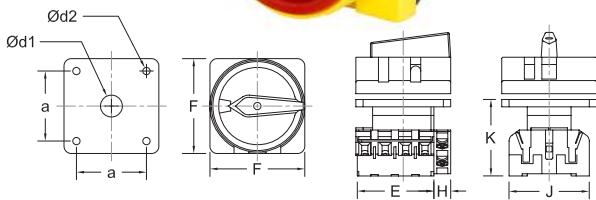

Description	Dimension (mm.)					Installation (mm.)		
	E	F	H	J	K	a	d1	d2
SAA 16/4	55	64	13.5	54	61	48	20	4.2
SAA 32/4	55	64	13.5	54	61	48	20	4.2
SAA 40/4	65	64	16	64	67	48	20	4.2
SAA 63/4	65	64	16	64	67	48	20	4.2
SAA 80/4	91	64	22.5	80	82	48	20	4.2
SAA 100/4	91	64	22.5	80	82	48	20	4.2

Safety Switches SAA-Series with Padlock

Connection Diagram	รุ่น (Model)	Pole	Rated Current (AC-21A)		Capacity 3Phase (AC-3)		Auxiliary		Size (mm.)	ราคา (บาท)
			240V	440V	240V	440V	NO	NC		
	SAA16-410010	4P	16A	16A	3KW	5.5KW	1	1	64x64	1,100.-
	SAA32-410010	4P	32A	32A	4KW	7.5KW	1	1	64x64	1,300.-
	SAA40-410010	4P	40A	40A	7.5KW	11KW	1	1	64x64	1,550.-
	SAA63-410010	4P	63A	63A	11KW	18.5KW	1	1	64x64	1,950.-
	SAA80-410010	4P	80A	80A	15KW	22KW	1	1	64x64	2,500.-
	SAA100-410010	4P	100A	100A	18.5KW	30KW	1	1	64x64	2,800.-

* ราคาสินค้าไม่รวมภาษีมูลค่าเพิ่มและราคาอาจเปลี่ยนแปลงได้โดยไม่ต้องแจ้งให้ทราบล่วงหน้า *



คุณลักษณะ SPECIFICATIONS

- ผลิตจากวัสดุเทอร์โมพลาสติกเกรดอุตสาหกรรม (Made of industrial grade thermoplastic ABS)
- ป้องกันน้ำและฝุ่นได้ตามมาตรฐาน IP20 และผลิตตามมาตรฐาน IP20 IEC 60947-3, GB/T 14048.3
- อุณหภูมิใช้งาน -5°C ถึง +40°C (Able to withstand a temperature range from -5°C to +40°C)
- ทนทานต่อการกัดกร่อนได้ดี (Chemical resistance to aqueous acids, alkalis, salt & sea water. Concentrated phosphoric & hydrochloric acids have little effect on ABS)
- มีช่องสำหรับล็อกกุญแจเพื่อความปลอดภัย (Increase safety with hole for key lock)

Main Switches SAA-Series

Connection Diagram	รุ่น (Model)	Pole	Rated Current (AC-21A)		Capacity 3Phase (AC-3)		Size (mm.)	ราคา (บาท)
			240V	440V	240V	440V		
	SAA 16/300030	3P	16A	16A	3KW	5.5KW	64x64	1,100.-
	SAA 32/300030	3P	32A	32A	4KW	7.5KW	64x64	1,200.-
	SAA 40/300030	3P	40A	40A	7.5KW	11KW	64x64	1,300.-
	SAA 63/300030	3P	63A	63A	11KW	18.5KW	64x64	1,500.-
	SAA 80/300030	3P	80A	80A	15KW	22KW	64x64	1,600.-
	SAA 100/300030	3P	100A	100A	18.5KW	30KW	64x64	2,000.-



SAA 100/300030



SAA 100/300040

บริษัท ซีที อิเล็กทริค ซัพพลาย จำกัด
CT ELECTRIC SUPPLY CO., LTD.

โทร : 02 550 5555

Main Switches SAA-Series

Connection Diagram	รุ่น (Model)	Pole	Rated Current (AC-21A)		Capacity 3Phase (AC-3)		Size (mm.)	ราคา (บาท)
			240V	440V	240V	440V		
	SAA 16/300040	3P	16A	16A	3KW	5.5KW	64x64	1,200.-
	SAA 32/300040	3P	32A	32A	4KW	7.5KW	64x64	1,300.-
	SAA 40/300040	3P	40A	40A	7.5KW	11KW	64x64	1,400.-
	SAA 63/300040	3P	63A	63A	11KW	18.5KW	64x64	1,600.-
	SAA 80/300040	3P	80A	80A	15KW	22KW	64x64	1,700.-
	SAA 100/300040	3P	100A	100A	18.5KW	30KW	64x64	2,100.-

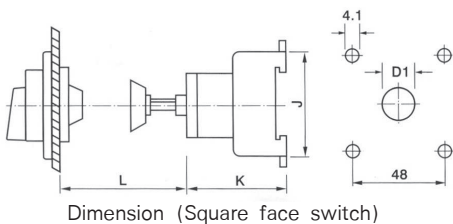

Description	Dimension (mm.)			
	D1	K	Lmin	Lmax
SAA 16, SAA 32	22	50	32	118
SAA 40	22	61	32	118
SAA 63	22	61	32	118
SAA 80	22	68	32	118
SAA100	22	68	32	118

* ราคาสินค้าไม่รวมภาษีมูลค่าเพิ่มและราคาอาจเปลี่ยนแปลงได้โดยไม่ต้องแจ้งให้ทราบล่วงหน้า *



SPECIFICATION

- Conformed to IEC 60947-3, GB14048.3
- Rated current : 125A-1600A
- $U_e = 400/660\text{Vac}$
- $U_i = 800\text{Vac}$
- $U_{imp} = 8\text{kV}$



**โครงสร้างแข็งแรง
เพิ่มความปลอดภัย**

คุณสมบัติหลัก MAIN FEATURES :

- ✓ เหมาะสำหรับสลับแหล่งจ่าย 2 แหล่งจ่ายเช่นจากการไฟฟ้าและพลังงานแสงอาทิตย์ (Suitable for the changeover of two sets of low voltage electric circuit or the changeover of 2 sets of load devices)
- ✓ วิธีสลับแหล่งจ่าย (Modes of operation:):
 - 1) สลับแหล่งจ่ายจากในตัวโดยใช้มือสับด้ามจับที่เครื่องโดยตรง (Direct operation : handle is installed on the switch)
 - 2) สลับแหล่งจ่ายจากภายนอกตู้โดยใช้ก้านต่อเพื่อสับที่หน้าตู้ (Operation outside the board: handle is installed outside the door of power distribution board)
- ✓ ก้านต่อเพื่อสับสำหรับใช้ต่อเพื่อสับที่หน้าตู้เท่านั้น (Extended shaft is used for the operation outside the board)
- ✓ มีให้เลือกทั้ง 3 และ 4 โพล (Available in three poles, and four poles)



3Pole

**อุปกรณ์ที่ใช้ร่วมกัน
หน้า 1-10 (Section 1)**



**อุปกรณ์ที่ใช้ร่วมกัน
หน้า 1-7 (Section 3)**



4Pole

HGL Series

Model รุ่น	Pole	Rated Current	Rated Motor Power	ราคา (บาท)
HGL-125P3	3P	125A	63KW	6,200.-
HGL-160P3	3P	160A	80KW	7,900.-
HGL-200P3	3P	200A	100KW	8,800.-
HGL-250P3	3P	250A	132KW	9,950.-
HGL-315P3	3P	315A	160KW	12,000.-
HGL-400P3	3P	400A	220KW	15,500.-
HGL-500P3	3P	500A	280KW	20,000.-
HGL-630P3	3P	630A	315KW	22,500.-
HGL-1000P3	3P	1000A	560KW	50,000.-
HGL-1250P3	3P	1250A	560KW	55,000.-
HGL-1600P3	3P	1600A	560KW	84,000.-

HGL Series

Model รุ่น	Pole	Rated Current	Rated Motor Power	ราคา (บาท)
HGL-125P4	4P	125A	63KW	6,900.-
HGL-160P4	4P	160A	80KW	8,600.-
HGL-200P4	4P	200A	100KW	9,800.-
HGL-250P4	4P	250A	132KW	11,000.-
HGL-315P4	4P	315A	160KW	13,500.-
HGL-400P4	4P	400A	220KW	18,000.-
HGL-500P4	4P	500A	280KW	25,000.-
HGL-630P4	4P	630A	315KW	29,800.-
HGL-1000P4	4P	1000A	560KW	60,000.-
HGL-1250P4	4P	1250A	560KW	65,000.-
HGL-1600P4	4P	1600A	560KW	98,800.-

* ราคาสินค้าไม่รวมภาษีมูลค่าเพิ่มและราคาอาจเปลี่ยนแปลงได้โดยไม่ต้องแจ้งให้ทราบล่วงหน้า *



HGL Series Manual change over switch Dimension

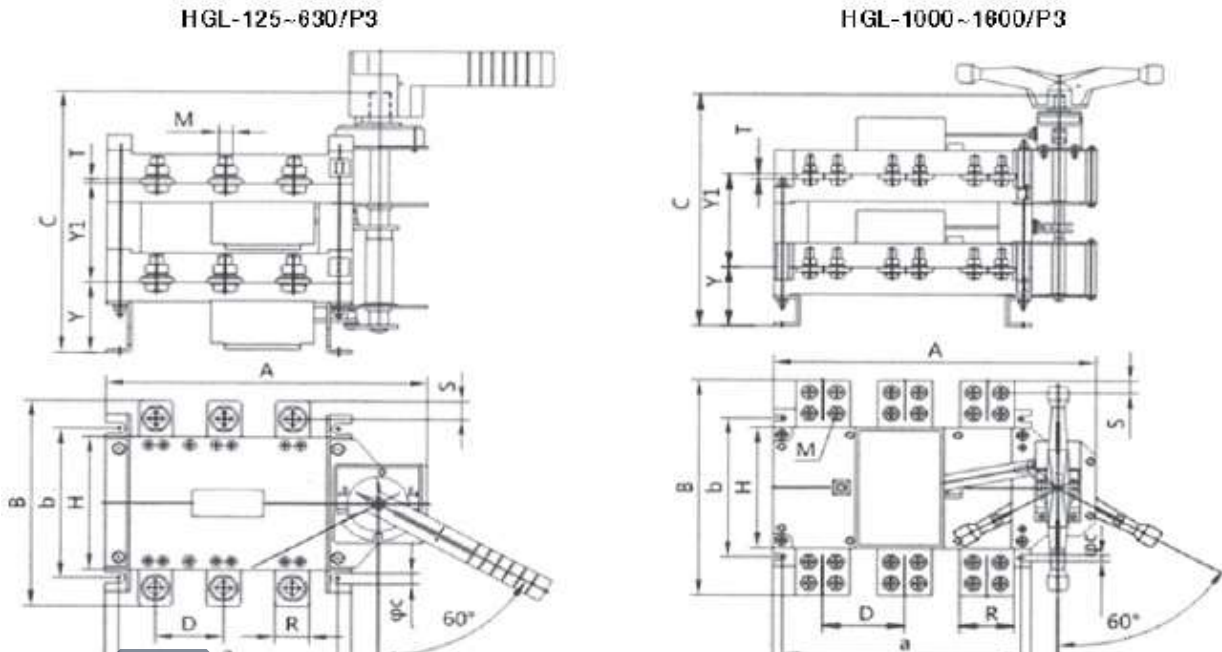

บริษัท ซีที อิเล็กทริค ซัพพลาย จำกัด
CT ELECTRIC SUPPLY CO., LTD.

โทร : 02 550 9555

Product Model		Overall Dimension (mm.)				Installation Dimension (mm.)						Terminal Dimension (mm.)																																																																																																																																																																																																																																																																																						
		A	B	C	D	E	H	a	b	φc	e	f	S	T	Y1	M																																																																																																																																																																																																																																																																																		
HGL-125	/P3	195	135	202	36	140	85	120	95	7	20	20	10	3	74	8																																																																																																																																																																																																																																																																																		
	/P4	225	135	196	36	170	85	150	95	7	20						HGL-160	/P3	195	135	202	36	140	85	120	95	7	20	20	10	3	74	8	/P4	225	135	196	36	170	85	150	95	7	20	HGL-200	/P3	236	165	220	50	176	110	150	115	9	23	25	12	3	86	10	/P4	283	165	220	50	225	110	200	115	9	23	HGL-250	/P3	236	165	220	50	176	110	150	115	9	23	25	12	3	86	10	/P4	283	165	220	50	225	110	200	115	9	23	HGL-315	/P3	300	235	283	65	230	160	210	180	11	35	32	15	5	117	10	/P4	360	235	283	65	290	160	270	180	11	35	HGL-400	/P3	300	235	283	65	230	160	210	180	11	35	32	15	5	117	10	/P4	360	235	283	65	290	160	270	180	11	35	HGL-500	/P3	300	260	283	65	230	160	210	180	11	35	40	20	6	117	12	/P4	360	260	283	65	290	160	270	180	11	35	HGL-630	/P3	300	260	283	65	230	160	210	180	11	35	40	20	6	117	12	/P4	360	260	283	65	290	160	270	180	11	35	HGL-1000	/P3	473	312	348	120	378	200	353	215	11	40	60	20	8	138	12	/P4	593	312	348	120	498	200	473	215	11	40	HGL-1250	/P3	473	356	348	120	378	200	353	215	11	40	80	20	8	138	12	/P4	593	356	348	120	498	200	473	215	11	40	HGL-1600	/P3	475	375	348	120	380	200	360	215	11	40	80	20	8	138	12	/P4	593	375	348	120
HGL-160	/P3	195	135	202	36	140	85	120	95	7	20	20	10	3	74	8																																																																																																																																																																																																																																																																																		
	/P4	225	135	196	36	170	85	150	95	7	20						HGL-200	/P3	236	165	220	50	176	110	150	115	9	23	25	12	3	86	10	/P4	283	165	220	50	225	110	200	115	9	23	HGL-250	/P3	236	165	220	50	176	110	150	115	9	23	25	12	3	86	10	/P4	283	165	220	50	225	110	200	115	9	23	HGL-315	/P3	300	235	283	65	230	160	210	180	11	35	32	15	5	117	10	/P4	360	235	283	65	290	160	270	180	11	35	HGL-400	/P3	300	235	283	65	230	160	210	180	11	35	32	15	5	117	10	/P4	360	235	283	65	290	160	270	180	11	35	HGL-500	/P3	300	260	283	65	230	160	210	180	11	35	40	20	6	117	12	/P4	360	260	283	65	290	160	270	180	11	35	HGL-630	/P3	300	260	283	65	230	160	210	180	11	35	40	20	6	117	12	/P4	360	260	283	65	290	160	270	180	11	35	HGL-1000	/P3	473	312	348	120	378	200	353	215	11	40	60	20	8	138	12	/P4	593	312	348	120	498	200	473	215	11	40	HGL-1250	/P3	473	356	348	120	378	200	353	215	11	40	80	20	8	138	12	/P4	593	356	348	120	498	200	473	215	11	40	HGL-1600	/P3	475	375	348	120	380	200	360	215	11	40	80	20	8	138	12	/P4	593	375	348	120	498	200	473	215	11	40																						
HGL-200	/P3	236	165	220	50	176	110	150	115	9	23	25	12	3	86	10																																																																																																																																																																																																																																																																																		
	/P4	283	165	220	50	225	110	200	115	9	23						HGL-250	/P3	236	165	220	50	176	110	150	115	9	23	25	12	3	86	10	/P4	283	165	220	50	225	110	200	115	9	23	HGL-315	/P3	300	235	283	65	230	160	210	180	11	35	32	15	5	117	10	/P4	360	235	283	65	290	160	270	180	11	35	HGL-400	/P3	300	235	283	65	230	160	210	180	11	35	32	15	5	117	10	/P4	360	235	283	65	290	160	270	180	11	35	HGL-500	/P3	300	260	283	65	230	160	210	180	11	35	40	20	6	117	12	/P4	360	260	283	65	290	160	270	180	11	35	HGL-630	/P3	300	260	283	65	230	160	210	180	11	35	40	20	6	117	12	/P4	360	260	283	65	290	160	270	180	11	35	HGL-1000	/P3	473	312	348	120	378	200	353	215	11	40	60	20	8	138	12	/P4	593	312	348	120	498	200	473	215	11	40	HGL-1250	/P3	473	356	348	120	378	200	353	215	11	40	80	20	8	138	12	/P4	593	356	348	120	498	200	473	215	11	40	HGL-1600	/P3	475	375	348	120	380	200	360	215	11	40	80	20	8	138	12	/P4	593	375	348	120	498	200	473	215	11	40																																																		
HGL-250	/P3	236	165	220	50	176	110	150	115	9	23	25	12	3	86	10																																																																																																																																																																																																																																																																																		
	/P4	283	165	220	50	225	110	200	115	9	23						HGL-315	/P3	300	235	283	65	230	160	210	180	11	35	32	15	5	117	10	/P4	360	235	283	65	290	160	270	180	11	35	HGL-400	/P3	300	235	283	65	230	160	210	180	11	35	32	15	5	117	10	/P4	360	235	283	65	290	160	270	180	11	35	HGL-500	/P3	300	260	283	65	230	160	210	180	11	35	40	20	6	117	12	/P4	360	260	283	65	290	160	270	180	11	35	HGL-630	/P3	300	260	283	65	230	160	210	180	11	35	40	20	6	117	12	/P4	360	260	283	65	290	160	270	180	11	35	HGL-1000	/P3	473	312	348	120	378	200	353	215	11	40	60	20	8	138	12	/P4	593	312	348	120	498	200	473	215	11	40	HGL-1250	/P3	473	356	348	120	378	200	353	215	11	40	80	20	8	138	12	/P4	593	356	348	120	498	200	473	215	11	40	HGL-1600	/P3	475	375	348	120	380	200	360	215	11	40	80	20	8	138	12	/P4	593	375	348	120	498	200	473	215	11	40																																																																														
HGL-315	/P3	300	235	283	65	230	160	210	180	11	35	32	15	5	117	10																																																																																																																																																																																																																																																																																		
	/P4	360	235	283	65	290	160	270	180	11	35						HGL-400	/P3	300	235	283	65	230	160	210	180	11	35	32	15	5	117	10	/P4	360	235	283	65	290	160	270	180	11	35	HGL-500	/P3	300	260	283	65	230	160	210	180	11	35	40	20	6	117	12	/P4	360	260	283	65	290	160	270	180	11	35	HGL-630	/P3	300	260	283	65	230	160	210	180	11	35	40	20	6	117	12	/P4	360	260	283	65	290	160	270	180	11	35	HGL-1000	/P3	473	312	348	120	378	200	353	215	11	40	60	20	8	138	12	/P4	593	312	348	120	498	200	473	215	11	40	HGL-1250	/P3	473	356	348	120	378	200	353	215	11	40	80	20	8	138	12	/P4	593	356	348	120	498	200	473	215	11	40	HGL-1600	/P3	475	375	348	120	380	200	360	215	11	40	80	20	8	138	12	/P4	593	375	348	120	498	200	473	215	11	40																																																																																																										
HGL-400	/P3	300	235	283	65	230	160	210	180	11	35	32	15	5	117	10																																																																																																																																																																																																																																																																																		
	/P4	360	235	283	65	290	160	270	180	11	35						HGL-500	/P3	300	260	283	65	230	160	210	180	11	35	40	20	6	117	12	/P4	360	260	283	65	290	160	270	180	11	35	HGL-630	/P3	300	260	283	65	230	160	210	180	11	35	40	20	6	117	12	/P4	360	260	283	65	290	160	270	180	11	35	HGL-1000	/P3	473	312	348	120	378	200	353	215	11	40	60	20	8	138	12	/P4	593	312	348	120	498	200	473	215	11	40	HGL-1250	/P3	473	356	348	120	378	200	353	215	11	40	80	20	8	138	12	/P4	593	356	348	120	498	200	473	215	11	40	HGL-1600	/P3	475	375	348	120	380	200	360	215	11	40	80	20	8	138	12	/P4	593	375	348	120	498	200	473	215	11	40																																																																																																																																						
HGL-500	/P3	300	260	283	65	230	160	210	180	11	35	40	20	6	117	12																																																																																																																																																																																																																																																																																		
	/P4	360	260	283	65	290	160	270	180	11	35						HGL-630	/P3	300	260	283	65	230	160	210	180	11	35	40	20	6	117	12	/P4	360	260	283	65	290	160	270	180	11	35	HGL-1000	/P3	473	312	348	120	378	200	353	215	11	40	60	20	8	138	12	/P4	593	312	348	120	498	200	473	215	11	40	HGL-1250	/P3	473	356	348	120	378	200	353	215	11	40	80	20	8	138	12	/P4	593	356	348	120	498	200	473	215	11	40	HGL-1600	/P3	475	375	348	120	380	200	360	215	11	40	80	20	8	138	12	/P4	593	375	348	120	498	200	473	215	11	40																																																																																																																																																																		
HGL-630	/P3	300	260	283	65	230	160	210	180	11	35	40	20	6	117	12																																																																																																																																																																																																																																																																																		
	/P4	360	260	283	65	290	160	270	180	11	35						HGL-1000	/P3	473	312	348	120	378	200	353	215	11	40	60	20	8	138	12	/P4	593	312	348	120	498	200	473	215	11	40	HGL-1250	/P3	473	356	348	120	378	200	353	215	11	40	80	20	8	138	12	/P4	593	356	348	120	498	200	473	215	11	40	HGL-1600	/P3	475	375	348	120	380	200	360	215	11	40	80	20	8	138	12	/P4	593	375	348	120	498	200	473	215	11	40																																																																																																																																																																																														
HGL-1000	/P3	473	312	348	120	378	200	353	215	11	40	60	20	8	138	12																																																																																																																																																																																																																																																																																		
	/P4	593	312	348	120	498	200	473	215	11	40						HGL-1250	/P3	473	356	348	120	378	200	353	215	11	40	80	20	8	138	12	/P4	593	356	348	120	498	200	473	215	11	40	HGL-1600	/P3	475	375	348	120	380	200	360	215	11	40	80	20	8	138	12	/P4	593	375	348	120	498	200	473	215	11	40																																																																																																																																																																																																																										
HGL-1250	/P3	473	356	348	120	378	200	353	215	11	40	80	20	8	138	12																																																																																																																																																																																																																																																																																		
	/P4	593	356	348	120	498	200	473	215	11	40						HGL-1600	/P3	475	375	348	120	380	200	360	215	11	40	80	20	8	138	12	/P4	593	375	348	120	498	200	473	215	11	40																																																																																																																																																																																																																																																						
HGL-1600	/P3	475	375	348	120	380	200	360	215	11	40	80	20	8	138	12																																																																																																																																																																																																																																																																																		
	/P4	593	375	348	120	498	200	473	215	11	40																																																																																																																																																																																																																																																																																							

* ราคาสินค้าไม่รวมภาษีมูลค่าเพิ่มและราคาอาจเปลี่ยนแปลงได้โดยไม่ต้องแจ้งให้ทราบล่วงหน้า *

FEATURES

- Ivory color frame
- Utilization category A
- Complying with IEC 60947-2
- Strong Structure

APPLICATION

- Protect damage caused by Overload

NF-Series

รุ่น (Model)	Rated Current (A)	Rated Breaking Capacity (kA) IEC 947-2		ราคา (บาท)	
		230V	380V	2P	3P
NF30-CW	3A, 5A, 10A, 15A, 20A, 30A	2.5	1.5	500.-	600.-
NF63-CW	32A, 40A, 50A, 63A	7.5	5	850.-	980.-
NF63-HW	32A, 40A, 50A, 63A	25	10	1,000.-	1,260.-
NF125-CW	50A, 63A, 80A, 100A, 125A	30	10	1,300.-	1,600.-
NF125-SW	50A, 63A, 80A, 100A, 125A	50	30	1,560.-	2,050.-
NF250-CW	125A, 150A, 160A, 200A, 250A	35	18	-	3,000.-
NF250-SW	125A, 150A, 160A, 200A, 250A	50	30	-	3,500.-
NF400-SW	300A, 350A, 400A	85	50	-	9,800.-
NF630-SW	500A, 600A, 630A	85	50	-	17,000.-



NF30-CW 2P, 3P

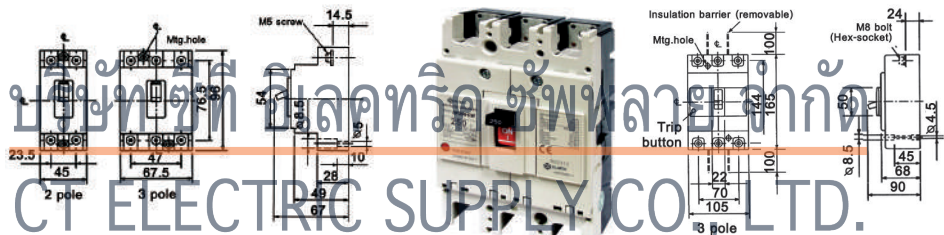

NF250-CW, NF250-SW 3P



NF63-CW, NF63-HW 2P, 3P

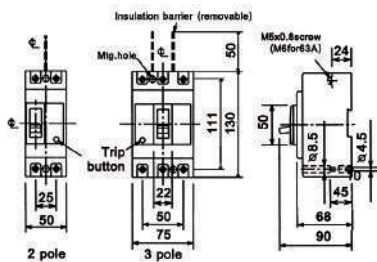

NF400-SW 3P



NF125-CW, NF125-SW 2P, 3P

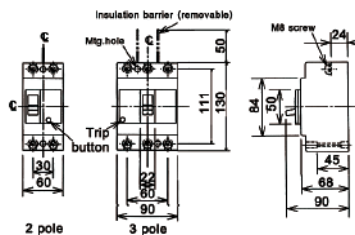

NF630-SW 3P

บริษัท ซีอีอีเล็คทริค จำกัด
CT ELECTRIC SUPPLY CO., LTD.

โทร : 02 550 9555

* ราคาสินค้าไม่รวมภาษีมูลค่าเพิ่มและราคาอาจเปลี่ยนแปลงได้โดยไม่ต้องแจ้งให้ทราบล่วงหน้า *



S-N10



S-N11



S-N12



S-N20



S-N21



S-N25



S-N35



S-N50



S-N65



S-N80



S-N95

S-N Series

รุ่น (Model)	กระแสที่ใช้งาน Rated Operating Current (AC3)		ขนาดมอเตอร์สูงสุด Max. Motor Capacity 3 Phase (AC3)		Thermal Current (AC1)	คอนแทคช่วย Standard Auxiliary Contact		สั่งซื้อระบุ แรงดันคอยล์ (VAC)	ราคา (บาท)
	220-240V	380-440V	220-240V KW(HP)	380-440V KW(HP)		NO	NC		
S-N10	11	9	2.5(3.3)	4(5.5)	20	1NO	-	110VAC 220VAC 380VAC	330.-
S-N11	13	12	3.5(4.5)	5.5(7.5)	20	1NO	-		350.-
S-N12	13	12	3.5(4.5)	5.5(7.5)	20	1NO	1NC		400.-
S-N20	22	22	5.5(7.5)	11(15)	32	1NO	1NC		720.-
S-N21	22	22	5.5(7.5)	11(15)	32	2NO	2NC		750.-
S-N25	30	30	7.5(10)	15(20)	50	2NO	2NC		900.-
S-N35	40	40	11(15)	18.5(25)	60	2NO	2NC		980.-
S-N50	55	55	15(20)	22(30)	80	2NO	2NC		2,060.-
S-N65	65	65	18.5(25)	30(40)	100	2NO	2NC		2,250.-
S-N80	85	85	22(30)	45(60)	135	2NO	2NC		3,200.-
S-N95	105	105	30(40)	55(75)	150	2NO	2NC	3,900.-	



TH-N12



TH-N20



TH-N60(TA)

Overload Relay 3 Elements TH-N Series

รุ่น (Model)	ช่วงปรับ กระแสโอเวอร์โหลด	ราคา (บาท)
TH-N12	1-1.6A, 1.4-2A, 1.7-2.5A, 2-3A, 2.8-4.4A, 4-6A, 5.2-8A, 7-11A, 9-13A.	400.-
TH-N20	4-6A, 5.2-8A, 7-11A, 9-13A, 12-18A, 16-22A, 18-26A, 24-34A, 30-40A,	500.-
TH-N60 (TA)	18-26A, 24-34A, 30-40A, 34-50A, 43-65A,	780.-
	54-80A, 65-93A, 85-105A,	880.-

* ราคาสินค้าไม่รวมภาษีมูลค่าเพิ่มและราคาอาจเปลี่ยนแปลงได้โดยไม่ต้องแจ้งให้ทราบล่วงหน้า *



for SN10 to 12



for SN20 to 21

Coil for Magnetic S-N Series

รุ่น (Model)	ราคา (บาท)
coil for S-N10, S-N11, S-N12	140.-
coil for S-N20, S-N21	160.-
coil for S-N25, S-N35	200.-
coil for S-N50, S-N65	750.-



for SN25 to 35

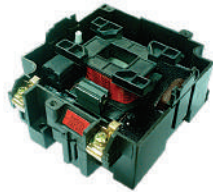

for SN50 to 65



MS-N-10PM



MS-N-20PM

บริษัท ซีที อิเล็กทริค ซัพพลาย จำกัด

CT ELECTRIC SUPPLY CO., LTD.

โทร 02-550-9555

MS-N - PM Series

รุ่น (Model)	กระแสที่ใช้งาน Rated Operating Current (AC3)		ขนาดมอเตอร์สูงสุด Max. Motor Capacity 3 Phase (AC3)KW		คอนแทคช่วย Standard Auxiliary Contact		พิกัดมอเตอร์ 3 เฟส 380VAC		ช่วงปรับกระแส โอเวอร์โหลด (AMP)	ตั้งชื่อระบุ แรงดันคอยล์ (VAC)	ราคา (บาท)
	220-240V	380-440V	220-240V	380-440V	NO	NC	แรงม้า	กิโลวัตต์			
MS-N-10PM	11	9	2.5	4	1NO	-	0.5HP	0.37KW	1-1.6A	220V,380V	1,350.-
MS-N-10PM	11	9	2.5	4	1NO	-	0.75HP	0.55KW	1.4-2A	220V,380V	1,350.-
MS-N-10PM	11	9	2.5	4	1NO	-	1HP	0.75KW	1.7-2.5A	220V,380V	1,350.-
MS-N-10PM	11	9	2.5	4	1NO	-	1.5HP	1.1KW	2-3A	220V,380V	1,350.-
MS-N-10PM	11	9	2.5	4	1NO	-	2HP	1.5KW	2.8-4.4A	220V,380V	1,350.-
MS-N-10PM	11	9	2.5	4	1NO	-	3HP	2.2KW	4-6A	220V,380V	1,350.-
MS-N-10PM	11	9	2.5	4	1NO	-	4HP	3KW	5.2-8A	220V,380V	1,350.-
MS-N-10PM	11	9	2.5	4	1NO	-	5.5HP	4KW	7-11A	220V,380V	1,350.-
MS-N-11PM	13	12	3.5	4	1NO	-	7.5HP	5.5KW	9-13A	220V,380V	1,400.-
MS-N-20PM	22	22	5.5	5.5	1NO	1NC	10HP	7.5KW	12-18A	220V,380V	2,100.-
MS-N-20PM	22	22	5.5	11	1NO	1NC	15HP	11KW	16-22A	220V,380V	2,100.-
MS-N-21PM	22	22	5.5	11	2NO	2NC	10HP	7.5KW	12-18A	220V,380V	2,130.-
MS-N-21PM	22	22	5.5	11	2NO	2NC	15HP	11KW	16-22A	220V,380V	2,130.-

กรุณาสอบถามสำหรับช่วงปรับกระแสโอเวอร์โหลดอื่นๆสำหรับรุ่น MS-N11PM , MS-N20PM , MS-N21PM

* ราคาสินค้าไม่รวมภาษีมูลค่าเพิ่มและราคาอาจเปลี่ยนแปลงได้โดยไม่ต้องแจ้งให้ทราบล่วงหน้า *



SPECIFICATION

- Design according to : IEC/EN 60898-1
- Rated Voltage : AC 230/400V
- Rated Frequency : 50/60 Hz
- Rated breaking capacity : AC 6 kA
- Characteristics : Class C
- Permissible back-up fuse protection : max. 100 A gL (>10 kA)
- Selectivity class : 3
- Tripping Temperature : between -5°C and + 40°C
- Degree of protection : built-in switch IP40
- Electrical life : 4000 operating cycles
- Mechanical life : 10000 operating cycles

FEATURES

- Frame size : 45 mm.
- Socket size : 80 mm.
- Device width : 17.5 mm. per pole(1 mod.)
- Mounting : quick fastening with 2 lock-in positions on DIN rail EN50022

APPLICATION

- Protect damage caused by Overload & Short-Circuit

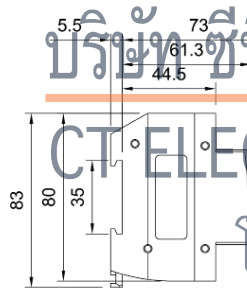
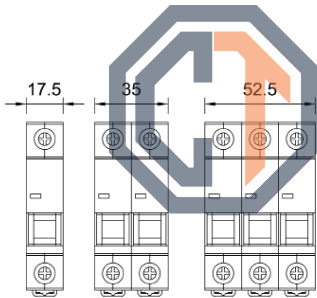

รุ่น (Model)	Rated Current	Rated breaking capacity IEC/EN60898-1	ราคา(บาท)		
			1 Pole	2 Pole	3 Pole
	1A		200.-	500.-	780.-
	2A		200.-	500.-	780.-
	3A		200.-	500.-	780.-
	4A		200.-	500.-	780.-
	6A		130.-	400.-	650.-
	10A		130.-	400.-	650.-
	16A	6KA	130.-	400.-	650.-
	20A		130.-	400.-	650.-
	25A		130.-	400.-	650.-
	32A		130.-	400.-	650.-
	40A		130.-	400.-	650.-
	50A		200.-	500.-	780.-
	63A		200.-	500.-	780.-

บริษัท ซีที อิเล็กทริค ซัพพลาย จำกัด
CT ELECTRIC SUPPLY CO., LTD.
โทร : 02 550 9555

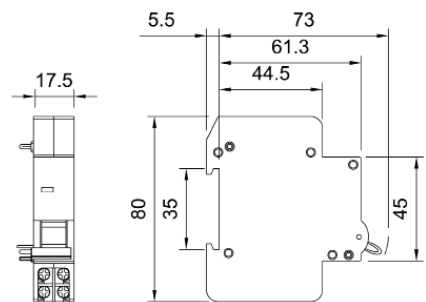
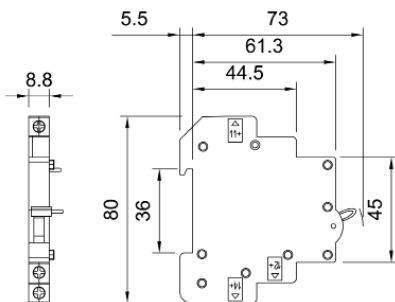

Accessories For MCB

SB6LC-Series

รุ่น (Model)	Description	Voltage	Rated Current	Contact	ราคา (บาท)
AUX6	Auxiliary switches	230/400V	6A / 3A	1NO, 1NC	600.-
SHTA6-230	Shunt trip + Aux	230/400V	6A / 3A	1NO, 1NC	1,000.-
OUVT6-230	Under / Over Voltage	230V	-	-	1,400.-

* ราคาสินค้าไม่รวมภาษีมูลค่าเพิ่มและราคาอาจเปลี่ยนแปลงได้โดยไม่ต้องแจ้งให้ทราบล่วงหน้า *

SPECIFICATION

- Design according to : IEC/EN 60898-1
- Rated Voltage : AC 230/400V
- Rated Frequency : 50/60 Hz
- Rated breaking capacity : AC 10 kA
- Characteristics : Class C
- Permissible back-up fuse protection : max. 100 A gL (>10 kA)
- Selectivity class : 3
- Tripping Temperature : between -5°C and + 40°C
- Degree of protection : built-in switch IP40
- Electrical life : 4000 operating cycles
- Mechanical life : 10000 operating cycles



FEATURES

- Frame size : 45 mm.
- Socket size : 80 mm.
- Device width : 17.5 mm. per pole(1 mod.)
- Mounting : quick fastening with 2 lock-in positions on DIN rail EN50022

APPLICATION

- Protect damage caused by Overload & Short-Circuit

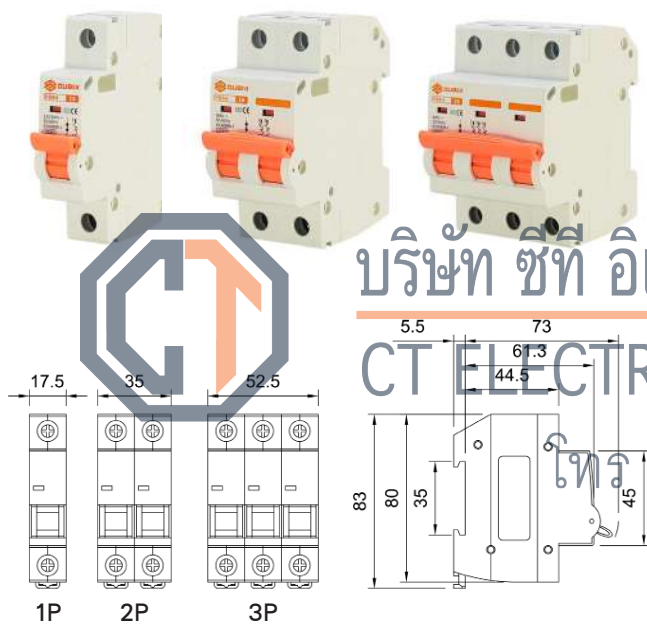

MCB		PB8H-Series			
รุ่น (Model)	Rated Current	Rated breaking capacity IEC/EN60898-1	ราคา(บาท)		
			1 Pole	2 Pole	3 Pole
	1A	10KA	300.-	680.-	1,050.-
	2A		300.-	680.-	1,050.-
	3A		300.-	680.-	1,050.-
	4A		300.-	680.-	1,050.-
	6A		150.-	480.-	800.-
	10A		150.-	480.-	800.-
	16A		150.-	480.-	800.-
	20A		150.-	480.-	800.-
	25A		150.-	480.-	800.-
	32A		150.-	480.-	800.-
	40A	150.-	480.-	800.-	
	50A	300.-	680.-	1,050.-	
	63A	300.-	680.-	1,050.-	

บริษัท ซีที อิเล็กทริก ซัพพลาย จำกัด
CT ELECTRIC SUPPLY CO., LTD
โทร : 02 550 9555

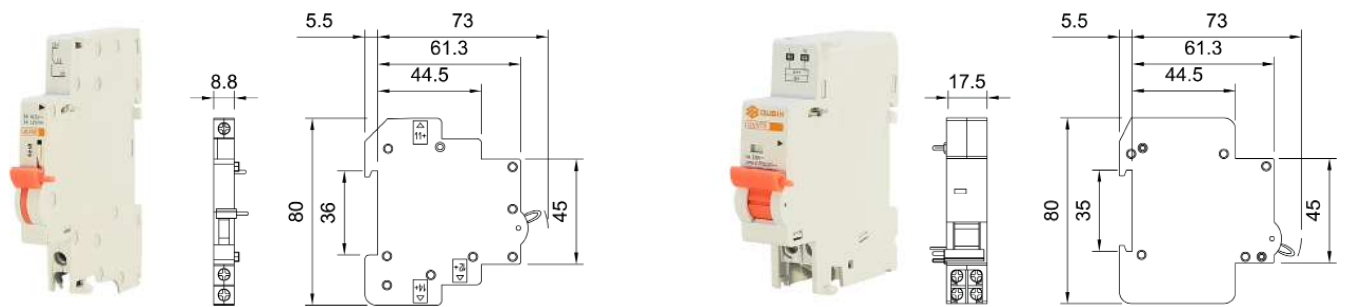

Accessories For MCB					PB8H-Series
รุ่น (Model)	Description	Voltage	Rated Current	Contact	ราคา (บาท)
AUX8	Auxiliary switches	230/400V	6A / 3A	1NO, 1NC	650.-
SHTA8-230	Shunt trip + Aux	230/400V	6A / 3A	1NO, 1NC	1,100.-
OUVT8-230	Under / Over Voltage	230V	-	-	1,500.-

* ราคาสินค้าไม่รวมภาษีมูลค่าเพิ่มและราคาอาจเปลี่ยนแปลงได้โดยไม่ต้องแจ้งให้ทราบล่วงหน้า *



SPECIFICATION

- Design according to : IEC/EN61008-1, IEC/EN61009-1
- No. of poles : 1P+N, 2P, 4P
- Rated current : 6A, 10A, 16A, 20A, 25A, 32A, 40A, 63A
- Rated residual Operating current : 10mA, 30mA
- Rated voltage : 230V / 400VAC
- Rated frequency : 50/60Hz
- Rated conditional Residual short circuit current $I\Delta c$: 6000A
- Tripping duration : instantaneous tripping $\leq 0.1s$
- Residual tripping current range : $0.5I\Delta n - I\Delta n$
- Electro-mechanical endurance : 4000 cycles
- Connection capacity : Rigid conductor 25mm²

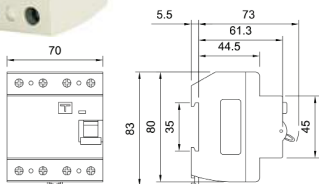
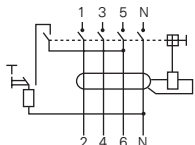
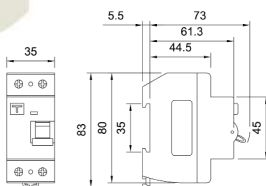
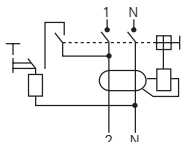
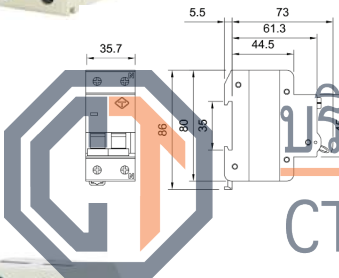
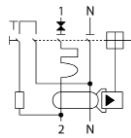

RCBO (อุปกรณ์ป้องกันไฟดูด-ไฟรั่ว-ลัดวงจร) PL8HM-Series

รุ่น (Model)	Pole	Rated breaking capacity IEC/EN61009-1	พิกัดกระแสไฟรั่ว-ไฟดูด	Rated Current	ราคา (บาท)
PL8HM-1NC6-30	1P + N	6KA	30mA	6Amp	1,450.-
PL8HM-1NC10-30			30mA	10Amp	1,450.-
PL8HM-1NC16-30			30mA	16Amp	1,450.-
PL8HM-1NC20-30			30mA	20Amp	1,450.-
PL8HM-1NC25-30			30mA	25Amp	1,450.-
PL8HM-1NC32-30			30mA	32Amp	1,450.-

บริษัท ชัยอเลทริค ซัพพลาย จำกัด
CT ELECTRIC SUPPLY CO., LTD.

RCCB (อุปกรณ์ป้องกันไฟดูด-ไฟรั่ว) SR6HM-Series

รุ่น (Model)	Pole	Rated breaking capacity IEC/EN61008-1	พิกัดกระแสไฟรั่ว-ไฟดูด	Rated Current	ราคา (บาท)
SR6HM-216-10	2 Pole	6KA	10mA	16Amp	1,350.-
SR6HM-216-30			30mA	16Amp	1,200.-
SR6HM-225-30			30mA	25Amp	1,200.-
SR6HM-232-30			30mA	32Amp	1,200.-
SR6HM-240-30			30mA	40Amp	1,200.-
SR6HM-263-30			30mA	63Amp	1,200.-

RCCB (อุปกรณ์ป้องกันไฟดูด-ไฟรั่ว) SR6HM-Series

รุ่น (Model)	Pole	Rated breaking capacity IEC/EN61008-1	พิกัดกระแสไฟรั่ว-ไฟดูด	Rated Current	ราคา (บาท)
SR6HM-416-30	4 Pole	6KA	30mA	16Amp	1,600.-
SR6HM-425-30			30mA	25Amp	1,600.-
SR6HM-432-30			30mA	32Amp	1,600.-
SR6HM-440-30			30mA	40Amp	1,600.-
SR6HM-463-30			30mA	63Amp	1,600.-

* ราคาสินค้าไม่รวมภาษีมูลค่าเพิ่มและราคาอาจเปลี่ยนแปลงได้โดยไม่ต้องแจ้งให้ทราบล่วงหน้า *

SPECIFICATION

- Design according to : IEC/EN61008-1 , IEC/EN61009-1
- No. of poles : 2P, 4P
- Rated current : 16A, 20A, 25A, 32A, 40A, 63A, 80A, 100A
- Rated residual Operating current : 10mA, 30mA
- Rated voltage : 230V / 400VAC
- Rated frequency : 50/60Hz
- Rated conditional Residual short circuit current $I\Delta c$: 10000A
- Tripping duration : instantaneous tripping $\leq 0.1s$
- Residual tripping current range : $0.5I\Delta n \sim I\Delta n$
- Electro-mechanical endurance : 4000 cycles
- Connection capacity : Rigid conductor 25mm²

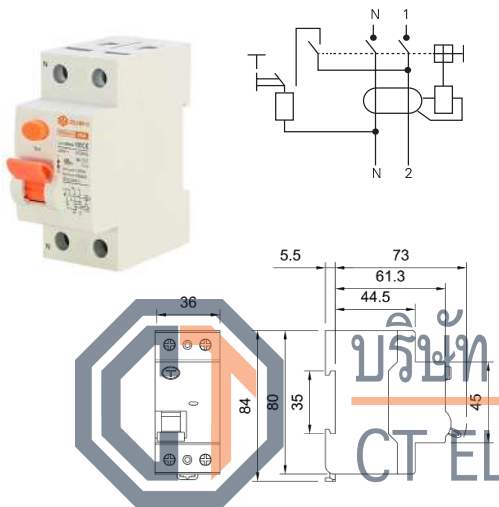

RCCB (อุปกรณ์ป้องกันไฟดูด-ไฟรั่ว)			PR8HM-Series		
รุ่น (Model)	Pole	Rated breaking capacity IEC/EN61008-1	พิกัดกระแสไฟรั่ว-ไฟดูด	Rated Current	ราคา (บาท)
PR8HM-216-10	2 Pole	10KA	10mA	16Amp	1,450.-
PR8HM-216-30			30mA	16Amp	1,450.-
PR8HM-225-30			30mA	25Amp	1,450.-
PR8HM-232-30			30mA	32Amp	1,450.-
PR8HM-240-30			30mA	40Amp	1,450.-
PR8HM-263-30			30mA	63Amp	1,450.-
PR8HM-280-30			30mA	80Amp	2,100.-
PR8HM-2100-30			30mA	100Amp	3,000.-

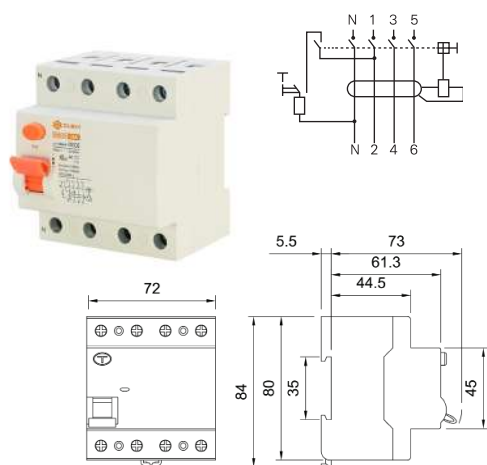

โทร : 02 550 9555

RCCB (อุปกรณ์ป้องกันไฟดูด-ไฟรั่ว)			PR8HM-Series		
รุ่น (Model)	Pole	Rated breaking capacity IEC/EN61008-1	พิกัดกระแสไฟรั่ว-ไฟดูด	Rated Current	ราคา (บาท)
PR8HM-416-30	4 Pole	10KA	30mA	16Amp	2,100.-
PR8HM-425-30			30mA	25Amp	2,100.-
PR8HM-432-30			30mA	32Amp	2,100.-
PR8HM-440-30			30mA	40Amp	2,100.-
PR8HM-463-30			30mA	63Amp	2,100.-
PR8HM-480-30			30mA	80Amp	2,800.-
PR8HM-4100-30			30mA	100Amp	3,700.-



CONSUMER UNIT				
รุ่น (Model)	Modula type	จำนวนช่อง	IP	ราคา (บาท)
SDBSP-2	MCB, RCCB, RCBO	2 ช่อง	IP30	380.-
SDBSP-4		4 ช่อง	IP30	470.-

* ราคาสินค้าไม่รวมภาษีมูลค่าเพิ่มและราคาอาจเปลี่ยนแปลงได้โดยไม่ต้องแจ้งให้ทราบล่วงหน้า *



SA2 Series

22 mm Control boxes.

IP65 lightweight plastic enclosures for installing control switch

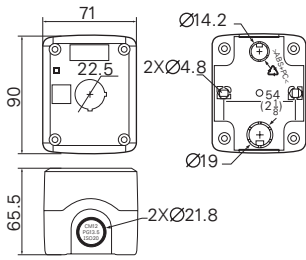

SA2B1...



SA2B4...

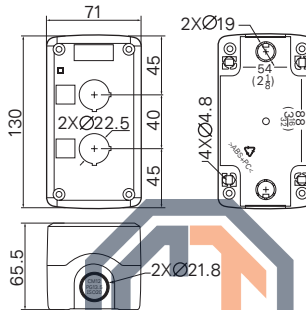
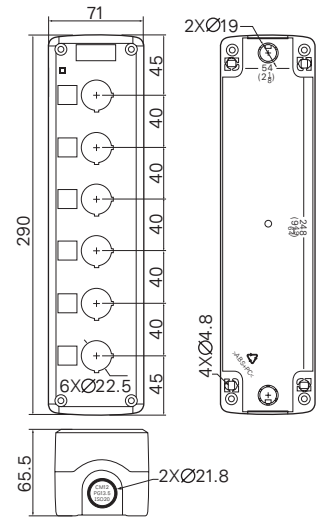
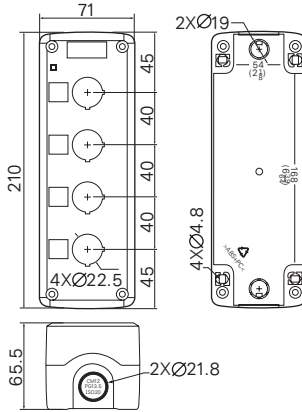

SA2B2...



SA2B5...

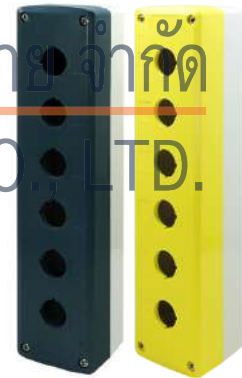
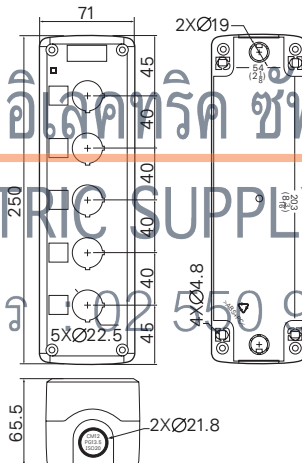

SA2B6...

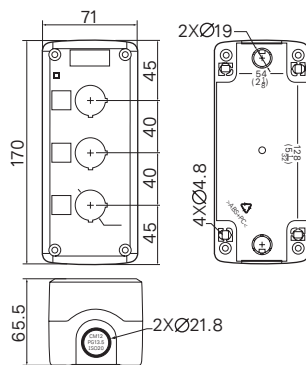

SA2B3...

กล่องคอนโทรล Ø22 mm. (Plastic Control Boxes)

รุ่น (Model)	No. of Mounting Holes	Hole Dimension	Degree of Protection	Cover/Base Color	ราคา (บาท)
SA2B1-G	1	22 mm.	IP65	Dark Gray/ White	170.-
SA2B2-G	2				220.-
SA2B3-G	3				280.-
SA2B4-G	4				420.-
SA2B5-G	5				530.-
SA2B6-G	6				690.-
SA2B1-Y	1	22 mm.	IP65	Yellow/ White	170.-
SA2B2-Y	2				220.-
SA2B3-Y	3				280.-
SA2B4-Y	4				420.-
SA2B5-Y	5				530.-
SA2B6-Y	6				690.-

* ราคาสินค้าไม่รวมภาษีมูลค่าเพิ่มและราคาอาจเปลี่ยนแปลงได้โดยไม่ต้องแจ้งให้ทราบล่วงหน้า *



สว่างกว่าด้วย LED คุณภาพสูง



SPECIFICATION

Power frequency withstand voltage : 2.5kv/1min (effective AC value)
Insulation resistance : $\geq 2M\Omega$
Allowable voltage fluctuation : $\pm 20\%$
Continuous operation life : $\geq 30000h$
Brightness : $\geq 100cd/m^2$
Comparative tracking index : CTI ≥ 100
Ambient temperature : $-5^\circ C - +40^\circ C$
Relative humidity : $\leq 85\%$
Degree of Protection : IP40
Applying frequency : AC 50-60Hz
Standard : IEC947-5-1/EN60947-5-1
Certificated : CE



AD22-22DS...

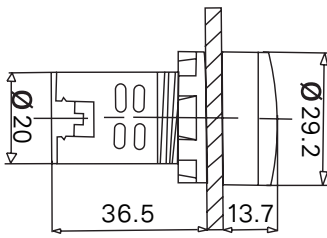

LED Pilot Lamp AD22 - Series

รุ่น (Model)	Rated-Voltage	Current	No.2835 LED Chips	Color	Packing/Box	ราคา/ตัว (บาท)
AD22-22DS-A	12 - 24VDC/AC 110-220VAC	$\leq 20mA$	4 Chips	Amber	10 Pcs.	50.-
AD22-22DS-B			4 Chips	Blue	10 Pcs.	
AD22-22DS-G			4 Chips	Green	10 Pcs.	
AD22-22DS-R			4 Chips	Red	10 Pcs.	
AD22-22DS-W			4 Chips	White	10 Pcs.	

บริษัท ซีที อีเลคทริค ซัพพลาย จำกัด
LED Pilot Lamp Voltmeter AD22 - Series

CT ELECTRIC SUPPLY CO., LTD.



AD22-22VM-S...

รุ่น (Model)	Rated-Voltage	Current	Class	COB LED Chips	Color	Packing/Box	ราคา/ตัว (บาท)
AD22-22VM-S-A	110-500VAC	$\leq 20mA$	2.5	22 Chips	Amber	10 Pcs.	120.-
AD22-22VM-S-B				22 Chips	Blue	10 Pcs.	
AD22-22VM-S-G				22 Chips	Green	10 Pcs.	
AD22-22VM-S-R				22 Chips	Red	10 Pcs.	
AD22-22VM-S-W				22 Chips	White	10 Pcs.	



AD22-22SM-A...



AD22-22SM-R...

Discontinuous sound Buzzer With Flashing Light AD22 - Series

รุ่น (Model)	Rated-Voltage	Current	No.2835 LED Chips	Sound type	Sound level at 10 Cm.	Color	Packing/Box	ราคา/ตัว (บาท)
AD22-22SM-A	12VAC/DC	$\leq 20mA$	4 Chips	Discontinuous sound Buzzer With Flashing light	80 dB	Amber	10 Pcs.	150.-
AD22-22SM-A	24VAC/DC							
AD22-22SM-A	220VAC							
AD22-22SM-R	12VAC/DC	$\leq 20mA$	4 Chips	Discontinuous sound Buzzer With Flashing light	80 dB	Red	10 Pcs.	150.-
AD22-22SM-R	24VAC/DC							
AD22-22SM-R	220VAC							

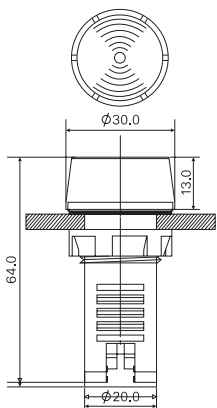

* ราคาสินค้าไม่รวมภาษีมูลค่าเพิ่มและราคาอาจเปลี่ยนแปลงได้โดยไม่ต้องแจ้งให้ทราบล่วงหน้า *



คอนโทรลสวิทช์ Ø22/25 mm. (Control Switches)

รุ่น (Model)	Details	Contact		สีปุ่มกด (Button color)	Pcs/ Box	ราคา (บาท)
		NO	NC			
SA2-FM11		1	1	● ● ● ●	1	180.-
SA2-FM10-G	สวิทช์กดหัวเรียบ กดตั้งกลับ	1	-	●	1	120.-
SA2-FM10-Y		1	-	●	1	120.-
SA2-FM01-R		-	1	●	1	120.-
SA2-MM11-G	สวิทช์กดดอกเห็ด กดตั้งกลับ	1	1	●	1	230.-
SA2-MM11-R		1	1	●	1	230.-
SA2-MK11-R	สวิทช์กดดอกเห็ดล็อก หมุนตั้งกลับ	1	1	●	1	360.-
SA2-MK10-R		1	-	●	1	300.-
SA2-MK01-R		-	1	●	1	300.-
SA2-P211-B	สวิทช์ซีล็คเตอร์ 2 จังหวะ	1	1	●	1	200.-
SA2-P320-B	สวิทช์ซีล็คเตอร์ 3 จังหวะ	2	-	●	1	200.-
SA2-P2R11-B	สวิทช์ซีล็คเตอร์ 2 จังหวะ สปริงรีเทิร์น	1	1	●	1	250.-
SA2-P3R20-B	สวิทช์ซีล็คเตอร์ 3 จังหวะ สปริงรีเทิร์น	2	-	●	1	250.-
SA2-K211	สวิทช์กุญแจ 2 จังหวะ	1	1	-	1	400.-
SA2-K320	สวิทช์กุญแจ 3 จังหวะ	2	-	-	1	400.-

บริษัท ซีที อีเลคทริก ซัพพลาย จำกัด
CT ELECTRIC SUPPLY CO., LTD.

โทร 02 550 9555

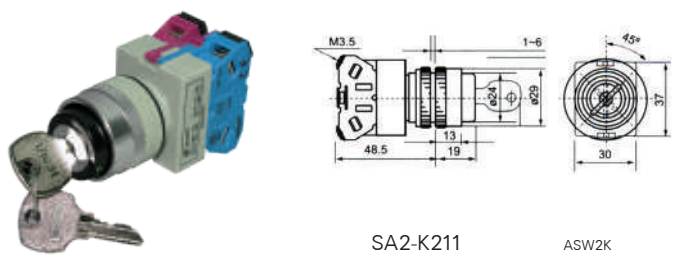
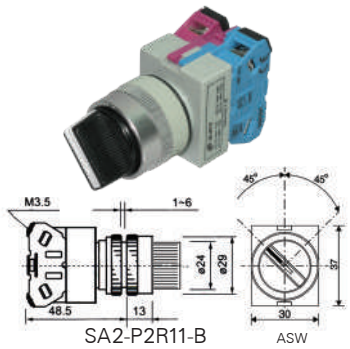
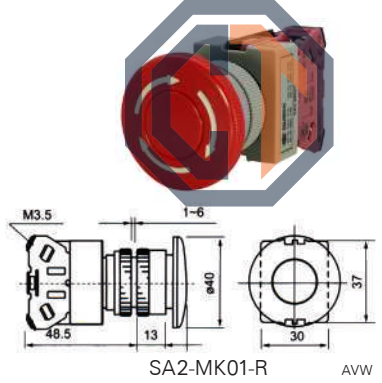
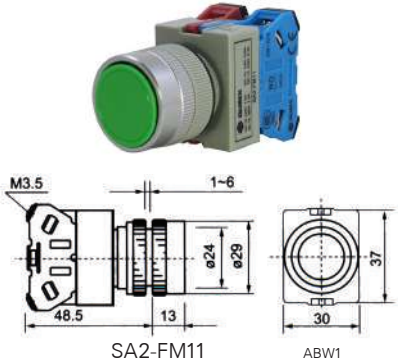

* ราคาสินค้าไม่รวมภาษีมูลค่าเพิ่มและราคาอาจเปลี่ยนแปลงได้โดยไม่ต้องแจ้งให้ทราบล่วงหน้า *

SA2-Series Ø22/25 mm.

รุ่น (Model)	รายละเอียด (Details)	Contact		โวลท์ (Voltage)	สีเลนส์/ปุ่มกด (Lens/Button Color)	ราคา (บาท)
		NO	NC			
SA2-EML11G-2A	สวิทช์กด มีแลมป์ กดเต็งกลับ	1	1	220VAC	เขียว	320.-
SA2-EML11R-2A		1	1	220VAC	แดง	320.-
SA2-EML11Y-2A		1	1	220VAC	เหลือง	320.-
SA2-EML11G-2D	สวิทช์กด มีแลมป์ กดเต็งกลับ	1	1	24VDC	เขียว	320.-
SA2-EML11R-2D		1	1	24VDC	แดง	320.-
SA2-EML11Y-2D		1	1	24VDC	เหลือง	320.-
SA2-MKL11R-2A	สวิทช์กด ดอกเห็ดล็อก มีแลมป์ หมุนเต็งกลับ	1	1	220VAC	แดง	510.-
SA2-MKL10R-2A		1	-	220VAC	แดง	450.-
SA2-MKL01R-2A			1	220VAC	แดง	450.-
SA2-MKL11R-2D	สวิทช์กด ดอกเห็ดล็อก มีแลมป์ หมุนเต็งกลับ	1	1	24VDC	แดง	510.-
SA2-MKL10R-2D		1	-	24VDC	แดง	450.-
SA2-MKL01R-2D			1	24VDC	แดง	450.-
SA2-PL211G-2A	สวิทช์ซีล็คเตอร์ มีแลมป์ 2 จังหวะ	1	1	220VAC	เขียว	400.-
SA2-PL211R-2A		1	1	220VAC	แดง	400.-
SA2-PL211Y-2A		1	1	220VAC	เหลือง	400.-
SA2-PL211G-2D	สวิทช์ซีล็คเตอร์ มีแลมป์ 2 จังหวะ	1	1	24VDC	เขียว	400.-
SA2-PL21R-2D		1	1	24VDC	แดง	400.-
SA2-PL211Y-2D		1	1	24VDC	เหลือง	400.-
SA2-PL320G-2A	สวิทช์ซีล็คเตอร์ มีแลมป์ 3 จังหวะ	2	-	220VAC	เขียว	400.-
SA2-PL320R-2A		2	-	220VAC	แดง	400.-
SA2-PL320Y-2A		2	-	220VAC	เหลือง	400.-
SA2-PL320G-2D	สวิทช์กุญแจ มีแลมป์ 3 จังหวะ	2	-	24VDC	เขียว	400.-
SA2-PL320R-2D		2	-	24VDC	แดง	400.-
SA2-PL320Y-2D		2	-	24VDC	เหลือง	400.-



SA2-EML11G-2D APW

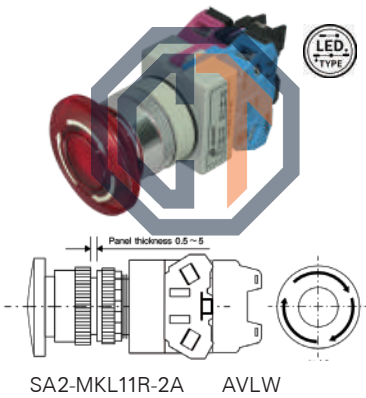

SA2-MKL11R-2A AVLW

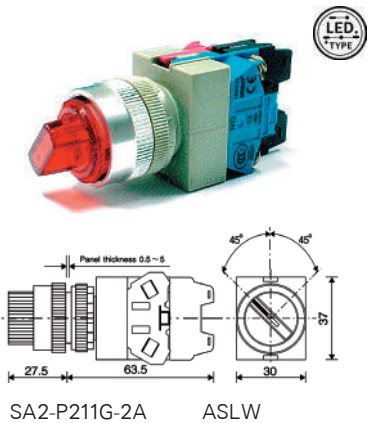

SA2-PL211G-2A ASLW

บริษัท ซีที อีเล็คทริค ซัพพลาย จำกัด
CT ELECTRIC SUPPLY CO., LTD.

โทร 02-550 9555

* ราคาสินค้าไม่รวมภาษีมูลค่าเพิ่มและราคาอาจเปลี่ยนแปลงได้โดยไม่ต้องแจ้งให้ทราบล่วงหน้า *



คอนโทรลสวิทช์ Ø30 mm. (Control Switches)

รุ่น (Mode)	Details	Contact		สีปุ่มกด (Button color)	Pcs/ Box	ราคา (บาท)
		NO	NC			
SA3-FM11		1	1	● ● ● ●	1	210.-
SA3-FM10-G	สวิทช์กดหัวเรียบ	1	-	●	1	150.-
SA3-FM10-Y	กดตั้งกลับ	1	-	●	1	150.-
SA3-FM01-R		-	1	●	1	150.-
SA3-MM11-G	สวิทช์กดดอกเห็ด	1	1	●	1	260.-
SA3-MM11-R	กดตั้งกลับ	1	1	●	1	260.-
SA3-MK11-R		1	1	●	1	390.-
SA3-MK10-R	สวิทช์กดดอกเห็ดล็อก	1	-	●	1	330.-
SA3-MK01-R	หมุนตั้งกลับ	-	1	●	1	330.-
SA3-P211-B	สวิทช์ซีเล็คเตอร์ 2 จังหวะ	1	1	●	1	230.-
SA3-P320-B	สวิทช์ซีเล็คเตอร์ 3 จังหวะ	2	-	●	1	230.-
SA3-P2R11-B	สวิทช์ซีเล็คเตอร์ 2 จังหวะ สปริงรีเทิร์น	1	1	●	1	280.-
SA3-P3R20-B	สวิทช์ซีเล็คเตอร์ 3 จังหวะ สปริงรีเทิร์น	2	-	●	1	280.-
SA3-K211	สวิทช์กุญแจ 2 จังหวะ	1	1	-	1	430.-
SA3-K320	สวิทช์กุญแจ 3 จังหวะ	2	-	-	1	430.-

บริษัท ซีที อีเล็คทริค ซัพพลาย จำกัด
CT ELECTRIC SUPPLY CO., LTD.

โทร 02 550 9555

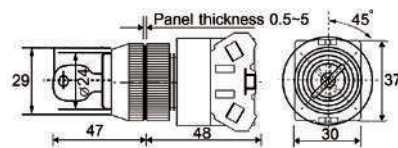
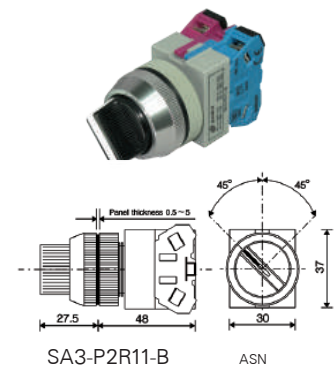
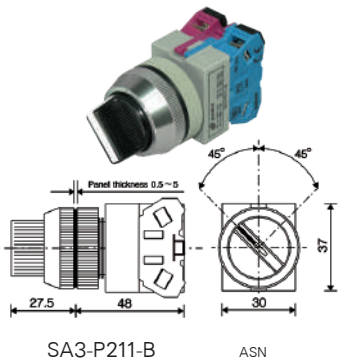
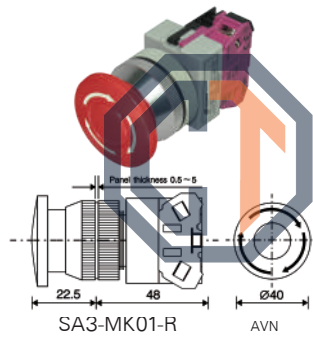
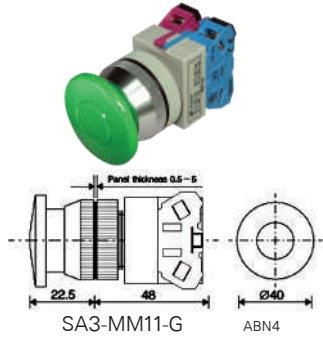
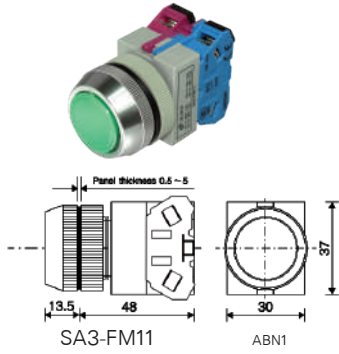

* ราคาสินค้าไม่รวมภาษีมูลค่าเพิ่มและราคาอาจเปลี่ยนแปลงได้โดยไม่ต้องแจ้งให้ทราบล่วงหน้า *

SA3-Series Ø30 mm.

รุ่น (Model)	รายละเอียด (Details)	Contact		โวลท์ (Voltage)	สีเลนส์/ปุ่มกด (Lens/Button Color)	ราคา (บาท)
		NO	NC			
SA3-EML11G-2A	สวิทช์กด มีแสง มีปุ่มกดตั้งกลับ	1	1	220VAC	เขียว	350.-
SA3-EML11R-2A		1	1	220VAC	แดง	350.-
SA3-EML11Y-2A		1	1	220VAC	เหลือง	350.-
SA3-EML11G-2D	สวิทช์กด มีแสง มีปุ่มกดตั้งกลับ	1	1	24VDC	เขียว	350.-
SA3-EML11R-2D		1	1	24VDC	แดง	350.-
SA3-EML11Y-2D		1	1	24VDC	เหลือง	350.-
SA3-MKL11R-2A	สวิทช์กด ดอกเห็ดล็อก มีแสง มีปุ่มตั้งกลับ	1	1	220VAC	แดง	540.-
SA3-MKL10R-2A		1	-	220VAC	แดง	480.-
SA3-MKL01R-2A			1	220VAC	แดง	480.-
SA3-MKL11R-2D	สวิทช์กด ดอกเห็ดล็อก มีแสง มีปุ่มตั้งกลับ	1	1	24VDC	แดง	540.-
SA3-MKL10R-2D		1	-	24VDC	แดง	480.-
SA3-MKL01R-2D			1	24VDC	แดง	480.-
SA3-PL211G-2A	สวิทช์ซีเล็คเตอร์ มีแสง มีปุ่ม 2 จังหวะ	1	1	220VAC	เขียว	430.-
SA3-PL211R-2A		1	1	220VAC	แดง	430.-
SA3-PL211Y-2A		1	1	220VAC	เหลือง	430.-
SA3-PL211G-2D	สวิทช์ซีเล็คเตอร์ มีแสง มีปุ่ม 2 จังหวะ	1	1	24VDC	เขียว	430.-
SA3-PL21R-2D		1	1	24VDC	แดง	430.-
SA3-PL211Y-2D		1	1	24VDC	เหลือง	430.-
SA3-PL320G-2A	สวิทช์ซีเล็คเตอร์ มีแสง มีปุ่ม 3 จังหวะ	2	-	220VAC	เขียว	430.-
SA3-PL320R-2A		2	-	220VAC	แดง	430.-
SA3-PL320Y-2A		2	-	220VAC	เหลือง	430.-
SA3-PL320G-2D	สวิทช์กัญแจ มีแสง มีปุ่ม 3 จังหวะ	2	-	24VDC	เขียว	430.-
SA3-PL320R-2D		2	-	24VDC	แดง	430.-
SA3-PL320Y-2D		2	-	24VDC	เหลือง	430.-

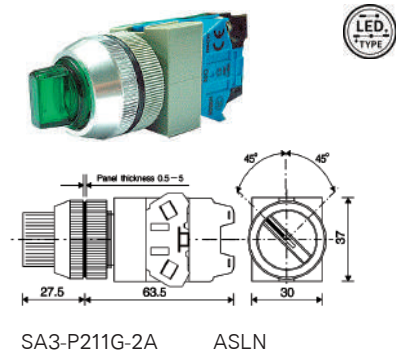
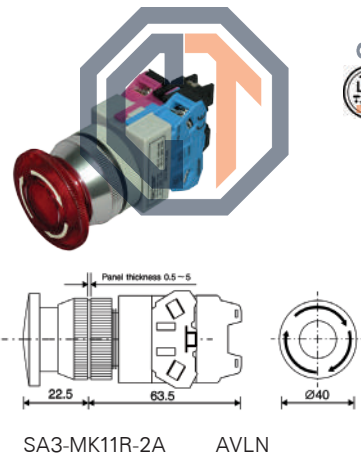
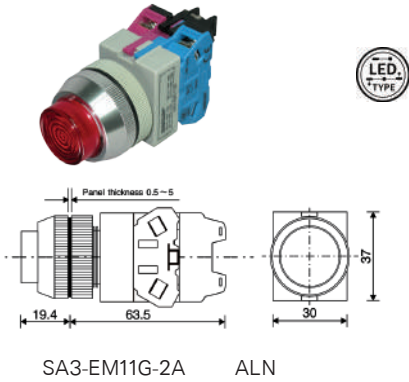

บริษัท ซีที อีเล็คทริค ซัพพลาย จำกัด
CT ELECTRIC SUPPLY CO., LTD.
โทร: 02-550 9555

* ราคาสินค้าไม่รวมภาษีมูลค่าเพิ่มและราคาอาจเปลี่ยนแปลงได้โดยไม่ต้องแจ้งให้ทราบล่วงหน้า *



CBF-251



CBM-251



CBK-251



CSS-251

คอนโทรลสวิทช์ Ø25 mm. (Control Switches)

รุ่น (Model)	Details	Contact	สีปุ่มกด (Button color)	Pcs/Box	ราคา/ตัว (บาท)
CBF-251R/G/BK	สวิทช์กดหัวเรียบ Ø25 mm.	1NO, 1NC	● ● ●	10	70.-
CBF-251R/G/Y			● ● ●	10	70.-
CBM-251R	สวิทช์กดดอกเห็ด Ø25 mm.	1NO, 1NC	● ● ●	10	85.-
CBM-251G			● ● ●	10	85.-
CBK-251R	สวิทช์ดอกเห็ดล็อก Ø25 mm.	1NO, 1NC	● ● ●	10	170.-
CBK-251G			● ● ●	10	170.-
CSS-2512R	สวิทช์ลูกศร Ø25 mm. 2 จังหวะ	1NO, 1NC	● ● ●	10	90.-
CSS-2512G			● ● ●	10	90.-
CSS-2512Y			● ● ●	10	90.-
CSS-2512B			● ● ●	10	90.-
CSS-2513R	สวิทช์ลูกศร Ø25 mm. 3 จังหวะ	1NO, 1NC	● ● ●	10	90.-
CSS-2513G			● ● ●	10	90.-
CSS-2513Y			● ● ●	10	90.-
CSS-2513B			● ● ●	10	90.-



CPNR-252G



CPNR-252R



CPNR-252BL



CPNR-252W



CPNR-252Y

ไฟลีดอตแลมป์ Ø25 mm. (Pilot Lamps)

รุ่น (Model)	Details	Voltage	สีเลนส์ (Lens color)	Pcs/Box	ราคา/ตัว (บาท)
CPNR-252G	ไฟลีดอตแลมป์ แบบต่อตรง Ø25 mm.	220Vac	●	10	55.-
CPNR-252R			●	10	55.-
CPNR-252BL			●	10	55.-
CPNR-252W			○	10	55.-
CPNR-252Y			●	10	55.-

* ราคาสินค้าไม่รวมภาษีมูลค่าเพิ่มและราคาอาจเปลี่ยนแปลงได้โดยไม่ต้องแจ้งให้ทราบล่วงหน้า *



CBF-301



CBM-301



CBK-301



CSS-301

คอนโทรลสวิทช์ Ø30 mm. (Control Switches)

รุ่น (Model)	Details	Contact	สีปุ่มกด (Button color)	Pcs/Box	ราคา/ตัว (บาท)
CBF-301R/G/BK	สวิทช์กดหัวเรียบ Ø30 mm.	1NO, 1NC	● ● ●	10	80.-
CBF-301R/G/Y			● ● ●	10	80.-
CBM-301R	สวิทช์กดดอกเห็ด Ø30 mm.	1NO, 1NC	● ● ●	10	95.-
CBM-301G			● ● ●	10	95.-
CBK-301R	สวิทช์ดอกเห็ดล็อก Ø30 mm.	1NO, 1NC	● ● ●	10	180.-
CBK-301G			● ● ●	10	180.-
CSS-3012R	สวิทช์ลูกศร Ø30 mm. 2 จังหวะ	1NO, 1NC	● ● ●	10	100.-
CSS-3012G			● ● ●	10	100.-
CSS-3012Y			● ● ●	10	100.-
CSS-3012B			● ● ●	10	100.-
CSS-3013R	สวิทช์ลูกศร Ø30 mm. 3 จังหวะ	1NO, 1NC	● ● ●	10	100.-
CSS-3013G			● ● ●	10	100.-
CSS-3013Y			● ● ●	10	100.-
CSS-3013B			● ● ●	10	100.-



CPNR-302G



CPNR-302R



CPNR-302BL



CPNR-302W



CPNR-302Y

ไฟลีดอตแลมป์ Ø30 mm. (Pilot Lamps)

รุ่น (Model)	Details	Voltage	สีเลนส์ (Lens color)	Pcs/Box	ราคา/ตัว (บาท)
CPNR-302G	ไฟลีดอตแลมป์ แบบต่อตรง Ø30 mm.	220Vac	●	10	65.-
CPNR-302R			●	10	65.-
CPNR-302BL			●	10	65.-
CPNR-302W			○	10	65.-
CPNR-302Y			●	10	65.-

* ราคาสินค้าไม่รวมภาษีมูลค่าเพิ่มและราคาอาจเปลี่ยนแปลงได้โดยไม่ต้องแจ้งให้ทราบล่วงหน้า *

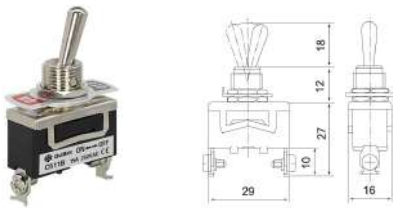

C511B

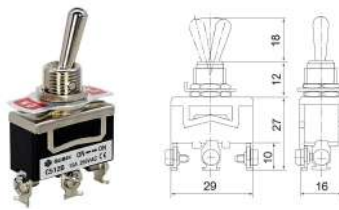

C512B

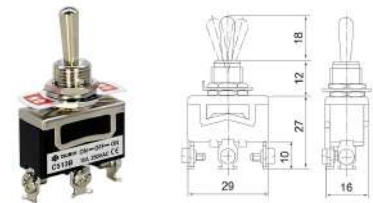

C513B

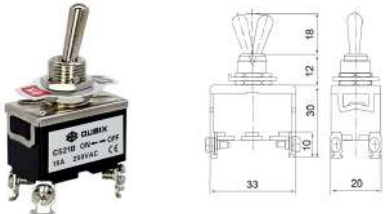

C521B

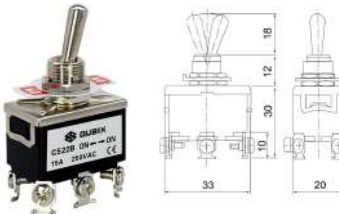

C522B

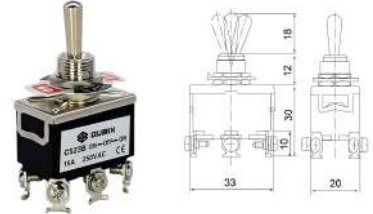

C523B

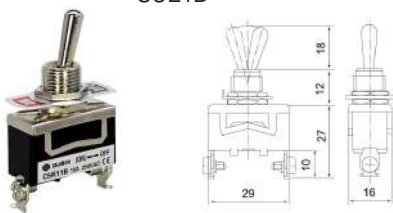

C5R11B

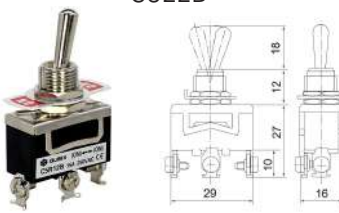

C5R12B

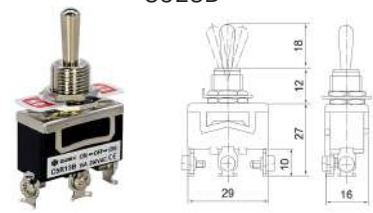

C5R13B

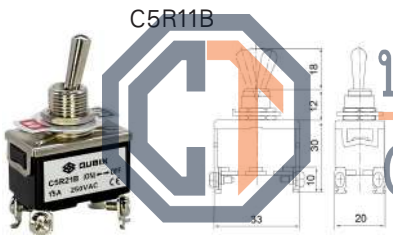

C5R21B

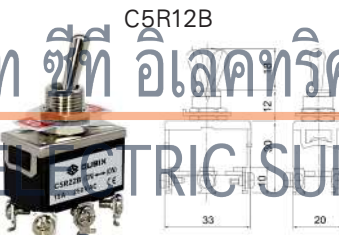

C5R22B

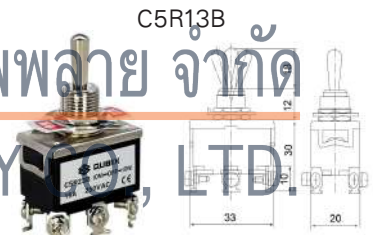

C5R23B

บริษัท ซีที อิเล็กทริก ซัพพลาย จำกัด
CT ELECTRIC SUPPLY, LTD.

โทร 02 550 9555

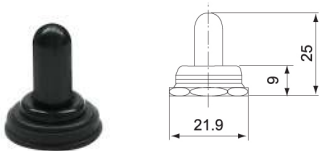

COW (Rainproof cap)

Toggle Switch

รุ่น (Model)	Pole	ขั้ว	Rated Current / Voltage	Type of operation	Contact type	Terminal type	ราคา (บาท)
C511B	1P	2	15A / 250V	ON - OFF	Go - on	Screw type	70.-
C512B	1P	3	15A / 250V	ON - ON			90.-
C513B	1P	3	15A / 250V	ON - OFF - ON			90.-
C521B	2P	4	15A / 250V	ON - OFF			105.-
C522B	2P	6	15A / 250V	ON - ON			115.-
C523B	2P	6	15A / 250V	ON - OFF - ON			115.-
C5R11B	1P	2	15A / 250V	ON - OFF	Spring return		105.-
C5R12B	1P	3	15A / 250V	ON - ON			110.-
C5R13B	1P	3	15A / 250V	ON - OFF - ON			115.-
C5R21B	2P	4	15A / 250V	ON - OFF			130.-
C5R22B	2P	6	15A / 250V	ON - ON			140.-
C5R23B	2P	6	15A / 250V	ON - OFF - ON			140.-
COW	Rainproof cap						45.-

* ราคาสินค้าไม่รวมภาษีมูลค่าเพิ่มและราคาอาจเปลี่ยนแปลงได้โดยไม่ต้องแจ้งให้ทราบล่วงหน้า *

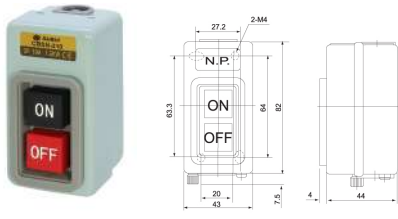

CBSN-310

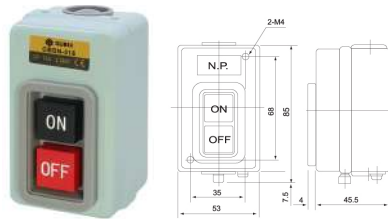

CBSN-315

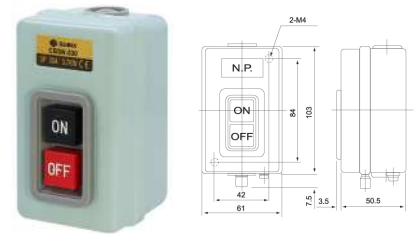

CBSN-330

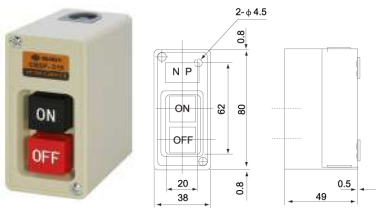

CBSP-315

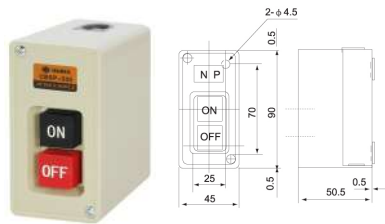

CBSP-330

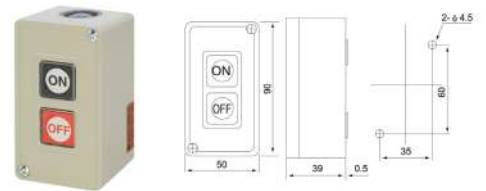

CPB-2



CBSY-315

CBSY-330

บริษัท ซีที อีเลคทริค ซัพพลาย จำกัด
CT ELECTRIC SUPPLY CO., LTD.

โทร : 02 550 9555

CPB-3



CBSS-315

CBSS-330

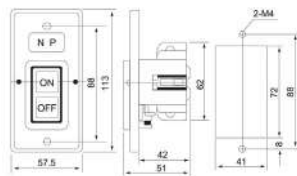

CBS / CPB Series								
รุ่น (Model)	Pole	Rated			Screw terminal	Mounting type	Material	ราคา (บาท)
		Current	Voltage	KW				
CBSN-310	3P	10A	600V	1.5KW	M3.5	Surface mounting	Iron	140.-
CBSN-315	3P	15A	600V	2.2KW	M4			165.-
CBSN-330	3P	30A	600V	3.7KW	M5		230.-	
CBSP-315	3P	15A	600V	2.2KW	M4	Plastic	Iron	160.-
CBSP-330	3P	30A	600V	3.7KW	M4			220.-
CBSY-315	3P	15A	600V	2.2KW	M4	Flush mounting	Iron	240.-
CBSY-330	3P	30A	600V	3.7KW	M4			270.-
CBSS-315	3P	15A	600V	2.2KW	M3.5	Surface mounting	Iron	220.-
CBSS-330	3P	30A	600V	3.7KW	M4			250.-
CPB-2	-	3A	250Vac	-	M4	Surface mounting	Plastic	130.-
CPB-3	-	3A	250Vac	-	M4			160.-

* ราคาสินค้าไม่รวมภาษีมูลค่าเพิ่มและราคาอาจเปลี่ยนแปลงได้โดยไม่ต้องแจ้งให้ทราบล่วงหน้า *



เหมาะกับงานที่มีการควบคุมทิศทาง



CMR-301-1
Stay put
2 ทิศทาง



CMR-301-2
Spring Return
2 ทิศทาง

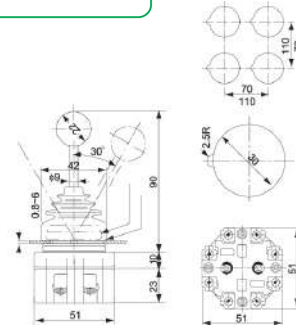

CMR-302-1
Stay put
4 ทิศทาง



CMR-302-2
Spring Return
4 ทิศทาง

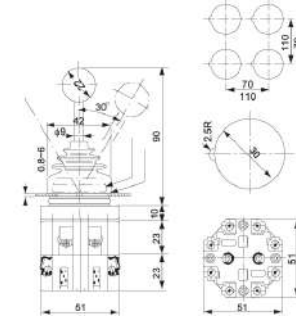

CMRN-301-1
Stay put
2 ทิศทาง



CMRN-301-2
Spring Return
2 ทิศทาง



บริษัท อีเลคทริก ซัพพลาย จำกัด
CT ELECTRIC SUPPLY CO., LTD.

โทร : 02 550 9555



CMRN-302-1
Stay put
4 ทิศทาง



CMRN-302-2
Spring Return
4 ทิศทาง

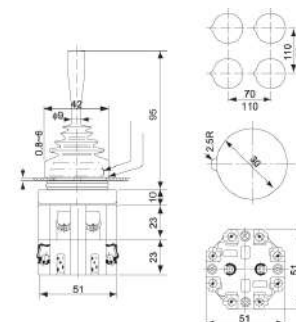

Monolever Switch

รุ่น (Model)	Pole	Rated Current / Voltage	Function type	Direction number	Mounting hole	ราคา (บาท)
CMR-301-1	1P	6A / 220V	Stay put	2 ทิศทาง	30mm.	890.-
CMR-301-2	1P	6A / 220V	Spring return			890.-
CMR-302-1	2P	6A / 220V	Stay put	4 ทิศทาง	30mm.	990.-
CMR-302-2	2P	6A / 220V	Spring return			990.-
CMRN-301-1	1P	6A / 220V	Stay put	2 ทิศทาง	30mm.	1,190.-
CMRN-301-2	1P	6A / 220V	Spring return			1,190.-
CMRN-302-1	2P	6A / 220V	Stay put	4 ทิศทาง	30mm.	1,290.-
CMRN-302-2	2P	6A / 220V	Spring return			1,290.-

* ราคาสินค้าไม่รวมภาษีมูลค่าเพิ่มและราคาอาจเปลี่ยนแปลงได้โดยไม่ต้องแจ้งให้ทราบล่วงหน้า *



CFS-201

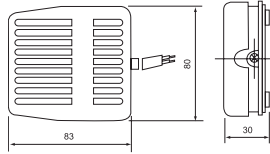

CFS-01

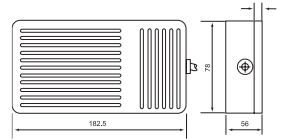

CFS-101 , CFS-102 , CFS-105

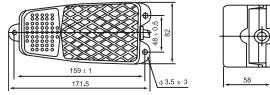

CFS-1

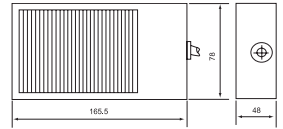

CFS-2

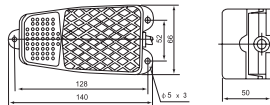

CFS-3 , CFS-3S

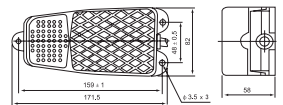

CFS-302

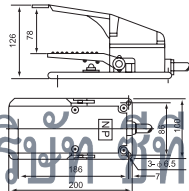

CFS-402

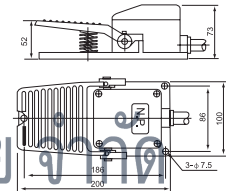

CFS-502

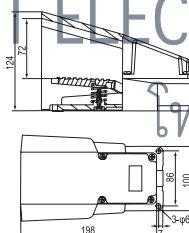

CFS-602

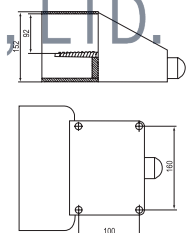

บริษัท อีเลคทริค ซัพพลาย จำกัด

CT ELECTRIC SUPPLY CO., LTD.

โทร : 02 550 9555

CFS Series						
รุ่น (Model)	Type of switch enclosed & contact arrangement	Rated Current / Voltage	Contact Type	Cable Type / Length	Material	ราคา (บาท)
CFS-101	CMV-100D	10A / 250V	1A 1B	0.75mm ² x3C / 1M.	Plastic	450.-
CFS-102	CM-1704	15A / 250V	1A 1B	0.75mm ² x3C / 1M.		580.-
CFS-105	CS-105	6A / 250V	Push ON / OFF	0.75mm ² x2C / 1M.		800.-
CFS-2	CMV-100D	10A / 250V	1A 1B	0.5mm ² x3C / 1M.	Aluminum Cast	450.-
CFS-3	CMV-100D	10A / 250V	1A 1B	0.75mm ² x3C / 1M.		500.-
CFS-3S	CM-1704	15A / 250V	1A 1B	0.75mm ² x3C / 1M.		600.-
CFS-201	CMV-100D	10A / 250V	1A 1B	0.5mm ² x3C / 1M.	Plastic	280.-
CFS-01	CMV-100D	10A / 250V	1A 1B	0.5mm ² x3C / 1M.		320.-
CFS-1	CMV-100D	10A / 250V	1A 1B	0.5mm ² x3C / 1M.	Iron	350.-
CFS-302	CM-1704	15A / 250V	1A 1B	Accessory cable Gland (No cable)	Aluminum Cast	1,250.-
CFS-402	CM-1704	15A / 250V	1A 1B			1,100.-
CFS-502	CM-1704	15A / 250V	1A 1B			2,200.-
CFS-602	Button spring type	15A / 250V	2x1A 1B			3,900.-

* ราคาสินค้าไม่รวมภาษีมูลค่าเพิ่มและราคาอาจเปลี่ยนแปลงได้โดยไม่ต้องแจ้งให้ทราบล่วงหน้า *



UKY-23

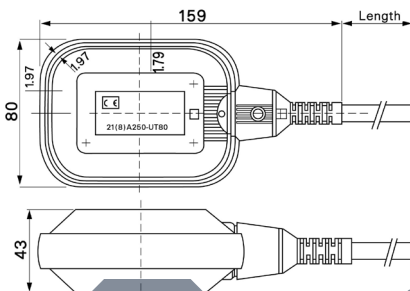

คุณลักษณะ

- ใช้แรงดันไฟฟ้า 220 โวลท์
- พิกัดกระแส 15 แอมป์ (8 แอมป์ สำหรับโหลดมอเตอร์ COS φ =0.8)

ประสิทธิภาพและจุดเด่น

- โครงสร้างไม่ซับซ้อนแต่มีความแข็งแรงทนทาน
ผลิตจากวัสดุพลาสติก POLYPROPYLENE
- มีอายุการใช้งานที่ยาวนาน การบำรุงรักษาและติดตั้งทำได้ง่าย
- การปรับระดับอุปกรณ์ควบคุมระดับน้ำสามารถทำได้ง่ายเพียงไขน็อตตัวเดียว
- สามารถใช้งานได้หลากหลายกว้างขวางเช่น ใช้เปิดปิดระบบน้ำอัตโนมัติภายในถังเก็บน้ำเพื่อเติมน้ำให้ได้ระดับหรือป้องกันน้ำล้น และสามารถป้องกันปั้มน้ำจากปัญหาโอเวอร์โหลดได้
- ประหยัดเวลาและลดจำนวนคนที่ต้องทำหน้าที่เปิดปิดระบบน้ำ

UKY Series

รุ่น (Model)	Rated Current	Cable Length (m.)	ราคา (บาท)
UKY-23	15A	3 m.	450.-
UKY-25	15A	5 m.	650.-

บริษัท ซีที อิเล็กทริค ซัพพลาย จำกัด
 CT ELECTRIC SUPPLY CO., LTD.
 โทร : 02 550 9555

ลักษณะการติดตั้ง (Mounting Of Switch)

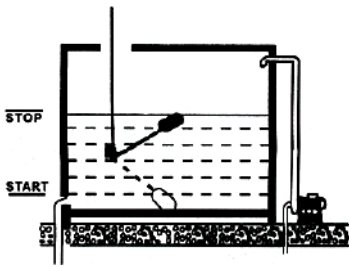

แบบสูบน้ำเข้า
 "ใช้สายสีดำและสีน้ำเงิน"
 สวิตช์จะปิดเมื่อลูกลอยลอยขึ้น
 สวิตช์จะเปิดเมื่อระดับน้ำลดลง

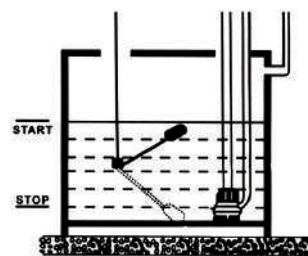

แบบสูบน้ำออก
 "ใช้สายสีน้ำตาลและสีดำ"
 สวิตช์จะปิดเมื่อลูกลอยลดลง
 สวิตช์จะเปิดเมื่อระดับน้ำเพิ่มขึ้น

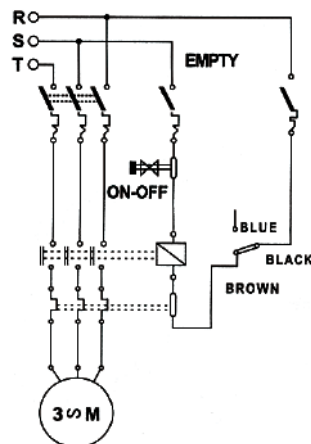
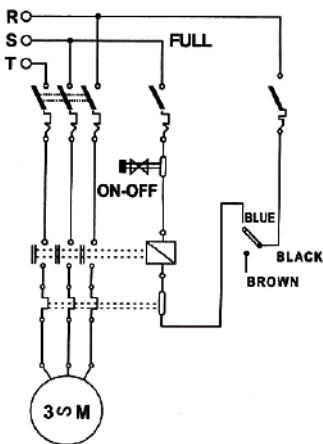

* ราคาสินค้าไม่รวมภาษีมูลค่าเพิ่มและราคาอาจเปลี่ยนแปลงได้โดยไม่ต้องแจ้งให้ทราบล่วงหน้า *



SA-992



SA-2502



SA-3602



SA-4602

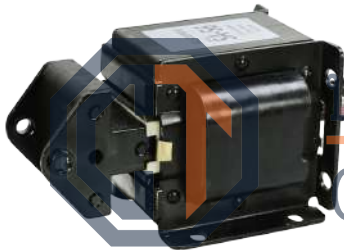

SA-56

SA - Series

รุ่น (Model)	หน้าที่ Duties	โวลท์ Voltage	ระยะชน Rated Stroke	กำลังดึง Rated Pull	ราคา (บาท)
SA-992	Push-Pull	220 V	10 mm.	0.5 Kg.	500.-
SA-1192	Push-Pull	220 V	10 mm.	0.8 Kg.	620.-
SA-2402	Push-Pull	220 V	15 mm.	1.0 Kg.	690.-
SA-2502	Push-Pull	220 V	15 mm.	1.5 Kg.	760.-
SA-2602	Push-Pull	220 V	15 mm.	2.0 Kg.	800.-
SA-3502	Push-Pull	220 V	20 mm.	3.0 Kg.	1,300.-
SA-3602	Push-Pull	220 V	20 mm.	4.0 Kg.	1,400.-
SA-3702	Push-Pull	220 V	20 mm.	5.0 Kg.	1,520.-
SA-4502	Push-Pull	220 V	30 mm.	6.0 Kg.	3,600.-
SA-4602	Push-Pull	220 V	30 mm.	8.0 Kg.	4,100.-
SA-52	Push-Pull	220 V	40 mm.	10.0 Kg.	5,500.-
SA-56	Push-Pull	220 V	40 mm.	12.0 Kg.	7,200.-

บริษัท ซีที อีเลคทริค ซัพพลาย จำกัด
CT ELECTRIC SUPPLY CO., LTD.

โทร : 02-550 9555

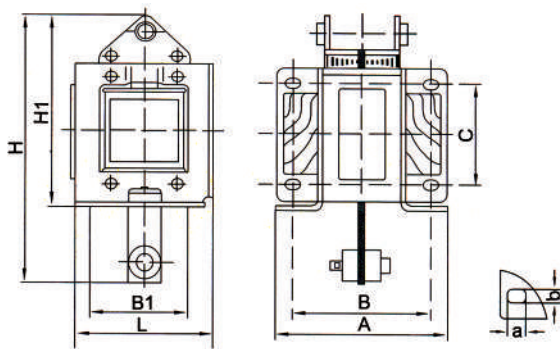

Model	H	H1	L	A	B1±0.5	B1±1.5	C±0.5	axb
SA-992	85	62	38	34.5	28	24	33	5x4
SA-1192	85	62	38	43	28	32	33	5x4
SA-2402	93	69	47	45.5	34	35	35	6x4
SA-2502	93	69	47	51	34	41	35	6x4
SA-2602	93	69	47	55.5	34	45	35	6x4
SA-3502	130	96	61.5	71	46	55.5	46	9x7
SA-3602	130	96	61.5	76	46	61	46	9x7
SA-3702	130	96	61.5	82	46	67	46	9x7
SA-4502	171	123	84	102	64	83	64	10x7
SA-4602	171	123	84	112	64	93	64	10x7
SA-52	201	146.5	100	87	60	70	60	11x9
SA-56	201	146.5	100	97.5	60	80	60	11x9

* ราคาสินค้าไม่รวมภาษีมูลค่าเพิ่มและราคาอาจเปลี่ยนแปลงได้โดยไม่ต้องแจ้งให้ทราบล่วงหน้า *

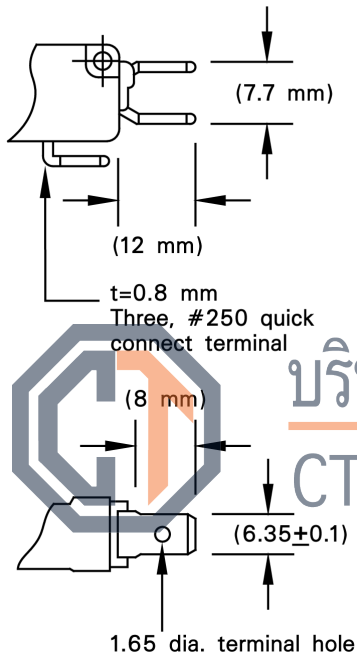

MAIN FEATURES :

- ✓ High switch on and off capacity (16A)
- ✓ Economy model

Characteristics			
Item	CMV 10	CMV16	CMV 21
Operation speed	0.1mm~1m/s (Button type)		
Operation frequency	Mechanical : 240 operations/min Electrical : 20 operations/min		
Insulation resistance	100MΩ above(at 500Vdc)		
Contact resistance	15MΩmax.(initial value)		
Withstand voltage	Non-continuous terminals	1,000Vac, 50/60Hz for 1 min.	
	Current-carrying and non-current-carrying metal parts. Between terminal and earthing	1,500Vac, 50/60Hz for 1min.	2,000Vac, 50/60Hz for 1 min.
Vibration	Misoperation	10 to 55Hz, 1.5mm pairs swing	
Shock resistant	Durable	1,000m/s ² (100G)	
	Misoperation	200m/s ² (100G)	300m/s ² (100G)
Life	Mechanical	10,000,000 operations min.	
	Electrical	300,000 operations min.	100,000 operations min.
Temperature	-10°C ~ +65°C		
Humidity	85%RH		

บริษัท ซีที อีเล็คทริก ซัพพลาย จำกัด
CT ELECTRIC SUPPLY CO., LTD.
โทร : 02 550 9555

Model Designations

CMV 16 0 C
1 2 3

Item	Code	Description
1. Rated Current	10	10A
	16	16A
	21	21A
2. Head and driving rod	01	Pin Plunger
	11	Hinge Lever
	21	Short Hinge Lever
	31	Hinge Roller Lever
	41	Short Hinge Roller Lever
	51	Long Hinge Lever
61	Simulated Lever	
3. Terminal specifications	C	#250 terminal
	D	#187 terminal

Ratings

Spec.	Rated voltage	Noninductive Load (A)				Inductive Load (A)				Inrush Current (A)	
		Resistance Load		Lamp Load		Inductive Load		Motor Load			
		NC	NO	NC	NO	NC	NO	NC	NO	NC	NO
10A	250Vac	10		1.5		6		2		24 max.	
	8Vdc	10		3		6		3			
	30Vdc	6		3		6		3			
	125Vdc	0.3		0.1		0.6		0.1			
	250Vdc	0.3		0.05		0.3		0.05			
16A	250Vac	16		2		10		3		40 max.	
	8Vdc	16		4		10		6			
	30Vdc	10		4		10		4			
	125Vdc	0.6		0.1		0.6		0.1			
	250Vdc	0.3		0.05		0.3		0.05			
21A	250Vac	21		3		12		4		50 max.	
	8Vdc	21		5		12		7			
	30Vdc	14		5		12		5			
	125Vdc	0.6		0.1		0.6		0.1			
	250Vdc	0.3		0.05		0.3		0.05			

* ราคาสินค้าไม่รวมภาษีมูลค่าเพิ่มและราคาอาจเปลี่ยนแปลงได้โดยไม่ต้องแจ้งให้ทราบล่วงหน้า *

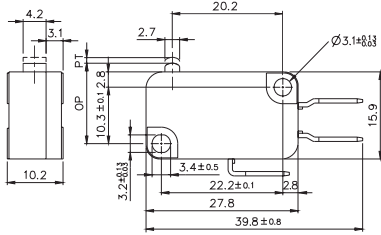

CMV16001C

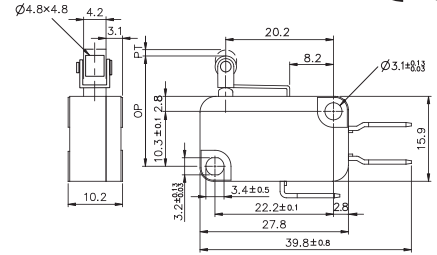

CMV16041C

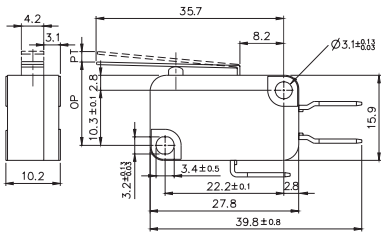

CMV16011C

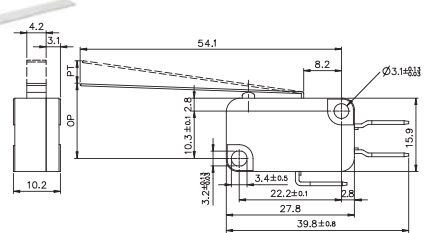

CMV16051C

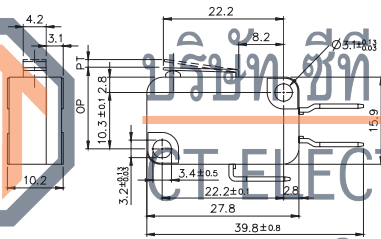
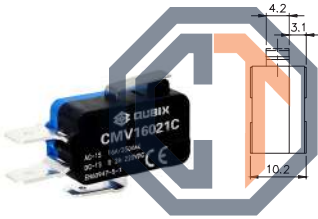

CMV16021C

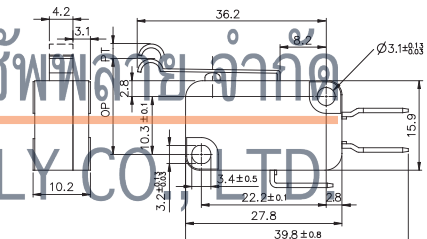

โทร : 02-550 9555

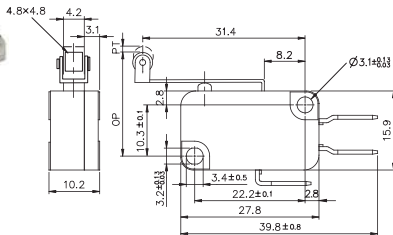

CMV16031C

CMV16 Series

รุ่น (Model)	ลักษณะ หน้าสัมผัสทำงาน	Rated Current / Voltage	Contact Type	Terminal Type	ราคา (บาท)
CMV16001C	Pin Plunger	16A / 250V	SPDT 1NO, 1NC	NEMA TYPE #250 TAB 6.3 mm	45.-
CMV16011C	Hinge Lever	16A / 250V	SPDT 1NO, 1NC		45.-
CMV16021C	Short Hinge Lever	16A / 250V	SPDT 1NO, 1NC		45.-
CMV16031C	Hinge Roller Lever	16A / 250V	SPDT 1NO, 1NC		58.-
CMV16041C	Short Hinge Roller Lever	16A / 250V	SPDT 1NO, 1NC		58.-
CMV16051C	Long Hinge Lever	16A / 250V	SPDT 1NO, 1NC		55.-
CMV16061C	Simulated Roller Lever	16A / 250V	SPDT 1NO, 1NC		55.-

* ราคาสินค้าไม่รวมภาษีมูลค่าเพิ่มและราคาอาจเปลี่ยนแปลงได้โดยไม่ต้องแจ้งให้ทราบล่วงหน้า *



MAIN FEATURES :

- ✓ Various Actuators, action position is adjustable (such as CM1701)
- ✓ High switch on and off capacity(15A)
- ✓ High accuracy
- ✓ Wide range of operation speed

Characteristics

Operating speed	0.01mm to 1m/sec
Operating frequency	Mechanical : 240 operations/min. Electrical : 20 operations/min.
Contact resistance	15M Ω max. (initial value)
Insulation resistance	100M Ω min. (at 500 VDC)
Dielectric strength	1000 VAC, 50/60 Hz for 1 minute between terminals of the same polarity 1500 VAC, 50/60 HZ for 1 minute between current-carrying and noncurrent-carrying metal parts 1500 VAC, 50/60 HZ for 1 minute between each terminal and ground
Vibration	Malfunction durability : 10 to 55Hz; 1.5mm double amplitude
Shock resistant	Mechanical durability : Approx. 1,000m/sec ² (approx. 100G's) Malfunction durability : Approx. 300m/sec ² (approx. 30G's)
Ambient temperature	General purpose type : -25°C to +80°C (With no icing) Sealed type : -15°C to +80°C (With no icing)
Humidity	General purpose type : 85%RH max. Sealed type : 95%RH max.
Service life	Mechanically : 20,000,000 operations min. (at rate OT value) Electrically : 500,000 operations min.

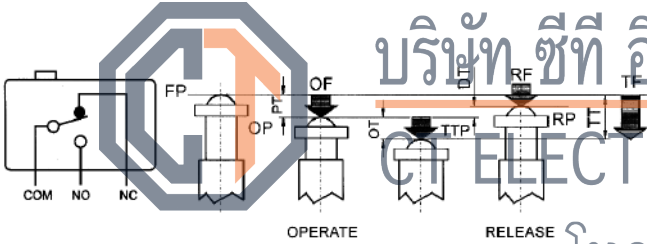
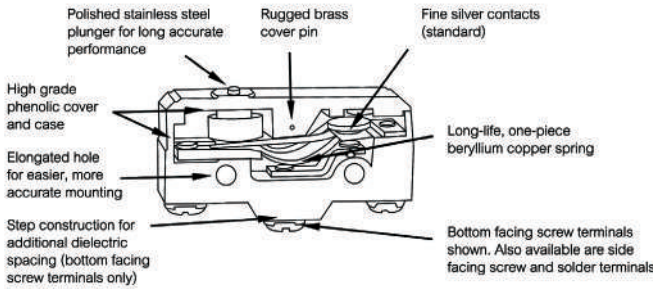

- OF : Operating Force
- RF : Releasing Force
- TF : Total Force
- FP : Free Position
- OP : Operating Position
- RP : Releasing Position

- TTP : Total Travel Position
- PT : Pretravel
- OT : Overtravel
- DT : Travel Differential
- TT : Total Travel

โทร : 02-550-9555

Rated Voltage	Non-inductive load				Inductive load			
	Resistive Load		Lamp Load		Inductive load		Motor Load	
	NC	NO	NC	NO	NC	NO	NC	NO
125 VAC	15	15	3	1.5	15	15	5	2.5
250 VAC	15	15	2.5	1.25	15	15	3	1.5
8 VDC	15	15	3	1.5	15	15	5	2.5
30 VDC	6	6	3	1.5	5	5	5	2.5
125 VDC	0.4	0.4	0.4	0.4	0.05	0.05	0.05	0.05

Types of actuator	Model	OF max (g.)	RF min (g.)	PT max (mm.)	OT min (mm.)	MD max (mm.)	FP max (mm.)	OP (mm.)
Pin plunger	CM1300	350	114	0.4	0.13	0.05	-	15.9 ± 0.4
Overtravel plunger	CM1305	350	114	0.4	1.6	0.05	-	28.2 ± 0.5
Compact Overtravel plunger	CM1306	350	114	0.4	1.6	0.05	-	21.5 ± 0.5
Panel mount plunger	CM1307	350	114	0.4	5.5	0.05	-	21.8 ± 0.8
Panel mount roller plunger	CM1308	350	114	0.4	3.58	0.05	-	33.4 ± 1.2
Panel mount cross roller plunger	CM1309	350	114	0.4	3.58	0.05	-	33.4 ± 1.2
Rigid lever	CM1701	70	14	10	5.6	1.27	28.2	19 ± 0.8
Rigid roller lever	CM1703	160	22	7.1	4	1.02	36.5	30.2 ± 0.8
Rigid short roller lever	CM1704	160	42	2.7	2.4	0.5	32.5	30.2 ± 0.4
Low force wire hinge lever	CM1705	10	3	20	5.6	3	-	19 ± 0.8
Hinge roller lever	CM1743	160	42	2.7	2.4	0.5	43.6	43.1 ± 0.8

* ราคาสินค้าไม่รวมภาษีมูลค่าเพิ่มและราคาอาจเปลี่ยนแปลงได้โดยไม่ต้องแจ้งให้ทราบล่วงหน้า *

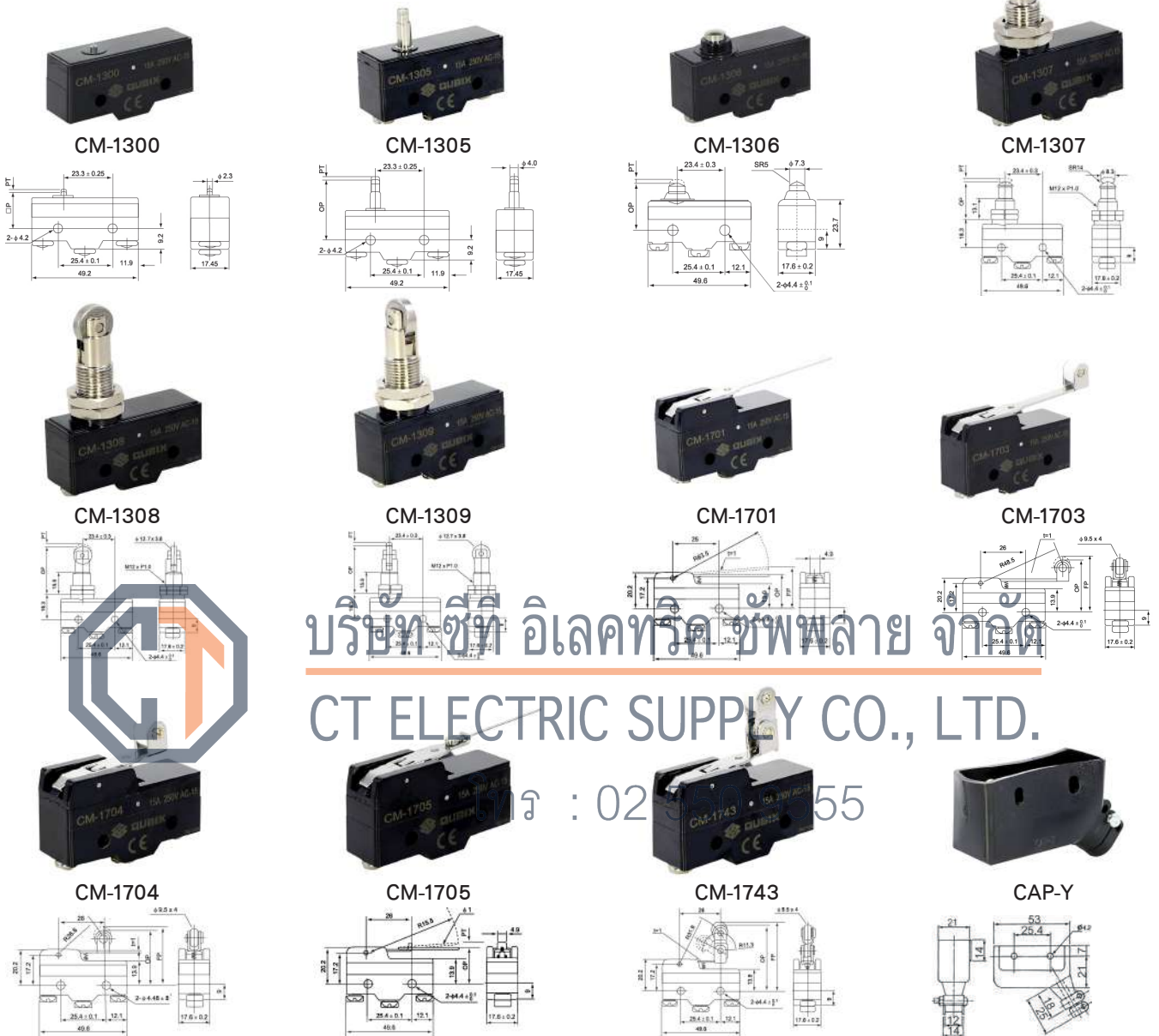

บริษัท ซีที อิเล็กทริก ซัพพลาย จำกัด
CT ELECTRIC SUPPLY CO., LTD.

โทร : 02-555-1555

CM-1300 Series / CM-1700 Series

รุ่น (Model)	ลักษณะ หน้าสัมผัสทำงาน	Rated Current / Voltage	Contact Type	Terminal Type	Packing Pcs/Box	ราคา/ตัว (บาท)
CM-1300	Pin Plunger	15A / 250V	SPDT 1NO, 1NC	SCREW TYPE	20	110.-
CM-1305	Overtravel Plunger	15A / 250V	SPDT 1NO, 1NC		20	120.-
CM-1306	Compaq Overtravel Plunger	15A / 250V	SPDT 1NO, 1NC		20	120.-
CM-1307	Panel Mount Plunger	15A / 250V	SPDT 1NO, 1NC		20	145.-
CM-1308	Panel Mount Roller Plunger	15A / 250V	SPDT 1NO, 1NC		20	185.-
CM-1309	Panel Mount Cross Roller Plunger	15A / 250V	SPDT 1NO, 1NC		20	195.-
CM-1701	Rigid Lever	15A / 250V	SPDT 1NO, 1NC		20	135.-
CM-1703	Rigid Roller Lever	15A / 250V	SPDT 1NO, 1NC		20	145.-
CM-1704	Rigid Short Roller Lever	15A / 250V	SPDT 1NO, 1NC		20	145.-
CM-1705	Low Force Wire Hinge Lever	15A / 250V	SPDT 1NO, 1NC		20	170.-
CM-1743	Hinge Roller Lever	15A / 250V	SPDT 1NO, 1NC		20	165.-
CAP-Y	Terminal Cover	-	-		20	35.-

* ราคาสินค้าไม่รวมภาษีมูลค่าเพิ่มและราคาอาจเปลี่ยนแปลงได้โดยไม่ต้องแจ้งให้ทราบล่วงหน้า *

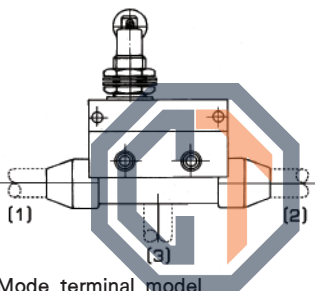
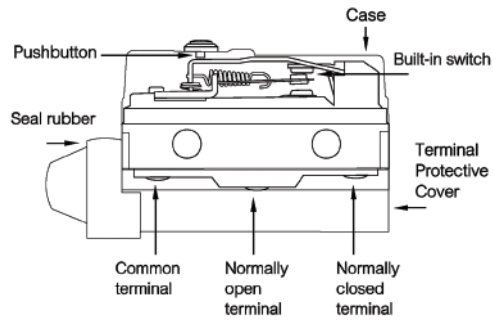

Moded terminal model

The moded terminal model is available with right-hand, left-hand and underside leads and is recommended for use where the switch is exposed to dust, oil moisture.

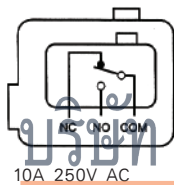

10A 250V AC

0.5A 125V DC

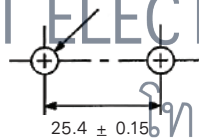

Mounting holes

Two 4.3 dia. mounting holes or M4 screw holes

Note:

1. Inductive loads have a power factor of 0.4min.(AC) and a time constant of 7 ms max.(DC).
2. Lamp load has an inrush current of 10 times the steady-state current.
3. Motor load has an inrush current of 6 times the steady-state current

MAIN FEATURES :

- ✓ Various Actuators, operation position is adjustable (such as CZ-7121)
- ✓ Outer shell covered with intensive plastic, water-proof and oil-proof. The mechanical strength is better than CM type of micro switch

Characteristics

Operating speed	0.5mm to 50cm/sec
Operating frequency	Mechanical : 120 operations/min. Electrical : 30 operations/min.
Contact resistance	15M Ω max. (initial value)
Insulation resistance	100M Ω above (at 500 VDC)
Dielectric strength	1000 VAC, 50/60 Hz for 1 minute between terminals of the same polarity 1500 VAC, 50/60 Hz for 1 minute between current-carrying and noncurrent-carrying metal parts 1500 VAC, 50/60 Hz for 1 minute between each terminal and ground
Vibration	Action:10 to 55Hz,1.5mm pairs swing
Shock resistant	Mechanical durability : Approx. 1,000m/sec ² (approx. 100G's) Malfunction durability : Approx. 300m/sec ² (approx. 30G's)
Ambient temperature	Operating: -10°C to +80°C
Humidity	<95%RH
Service life	Mechanical : 10,000,000 operations above (under rated, QT) Electrical : 500,000 operations above
Degree of protection	IP40

บริษัท ซีที อิเล็กทริค ซัพพลาย จำกัด
CT ELECTRIC SUPPLY CO., LTD.
โทร : 02 550 9555

Rated Voltage	Non-inductive load				Inductive load			
	Resistive Load		Lamp Load		Inductive load		Motor Load	
	NC	NO	NC	NO	NC	NO	NC	NO
125 VAC	10	10	3	1.5	10	10	5	2.5
250 VAC	10	10	2.5	1.25	10	10	3	1.5
8 VDC	10	10	3	1.5	6	6	5	2.5
30 VDC	6	6	3	1.5	5	5	5	2.5
125 VDC	0.5	0.5	0.4	0.4	0.05	0.05	0.05	0.05

Types of actuator	Model	OF max (g.)	RF min (g.)	PT max (mm.)	OT min (mm.)	MD max (mm.)	FP max (mm.)	OP (mm.)
Short push plunger	CZ-7100	600	100	2.0	0.8	0.8	-	30.5 ± 0.8
Push plunger	CZ-7110	600	100	2.0	5.0	0.8	-	44 ± 1.2
Hinge lever	CZ-7120	150	40	13.5	4.0	3.2	35	25 ± 1
Roller lever	CZ-7121	180	50	11	3.0	2.4	-	40 ± 1
One-way roller lever	CZ-7124	200	60	11	3.0	2.4	-	50 ± 1.2
Hinge short lever	CZ-7140	220	60	8.5	2.5	2.0	32	25 ± 1
Short roller lever	CZ-7141	240	80	6.5	2.0	1.5	46	40 ± 1
One-way short roller lever	CZ-7144	280	100	6.5	2.0	1.5	56	50 ± 1.2
Flexible rod	CZ-7166	120	-	250	11	-	-	-
Panel mount push plunger	CZ-7310	600	100	2.0	6.0	0.8	-	21.8 ± 1.2
Panel mount roller plunger	CZ-7311	600	100	2.0	6.0	0.8	-	33.3 ± 1.2
Panel mount cross roller plunger	CZ-7312	600	100	2.0	6.0	0.8	-	33.3 ± 1.2

* ราคาสินค้าไม่รวมภาษีมูลค่าเพิ่มและราคาอาจเปลี่ยนแปลงได้โดยไม่ต้องแจ้งให้ทราบล่วงหน้า *

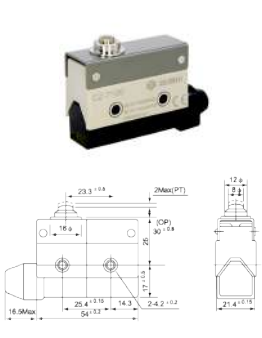

CZ-7100

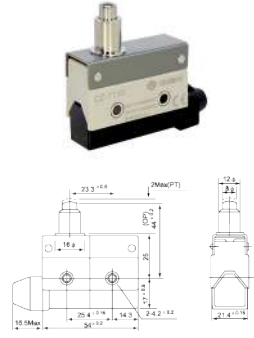

CZ-7110

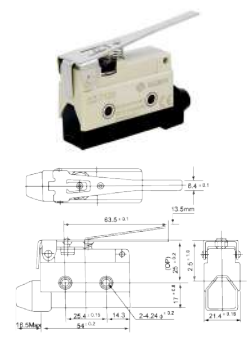

CZ-7120

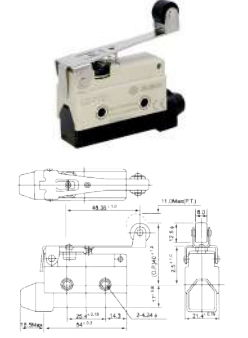

CZ-7121

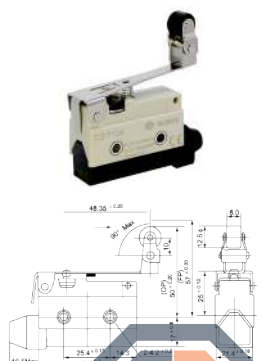

CZ-7124

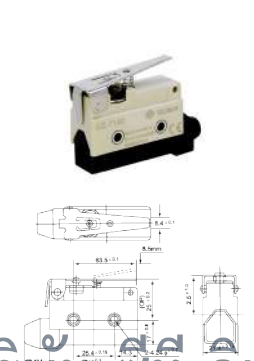

CZ-7140

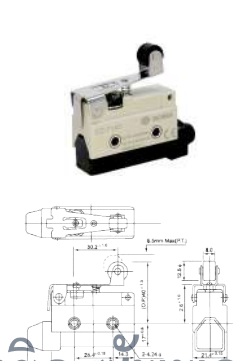

CZ-7141

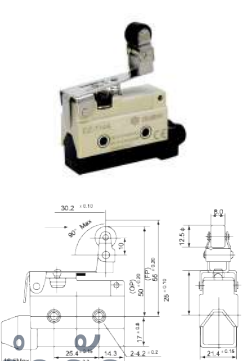

CZ-7144



CZ-7166

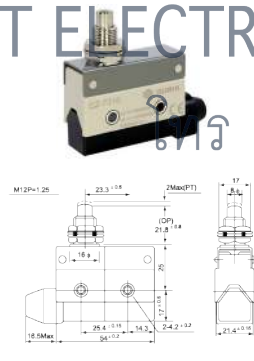

CZ-7310

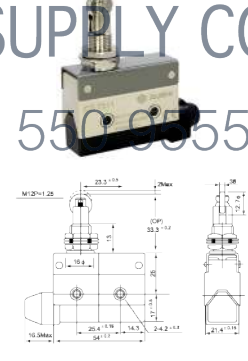

CZ-7311

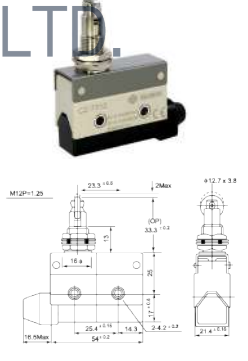

CZ-7312

บริษัท ซีที อเลคทริค ซัพพลาย จำกัด
CT ELECTRIC SUPPLY CO., LTD.
โทร : 02 550 9555

CZ-7000 Series

รุ่น (Model)	ลักษณะ หน้าสัมผัสทำงาน	Rated Current / Voltage	Contact Type	Terminal Type	Packing Pcs/Box	ราคา/ตัว (บาท)
CZ-7100	Short Push Plunger	10A / 250V	DPDT 1NO, 1NC	SCREW TYPE	10	240.-
CZ-7110	Push Plunger	10A / 250V	DPDT 1NO, 1NC		10	235.-
CZ-7120	Hinge Lever	10A / 250V	DPDT 1NO, 1NC		10	220.-
CZ-7121	Roller Plunger	10A / 250V	DPDT 1NO, 1NC		10	230.-
CZ-7124	One-way Roller Lever	10A / 250V	DPDT 1NO, 1NC		10	250.-
CZ-7140	Hinge Short Lever	10A / 250V	DPDT 1NO, 1NC		10	220.-
CZ-7141	Short Roller Lever	10A / 250V	DPDT 1NO, 1NC		10	230.-
CZ-7144	One-way Short Roller Lever	10A / 250V	DPDT 1NO, 1NC		10	250.-
CZ-7166	Flexible rod	10A / 250V	DPDT 1NO, 1NC		10	320.-
CZ-7310	Panel mount push plunger	10A / 250V	DPDT 1NO, 1NC		10	275.-
CZ-7311	Panel mount roller plunger	10A / 250V	DPDT 1NO, 1NC		10	280.-
CZ-7312	Panel mount cross roller plunger	10A / 250V	DPDT 1NO, 1NC		10	280.-

* ราคาสินค้าไม่รวมภาษีมูลค่าเพิ่มและราคาอาจเปลี่ยนแปลงได้โดยไม่ต้องแจ้งให้ทราบล่วงหน้า *

กลไกแข็งแรง ยืดอายุการใช้งาน

IP65
ระดับมอดกัน



MAIN FEATURES :

- ✓ Double circuit type of limit switch
- ✓ Highly rigid construction, consists of intensive plastic and aluminum cast (Head and cover snugly fit in box)
- ✓ Small volume, water-proof and oil-proof construction
- ✓ Built-in basic switch with double spring mechanism, longer mechanical life
- ✓ Smooth operation with greater OT
- ✓ Easy-to-wire circuit opening design
- ✓ Wide variety of actuators, easy to use

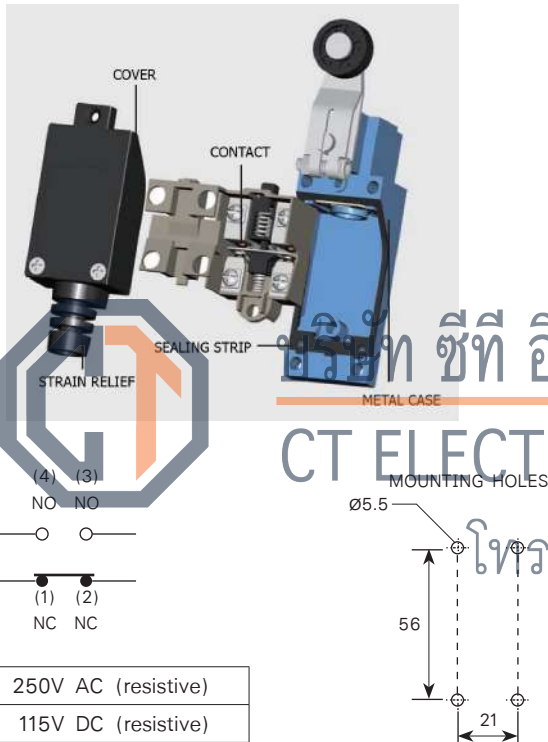

5A	250V AC (resistive)
0.4A	115V DC (resistive)

Note:

1. Inductive loads have a power factor of 0.4min.(AC) and a time constant of 7 ms max.(DC).
2. Lamp load has an inrush current of 10 times the steady-state current.
3. Motor load has an inrush current of 6 times the steady-state current

Operating speed	0.5mm to 50cm/sec
Operating frequency	Mechanical : 120 operations/min. Electrical : 30 operations/min.
Contact resistance	25M Ω max. (initial value)
Insulation resistance	100M Ω min. (below 500 VDC)
Dielectric strength	1000VAC, 50/60 Hz for 1 minute between terminals of the same polarity
	1500VAC, 50/60 Hz for 1 minute between current-carrying and noncurrent-carrying metal parts
Vibration	1500VAC, 50/60 Hz for 1 minute between each terminal and ground
	10 to 55Hz, 1.5mm double amplitude
Shock resistant	Mechanical durability : Approx. 1,000m/sec ² (approx. 100G's)
	Malfunction durability : Approx. 300m/sec ² (approx. 30G's)
Ambient temperature	Operating: -5°C to +65°C
Humidity	<95%RH
Service life	Mechanical : 10,000,000 operations above
	Electrical : 500,000 operations above
Degree of protection	IP65

Rated Voltage	Non-inductive load				Inductive load			
	Resistive Load		Lamp Load		Inductive load		Motor Load	
	NC	NO	NC	NO	NC	NO	NC	NO
125 VAC	5	5	1.5	0.7	3	3	2	1
250 VAC	5	5	1	0.5	3	3	1.5	0.8
8 VDC	5	5	3	3	5	4	3	3
30 VDC	5	5	3	3	4	4	3	3
125 VDC	0.4	0.4	-	-	-	-	-	-

Types of actuator	Model	OF max (g.)	RF min (g.)	PT max (mm.)	OT min (mm.)	MD max (mm.)	OP (mm.)
Roller Lever	CZ-8104	750	100	20°	50°	12°	-
Adjustable Rod Lever	CZ-8107	750	100	20°	50°	12°	-
Adjustable Roller Lever	CZ-8108	750	100	20°	50°	12°	-
Top Plunger	CZ-8111	900	150	1.5	4	1	26 ± 0.8
Roller Plunger	CZ-8112	900	150	1.5	4	1	37 ± 0.8
Cross Roller Plugner	CZ-8122	900	150	1.5	4	1	37 ± 0.8
Coil Spring With Plastic End	CZ-8166	150	-	30	-	-	-
Coil Spring	CZ-8167	150	-	30	-	-	-
Metal Stick	CZ-8168	150	-	30	-	-	-
Spring wire	CZ-8169	150	-	30	-	-	-

* ราคาสินค้าไม่รวมภาษีมูลค่าเพิ่มและราคาอาจเปลี่ยนแปลงได้โดยไม่ต้องแจ้งให้ทราบล่วงหน้า *

IP65
ระดับมรน้ำกัน

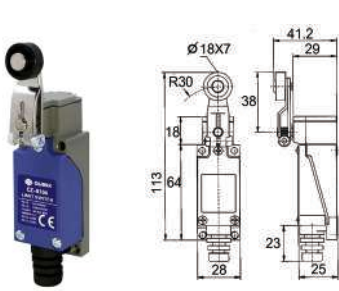

CZ-8104

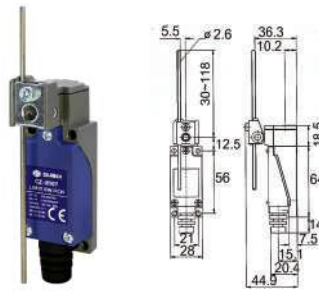

CZ-8107

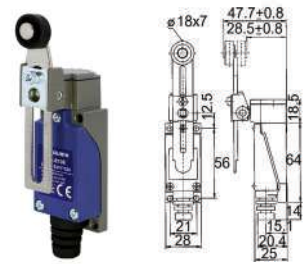

CZ-8108

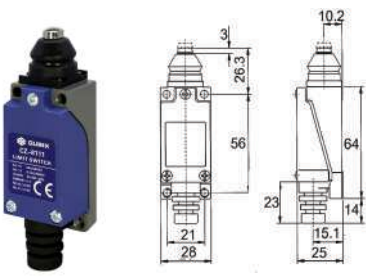

CZ-8111

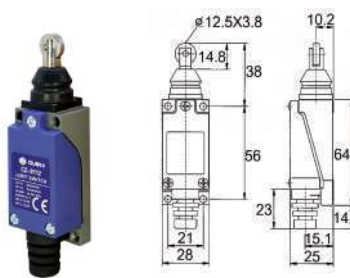

CZ-8112

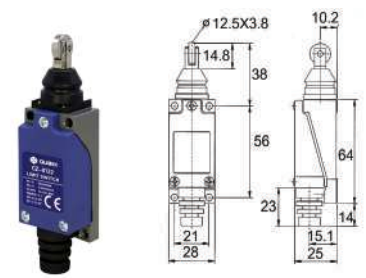

CZ-8122



บริษัท ซีที อิเล็กทริก ซัพพลาย จำกัด
CT ELECTRIC SUPPLY CO., LTD.

โทร : 02 550 9555

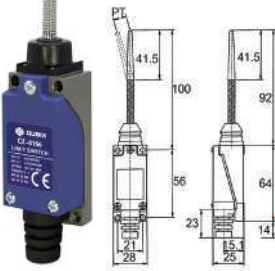

CZ-8166



CZ-8167

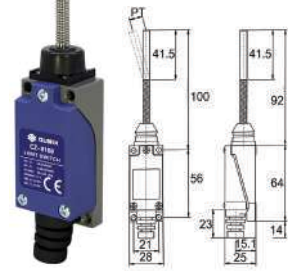

CZ-8168

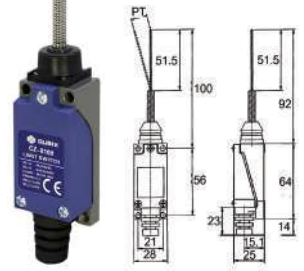

CZ-8169

CZ-8000 Series

รุ่น (Model)	ลักษณะ หน้าสัมผัสทำงาน	Rated Current / Voltage	Contact Type	Terminal Type	Packing Pcs/Box	ราคา/ตัว (บาท)
CZ-8104	Roller Lever	5A / 250V	DPDT 1NO, 1NC	SCREW TYPE	10	530.-
CZ-8107	Adjustable Rod Lever	5A / 250V	DPDT 1NO, 1NC		10	540.-
CZ-8108	Adjustable Roller Lever	5A / 250V	DPDT 1NO, 1NC		10	580.-
CZ-8111	Top Plunger	5A / 250V	DPDT 1NO, 1NC		10	470.-
CZ-8112	Roller Plunger	5A / 250V	DPDT 1NO, 1NC		10	480.-
CZ-8122	Cross Roller Plugner	5A / 250V	DPDT 1NO, 1NC		10	480.-
CZ-8166	Coil Spring With Plastic End	5A / 250V	DPDT 1NO, 1NC		10	520.-
CZ-8167	Coil Spring	5A / 250V	DPDT 1NO, 1NC		10	520.-
CZ-8168	Metal Stick	5A / 250V	DPDT 1NO, 1NC		10	520.-
CZ-8169	Spring wire	5A / 250V	DPDT 1NO, 1NC		10	520.-

* ราคาสินค้าไม่รวมภาษีมูลค่าเพิ่มและราคาอาจเปลี่ยนแปลงได้โดยไม่ต้องแจ้งให้ทราบล่วงหน้า *



โลกแข็งแรง ยืดอายุการใช้งาน



MAIN FEATURES :

- ✓ Metallic bottom shell
- ✓ Built-in contact stand has double-spring, so it has long mechanical life
- ✓ Strong electric property 10A, 250V for 500,000 times

Specification

Model - CHL	5000	5030	5050	5100	5200	5220	5300	5330
Operating force (max.)	750g-cm.	750g-cm.	750g-cm.	750g-cm.	900g-cm.	900g-cm.	150g.	150g.
Release force (min.)	100g-cm.	100g-cm.	100g-cm.	200g.	200g.	200g.	30g.	30g.
Pre-travel (max.)	20°	20°	20°	1.8mm.	1.8mm.	1.8mm.	30mm.	30mm.
Tripping position ±10%	22.5°	22.5°	22.5°	2.0mm.	2.0mm.	2.0mm.	22.5°	22.5°
Movement dif. (max.)	10°	10°	10°	0.2mm.	1.2mm.	1.2mm.	14°	14°
Over travel (min.)	75°	75°	75°	4.0mm.	4.0mm.	4.0mm.	20mm.	20mm.
Total travel (min.)	95°	95°	95°	5.8mm.	5.8mm.	5.8mm.	50mm.	50mm.

Characteristics

Double Break Mechanism	1NO+1NC Force break snap action
Rated Voltage / Current	10(4)A, 125, 250Vac / 6(2)A, 380Vac for inductance load, Cos ϕ = 0.4
Contact Resistance	25M Ω max.(initial value)
Insulation Resistance	100M Ω min.(at 500Vdc)
Dielectric Strength	1000Vac, 50/60Hz for 1 minute between terminal of the same polarity
	1500Vac, 50/60Hz for 1 minute between current-carrying and non-current-carrying metal parts
	1500Vac, 50/60Hz for 1 minute between each terminal and ground
Electrical Life	500,000 at 10A 250Vac Resistive
Mechanical Life	10,000,000 operations min.(under rated conditons)
Operating Speed	5mm/s to 0.5m/s
Degree of Protection	IP65
Ambient Temperature Rised	Max 30 °C over ambient temperature at rated voltage / current
Conformed Standards	Cenelec EN50041, EN50047, IEC337-1 and VDE0660
Operating Temperature	-5°C~+65°C(with no icing)
Storage Temperature	-5°C~+65°C(with no icing)
Ambient Operating Humidity	<95%RH
Shock Resistance	Mechanical durable: 1000m/s ² min.
	Malfunction: 300m/s ² min.
Vibration Frequency	Malfunction: 10 to 55Hz 1.5mm double amplitude
Terminal Screw Torsional Force	6-8 kgf-cm.
Other Screw Torsional Force	Cover 12-14 kgf-cm. / Head 8-9 kgf-cm. / Mounting 50-60 kgf-cm.
Bare Wire Diameter	ϕ 2 max.
Cable Diameter	ϕ 9 max.(IP65 if use cable ϕ 8-9)

* ราคาสินค้าไม่รวมภาษีมูลค่าเพิ่มและราคาอาจเปลี่ยนแปลงได้โดยไม่ต้องแจ้งให้ทราบล่วงหน้า *

IP65
ระดับการป้องกัน

CE

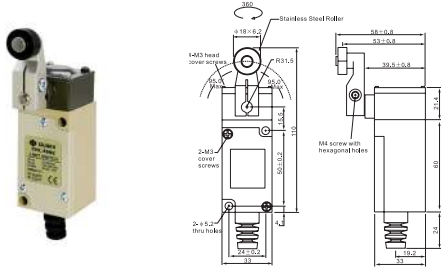

CHL-5000

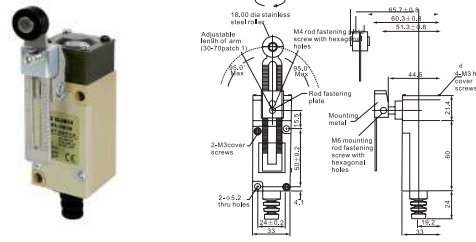

CHL-5030

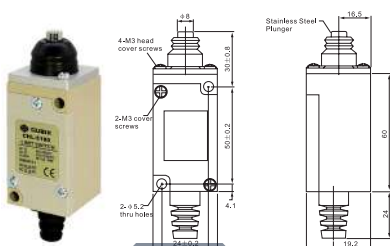

CHL-5100

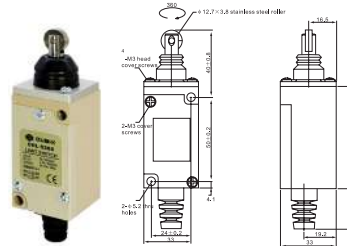

CHL-5200

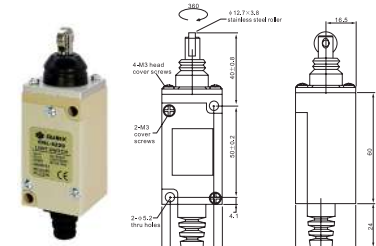

CHL-5220

บริษัท ซีที อิเล็กทริก ซัพพลาย จำกัด
CT ELECTRIC SUPPLY CO., LTD.

โทร : 02 550 9555

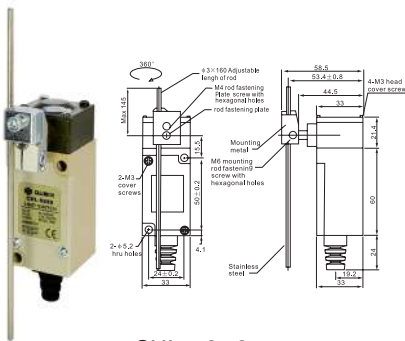

CHL-5050

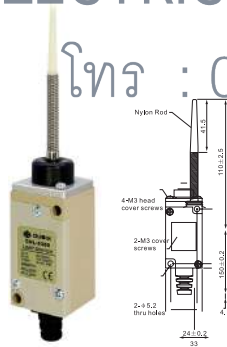

CHL-5300

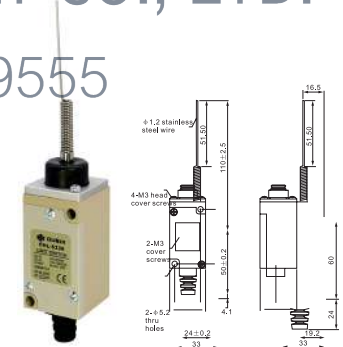

CHL-5330

CHL Series

รุ่น (Model)	ลักษณะ หน้าสัมผัสทำงาน	Rated Current / Voltage	Contact Type	Terminal Type	ราคา (บาท)
CHL-5000	Roller Lever	5A / 250V	DPDT 1NO, 1NC	SCREW TYPE	600.-
CHL-5030	Adjustable Roller Lever	5A / 250V	DPDT 1NO, 1NC		600.-
CHL-5050	Adjustable Rod Lever	5A / 250V	DPDT 1NO, 1NC		600.-
CHL-5100	Push Plunger	5A / 250V	DPDT 1NO, 1NC		520.-
CHL-5200	Roller Plunger	5A / 250V	DPDT 1NO, 1NC		540.-
CHL-5220	Cross Roller Plunger	5A / 250V	DPDT 1NO, 1NC		540.-
CHL-5300	Coil Spring With Plastic End	5A / 250V	DPDT 1NO, 1NC		550.-
CHL-5330	Spring wire	5A / 250V	DPDT 1NO, 1NC		550.-

* ราคาสินค้าไม่รวมภาษีมูลค่าเพิ่มและราคาอาจเปลี่ยนแปลงได้โดยไม่ต้องแจ้งให้ทราบล่วงหน้า *



ปลอดภัยกว่าด้วยกลไก Forced Disconnect
(ป้องกันการลอบติด)



IP66
ระดับการป้องกัน



Limit Switch C4B-Series

MAIN FEATURES :

- ✓ Forced open action device (NC contacts only), it can disconnect the contact when the contact has fusing and other failures.
- ✓ The set safety of lever ensures that gear ratcheting device is used between the action position indicator panel and the lever.
- ✓ Strengthened top seal structure improves the sealing performance.
- ✓ Built-in contact holder has fast-action type: 1NC / 1NO;
Slow-action: 1NC / 1NO and 2NC.

Forced disconnect fine of \ominus EN60947-5-1
(Only NC contact side has direct opening action function.)

- ① Welding occurs
- ② Tripping
- ③ Separation is completed

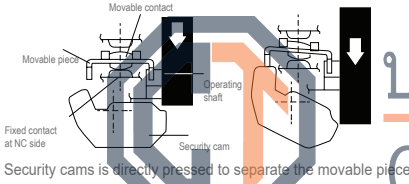

บริษัท ซีที อิเล็กทริก ซัพพลาย จำกัด
CT ELECTRIC SUPPLY CO., LTD.

Performance	
Protection Level	IP66
Mechanical Life	More than 10,000,000 times*5
Electrical Life	More than 500,000 times(250Vac 10A, resistive load)
Operation Speed	1mm~0.5m/s
Operation Frequency	Mechanical: 120 times/min
	Electrical: 30 times/min
Rated Frequency	50/60Hz
Insulation resistance	100M Ω or more (DC500V Megameter) between homopolars, and between terminals and uncharged metal parts
Contact resistance	25M Ω or less (initial value)
Withstand Voltage (EN60947-5-1)	Between homopolar terminals: 2.5kV(quick-action type) / 4kV(slow-action type)
	Between heteropolar terminals: 2.5kV(slow-action type)
	Between charged metal parts: 4kV
	Between terminals and uncharged metal parts: 6kV
Rated Insulation Voltage (U _i)	600V(EN60947-5-1)
Reverse Voltage when on/off	150V max.(EN60947-5-1)
Pollution degree (environmental conditions)	Pollution degree 3(EN60947-5-1)
Electric shock proof protection grade	Class I (with ground terminal)
Vibration	Malfunction: 10~55Hz 0.75mm single amplitude
	Duration: 1,000m/s ²
Shock resistant	Malfunction: 300m/s ²
Ambient Temperature	-20°C~+80°C(No ice or dew)
Ambient Humidity	Less than 95%RH
Weight	250g

Rated voltage (V)	Non-inductive load(A)				Inductive load(A)			
	Resistive load		lamp load		Inductive load		Motor load	
	NC	NO	NC	NO	NC	NO	NC	NO
AC	125	10	3	1.5	10	5	2.5	
	250	10	2	1	10	3	1.5	
	400	10	1.5	0.8	3	1.5	0.8	
DC	8	10	6	3	10	6		
	14	10	6	3	10	6		
	30	6	4	3	6	4		
	125	0.8	0.2	0.2	0.8	0.2		
	250	0.4	0.1	0.1	0.4	0.1		

Action characteristics

Action characteristics			15N	12N	17N	18N	70N	71N	72N	81N	86N	87N
Action force	OF	Max.	9.41N	9.41N	2.12N	9.41N	18.63N	18.63N	18.63N	1.47N	1.47N	1.47N
	RF	Min.	1.47	1.47N	0.29N	1.47N	1.96N	1.96N	1.96N	-	-	-
Pretravel	PT	-	21° ±3°	21° ±3°	21° ±3°	21° ±3°	2mm.	2mm.	2mm.	15	15	15
	PT	(2nd)	(45°)	(45°)	(45°)	(45°)	(3mm.)	(3mm.)	(3mm.)	-	-	-
Overtravel	OT	Min.	50°	50°	50°	50°	5mm.	5mm.	5mm.	-	-	-
Poor response travel	MD	Max.	12°	12°	12°	12°	1mm.	1mm.	1mm.	-	-	-
Force disconnected pretravel	DOT	Min.	35°	35°	35°	35°	3.2mm.	3.2mm.	3.2mm.	-	-	-
	DOT	Min.	55°	55°	55°	55°				-	-	-
Force disconnected force	DOF	Min.	19.61N	19.61N	19.61N	19.61N	49.03N	49.03N	49.03N	-	-	-
Total travel	TT	-	(75°)	(75°)	(75°)	(75°)	(7mm.)	(7mm.)	(7mm.)	-	-	-
Free position	FP	Max.	-	-	-	-	38mm.	51mm.	51mm.	-	-	-
Action position	OP	-	-	-	-	-	35±1mm.	48±1mm.	48±1mm.	-	-	-

* ราคาสินค้าไม่รวมภาษีมูลค่าเพิ่มและราคาอาจเปลี่ยนแปลงได้โดยไม่ต้องแจ้งให้ทราบล่วงหน้า *

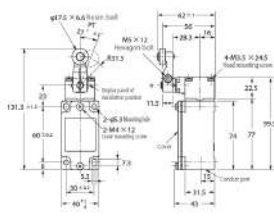

C4B-4112N

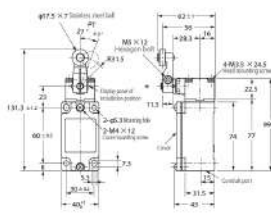

C4B-4115N

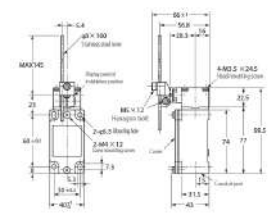

C4B-4117N

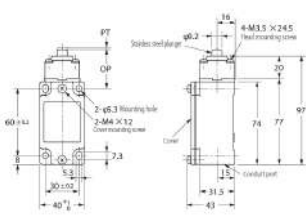

C4B-4170N

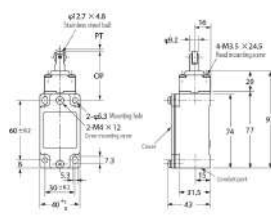

C4B-4171N

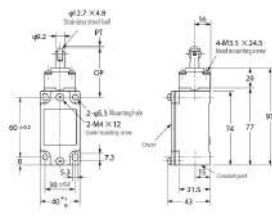

C4B-4172N



บริษัท ซีที อีเล็คทริค ซัพพลาย จำกัด
CT ELECTRIC SUPPLY CO., LTD.

โทร 02 550 9555

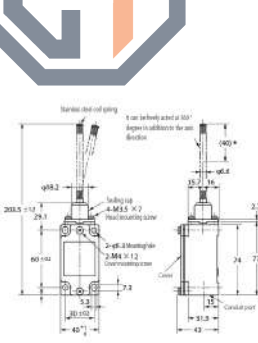

C4B-4181N

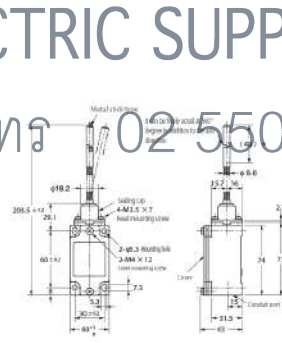

C4B-4186N

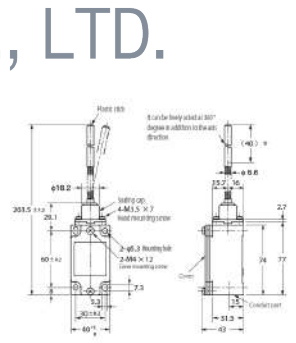

C4B-4187N

C4B Series					
รุ่น (Model)	ลักษณะ หน้าสัมผัสทำงาน	Rated Current / Voltage	Contact Type	Terminal Type	ราคา (บาท)
C4B-4112N	Adjustable Roller Lever	10A / 250V	DPDT 1NO, 1NC	SCREW TYPE	1,190.-
C4B-4115N	Roller Lever	10A / 250V	DPDT 1NO, 1NC		1,170.-
C4B-4117N	Adjustable Rod Lever	10A / 250V	DPDT 1NO, 1NC		1,160.-
C4B-4170N	Top Plunger	10A / 250V	DPDT 1NO, 1NC		1,100.-
C4B-4171N	Roller Plunger	10A / 250V	DPDT 1NO, 1NC		1,120.-
C4B-4172N	Cross Roller Plunger	10A / 250V	DPDT 1NO, 1NC		1,120.-
C4B-4181N	Coil Spring	10A / 250V	DPDT 1NO, 1NC		1,080.-
C4B-4186N	Metal Stick	10A / 250V	DPDT 1NO, 1NC		1,080.-
C4B-4187N	Coil Spring With Plastic End	10A / 250V	DPDT 1NO, 1NC		1,080.-

* ราคาสินค้าไม่รวมภาษีมูลค่าเพิ่มและราคาอาจเปลี่ยนแปลงได้โดยไม่ต้องแจ้งให้ทราบล่วงหน้า *

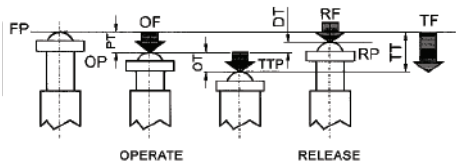

OF : Operating Force
 RF : Releasing Force
 TF : Total Force
 FP : Free Position
 OP : Operating Position
 RP : Releasing Position

TTP : Total Travel Position
 PT : Pretravel
 OT : Overtravel
 DT : Travel Differential
 TT : Total Travel

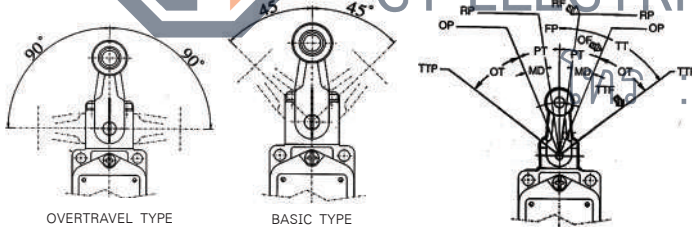

Note:

1. Inductive loads have a power factor of 0.4min.(AC) and a time constant of 7 ms max.(DC).
2. Lamp load has an inrush current of 10 times the steady-state current.
3. Motor load has an inrush current of 6 times the steady-state current

MAIN FEATURES :

- ✓Double-circuit type of limit switch, is widely used
- ✓With strong aluminum cast outer shell
- ✓High mechanical strength
- ✓Structure preventing oil, water and pressure
- ✓Indicating plate with setting position is installed in it, so it is easy to maintain
- ✓Various actuators is taken convenience for using
- ✓Built-in contact stand has double-spring, so it has longmechanical life
- ✓Standard size configuration M20x1.5 for conduit connector

Operating speed	1mm/sec to 2m/sec (with Type WLCA2)
Operating frequency	Mechanical : 120 operations/min. Electrical : 30 operations/min.
Contact resistance	15M Ω max. (initial)
Insulation resistance	100M Ω min. (at 500 VDC)
Dielectric strength	1000 VAC, 50/60 Hz for 1 minute between terminals of the same polarity 1500 VAC, 50/60 Hz for 1 minute between current-carrying and noncurrent-carrying metal parts 1500 VAC, 50/60 Hz for 1 minute between each terminal and ground
Vibration	Malfunction durability : 10 to 55Hz; 1.5mm double amplitude
Shock	Mechanical durability : Approx. 1,000m/sec ² (approx. 100G's) Malfunction durability : Approx. 300m/sec ² (approx. 30G's)
Ambient temperature	Operating: -10°C to +80°C (With no icing)
Humidity	95% RH max.
Service life	Mechanical : 15,000,000 operations above (under rated OT) Electrical : 500,000 operations above
Degree of protection	IP66

Rated Voltage	Non-inductive load				Inductive load			
	Resistive Load		Lamp Load		Inductive load		Motor Load	
	N.C.	N.O.	N.C.	N.O.	N.C.	N.O.	N.C.	N.O.
125 VAC	10	10	3	1.5	10	10	5	2.0
250 VAC	5	5	2	1	5	5	3	1.0
8 VDC	10	10	6	3	10	10	6	6
30 VDC	6	6	4	3	6	6	4	4
125 VDC	0.8	0.8	0.2	0.2	0.8	0.8	0.2	0.2

Types of actuator	Model	OF max (g.)	RF min (g.)	PT max (mm.)	OT min (mm.)	MD max (mm.)	TF max (g.)	TT max	OP (mm.)
Roller Lever	CWLCA2-2	1360	227	20°	30°	12°	2720	50°	-
Adjustable Roller Lever	CWLCA12-2-Q	1360	227	20°	30°	12°	2720	50°	-
Adjustable Rod Lever	CWLCL	142	28	20°	30°	12°	200	50°	-
Fork Lever Lock	CWLCA32-41	1200	-	55°	35°	-	-	90 ± 10°	-
Fork Lever Lock	CWLCA32-42								
Top Plunger	CWLD	2720	910	1.7	6.4	1	-	34 ± 2.8	-
Cross Roller Plugner	CWLD1	2720	910	1.7	5.6	1	2720	6.5 ± 0.8	-
Roller Plunger	CWLD2	2720	910	1.7	5.6	1	-	6.5 ± 0.8	-
Ball Plunger	CWLD3	2720	910	1.7	5.6	1	2720	9 ± 0.8	-
Coil Spring (6.5 dia.)	CWLNJ	150	-	28	-	-	-	-	-
Coil Spring With Plastic End (8.0 dia.)	CWLNJ-2	120	-	28	-	-	-	-	-
Metal Stick (5.0 dia.)	CWLNJ-30	80	-	28	-	-	-	-	-
Spring Wire (1.0 dia.)	CWLNJ-S2	29	-	28	-	-	-	-	-

* ราคาสินค้าไม่รวมภาษีมูลค่าเพิ่มและราคาอาจเปลี่ยนแปลงได้โดยไม่ต้องแจ้งให้ทราบล่วงหน้า *

✓ กลไกแข็งแรง คุณสมบัตหลากหลาย

IP66
ระดับการป้องกัน

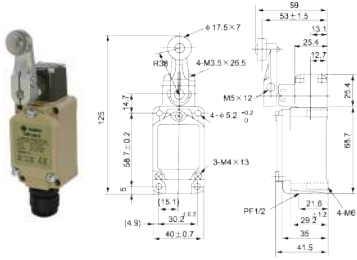

CWLCA2-2

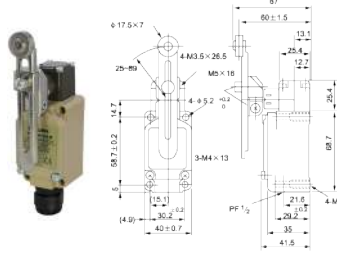

CWLCA12-2-Q

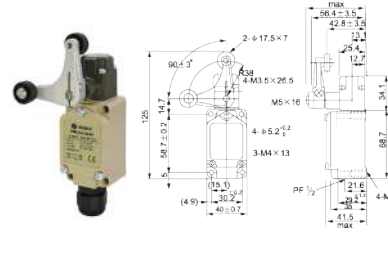

CWLCA32-41



CWLCA32-42

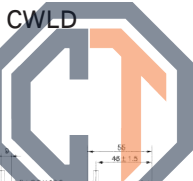
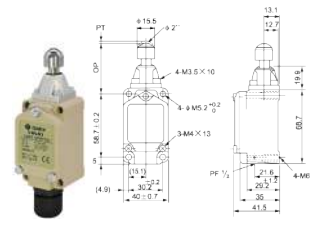
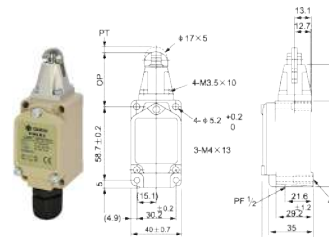
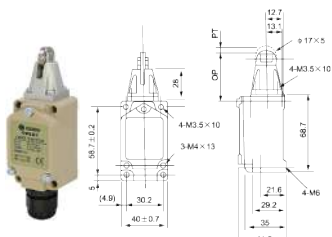
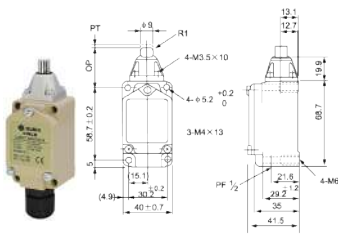

บริษัท ซีที อิเล็กทริค ซัพพลาย จำกัด
CTELECTRIC SUPPLY CO., LTD.

โทร 02 550 9555

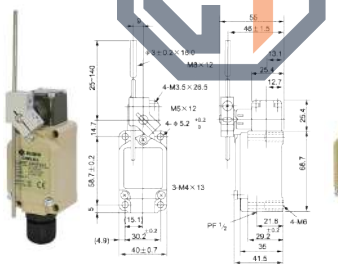

CWLCL

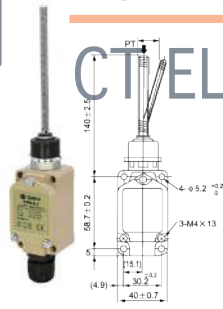

CWLNJ

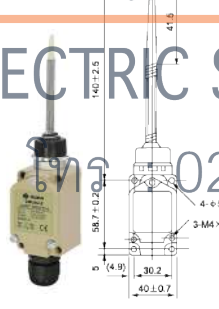

CWLNJ2



CWLNJ30

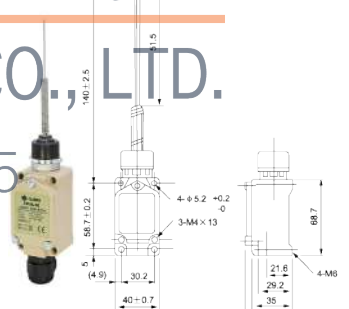

CWLNJ-S2

CWL-Series

รุ่น (Model)	ลักษณะ หน้าสัมผัสทำงาน	Rated Current / Voltage	Contact Type	Terminal Type	ราคา (บาท)
CWLCA2-2	Roller Lever	10A / 250V	DPDT 1NO, 1NC	SCREW TYPE	800.-
CWLCA12-2-Q	Adjustable Roller Lever	10A / 250V	DPDT 1NO, 1NC		800.-
CWLCL	Adjustable Rod Lever	10A / 250V	DPDT 1NO, 1NC		750.-
CWLCA32-41	Fork Lever Lock	10A / 250V	DPDT 1NO, 1NC		980.-
CWLCA32-42	Fork Lever Lock	10A / 250V	DPDT 1NO, 1NC		980.-
CWLD	Top Plunger	10A / 250V	DPDT 1NO, 1NC		680.-
CWLD1	Cross Roller Plunger	10A / 250V	DPDT 1NO, 1NC		700.-
CWLD2	Roller Plunger	10A / 250V	DPDT 1NO, 1NC		700.-
CWLD3	Ball Plunger	10A / 250V	DPDT 1NO, 1NC		750.-
CWLNJ	Coil Spring (6.5 dia.)	10A / 250V	DPDT 1NO, 1NC		680.-
CWLNJ2	Coil Spring With Plastic End (8.0 dia.)	10A / 250V	DPDT 1NO, 1NC		680.-
CWLNJ30	Metal Stick (5.0 dia.)	10A / 250V	DPDT 1NO, 1NC		680.-
CWLNJ-S2	Spring Wire (1.0 dia.)	10A / 250V	DPDT 1NO, 1NC	680.-	

* ราคาสินค้าไม่รวมภาษีมูลค่าเพิ่มและราคาอาจเปลี่ยนแปลงได้โดยไม่ต้องแจ้งให้ทราบล่วงหน้า *



MS-190...VAC

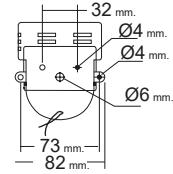
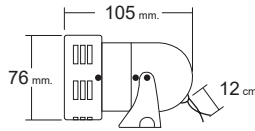
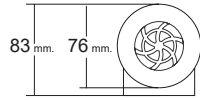

MS-190...VDC

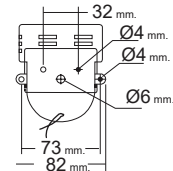
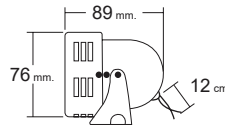
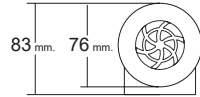

MS-290

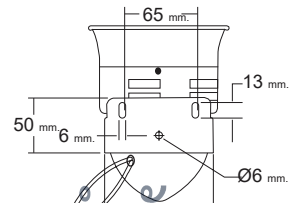
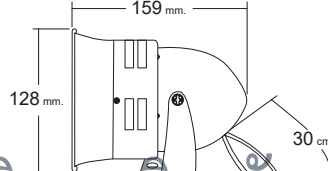
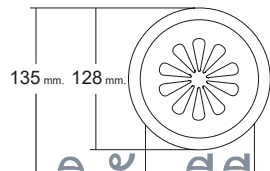

MS-390

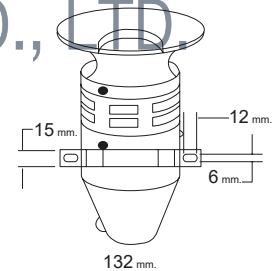
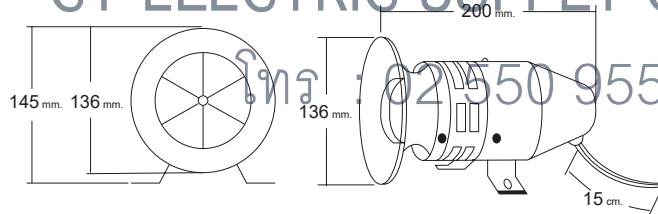

บริษัท ซีที อิเล็กทริค ซัพพลาย จำกัด
CT ELECTRIC SUPPLY CO., LTD

โทร : 02-550 9555

รุ่น (Model)	Rated Voltage	Frequency (Hz)	Rated Current	Power (W)	Sound Output dB(A) 1m	Continuous running time	Degree Of Protection	Material	Color	ราคา (บาท)
MS-190	12 VDC	-	2.50A	30W	100 dB	5-8 Min	IP 44	Steel	Red	550.-
MS-190	24 VDC	-	1.55A	38W	100 dB	5-8 Min	IP 44			550.-
MS-190	110 VAC	50/60	0.42A	45W	100 dB	5-8 Min	IP 44			550.-
MS-190	220 VAC	50/60	0.20A	45W	100 dB	5-8 Min	IP 44			550.-
MS-290	12 VDC	-	3.55A	45W	105 dB	5-8 Min	IP 44	Steel	Gray	900.-
MS-290	24 VDC	-	2.00A	45W	105 dB	5-8 Min	IP 44			900.-
MS-290	110 VAC	50/60	0.70A	75W	105 dB	5-8 Min	IP 44			900.-
MS-290	220 VAC	50/60	0.375A	80W	105 dB	5-8 Min	IP 44			900.-
MS-390	12 VDC	-	5.35A	65W	115 dB	5-8 Min	IP 44	Aluminum and Steel	Red	1,950.-
MS-390	24 VDC	-	2.80A	68W	115 dB	5-8 Min	IP 44			1,950.-
MS-390	110 VAC	50/60	1.33A	145W	115 dB	5-8 Min	IP 44			1,950.-
MS-390	220 VAC	50/60	0.68A	150W	115 dB	5-8 Min	IP 44			1,950.-

* ราคาสินค้าไม่รวมภาษีมูลค่าเพิ่มและราคาอาจเปลี่ยนแปลงได้โดยไม่ต้องแจ้งให้ทราบล่วงหน้า *

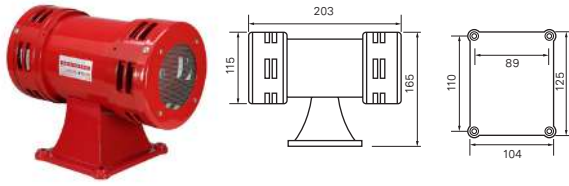

MS-490

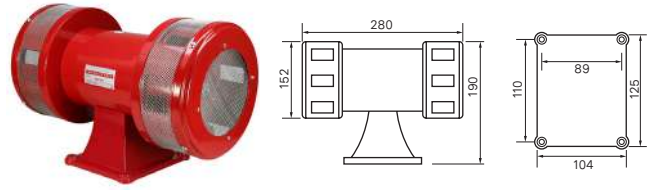

MS-590

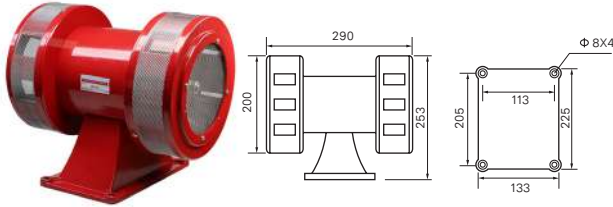

MS-690

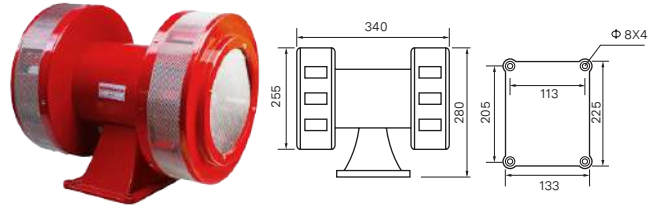

MS-790

รุ่น (Model)	Rated Voltage	Frequency (Hz)	Rated Current	Power (W)	Sound Output dB(A) 1m	Continuous running time	Degree Of Protection	Material	Color	ราคา (บาท)
MS-490	110 VAC	50/60	2.35A	250W	150 dB	5-8 Min.	IP 44	Aluminum and Steel	Red	8,800.-
MS-490	220 VAC	50/60	1.15A	250W	150 dB	5-8 Min.	IP 44			8,800.-
MS-590	220 VAC	50/60	1.8A	400W	160 dB	5-8 Min.	IP 44			18,800.-
MS-690	220 VAC	50/60	2A	450W	170 dB	5-8 Min.	IP 44			27,800.-
MS-790	220 VAC	50/60	2.2A	500W	180 dB	5-8 Min.	IP 44			30,000.-

บริษัท ซีที อีเลคทริก ซัพพลาย จำกัด
CT ELECTRIC SUPPLY CO., LTD.

โทร : 02 550 9555

Table The Range Of Sound (theoretical)

Distance

M	dB(A) ±3																												
1	65	70	75	80	85	90	92	94	96	98	100	102	104	106	108	110	112	114	116	118	120	122	124	126	128	130	132	134	136
2	59	64	69	74	79	84	86	88	90	92	94	96	98	100	102	104	106	108	110	112	114	116	118	120	122	124	126	128	130
3	55	60	65	70	75	80	82	84	86	88	90	92	94	96	98	100	102	104	106	108	110	112	114	116	118	120	122	124	126
5	51	56	61	66	71	76	78	80	82	84	86	88	90	92	94	96	98	100	102	104	106	108	110	112	114	116	118	120	122
10	45	50	55	60	65	70	72	74	76	78	80	82	84	86	88	90	92	94	96	98	100	102	104	106	108	110	112	114	116
20	39	44	49	54	59	64	66	68	70	72	74	76	78	80	82	84	86	88	90	92	94	96	98	100	102	104	106	108	110
30	35	40	45	50	60	62	64	66	68	70	72	74	76	78	80	82	84	86	88	90	92	94	96	98	100	101	102	104	106
50	=	36	41	46	51	56	58	60	62	64	66	68	70	72	74	76	78	80	82	84	86	88	90	92	94	96	98	100	102
100	=	=	40	45	50	52	54	56	58	60	62	64	66	68	70	72	74	76	78	80	82	84	86	88	90	92	94	96	
200			=	39	44	48	46	50	52	54	56	58	60	62	64	66	68	70	72	74	76	78	80	82	84	86	88	90	
300			=	40	42	44	46	48	50	52	54	56	58	60	62	64	66	68	70	72	74	76	78	80	82	84	86		
500			=	38	40	42	44	46	48	50	52	54	56	58	60	62	64	66	68	70	72	74	76	78	80	82			
1000			=	=	=	38	40	42	44	46	48	50	52	54	56	58	60	62	64	66	68	70	72	74	76				
2000			=	=	=	38	40	42	44	46	48	50	52	54	56	58	60	62	64	66	68	70							
3000			=	=	=	38	40	42	44	46	48	50	52	54	56	58	60	62	64	66									
5000			=	=	=	38	40	42	44	46	48	50	52	54	56	58	60	62											

* ราคาสินค้าไม่รวมภาษีมูลค่าเพิ่มและราคาอาจเปลี่ยนแปลงได้โดยไม่ต้องแจ้งให้ทราบล่วงหน้า *



FEATURES

- Standard color : White
- Rated Temp. scope : -60°C ~ +200°C
- Rated voltage : 300V / 500V
- Conductor : Solid or stranded silvering or nickeling conductors, nickel or tinned coppering conductors.
- Quality standard : UL
- Insulation : High temperature resistant silicone rubber insulation
- Use : Electrical source wiring for the internal high temperature surroundings of equipments such as electrical appliances, lamps and lanterns and electric machineries

SGB Series		100m/roll
รายละเอียด (Details)	Conductor Diameter	ราคา/100เมตร (บาท)
SGB	0.5 mm ²	1,750.-
SGB	0.75 mm ²	2,130.-
SGB	1.0 mm ²	2,450.-
SGB	1.5 mm ²	3,100.-
SGB	2.0 mm ²	4,000.-
SGB	2.5 mm ²	5,000.-
SGB	4.0 mm ²	7,800.-
SGB	6.0 mm ²	11,500.-
SGB	10.0 mm ²	19,650.-
SGB	16.0 mm ²	30,500.-
SGB	25.0 mm ²	54,500.-
SGB	35.0 mm ²	81,500.-
SGB	50.0 mm ²	115,000.-
SGB	70.0 mm ²	138,500.-



บริษัท ซีที อิเล็กทริค ซัพพลาย จำกัด
 Tinning Copper Conductor | Silicone Rubber Insulation | Fiberglass Braid

CT ELECTRIC SUPPLY CO., LTD.

โทร : 02 550 9555



อุปกรณ์ที่ใช้ร่วมกัน
 หน้า 6,11,16,22,25
 (Section 2)

SPECIFICATIONS:

Conductor			Insulation Thickness (mm.)	Over All Wire Dia. (mm.)	Max. Conductor Resistance	
Normal Size (mm ²)	Strand/Dia. No/(mm.)	Diameter (mm.)			300V / 500V	300V / 500V
0.5	16/0.20	0.94	0.40	2.14	40.10	12.23
0.75	24/0.20	1.20	0.40	2.30	26.70	8.14
1.0	32/0.20	1.34	0.40	2.60	20.00	6.10
1.5	48/0.20	1.70	0.40	2.90	13.70	4.18
2.0	42/0.25	1.90	0.60	3.50	9.48	2.89
2.5	50/0.25	2.10	0.60	3.84	8.21	2.51
4.0	32/0.40	2.61	0.70	4.45	5.09	1.55
6.0	48/0.40	3.30	0.80	5.34	3.39	1.03
10.0	80/0.40	4.20	1.00	6.64	1.95	0.60
16.0	127/0.40	5.90	1.00	8.50	1.24	0.38
25.0	196/0.40	6.80	1.2	10.00	0.795	0.243
35.0	276/0.40	8.60	1.2	11.80	0.565	0.173
50.0	396/0.40	10.40	1.2	13.90	0.393	0.12
70.0	577/0.40	13.00	1.2	16.20	0.277	0.085

* ราคาสินค้าไม่รวมภาษีมูลค่าเพิ่มและราคาอาจเปลี่ยนแปลงได้โดยไม่ต้องแจ้งให้ทราบล่วงหน้า *



คุณสมบัติหลัก MAIN FEATURES :

- ✓ กลไกสวิตช์แข็งแรงทนทาน (Reliable cam action switch mechanism.)
- ✓ เทอร์มินอลเข้าสายง่าย (Universal terminals with easy installation.)
- ✓ มีเทอร์มินอลสำหรับสายกราวด์ (Green hex-head deep slotted terminal for grounding.)
- ✓ สกรูเทอร์มินอลขนาดใหญ่แบบหลบหัวสกรู
(Terminal screw are large binding head, staked and backed out.)



S115B

S120B

S711B

สวิตช์

รุ่น (Model)	รายละเอียดสินค้า (Details)	Rated Current / Voltage	สี (Color)	จำนวนต่อกล่อง (Pcs./box)	ราคา/ตัว (บาท)
S115B	สวิตช์เดี่ยวทางเดียว	15A / 120/277V	Brown	10 Pcs.	110.-
S120B	สวิตช์เดี่ยวทางเดียว	20A / 120/277V		10 Pcs.	145.-
S711B	สวิตช์คู่ทางเดียว	10A / 120V		10 Pcs.	165.-

FEATURES:

- ผลิตจากวัสดุไม่ลามไฟ (Molded of non-flammable material.)
- คุณภาพของพื้นผิวและสีเรียบร้อยสวยงามมีทั้งพลาสติกและสแตนเลสสตีล (Smooth surface, color match, long steel mounting screw furnished.)
- สามารถป้องกันน้ำและฝุ่นในรุ่นกันน้ำ(F1961 และ F1962)
(For Weather protective Series: Protective covers protect against rain, humidity, dust and other contaminants. Non-corroding part of brass, alluminum and stainless steel.)

บริษัท ซีที อิเล็กทริก ซัพพลาย จำกัด
CT ELECTRIC SUPPLY CO., LTD.

โทร : 02-550-9555



F2132S (Stainless)



F2134S



F1961



F1962

ฝาครอบตัวรับและสวิตช์

รุ่น (Model)	รายละเอียดสินค้า (Details)	ใช้กับสวิตช์/ตัวรับไฟฟ้า	สี (Color)	จำนวนต่อกล่อง (Pcs./box)	ราคา/ตัว (บาท)
F2132S	ฝาตัวรับคู่ สแตนเลส	R270U , R826	-	25 Pcs.	50.-
F2134B	ฝาสวิตช์เดี่ยว พลาสติก	S115B , S120B	Brown	25 Pcs.	20.-
F2134S	ฝาสวิตช์เดี่ยว สแตนเลส	S115B , S120B	-	25 Pcs.	50.-
F1961	ฝาเดี่ยวกันน้ำ พลาสติก	S115B , S120B	Grey	10 Pcs.	100.-
F1962	ฝาคู่กันน้ำ พลาสติก	R270U , R826 , S711B	Grey	10 Pcs.	120.-

* ราคาสินค้าไม่รวมภาษีมูลค่าเพิ่มและราคาอาจเปลี่ยนแปลงได้โดยไม่ต้องแจ้งให้ทราบล่วงหน้า *



เต้ารับ (Receptacles)

รุ่น (Model)	Details	NEMA	Poles	Rated Current / Voltage	Color	Pcs/Box	ราคา/ตัว (บาท)
R270U-B	เต้ารับคู่มือกราวด์ (Universal Type)	-	2P 3W	15A/250Vac	Brown	10	100.-
R270U-R	เต้ารับคู่มือกราวด์ (Universal Type)	-	2P 3W	15A/250Vac	Red	10	100.-
R270U-V	เต้ารับคู่มือกราวด์ (Universal Type)	-	2P 3W	15A/250Vac	Ivory	10	100.-
R270U-Y	เต้ารับคู่มือกราวด์ (Universal Type)	-	2P 3W	15A/250Vac	Yellow	10	100.-
R270U-O	เต้ารับคู่มือกราวด์ (Universal Type)	-	2P 3W	15A/250Vac	Orange	10	100.-
R270U-G	เต้ารับคู่มือกราวด์ (Universal Type)	-	2P 3W	15A/250Vac	Fluorescent Green	10	100.-
R298-V	เต้ารับคู่มือกราวด์	5-15P	2P 3W	15A/125Vac	Ivory	10	80.-
R826-B	เต้ารับคู่มือกราวด์	6-15P	2P 3W	15A/250Vac	Brown	10	130.-
R826-V	เต้ารับคู่มือกราวด์	6-15P	2P 3W	15A/250Vac	Ivory	10	130.-



ฝาพลาสติก (Wall plates)

รุ่น (Model)	Details	ใช้กับเต้ารับไฟฟ้า	Color	Pcs./box	ราคา/ตัว (บาท)
F2132B	ฝาพลาสติก	R270U , R826	Brown	25 Pcs.	20.-
F2132O			Orange	25 Pcs.	20.-
F2132V			Ivory	25 Pcs.	20.-
F2132Y			Yellow	25 Pcs.	20.-

* ราคาสินค้าไม่รวมภาษีมูลค่าเพิ่มและราคาอาจเปลี่ยนแปลงได้โดยไม่ต้องแจ้งให้ทราบล่วงหน้า *

Quality system

ISO9001:2000 International Quality management system
Thermoplastic rubber plugs & connector
Commercial Grade (NEMA Type)



P1723



P1709



P1711

ปลั๊กตัวผู้ (Plugs)

รุ่น (Model)	Details	NEMA	Poles	Rated Current / Voltage	Color	Pcs/Box	ราคา/ตัว (บาท)
P1723	ปลั๊กยางตัวผู้มีแคล้มรัด	1-15P	2P 2W	15A/125Vac	Black	10	70.-
P1709	ปลั๊กยางตัวผู้มีแคล้มรัด	5-15P	2P 3W	15A/125Vac	Black	10	85.-
P1711	ปลั๊กยางตัวผู้มีแคล้มรัด	6-15P	2P 3W	15A/250Vac	Black	10	90.-

โทร : 02 550 9555



C224



C222



C229

เต้ารับกลางทาง (Connector)

รุ่น (Model)	Details	NEMA	Poles	Rated Current / Voltage	Color	Pcs/Box	ราคา/ตัว (บาท)
C224	เต้ารับยางกลางทางมีแคล้มรัด	1-15P	2P 2W	15A/125Vac	Black	10	95.-
C222	เต้ารับยางกลางทางมีแคล้มรัด	5-15P	2P 3W	15A/125Vac	Black	10	120.-
C229	เต้ารับยางกลางทางมีแคล้มรัด	6-15P	2P 3W	15A/250Vac	Black	10	135.-

* ราคาสินค้าไม่รวมภาษีมูลค่าเพิ่มและราคาอาจเปลี่ยนแปลงได้โดยไม่ต้องแจ้งให้ทราบล่วงหน้า *



ปลั๊กตัวผู้ (Schuko Plug)

รุ่น (Model)	Pole	Rated Voltage	Rated Current	Color	ราคา/ตัว (บาท)
10749	2P+E	250Vac	16A	WHITE	130.-
10838	2P+E	250Vac	16A	BLUE	130.-
10839	2P+E	250Vac	16A	RED	130.-
10840	2P+E	250Vac	16A	YELLOW	130.-



เต้ารับฝั่ง (Schuko Socket)

รุ่น (Model)	Pole	Rated Voltage	Rated Current	Color	ราคา/ตัว (บาท)
11030	2P+E	250Vac	16A	GREY	140.-
11032	2P+E	250Vac	16A	BLACK	140.-
11033	2P+E	250Vac	16A	RED	140.-



บริษัท ซีที อิเล็กทริค ซัพพลาย จำกัด

CT ELECTRIC SUPPLY CO., LTD.



โทร : 02 550 9555



UKW-TS



UKW-2TS



UKW-1GTS



เต้ารับลอยกันน้ำ (IP55)

รุ่น (Model)	Pole	Rated Voltage	Rated Current	Color	ราคา/ตัว (บาท)
UKW-TS	2P+E	250Vac	16A	GREY	220.-
UKW-2TS	2P+E	250Vac	16A	GREY	360.-

สวิตช์+เต้ารับลอยกันน้ำ (IP55)

รุ่น (Model)	Pole	Rated Voltage	Rated Current	Color	ราคา/ตัว (บาท)
UKW-1GTS	2P+E	250Vac	16A	GREY	280.-

* ราคาสินค้าไม่รวมภาษีมูลค่าเพิ่มและราคาอาจเปลี่ยนแปลงได้โดยไม่ต้องแจ้งให้ทราบล่วงหน้า *



AJ-013L

AJ-014L

AJ-015L

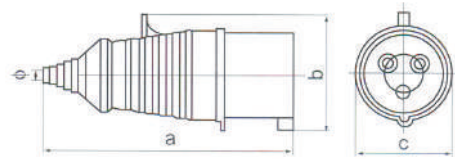

AJ-023L

AJ-024L

AJ-025L

Earth contact position	6h						
	3		4		5		
Pole	3	4	3	4	3	4	
Rated current(A)	16	32	16	32	16	32	
Dimension(mm.)	a	142	171	142	171	161	174
	b	57	77	64	77	75	87
	c	50	64	50	64	64	70
	∅	7-16	7-20	7-16	7-20	7-20	7-20

ปลั๊ก (Plugs) Conform to IEC60309-2									
Degree of Protection	รุ่น (Model)	Pole	Color code / Earth contact position (6h)	Rated Voltage	Rated Current	Cable size (mm ²)	Packing		ราคา/ตัว (บาท)
							Pcs/Box	Pcs/Ctn	
IP44	AJ-013L	2P+E		220-240Vac (50/60Hz)	16A	1 - 2.5	10	120	100.-
	AJ-023L				32A	2.5 - 6	10	60	150.-
	AJ-014L	3P+E		380-415Vac (50/60Hz)	16A	1 - 2.5	10	120	130.-
	AJ-024L				32A	2.5 - 6	10	60	170.-
	AJ-015L	3P+N+E		220-415Vac (50/60Hz)	16A	1 - 2.5	10	60	150.-
	AJ-025L				32A	2.5 - 6	10	60	190.-



AJ-113L

AJ-114L

AJ-115L

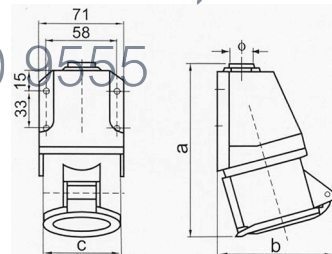

AJ-123L

AJ-124L

AJ-125L

Earth contact position	6h						
	3		4		5		
Pole	3	4	3	4	3	4	
Rated current(A)	16	32	16	32	16	32	
Dimension(mm.)	a	135	153	140	152	139	153
	b	92	102	95	104	96	107
	c	50	65	56	65	63	70
	∅	3-18	3-18	3-18	3-18	3-18	3-18

เต้ารับลอยติดผนัง (Wall Socket) Conform to IEC60309-2									
Degree of Protection	รุ่น (Model)	Pole	Color code / Earth contact position (6h)	Rated Voltage	Rated Current	Cable size (mm ²)	Packing		ราคา/ตัว (บาท)
							Pcs/Box	Pcs/Ctn	
IP44	AJ-113L	2P+E		220-240Vac (50/60Hz)	16A	1 - 2.5	10	60	175.-
	AJ-123L				32A	2.5 - 6	10	60	250.-
	AJ-114L	3P+E		380-415Vac (50/60Hz)	16A	1 - 2.5	10	60	190.-
	AJ-124L				32A	2.5 - 6	10	60	280.-
	AJ-115L	3P+N+E		220-415Vac (50/60Hz)	16A	1 - 2.5	10	60	210.-
	AJ-125L				32A	2.5 - 6	10	60	300.-

* ราคาสินค้าไม่รวมภาษีมูลค่าเพิ่มและราคาอาจเปลี่ยนแปลงได้โดยไม่ต้องแจ้งให้ทราบล่วงหน้า *



AJ-213L

AJ-214L

AJ-215L

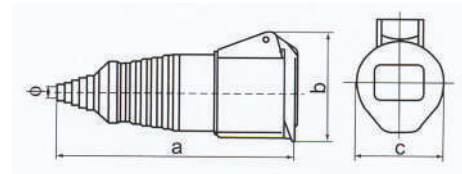

AJ-223L

AJ-224L

AJ-225L

Earth contact position		6h					
Pole		3		4		5	
Rated current(A)		16	32	16	32	16	32
Dimension(mm.)	a	150	182	150	182	171	185
	b	69	94	79	94	93	101
	c	50.5	65	56	65	64	71
	Ø	7-16	7-20	7-16	7-20	7-20	7-20

เต้ารับกลางทาง (Coupler Socket)

Conform to IEC60309-2

Degree of Protection	รุ่น (Model)	Pole	Color code / Earth contact position (6h)	Rated Voltage	Rated Current	Cable size (mm ²)	Packing		ราคา/ตัว (บาท)
							Pcs/Box	Pcs/Ctn	
IP44	AJ-213L	2P+E		220-240Vac (50/60Hz)	16A	1 - 2.5	10	120	140.-
	32A				2.5 - 6	10	60	200.-	
	AJ-214L	3P+E		380-415Vac (50/60Hz)	16A	1 - 2.5	10	60	160.-
	32A				2.5 - 6	10	60	220.-	
	AJ-215L				3P+N+E		220-415Vac (50/60Hz)	16A	1 - 2.5
32A	2.5 - 6	10	60	250.-					



AJ-313

AJ-314

AJ-315

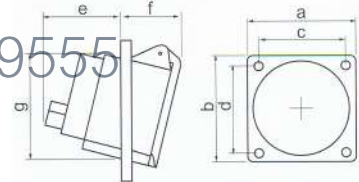

AJ-323

AJ-324

AJ-325

Earth contact position		6h					
Pole		3		4		5	
Rated current(A)		16	32	16	32	16	32
Dimension(mm.)	a	62	80	76	80	76	82
	b	68	96	80	96	86	97
	c	47	60	60	60	60	60
	d	48	70	61	70	61	70
	e	36	42	47	42	47	42
	f	37	43	37	43	37	47
	g	55	75	64	75	72	81

เต้ารับฝังผนัง (Panel Socket)

Conform to IEC60309-2

Degree of Protection	Model รุ่น	Pole	Color code / Earth contact position (6h)	Rated Voltage	Rated Current	Cable size (mm ²)	Packing		ราคา/ตัว (บาท)
							Pcs/Box	Pcs/Ctn	
IP44	AJ-313	2P+E		220-240Vac (50/60Hz)	16A	1 - 2.5	10	60	135.-
	32A				2.5 - 6	10	60	210.-	
	AJ-314	3P+E		380-415Vac (50/60Hz)	16A	1 - 2.5	10	60	160.-
	32A				2.5 - 6	10	60	230.-	
	AJ-315	3P+N+E		220-415Vac (50/60Hz)	16A	1 - 2.5	10	60	180.-
	32A				2.5 - 6	10	60	250.-	

* ราคาสินค้าไม่รวมภาษีมูลค่าเพิ่มและราคาอาจเปลี่ยนแปลงได้โดยไม่ต้องแจ้งให้ทราบล่วงหน้า *



AJ-P013



AJ-P014



AJ-P015

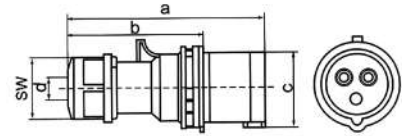

AJ-P023



AJ-P024



AJ-P025

Earth contact position	6h						
	3		4		5		
Pole	3	3	4	4	5	5	
Rated current(A)	16	32	16	32	16	32	
Dimension(mm.)	a	118	16	124	146	131	152
	b	82	100	88	100	95	106
	c	47	63	53	63	61	70
	∅	6-15	10-20	6-15	10-20	8-16	10-20
	sw	30	50	38	50	42	50

ปลั๊ก (Plugs)

Conform to IEC60309-2

Degree of Protection	รุ่น (Model)	Pole	Color code / Earth contact position (6h)	Rated Voltage	Rated Current	Cable size (mm ²)	Packing		ราคา/ตัว (บาท)
							Pcs/Box	Pcs/Ctn	
IP44	AJ-P013	2P+E		220-240Vac (50/60Hz)	16A	1 - 2.5	10	120	120.-
	AJ-P023				32A	2.5 - 6	10	60	200.-
	AJ-P014	3P+E		380-415Vac (50/60Hz)	16A	1 - 2.5	10	60	150.-
	AJ-P024				32A	2.5 - 6	10	60	235.-
	AJ-P015	3P+N+E		220-415Vac (50/60Hz)	16A	1 - 2.5	10	60	185.-
	AJ-P025				32A	2.5 - 6	10	60	255.-



AJ-S113



AJ-S114



AJ-S115

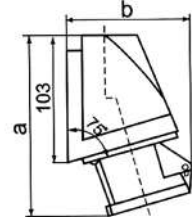
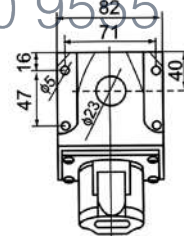

AJ-S123



AJ-S124



AJ-S125

Earth contact position	6h						
	3		4		5		
Pole	3	3	4	4	5	5	
Rated current(A)	16	32	16	32	16	32	
Dimension(mm.)	a	149	163	150	163	153	163
	b	96	107	101	107	103	113

เต้ารับลอย (Wall Socket)

Conform to IEC60309-2

Degree of Protection	รุ่น (Model)	Pole	Color code / Earth contact position (6h)	Rated Voltage	Rated Current	Cable size (mm ²)	Packing		ราคา/ตัว (บาท)
							Pcs/Box	Pcs/Ctn	
IP44	AJ-S113	2P+E		220-240Vac (50/60Hz)	16A	1 - 2.5	10	40	215.-
	AJ-S123				32A	2.5 - 6	10	40	275.-
	AJ-S114	3P+E		380-415Vac (50/60Hz)	16A	1 - 2.5	10	40	230.-
	AJ-S124				32A	2.5 - 6	10	40	295.-
	AJ-S115	3P+N+E		220-415Vac (50/60Hz)	16A	1 - 2.5	10	40	255.-
	AJ-S125				32A	2.5 - 6	10	40	330.-

* ราคาสินค้าไม่รวมภาษีมูลค่าเพิ่มและราคาอาจเปลี่ยนแปลงได้โดยไม่ต้องแจ้งให้ทราบล่วงหน้า *



AJ-C213

AJ-C214

AJ-C215

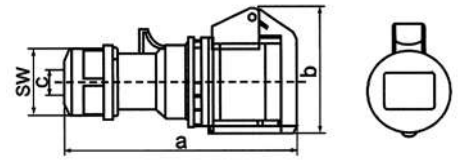

AJ-C223

AJ-C224

AJ-C225

Earth contact position		6h					
Pole		3		4		5	
Rated current(A)		16	32	16	32	16	32
Dimension(mm.)	a	127	159	135	159	142	159
	b	75	90	80	90	82	97
	c	6-15	10-20	6-15	10-20	8-16	10-20
	sw	38	50	38	50	42	50

เต้ารับกลางทาง (Coupler Socket)

Conform to IEC60309-2

Degree of Protection	รุ่น (Model)	Pole	Color code / Earth contact position (6h)	Rated Voltage	Rated Current	Cable size (mm ²)	Packing		ราคา/ตัว (บาท)
							Pcs/Box	Pcs/Ctn	
IP44 ⚠	AJ-C213	2P+E		220-240Vac (50/60Hz)	16A	1 - 2.5	10	120	170.-
	32A				2.5 - 6	10	40	225.-	
	AJ-C214	3P+E		380-415Vac (50/60Hz)	16A	1 - 2.5	10	120	170.-
	32A				2.5 - 6	10	40	240.-	
	AJ-C215	3P+N+E		220-415Vac (50/60Hz)	16A	1 - 2.5	10	60	210.-
	AJ-C225				32A	2.5 - 6	10	40	275.-



AJ-S313

AJ-S314

AJ-S315

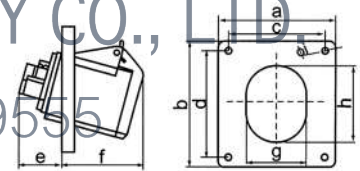

AJ-S323

AJ-S324

AJ-S325

Earth contact position		6h					
Pole		3		4		5	
Rated current(A)		16	32	16	32	16	32
Dimension(mm.)	a	80	80	80	80	80	88
	b	98	98	98	98	98	98
	c	60	60	60	60	60	60
	d	73	73	73	73	73	73
	e	37	45	40	45	43	47
	f	50	57	46	57	45	55
	g	57	72	63	72	70	78
	h	62	81	70	81	78	88
	i	5.5	5.5	5.5	5.5	5.5	5.5

เต้ารับฝั่งหน้าเฉียง (Sloping Panel Socket)

Conform to IEC60309-2

Degree of Protection	รุ่น (Model)	Pole	Color code / Earth contact position (6h)	Rated Voltage	Rated Current	Cable size (mm ²)	Packing		ราคา/ตัว (บาท)
							Pcs/Box	Pcs/Ctn	
IP44 ⚠	AJ-S313	2P+E		220-240Vac (50/60Hz)	16A	1 - 2.5	10	80	165.-
	32A				2.5 - 6	10	60	245.-	
	AJ-S314	3P+E		380-415Vac (50/60Hz)	16A	1 - 2.5	10	80	175.-
	AJ-S324				32A	2.5 - 6	10	60	250.-
	AJ-S315	3P+N+E		220-415Vac (50/60Hz)	16A	1 - 2.5	10	60	200.-
	AJ-S325				32A	2.5 - 6	10	60	275.-

* ราคาสินค้าไม่รวมภาษีมูลค่าเพิ่มและราคาอาจเปลี่ยนแปลงได้โดยไม่ต้องแจ้งให้ทราบล่วงหน้า *



AJ-S413



AJ-S414



AJ-S415

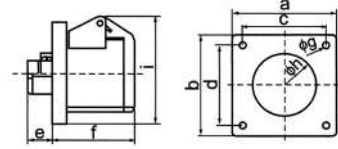

AJ-S423



AJ-S424



AJ-S425

Earth contact position		6h					
Pole		3		4		5	
Rated current(A)		16	32	16	32	16	32
Dimension(mm.)	axb	76	76	76	76	76	76
	cx d	61	61	61	61	61	61
	e	16	20	17	20	18	22
	f	60	70	60	70	58	71
	g	5.5	5.5	5.5	5.5	5.5	5.5
	h	46	61	53	61	60	62
	i	85	95	88	95	91	98

เต้ารับฝั่งหน้าตรง (Straight Panel Socket)

Conform to IEC60309-2

Degree of Protection	รุ่น (Model)	Pole	Color code / Earth contact position (6h)	Rated Voltage	Rated Current	Cable size (mm ²)	Packing		ราคา/ตัว (บาท)
							Pcs/Box	Pcs/Ctn	
IP44	AJ-S413	2P+E		220-240Vac (50/60Hz)	16A	1 - 2.5	10	80	155.-
	AJ-S423				32A	2.5 - 6	10	60	225.-
	AJ-S414	3P+E		380-415Vac (50/60Hz)	16A	1 - 2.5	10	80	170.-
	AJ-S424				32A	2.5 - 6	10	60	240.-
	AJ-S415	3P+N+E		220-415Vac (50/60Hz)	16A	1 - 2.5	10	60	195.-
	AJ-S425				32A	2.5 - 6	10	60	265.-



AJ-P513



AJ-P514



AJ-P515

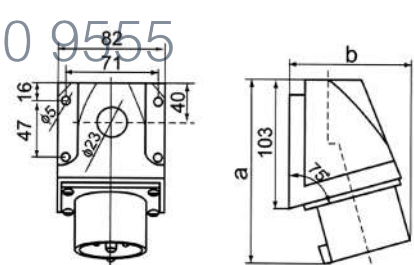

AJ-P523



AJ-P524



AJ-P525

Earth contact position		6h					
Pole		3		4		5	
Rated current(A)		16	32	16	32	16	32
Dimension(mm.)	a	130	144	135	144	135	148
	b	74	84	75	84	80	86

ปลั๊กตัวผู้ลอย (Wall Mounted Plug)

Conform to IEC60309-2

Degree of Protection	รุ่น (Model)	Pole	Color code / Earth contact position (6h)	Rated Voltage	Rated Current	Cable size (mm ²)	Packing		ราคา/ตัว (บาท)
							Pcs/Box	Pcs/Ctn	
IP44	AJ-P513	2P+E		220-240Vac (50/60Hz)	16A	1 - 2.5	10	40	175.-
	AJ-P523				32A	2.5 - 6	10	40	250.-
	AJ-P514	3P+E		380-415Vac (50/60Hz)	16A	1 - 2.5	10	40	190.-
	AJ-P524				32A	2.5 - 6	10	40	260.-
	AJ-P515	3P+N+E		220-415Vac (50/60Hz)	16A	1 - 2.5	10	40	220.-
	AJ-P525				32A	2.5 - 6	10	40	270.-

* ราคาสินค้าไม่รวมภาษีมูลค่าเพิ่มและราคาอาจเปลี่ยนแปลงได้โดยไม่ต้องแจ้งให้ทราบล่วงหน้า *



AJ-0132



AJ-0232



AJ-0332



AJ-0432



AJ-0142



AJ-0242



AJ-0342



AJ-0442



AJ-0152



AJ-0252



AJ-0352



AJ-0452

บริษัท ซีที อิเล็กทริค ซัพพลาย จำกัด
CT ELECTRIC SUPPLY CO., LTD.

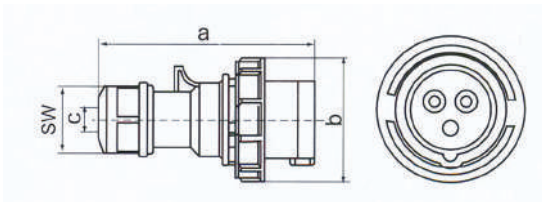

Earth contact position	6h												
	Pole 3				Pole 4				Pole 5				
Rated current(A)	16	32	63	125	16	32	63	125	16	32	63	125	
Dimension(mm.)	a	118	146	250	280	124	146	250	280	133	155	250	280
	b	43.5	57	69.5	81.5	49.5	57	69.5	81.5	56	63	69.5	81.5
	c	6-15	10-20	16-30	20-44.5	6-15	10-20	16-30	20-44.5	8-16	10-20	16-30	20-44.5
sw	38	50	63	70	38	50	60	70	42	50	60	70	

ปลั๊ก รุ่นกันน้ำ (Waterproof Plugs)

Conform to IEC60309-2

Degree of Protection	รุ่น (Model)	Pole	Color code / Earth contact position (6h)	Rated Voltage	Rated Current	Cable size (mm ²)	Packing		ราคา/ตัว (บาท)
							Pcs/Box	Pcs/Ctn	
IP67	AJ-0132	2P+E		220-240Vac (50/60Hz)	16A	1 - 2.5	10	60	160.-
	32A				2.5 - 6	10	60	250.-	
	63A				6 - 16	2	10	750.-	
	125A				16 - 50	1	10	3,000.-	
	AJ-0142	3P+E		380-415Vac (50/60Hz)	16A	1 - 2.5	10	60	185.-
	32A				2.5 - 6	10	60	280.-	
	63A				6 - 16	2	10	850.-	
	125A				16 - 50	1	10	3,100.-	
	AJ-0152	3P+N+E		220-415Vac (50/60Hz)	16A	1 - 2.5	10	60	240.-
	AJ-0252				32A	2.5 - 6	10	60	330.-
	AJ-0352				63A	6 - 16	2	10	900.-
	AJ-0452				125A	16 - 50	1	10	3,300.-

* ราคาสินค้าไม่รวมภาษีมูลค่าเพิ่มและราคาอาจเปลี่ยนแปลงได้โดยไม่ต้องแจ้งให้ทราบล่วงหน้า *



AJ-1132



AJ-1232



AJ-1332



AJ-1432



AJ-1142



AJ-1242



AJ-1342



AJ-1442



AJ-1152



AJ-1252



AJ-1352



AJ-1452

บริษัท ซีที อิเล็กทริค ซัพพลาย จำกัด
CT ELECTRIC SUPPLY CO., LTD.

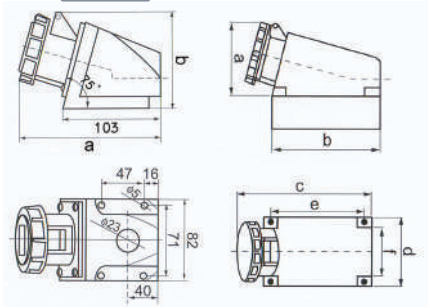

Earth contact position	6h												
	3				4				5				
Pole	16	32	63	125	16	32	63	125	16	32	63	125	
Rated current (A)	16	32	63	125	16	32	63	125	16	32	63	125	
Dimension (mm.)	a	155	170	171	220	155	155	171	220	155	172	171	220
	b	99	108	170	220	101	106	170	220	106	111	170	220
	c	-	-	250	285	-	-	250	285	-	-	250	285
	d	-	-	118	140	-	-	118	140	-	-	118	140
	e	-	-	137	185	-	-	137	185	-	-	137	185
	f	-	-	104	130	-	-	104	130	-	-	104	130

เต้ารับลอย รุ่นกันน้ำ (Waterproof Wall Socket)

Conform to IEC60309-2

Degree of Protection	รุ่น (Model)	Pole	Color code / Earth contact position (6h)	Rated Voltage	Rated Current	Cable size (mm ²)	Packing		ราคา/ตัว (บาท)
							Pcs/Box	Pcs/Ctn	
IP67 ☔	AJ-1132	2P+E		220-240Vac (50/60Hz)	16A	1 - 2.5	10	40	290.-
	AJ-1232				32A	2.5 - 6	10	40	380.-
	AJ-1332				63A	6 - 16	2	10	1,100.-
	AJ-1432				125A	16 - 50	1	10	4,100.-
	AJ-1142	3P+E		380-415Vac (50/60Hz)	16A	1 - 2.5	10	40	320.-
	AJ-1242				32A	2.5 - 6	10	40	420.-
	AJ-1342				63A	6 - 16	2	10	1,200.-
	AJ-1442				125A	16 - 50	1	10	4,200.-
	AJ-1152	3P+N+E		220-415Vac (50/60Hz)	16A	1 - 2.5	10	40	380.-
	AJ-1252				32A	2.5 - 6	10	40	480.-
	AJ-1352				63A	6 - 16	2	10	1,300.-
	AJ-1452				125A	16 - 50	1	10	4,500.-

* ราคาสินค้าไม่รวมภาษีมูลค่าเพิ่มและราคาอาจเปลี่ยนแปลงได้โดยไม่ต้องแจ้งให้ทราบล่วงหน้า *



AJ-2132



AJ-2232



AJ-2332



AJ-2432



AJ-2142



AJ-2242



AJ-2342



AJ-2442



AJ-2152



AJ-2252



AJ-2352



AJ-2452

บริษัท ซีที อิเล็กทริค ซัพพลาย จำกัด CT ELECTRIC SUPPLY CO., LTD.

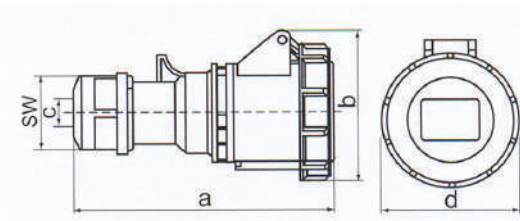

Earth contact position	6h												
	3				4				5				
Pole	16	32	63	125	16	32	63	125	16	32	63	125	
Rated current (A)	16	32	63	125	16	32	63	125	16	32	63	125	
Dimension (mm.)	a	130	163	270	300	138	163	270	300	145	168	270	300
	b	71	97	120	135	87	97	120	135	93	104	120	135
	c	6-15	10-20	16-30	20-44.5	6-15	10-20	16-30	20-44.5	8-16	12-22	16-30	20-44.5
	d	71	93	112	130	80	93	112	130	87	100	112	130
	sw	38	50	63	70	38	50	60	70	42	50	60	70

เต้ารับกลางทาง รุ่นกันน้ำ (Waterproof Coupler Socket) Conform to IEC60309-2

Degree of Protection	รุ่น (Model)	Pole	Color code / Earth contact position (6h)	Rated Voltage	Rated Current	Cable size (mm ²)	Packing		ราคา/ตัว (บาท)
							Pcs/Box	Pcs/Ctn	
IP67 ☔	AJ-2132	2P+E		220-240Vac (50/60Hz)	16A	1 - 2.5	10	60	250.-
	AJ-2232				32A	2.5 - 6	10	40	340.-
	AJ-2332				63A	6 - 16	2	10	1,050.-
	AJ-2432				125A	16 - 50	1	10	3,600.-
	AJ-2142	3P+E		380-415Vac (50/60Hz)	16A	1 - 2.5	10	60	270.-
	AJ-2242				32A	2.5 - 6	10	40	370.-
	AJ-2342				63A	6 - 16	2	10	1,150.-
	AJ-2442				125A	16 - 50	1	10	3,800.-
	AJ-2152	3P+N+E		220-415Vac (50/60Hz)	16A	1 - 2.5	10	60	300.-
	AJ-2252				32A	2.5 - 6	10	40	420.-
	AJ-2352				63A	6 - 16	2	10	1,250.-
	AJ-2452				125A	16 - 50	1	10	4,100.-

* ราคาสินค้าไม่รวมภาษีมูลค่าเพิ่มและราคาอาจเปลี่ยนแปลงได้โดยไม่ต้องแจ้งให้ทราบล่วงหน้า *

IP67
ระดับการป้องกัน



AJ-3132



AJ-3232



AJ-3333



AJ-3433



AJ-3142



AJ-3242



AJ-3343



AJ-3443



AJ-3152



AJ-3252



AJ-3353



AJ-3453

บริษัท ซีที อิเล็กทริก ซัพพลาย จำกัด

CT ELECTRIC SUPPLY CO., LTD.

Pole	Earth contact position											
	3				4				5			
Rated current (A)	16	32	63	125	16	32	63	125	16	32	63	125
a	80	80	102	122	80	80	102	122	80	88	102	122
b	98	98	114	132	98	98	114	132	98	98	114	132
c	60	60	80	101	60	60	80	101	60	60	80	101
d	73	73	92	110	73	73	92	110	73	73	92	110
e	37	45	73	92	40	45	73	92	43	47	73	92
f	52	60	83	96	50	60	83	96	47	60	83	96
g	57	72	82	94	63	72	82	94	70	78	82	94
h	62	81	90	107	70	81	90	107	78	88	90	107
i	5.5	5.5	6	6	5.5	5.5	6	6	5.5	5.5	6	6

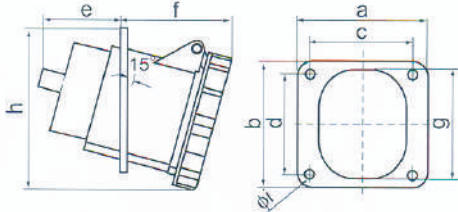

เต้ารับแผงหน้าเฉียง รุ่นกันน้ำ (Waterproof Sloping Panel Socket)							Conform to IEC60309-2		
Degree of Protection	รุ่น (Model)	Pole	Color code / Earth contact position (6h)	Rated Voltage	Rated Current	Cable size (mm ²)	Packing		ราคา/ตัว (บาท)
							Pcs/Box	Pcs/Ctn	
IP67 ☔	AJ-3132	2P+E		220-240Vac (50/60Hz)	16A	1 - 2.5	10	80	210.-
	32A				2.5 - 6	10	60	290.-	
	63A				6 - 16	2	20	820.-	
	125A				16 - 50	2	20	2,500.-	
	AJ-3142	3P+E		380-415Vac (50/60Hz)	16A	1 - 2.5	10	60	250.-
	32A				2.5 - 6	10	60	330.-	
	63A				6 - 16	2	20	920.-	
	125A				16 - 50	2	20	2,950.-	
	AJ-3152	3P+N+E		220-415Vac (50/60Hz)	16A	1 - 2.5	10	60	270.-
	AJ-3252				32A	2.5 - 6	10	60	360.-
	AJ-3353				63A	6 - 16	2	20	1,000.-
	AJ-3453				125A	16 - 50	2	20	3,100.-

* ราคาสินค้าไม่รวมภาษีมูลค่าเพิ่มและราคาอาจเปลี่ยนแปลงได้โดยไม่ต้องแจ้งให้ทราบล่วงหน้า *



AJ-4132



AJ-4232



AJ-4332



AJ-4432



AJ-4142



AJ-4242



AJ-4342



AJ-4442



AJ-4152



AJ-4252



AJ-4352



AJ-4452

บริษัท ซีที อิเล็กทริค ซัพพลาย จำกัด

CT ELECTRIC SUPPLY CO., LTD.

Earth contact position Pole	3				4				5				
	16	32	63	125	16	32	63	125	16	32	63	125	
Rated current(A)	16	32	63	125	16	32	63	125	16	32	63	125	
axb	76	76	105	120	76	76	105	120	76	76	105	120	
exd	61	61	85	100	61	61	85	100	61	61	85	100	
Dimension(mm.)	e	18	20	30	45	17	20	30	45	17	22	30	45
	f	63	74	105	104	61	74	105	104	62	73	105	104
	g	78	96	116	127	84	98	116	127	91	102	116	127
	h	46	60	75	90	53	60	75	90	60	60	75	90
	i	5	5	5.5	5.5	5.5	5.5	5.5	5.5	5.5	5.5	5.5	5.5

โทร : 02 550 9555

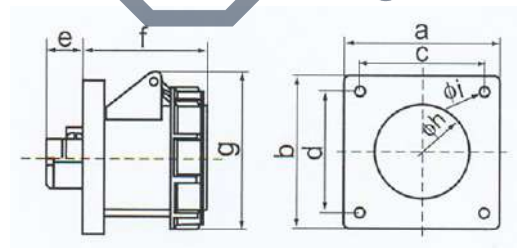

เต้ารับแผงหน้าตรง รุ่นกันน้ำ (Waterproof Straight Panel Socket) Conform to IEC60309-2

Degree of Protection	รุ่น (Model)	Pole	Color code / Earth contact position (6h)	Rated Voltage	Rated Current	Cable size (mm ²)	Packing		ราคา/ตัว (บาท)
							Pcs/Box	Pcs/Ctn	
IP67	AJ-4132	2P+E		220-240Vac (50/60Hz)	16A	1 - 2.5	10	60	210.-
	32A				2.5 - 6	10	60	290.-	
	63A				6 - 16	2	20	820.-	
	125A				16 - 50	2	20	2,500.-	
	AJ-4142	3P+E		380-415Vac (50/60Hz)	16A	1 - 2.5	10	80	250.-
	32A				2.5 - 6	10	60	330.-	
	63A				6 - 16	2	20	900.-	
	125A				16 - 50	2	20	2,950.-	
	AJ-4152	3P+N+E		220-415Vac (50/60Hz)	16A	1 - 2.5	10	80	270.-
	AJ-4252				32A	2.5 - 6	10	60	360.-
	AJ-4352				63A	6 - 16	2	20	1,000.-
	AJ-4452				125A	16 - 50	2	20	3,100.-

* ราคาสินค้าไม่รวมภาษีมูลค่าเพิ่มและราคาอาจเปลี่ยนแปลงได้โดยไม่ต้องแจ้งให้ทราบล่วงหน้า *

IP67
ระดับการป้องกัน



AJ-6132



AJ-6232



AJ-6332



AJ-6432



AJ-6142



AJ-6242



AJ-6342



AJ-6442



AJ-6152



AJ-6252



AJ-6352



AJ-6452

บริษัท ซีที อิเล็กทริก ซัพพลาย จำกัด
CT ELECTRIC SUPPLY CO., LTD.
โทร : 02-550-9555

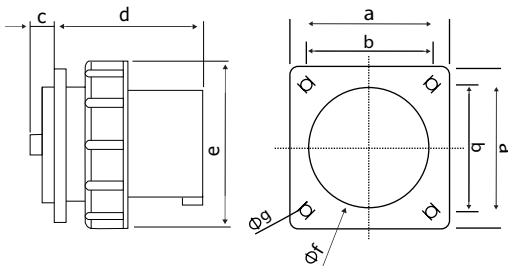

Pole	Earth contact position 6h											
	3				4				5			
Rated current (A)	16	32	63	125	16	32	63	125	16	32	63	125
a	76	76	105	120	76	76	105	120	76	76	105	120
b	61	61	85	100	61	61	85	100	61	61	85	100
c	10	10	25	25	10	10	25	25	10	10	25	25
d	63	74	91	102	61	74	91	102	74	74	91	102
e	71	93	116	124	71	93	116	124	87	100	116	124
f	46	55	75	100	46	55	75	100	55	55	75	100
g	5.5	5.5	6.5	6.5	5.5	5.5	6.5	6.5	5.5	5.5	6.5	6.5

ปลั๊กตัวผู้ฝั่ง รูนกันน้ำ (Waterproof Straight Panel Plugs) Conform to IEC60309-2

Degree of Protection	รุ่น (Model)	Pole	Color code / Earth contact position (6h)	Rated Voltage	Rated Current	Cable size (mm ²)	Packing		ราคา/ตัว (บาท)
							Pcs/Box	Pcs/Ctn	
IP67 💧	AJ-6132	2P+E		220-240Vac (50/60Hz)	16A	1 - 2.5	10	60	300.-
	AJ-6232				32A	2.5 - 6	10	60	400.-
	AJ-6332				63A	6 - 16	2	20	1,050.-
	AJ-6432				125A	16 - 50	2	20	2,750.-
	AJ-6142	3P+E		380-415Vac (50/60Hz)	16A	1 - 2.5	10	80	400.-
	AJ-6242				32A	2.5 - 6	10	60	500.-
	AJ-6342				63A	6 - 16	2	20	1,150.-
	AJ-6442				125A	16 - 50	2	20	2,900.-
	AJ-6152	3P+N+E		220-415Vac (50/60Hz)	16A	1 - 2.5	10	80	450.-
	AJ-6252				32A	2.5 - 6	10	60	550.-
	AJ-6352				63A	6 - 16	2	20	1,250.-
	AJ-6452				125A	16 - 50	2	20	3,100.-

* ราคาสินค้าไม่รวมภาษีมูลค่าเพิ่มและราคาอาจเปลี่ยนแปลงได้โดยไม่ต้องแจ้งให้ทราบล่วงหน้า *



AJ-10132-C

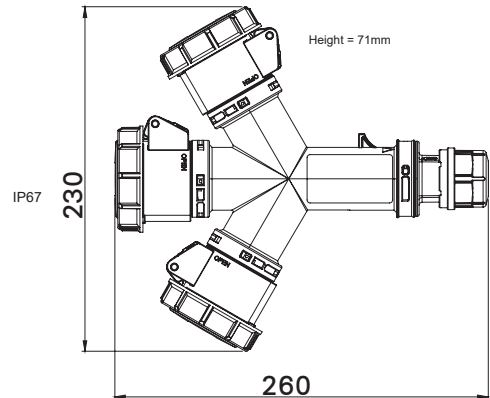

เต้ารับสามทาง รุ่นกันน้ำ (Waterproof Multiple - socket outlet)							Conform to IEC60309-2		
Degree of Protection	รุ่น (Model)	Pole	Color code / Earth contact position (6h)	Rated Voltage	Rated Current	Cable size (mm ²)	Packing		ราคา/ตัว (บาท)
							Pcs/Box	Pcs/Ctns	
IP67	AJ-10132-C (With 2m. cable)	2P+E		220-240Vac (50/60Hz)	16A	1.0 - 2.5	1	10	1,550



AJ-S1013



AJ-S1014



AJ-S1024

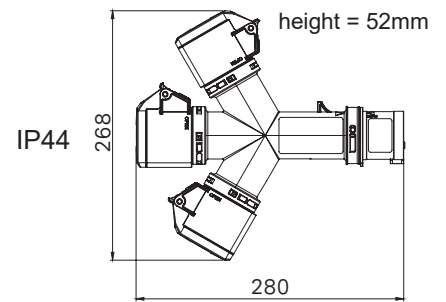
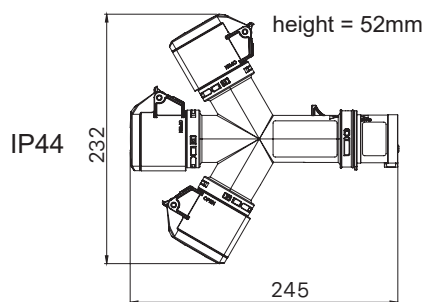
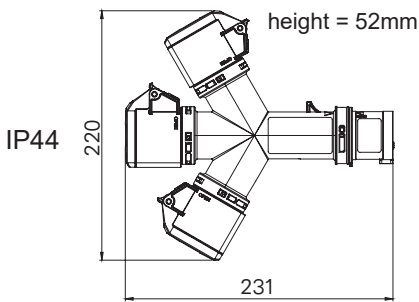

เต้ารับสามทาง (Multiple - socket outlet)							Conform to IEC60309-2		
Degree of Protection	รุ่น (Model)	Pole	Color code / Earth contact position (6h)	Rated Voltage	Rated Current	Cable size (mm ²)	Packing		ราคา/ตัว (บาท)
							Pcs/Box	Pcs/Ctns	
IP44	AJ-S1013	2P+E		220-240Vac (50/60Hz)	16A	1.0 - 2.5	2	20	900
	AJ-S1014	3P+E		380-415Vac (50/60Hz)	16A	1.0 - 2.5	2	20	1,100
	AJ-S1024	3P+E		380-415Vac (50/60Hz)	32A	2.5 - 6.0	2	20	1,500

* ราคาสินค้าไม่รวมภาษีมูลค่าเพิ่มและราคาอาจเปลี่ยนแปลงได้โดยไม่ต้องแจ้งให้ทราบล่วงหน้า *

เพิ่มความปลอดภัยในงาน Outdoor

IP44

ตู้ไฟสนามพร้อมปลั๊กเพาเวอร์ (Mobile Power Distribution Box)

Conform to IEC60439-3

รูป (Model)	Details	Quantity	ราคา (บาท)
	Socket 2P+E 32A,230V	2PCS	18,500.-
	Socket 3P+N+E 32A,400V	1PC	
	Socket 3P+N+E 63A,400V	2PCS	
	MCB 1P 32A	2PCS	
	MCB 3P 32A	1PC	
	MCB 3P 63A	2PCS	
	Socket 2P+E 16A,230V	3PCS	18,000.-
	Socket 3P+E 16A,400V	2PCS	
	Socket 3P+N+E 16A,400V	2PCS	
	MCB 1P 16A	3PCS	
	MCB 3P 32A	2PCS	
	-	-	
	Socket 2P+E 16A,230V	3PCS	17,800.-
	Socket 3P+N+E 16A,400V	3PCS	
	MCB 1P 16A	3PCS	
	MCB 3P 16A	3PCS	
	-	-	
	-	-	
	Socket 2P+E 32A,230V	2PCS	18,900.-
	Socket 3P+E 32A,400V	2PCS	
	Socket 3P+N+E 32A,400V	2PCS	
	MCB 1P 32A	2PCS	
	MCB 3P 63A	2PCS	
	-	-	

บริษัท ซีที อีเลคทริค ซัพพลาย จำกัด
CT ELECTRIC SUPPLY CO., LTD
โทร : 02 550 9555

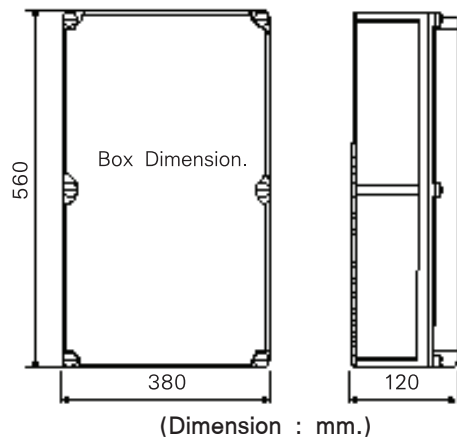

SECTION : 1

* ราคาสินค้าไม่รวมภาษีมูลค่าเพิ่มและราคาอาจเปลี่ยนแปลงได้โดยไม่ต้องแจ้งให้ทราบล่วงหน้า *