

Pten

PRICE LIST : 2014

www.tescontrol.com

Pten

บริษัท ซีที อิเล็กทริก ซัพพลาย จำกัด
CT ELECTRIC SUPPLY CO., LTD.
โทร : 02 550 9555



Fuse, Limit Switch, Meter, Power Plug, Push Button Switch Pilot Lamp,
Signal tower and many more

CONTENTS

รายการ	หน้า
อุปกรณ์วัดค่าต่าง ๆ	3
Digital Panel Meter พาเนลมิเตอร์แบบดิจิทัล	4
Analog Panel Meter พาเนลมิเตอร์ 50 X 50 mm, Hour Meter 48 mm. มิเตอร์นับชั่วโมง	5
Analog Panel Meter พาเนลมิเตอร์ 80 X 80 mm	6
Analog Panel Meter พาเนลมิเตอร์แบบอนาล็อก 96 X 96 mm	7
Current Transformer หม้อแปลงกระแสไฟฟ้า	9
Cam Operated Switch ซีล็คเตอร์สวิทช์	10
อุปกรณ์สำหรับตู้คอนโทรล	11
Control Switch คอนโทรลสวิทช์ 25, 30 มิล	12
Pilot Lamps & Accessories ไฟลัดและอุปกรณ์ 25, 30 มิล และอุปกรณ์อื่น	13
Control Switch 16 mm สวิทช์กดมีไฟและไฟลัดแบบ แอล.อี.ดี. 16 มิล	14
Control Switch Buzzer Siren สวิทช์กดลูกรัง, ไฟลัดแอมป์, ออด 16 มิล 16, 22 มิล	15
Switch & Illuminated Control Switches 22/25 mm สวิทช์กด, ลูกรัง, แอมป์ 22/25 มิล	16
Control Stations กล่องสำหรับสวิทช์กด, แอมป์ 22/25 มิล	17
Toggle Switch สแนป สวิทช์	18
Power Pushbutton Switch สวิทช์กดจม, สวิทช์กดใช้สำหรับแม่กด	20
V Micro Switch ไมโครสวิทช์ รุ่น V-15	21
TM Micro Switch ไมโครสวิทช์ รุ่น TM	23
TZ-7 Limit Switch ลิมิทสวิทช์ รุ่น TZ-7	26
TZ-8 Limit Switch ลิมิทสวิทช์ รุ่น TZ-8	29
WLD Limit Switch ลิมิทสวิทช์ รุ่น WL	32
HL Limit Switch ลิมิทสวิทช์ รุ่น HL	36
TLS Limit Switch ลิมิทสวิทช์ รุ่น TLS	38
Industrial Plugs, Sockets/Connectors/Insulated ปลั๊กพาวเวอร์ ตัวผู้และตัวเมียรุ่นใน น้ำกัน, ธรรมดา	41

สารบัญ

รายการ	หน้า
อุปกรณ์เสริม สำหรับช่างไฟฟ้า-อิเล็กทรอนิกส์	53
Accessories วายมาร์คเกอร์ชนิดร้อยสาย, ไม้ใส่สำหรับรัดสายไฟ, เต้าต่อสาย	54
Cable-Ties เข็มขัดรัดสาย	55
Accessories Cable Clamp แป้นกาว, เคเบิลแคลมป์, แป้นกาวเคเบิลแคลมป์, แป้นกาวอลูมิเนียม	56
Terminal Block เทอร์มินอลรุ่น TB และ TC	57
TBR Series Terminal Block เทอร์มินอลรุ่น TBR	60
Cassette Assembly Terminal Block เทอร์มินอลรุ่น TBC	61
Bus-Bar Insulators ลูกถ้วยบัสบาร์สีแดง	62
Step Insulators ชัฟเฟอร์ทาบันได	63
Bus-Bar Supports ฉนวนชัฟเฟอร์ทาบันได	64
Mini Warning Light, Signal Tower ไลท์เตือน, ไฟสัญญาณ, ลานเซน	66
Power Relay Socket Relay แผงเทอร์ริสเลย์, ฮอร์น	67
Timer, Moter Siren, Colling Fan Series, โทมเมอร์ริสเลย์, มินิไซเรน, มอเตอร์ไซเรน, พัดลมดูดอากาศ ระบายความร้อนสำหรับตู้คอนโทรล	68
Alarm Bell, Buzzer Bell Siren, กระดิ่ง, ออดลอย, ออดฝัง	69
Foot Switch สวิตซ์เท้าเหยียบ	70
ELECTRIC Hoist Pushbutton Cam Starter, Monolever Switch สวิตซ์เครน สวิตซ์รอกไฟฟ้ากันน้ำ, สวิตซ์โยกเดินหน้า-ถอยหลัง, สวิตซ์โยก 4 ทิศทาง	72
Fuse Base ฐานฟิวส์ สำหรับใส่ฟิวส์หลอดแก้ว และฟิวส์กระบอกรุ่น RT-18	73
D-Fuse & Cylindrical Fuse ลูกฟิวส์ รุ่น E-16, E-27 ฟิวส์กระบอกรุ่น AF-101422	74
HRC FUSE Link & Fuse Base Component ฟิวส์ลิ้งค์, ฐานฟิวส์รุ่น NH และ ด้ามดึงฟิวส์	75
สินค้าคุณภาพจาก ญี่ปุ่น	76
MEIKOSHA Plug-Sockets-Connectors อุปกรณ์ปลั๊กไฟ สำหรับงานอุตสาหกรรม 	77
Silicone Rubber Fiberglass wire สายไฟฟ้าทนความร้อน (ใยแก้วหุ้มยาง) 	81
Contact Cleaner, Ac Solinoids สเปร์ยล้างคอนแทค และโซลินอยด์กิโล 	82
Hi-Speed Carbide Holesaw ดอกเจาะรูกลม สำหรับเจาะสแตนเลส, เหล็ก 	83
Cooper ปลั๊ก, เต้ารับ, สวิตซ์, ฝา, ปลั๊กอุตสาหกรรม 	85

บริษัท ซีที อีเลคทริก ซัพพลาย จำกัด
CT ELECTRIC SUPPLY CO., LTD.
 โทร : 02 550 9555

Accuracy and Stability

อุปกรณ์วัดค่าต่าง ๆ
และปรับแรงดันของระบบไฟฟ้า

วัดค่าได้ถูกต้องและเสถียร



บริษัท ซีที อิเล็กทริค ซัพพลาย จำกัด
CT ELECTRIC SUPPLY CO., LTD.
โทร : 02-550 9555



วัดกระแสไฟ วัดแรงดัน วัดพลังงาน
วัดค่าความถี่ วัดค่าความเสถียร

Digital Panel Meter

พานลมิเตอร์แบบดิจิทัล

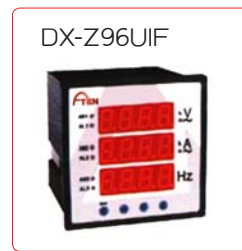

CT operated AC Ammeter (แอมป์ดิจิทัล)

รุ่น (Model)	Frame Size (mm)	Mode	Display Range	Class Index	Case Qty. (Pcs)	Item Code	ราคา (฿)
DX-A96	96x96	x/5A*	0-9999A	0.5	36	4890000	1,200.-
DX-A72	72x72	x/5A*	0-9999A	0.5	36	4870000	1,200.-

Direct input AC Voltmeter (โวลต์ดิจิทัล)

DX-V96	96x96	-	0-600V	0.5	36	5096000	1,200.-
DX-V72	72x72	-	0-600V	0.5	36	5072000	1,200.-

Frequency Meter (ไซเทิลมิเตอร์วัดความถี่)

DX-F96	96x96	-	30-100.0Hz	0.5	36	4596000	1,280.-
DX-F72	72x72	-	30-100.0Hz	0.5	36	4572000	1,280.-

Digital Power Factor Meter (ดิจิทัลคอสไมเตอร์)

DX-PF96S	96x96	1P	LO-1.0-C0	0.5	36	4691000	3,800
DX-PF72S	72x72	1P	LO-1.0-C0	0.5	36	4671000	3,800

Digital Watt Meter (ดิจิทัลวัตต์มิเตอร์)

DX-P96S	96x96	1P	0-9999*	0.5	36	4791000	3,800
DX-P72S	72x72	1P	0-9999*	0.5	36	4771000	3,800

Digital Panel Meter ดิจิตอลพานลมิเตอร์ DP3-96 (3 Display)

DX-Z96I3	96x96	x/5A	0-9999A	0.5	36	5290000	3,000
DX-Z96U3	96x96	-	0-600V	0.5	36	5396000	3,000
DX-Z96UIF	96x96	-	-	0.5	36	5496000	3,500
DX-Z96UIP	96x96	-	-	0.5	36	5596000	5,800

Analog Panel Meter

พานลมิเตอร์ 50 X 50 mm
DE-50 Series Moving Iron Type

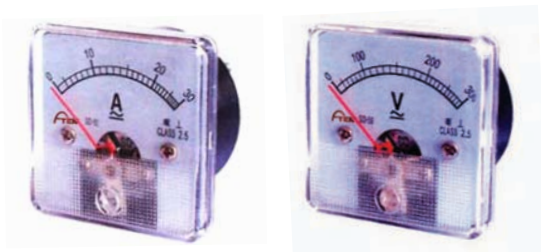

Connection Diagram

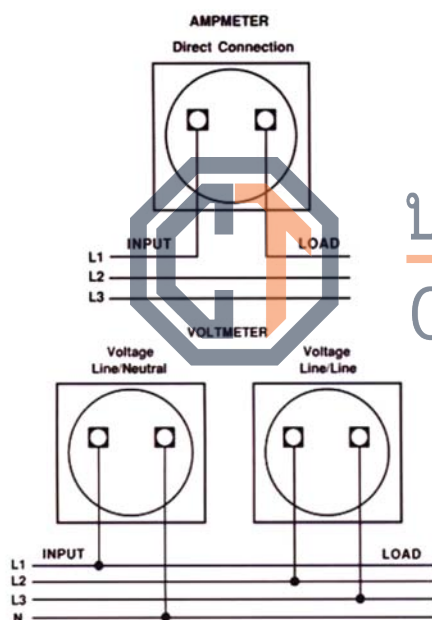

Specifications :

- Accuracy Class : 2.5
- Rated Voltage : 600Vac
- Rated Temperature : 10..45°C
- Insulation Test : 2KV, 50Hz, 1min

แอมป์มิเตอร์ (Amp Meter)

รุ่น (Model)	Connection	Measurin Range	ราคา (฿)
DE-DA50	Direct Connection (ต่อตรง)	5A, 10A, 15A, 20A, 30A,	140 .-

โวลต์มิเตอร์ (Volt Meter)

รุ่น (Model)	Voltage Range	ราคา (฿)
DE-V50	0-300V, 0-500V	150 .-

บริษัท ซีที อีเล็คทริก ซัพพลาย จำกัด

CT ELECTRIC SUPPLY CO., LTD

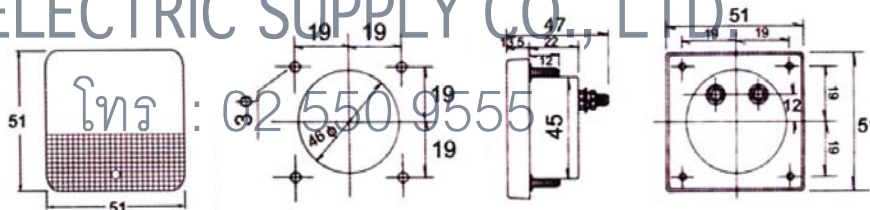

Hour Meter

มิเตอร์นับชั่วโมง



มิเตอร์นับชั่วโมง 48 (Hour Meter 48 mm)

รุ่น (Model)	Voltage	Power Consumption	Display	ราคา (฿)
DE-H48	220-240 Vac	2.5 VA	99999.99 H	450 .-

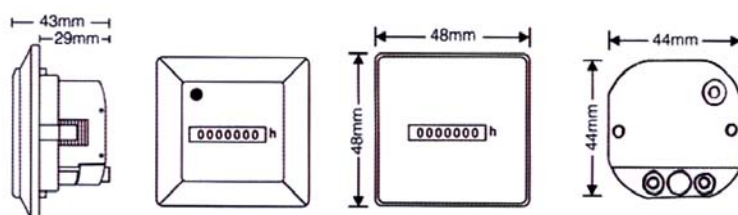

Analog Panel Meter

พานลมิเตอร์ 80 X 80 mm

DE-80 Series Moving Iron Type

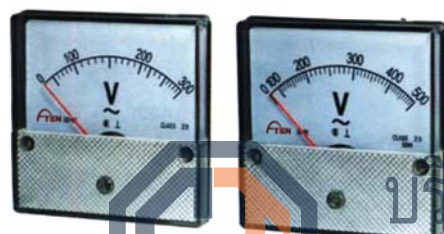

Specifications :

- Accuracy Class : IEC 185
- Rated Voltage : 600Vac
- Rated Temperature : 10..45°C
- Insulation Test : 2KV, 50Hz, 1min

แอมป์มิเตอร์ (Amp Meter)

รุ่น (Model)	Connection	Measurin Range	ราคา (฿)
DE-80 A	Direct Connect (ต่อตรง)	5A, 10A, 15A, 20A, 30A, 40A, 50A, 60A,	170 .-
DE-80 A	For CT x/5A (ผ่าน CT)	20/5A, 30/5A, 50/5A, 60/5A, 100/5A	170 .-

โวลต์มิเตอร์ (Volt Meter)

รุ่น (Model)	Measuring Range	ราคา (฿)
DE-80 V	0-300V, 0-500V	170 .-

Connection Diagram

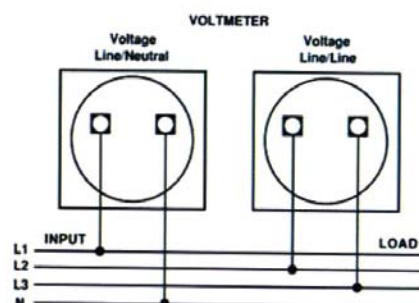
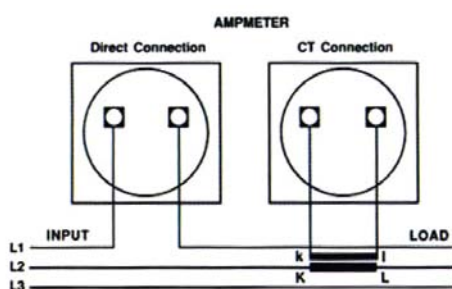

Panel Cut-Out

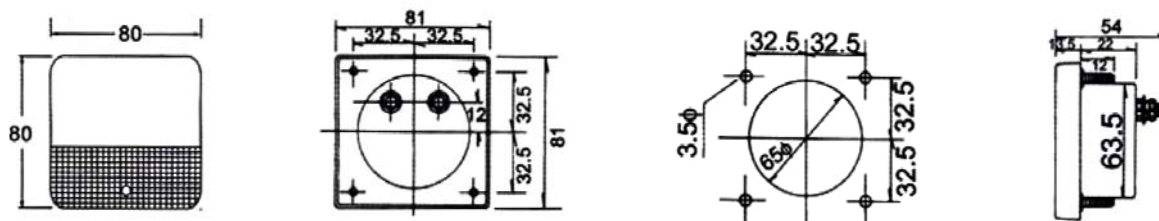

Analog Panel Meter

พานนมิตอร์แบบอนาล็อก 96 X 96 mm

DE-96 Series Moving Iron Type Meter



DE-96A



DE-96V

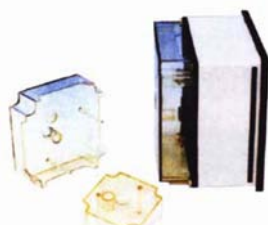

Connection Diagram

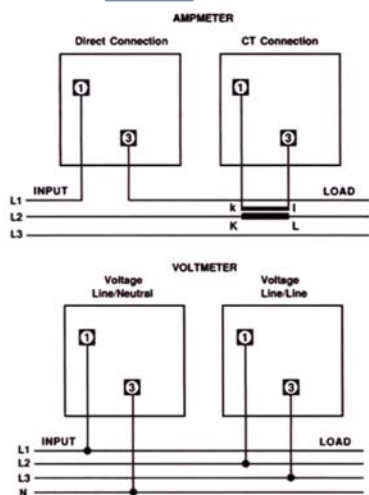

Panel Cut-Out

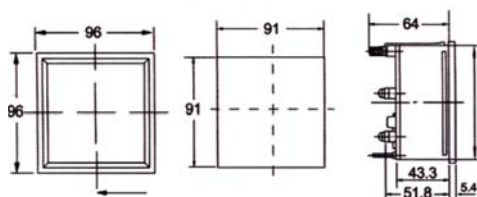

แอมป์มิเตอร์ (Amp Meter)

รุ่น (Model)	Connection	Measurin Range	ราคา (฿)
DE-96A	Direct Connection (ต่อตรง)	20A, 30A, 50A, 60A, 80A, 100A	320 .-
DE-96 A	Connect with CT X/5A (ต่อผ่าน CT)	20/5, 30/5A, 50/5A, 60/5A, 80/5A, 100/5A, 150/5A, 200/5A, 250/5A, 300/5A, 400/5A, 500/5A, 600/5A, 800/5A, 1000/5A, 1200/5A, 1500/5A, 2000/5A, 2500/5A, 3000/5A,	300 .-

โวลต์มิเตอร์ (Vole Meter)

รุ่น (Model)	Connection	Measurin Range	ราคา (฿)
DE-96 V	Direct Connection	0-300V, 0-500V	320 .-

Operation Conditions :

Ambient Temperature Limits	Reference temperature+20°C
Rated temperature Thresholds	10, 30°C -25°C/40°C
Current frequency	45, 50..55Hz
Insulation test	2KV, LTD.
Protection grade	IP54, IP55
Angular scale	90° degree
Input Voltage (Over Loads)	
- Voltage	x 1.5 Un Permanently x 2.0 Un During 5 Sec.
- Current	x 1.2 In Permanently. x 5.0 In During 30 Sec. x 10 In During 5 Sec. x 40 In During 1 Sec.
Power Consumption	1.8VA for 250V 3.3VA for 300V
- Voltage from 1 to 4 VA	
- Current from 0.3 to 1.5 VA	0.7VA for 1A 1.2VA for 5A

Operation Conditions :

Accuracy Class	1.5
IEC regulation	IEC51, IEC 144
DIN standard	
- Case dimension	DIN 43700
- Scale Marking	DIN 43802
- Magnetic influence	DIN 43780
Housing	Self-Extinguishing PolymerABC, According to UL94
Front frame	RAL 7037, GB 7676-1998

Analog Panel Meter

พานนมิตอร์แบบอนาล็อก 96 X 96 mm

DE-96 Series Moving Iron Type

Specifications :

- Protection Degree : IP 50
- Case Material : Thermoplastic/glass



DE-F96 แบบเข็ม



DE-R96 แบบสั้น



DE-PF96 Power Factor

มิเตอร์วัดความถี่ (Frequency Meter)

รุ่น (Model)	Type	Accuracy Class	Input Voltage	Measurin Range	ราคา (฿)
DE-F96	แบบเข็ม	1.0	220V, 380V	45...55 Hz, 45...65 Hz	950 .-
DE-R96	แบบสั้น	1.5	220V, 380V	45...55 Hz, 45...65 Hz	950 .-

เพาเวอร์ แฟกเตอร์ (Power Factor Meter)

รุ่น (Model)	Input Voltage	Accuracy Class	Active	Input Current	Measuring Range	ราคา (฿)
DE-PF96	220V	2.5	1P	5A	Cap 0.5...1...0...0.5 IND	1,700 .-
DE-PF96	380V	2.5	3P, 4W	5A	Cap 0.5...1...0...0.5 IND	1,700 .-

Operation Conditions :

Current frequency	45..50..55Hz
Ambient Temp Limits	10..23..30°C
Thresholds	-25°C to 40°C
Relative air humidity	25..85%
Mounting Angle	90° degree
Input Voltage (Over Loads)	x 1.5 In Permanently.
- Voltage	x 2.0 In During 5 sec.
- Current	x 1.2 In Permanently.
	x 5.0 In During 30 sec.
	x 10 In During 5 sec.
	x 40 In During 1 sec.

Standards :

IEC regulation	IEC51, IEC473
DIN standard	
- Case dimension	DIN 43700
- Scale Marking	DIN 43802
- Magnetic influence	DIN 43780
Housing	Self-Extinguishing Polymer ABS,
	According to UL94
Front frame	RAL 7037, GB 7676-1998

Connection Diagram

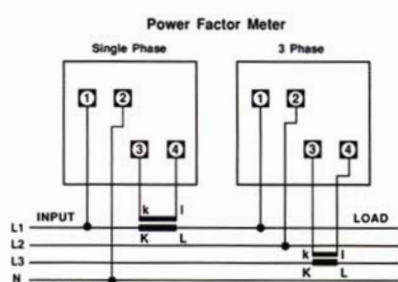
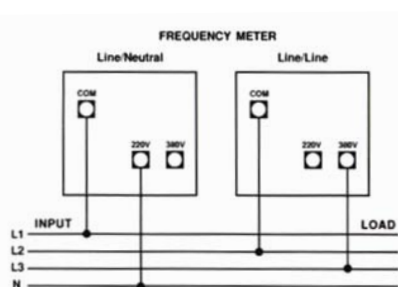

Panel Cut-Out

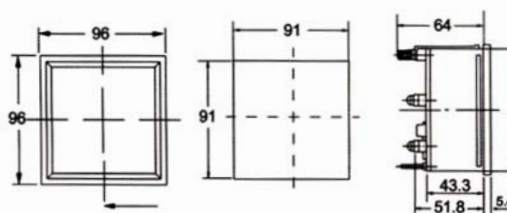

Current Transformer หม้อแปลงกระแสไฟฟ้า



Specifications :

- Standard : IEC 185
- Rated Temperature : 10..45°C
- Class : 1.0
- Rated Voltage : 600Vac
- Operating Frequency : 50/60 Hz
- Case : ABS Plastic Case

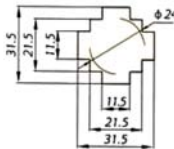
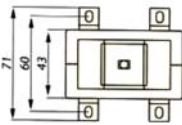
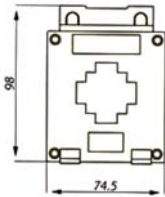

MSQ-30

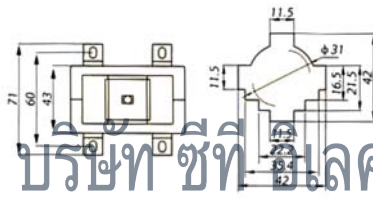
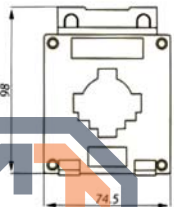

MSQ-40

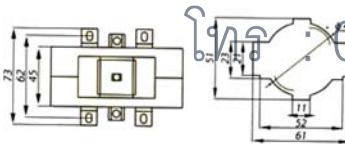
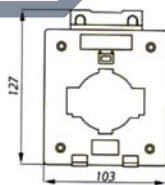

MSQ-60

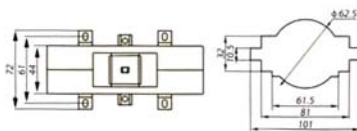
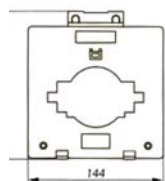

MSQ-100

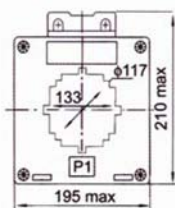

MSQ-125

MSQ-Series

Class 1.0

รุ่น (Model)	Window	Related Load	Rated Current	ราคา (฿)	ราคา (฿) รุ่นตู้
MSQ-30	30x20 mm.	1.5 VA	30/5 A	220 .-	180 .-
		1.5 VA	40/5 A		
		2.5 VA	50/5 A		
		2.5 VA	60/5 A		
		1.5 VA	100/5 A		
MSQ-40	41x10 mm.	2.5 VA	150/5 A	220 .-	N/A
		5 VA	200/5 A		
		5 VA	250/5 A		
		5 VA	300/5 A		
		10 VA	400/5 A		
MSQ-60	60x20 mm.	10 VA	400/5 A	360 .-	N/A
			500/5 A		
			600/5 A		
			800/5 A		
MSQ-100	100x30 mm.	15 VA	1000/5 A	510 .-	N/A
			1200/5 A	550 .-	N/A
			1500/5 A	610 .-	N/A
			2000/5 A	760 .-	N/A
			2500/5 A	990 .-	N/A
			3000/5 A	1,200 .-	N/A
MSQ-125	130x10 mm.	20 VA	2000/5 A	900 .-	N/A
			2500/5 A	1,230 .-	N/A
			3000/5 A	1,360 .-	N/A
			4000/5 A	1,600 .-	N/A
			5000/5 A	1,990 .-	N/A

บริษัท ซีที อิเล็กทริก ซัพพลาย จำกัด
 CT ELECTRIC SUPPLY CO., LTD.
 โทร 02 550 9555

Selector Switch

แอมป์มิเตอร์สวิตช์, โวลท์มิเตอร์สวิตช์



Specifications :

- Front Protection : IP65
- Operation Temperature : -25°C to 55°C
- Rated Uninterruption Current : 20A
- Rated Operation Current : 16A
- Frequency : UP to 10KHz
- Duty Rating : 60% /40% / 25%E.D.:1.3/1.6/2.0
- Max.life : up to 3 million switching operations
- Max.switching Cycle : 300 operations/hour
- Contacts : Double break type Ag/AgNiAgCdO
- Standard : DIN57-660/1/DE0660

แอมป์มิเตอร์สวิตช์ (Ammeter Switch)

รุ่น (Model)	Plate Size (mm.)	AC1 @ 380V	Color Body	Color Plate	ราคา (฿)
DW26-20/3+AK001 OFF-1-2-3	48x60	20 A	Blue	Silver	260 .-
DW26-20/3+AK001 O-R-S-T		20 A	Blue	Silver	
SA16-4-3	48x60	16 A	Black	Yellow	430 .-
SA16-4-3	64x80	16 A	Black	Yellow	450 .-

โวลท์มิเตอร์สวิตช์ (Voltmeter Switch)

รุ่น (Model)	Plate Size (mm.)	AC1 @ 380V	Color Body	Color Plate	ราคา (฿)
DW26-20+VN001 O-RS-ST-TR	48x60	20 A	Blue	Silver	260 .-
DW26-20/3+VN002 RS-ST-TR-O-RN-SN-TN		20 A	Blue	Silver	
SA16-7-3	48x60	16 A	Black	Yellow	430 .-
SA16-7-3	64x80	16 A	Black	Yellow	450 .-

บริษัท ซีที อิเล็กทริค ซัพพลาย จำกัด

CT ELECTRIC SUPPLY CO., LTD.

Changover Switch

แชนจ์โอเวอร์สวิตช์

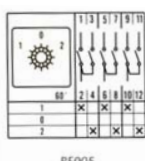
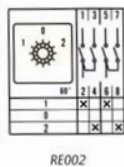

แชนจ์โอเวอร์สวิตช์ ON-OFF

รุ่น (Model)	Plate Size (mm.)	ราคาตัวละ (฿)	
DW26-10/2+RE002	10 A	47x47	340 .-
DW26-20/2+RE002	20 A	47x47	300 .-

แชนจ์โอเวอร์สวิตช์ ON-OFF-ON

รุ่น (Model)	Plate Size (mm.)	ราคาตัวละ (฿)	
DW26-10/3+RE005	10 A	47x47	450 .-
DW26-20/3+RE005	20 A	47x47	340 .-

Rotary Switch

โรตารีสวิตช์

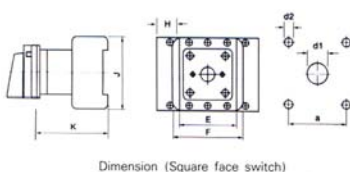

Dimension (Square face switch)

Specifications :

- Made of industrial grade thermoplastic ABS
- IEC 60947-3, IEC 52916, GB/T 14048.3 IP20
- Able to withstand a temperature range from -5°C to +40°C
- Chemical resistance to aqueous acids, alkalis, salt & sea water. Concentrated phosphoric & hydrochloric acids have little effect on ABS

DW Series with Padlock IP20

รุ่น (Model)	Pole	Rated Current	Size (mm.)	ราคา (฿)
DW26GS-25/2+NF004	3P	25A	48x60	800 .-
DW26GS-32/2+NF004	3P	32A	48x60	950 .-
DW26GS-63/2+NF004	3P	63A	48x60	1,500 .-

Most Complete brand

For All Distribution Board.



บริษัท ซีที อีเล็คทริค ซัพพลาย จำกัด

CT ELECTRIC SUPPLY CO., LTD.

โทร 02-550-9155



อุปกรณ์ไฟฟ้า - อิเล็กทรอนิกส์

ครบวงจรสำหรับตู้คอนโทรล

Illuminated P.B. Sw. Ø 25/30 mm.

อัลลูมินัม พุชบัทก่อน สวิตซ์ Ø 25/30 มม.

NPB25

220V

สวิตซ์กดหัวนูน
มีไฟลัดแลมป์ 25 มม.

Color : เขียว, แดง, เหลือง, ขาว

➡ Price 140 .-



NPB30

220V

สวิตซ์กดหัวนูน
มีไฟลัดแลมป์ 30 มม.

Color : เขียว, แดง, เหลือง, ขาว

➡ Price 160 .-



Push Button Switch Ø 25/30 mm.

พุชบัทก่อน สวิตซ์ Ø 25/30 มม.

EPB251
EPB301

MB251
MB301



OB251
OB301

RB251
RB301



Type No. (รุ่น)	รายละเอียด	Color สี	ราคาตัวละ (฿)
EPB251 (Ø 25 mm.) EPB301 (Ø 30 mm.)	สวิตซ์กดหัวเรียบ	เขียว, เหลือง, ดำ, แดง	55 .- 65 .-
MB251 (Ø 25 mm.) MB301 (Ø 30 mm.)	สวิตซ์กดหัวเห็ด	เขียว, เหลือง, แดง	65 .- 75 .-
OB251 (Ø 25 mm.) OB301 (Ø 30 mm.)	สวิตซ์กดหัวนูน 25 มม. สวิตซ์กดหัวนูน 30 มม.	เขียว, เหลือง, ดำ, แดง	60 .- 70 .-
RB251 (Ø 25 mm.) RB301 (Ø 30 mm.)	สวิตซ์กดลัดหัวเห็ด	เขียว, แดง	150 .- 160 .-

Selector (Key) Switch Ø 25/30 mm.

ซีล็คเตอร์ (คีย์) สวิตซ์ Ø 25/30 มม.

สวิตซ์ลูกศร 25 มม.

SS25/2P

SS25/3P

Color : เขียว, แดง, ดำ

➡ Price 70 .-



สวิตซ์ลูกศรแบบก้านยาว 25 มม.

LS25/2

LS25/3

Color : ดำ

➡ Price 75 .-



สวิตซ์ลูกศร 30 มม.

SS30/2P

SS30/3P

Color : เขียว, แดง, ดำ

➡ Price 80 .-



สวิตซ์ลูกศรแบบก้านยาว 30 มม.

LS30/2

LS30/3

Color : ดำ

➡ Price 90 .-



Neon Lamp

นีออน แลมป์



Type No. (รุ่น)	รายละเอียด	Color สี	ราคาตัวละ (฿)
EFN 10	220 VAC (Ø 10 mm.)	แดง, เขียว, เหลือง, น้ำเงิน, ขาว	22 .-
EFN 16	6V-220VAC (Ø 14 mm.)		60 .-
EFRN 10	220 VAC (Ø 10 mm.)		22 .-
EFUN 12	220VAC (Ø 12 mm.)		50 .-

Pilot Lamp Ø 22/25/30 mm.

ไฟลีดแลมป์ Ø 22/25/30 มม.

N2-LR AC 220V
ไฟลีดแลมป์ต่อตรง 22/25 มม.
Color : เขียว, แดง, เหลือง,
น้ำเงิน, ขาว
➡ Price 90 .-

KPR25 ไฟลีดแลมป์ รุ่นหัวกลม 25 มม.
220V ➡ Price 85 .-
380V ➡ Price 90 .-
Color : เขียว, แดง, เหลือง,
น้ำเงิน, ขาว

KPR30 ไฟลีดแลมป์ รุ่นหัวกลม 30 มม.
220V ➡ Price 110 .-
380V ➡ Price 115 .-
Color : เขียว, แดง, เหลือง,
น้ำเงิน, ขาว

ERN-25 AC/DC 24V
ไฟลีดแลมป์ รุ่นหัวกลม 25 มม.
Color : เขียว, แดง, เหลือง,
น้ำเงิน, ขาว
➡ Price 50 .-

ERN30 AC 220V
ไฟลีดแลมป์ รุ่นหัวกลม 30 มม.
Color : เขียว, แดง, เหลือง,
น้ำเงิน, ขาว
➡ Price 60 .-

ไส้หลอด (25 mm)

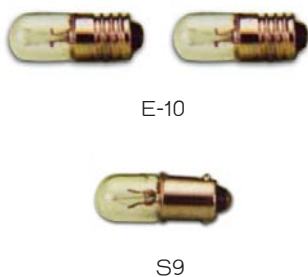

Bulb Typev E-10, S9			
Type No. (รุ่น)	รายละเอียด	Color สี	ราคาตัวละ (฿)
E-10	6.3 V, 24 V	-	12 .-
	110 V	R, G	17 .-
	220 V	R, G	21 .-
S9	110 V	-	15 .-
	220 V	-	
	380 V	-	

Push Button Switch

Illuminated Pushbuttons & Pilot Light (LED)

สวิตช์กดมีไฟและไฟลัดแอมป์ แบบ แอล.อี.ดี



สวิตช์กดมีไฟ และ ไฟลัดแอมป์ ชนิดหัวกลม (Round Type)

Type no. (รุ่น)	Operation Type แบบ	Rated Voltage ขนาดโวลต์ (V.)	Color สี	ราคาตัวละ (฿)
LA16Y-11	Momentary	ไม่มีไฟ AC 220	แดง, เขียว,	150 .-
LA16Y-11D	แบบกดไม่ล๊อค	มีไฟ AC 220	เหลือง, น้ำเงิน, ขาว	200 .-
LA16Y-11S	Alternate	ไม่มีไฟ AC 220	แดง, เขียว,	160 .-
LA16Y-11DS	แบบกดล๊อค	มีไฟ AC 220	เหลือง, น้ำเงิน, ขาว	210 .-
LA16Y-XD	Pilot Light ไฟลัดแอมป์	AC/DC24V AC 220	แดง, เขียว, เหลือง, น้ำเงิน, ขาว	110 .-



สวิตช์กดมีไฟ และ ไฟลัดแอมป์ ชนิดหัวสี่เหลี่ยมจัตุรัสเล็ก (Square Type)

Type no. (รุ่น)	Operation Type แบบ	Rated Voltage ขนาดโวลต์ (V.)	Color สี	ราคาตัวละ (฿)
LA16Z-11	Momentary	ไม่มีไฟ AC 220	แดง, เขียว,	150 .-
LA16Z-11D	แบบกดไม่ล๊อค	มีไฟ AC 220	เหลือง, น้ำเงิน, ขาว	200 .-
LA16Z-11S	Alternate	ไม่มีไฟ AC 220	แดง, เขียว,	160 .-
LA16Z-11DS	แบบกดล๊อค	มีไฟ AC 220	เหลือง, น้ำเงิน, ขาว	210 .-
LA16Z-XD	Pilot Light ไฟลัดแอมป์	AC/DC24V AC 220	แดง, เขียว, เหลือง, น้ำเงิน, ขาว	110 .-

สวิตช์กดมีไฟ และ ไฟลัดแอมป์ ชนิดหัวสี่เหลี่ยมผืนผ้าใหญ่ (Rectangular Type)

Type no. (รุ่น)	Operation Type แบบ	Rated Voltage ขนาดโวลต์ (V.)	Color สี	ราคาตัวละ (฿)
LA16J-11	Momentary	ไม่มีไฟ AC 220	แดง, เขียว,	150 .-
LA16J-11D	แบบกดไม่ล๊อค	มีไฟ AC 220	เหลือง, น้ำเงิน, ขาว	200 .-
LA16J-11S	Alternate	ไม่มีไฟ AC 220	แดง, เขียว,	160 .-
LA16J-11DS	แบบกดล๊อค	มีไฟ AC 220	เหลือง, น้ำเงิน, ขาว	210 .-
LA16J-XD	Pilot Light ไฟลัดแอมป์	AC/DC24V AC 220V	แดง, เขียว, เหลือง, น้ำเงิน, ขาว	110 .-

สวิตช์หัวเห็น 16 มิล



LA16Y-11M - R, G, Y

➡ Price 250 .-

LA16Y-11MD R, G, Y

➡ Price 280 .-



ถอด 16 มิล

AB-16-22SM-C
DC24V

➡ Price 350 .-

สวิตช์หัวเห็นกดล๊อค 16 มิล



LA16Y-11ZS - R, G, Y

➡ Price 350 .-



ถอด 16 มิล

AB-16-22SM-R
DC24V

➡ Price 350 .-

Push Button Switch

Selector Switches Ø 16 mm.

สวิตช์กดลูกศร Ø 16 mm.



สวิตช์ลูกศร ชนิดหัวกลม (Round Type) Ø 16 mm.

Type no. (รุ่น)	Contact คอนแทก	Color สี	ราคาตัวละ (฿)
LA16Y-11x2P	1A 1B แบบ 2 จังหวะ	ดำ	290 .-
LA16Y-22x3P	2A แบบ 3 จังหวะ	ดำ	290 .-

สวิตช์ลูกศร ชนิดหัวสี่เหลี่ยมจัตุรัสเล็ก (Square Type) Ø 16 mm.

Type no. (รุ่น)	Contact คอนแทก	Color สี	ราคาตัวละ (฿)
LA16Z-11x2P	1A 1B แบบ 2 จังหวะ	ดำ	290 .-
LA16Z-22x3P	2A แบบ 3 จังหวะ	ดำ	290 .-

สวิตช์ลูกศร ชนิดหัวสี่เหลี่ยมผืนผ้าใหญ่ (Rectangular Type) Ø 16 mm.

Type no. (รุ่น)	Contact คอนแทก	Color สี	ราคาตัวละ (฿)
LA16J-11x2P	1A 1B แบบ 2 จังหวะ	ดำ	290 .-
LA16J-22x3P	2A แบบ 3 จังหวะ	ดำ	290 .-

บริษัท ซีที อีเล็คทริค ซัพพลาย จำกัด
CT ELECTRIC SUPPLY CO., LTD.

โทร : 02 550 9555

Led Lamp & Buzzer

ไฟลีดอแลมป์, ออด



AD16-22D/S



AD-16-22SM



AD-16-FMB

ไฟลีดอแลมป์ แบบ แอล.อี.ดี. LED LAMP 22 มิล

Type no. (รุ่น)	Color สี	Rated Voltage ขนาดโวลต์ (V.)	Contact คอนแทก	ราคาตัวละ (฿)
AD16-22D/S	แดง, เขียว, เหลือง, น้ำเงิน, ขาว	AC/DC24 AC 110V, AC 220V	10 PCS.	50 .-

ไฟลีดอแลมป์ แบบ แอล.อี.ดี. LED LAMP, Buzzer

Type no. (รุ่น)	Color สี	Rated Voltage ขนาดโวลต์ (V.)	Contact คอนแทก	ราคาตัวละ (฿)
AD-16-22SM	แดง	AC/DC24	10 PCS.	140 .-
AD-16-FMB	ดำ	AC 220V		150 .-

ST-70AB



Price 280 .-

สวิตช์ควบคุมระดับน้ำชนิด 2 ลูกตุ้ม

- มีด้ายหลอด (thread) ขนาด 1 หรือ 3/4 พร้อมกับตัว L-bracket เพื่อให้ง่ายในการติดตั้ง และมีท่อน 2 ท่อน เพื่อช่วยในการควบคุมให้มีความแน่นอนมากยิ่งขึ้น
- Power : 110/220V, 1HP Contact A and B Single throw.

Push Button Switch

Model Designation



<p>สวิทช์ กดหัวเรียบ</p>  <p>LAY37T-01 BN R LAY37T-1 OBN G, Y, W, B</p> <p>➡ Price 110 .-</p>	<p>สวิทช์ กด เปิด-ปิด</p>  <p>LAY37T-11SJ</p> <p>➡ Price 280 .-</p>
<p>สวิทช์กดหัวนูน</p>  <p>LAY37T-01 GN R LAY37T-1 OGN G, Y</p> <p>➡ Price 125 .-</p>	<p>สวิทช์ กด เปิด-ปิด มีไฟ</p>  <p>LAY37T-11SJD AC 220V</p> <p>➡ Price 400 .-</p>
<p>สวิทช์กดหัวเห็ด</p>  <p>LAY37T-01 MN R LAY37T-1 OMN G, Y</p> <p>➡ Price 130 .-</p>	<p>สวิทช์ กด หัวเรียบ มีไฟ</p>  <p>LAY37T-01DP R LAY37T-10DP G, Y, W, BL AC 220V</p> <p>➡ Price 250 .-</p>
<p>สวิทช์กดจมหัวนูน</p>  <p>LAY37T-11 GNZS R, G, Y</p> <p>➡ Price 200 .-</p>	<p>สวิทช์ กด หัวนูน มีไฟ</p>  <p>LAY37T- 01D R LAY37T- 10D G, Y AC 220V</p> <p>➡ Price 260 .-</p>
<p>สวิทช์กดลือคหัวเห็ด</p>  <p>LAY37T-01 ZS R</p> <p>➡ Price 190 .-</p>	<p>สวิทช์กดลือคหัวเห็ด มีไฟ</p>  <p>LAY37T- 01DM R LAY37T- 10DM G, Y AC 220V</p> <p>➡ Price 290 .-</p>
<p>สวิทช์ลูกศร 2 จังหวะ: สวิทช์ลูกศร 3 จังหวะ:</p>  <p>LAY37T-11X/2 LAY37T-20X/3 Color : R, G, Y, B</p> <p>➡ Price 160 .-</p>	<p>สวิทช์ลูกศรก้านยาว 2 จังหวะ: สวิทช์ลูกศรก้านยาว 3 จังหวะ:</p>  <p>LAY37T- 11XB/2 B LAY37T- 20XB/3 B Color : B</p> <p>➡ Price 170 .-</p>

Push Button Switch

Model Designation



สวิตช์ลูกศรมีไฟ 2 จังหวะ: LAY37T-11XD/2

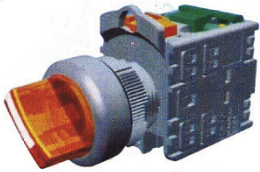

สวิตช์ลูกศรมีไฟ 3 จังหวะ:
LAY37T-20XD/3 AC 220V
Color : R, G, Y

➔ Price 260 .-

สวิตช์กุญแจ 2 จังหวะ: LAY37T-11Y/2

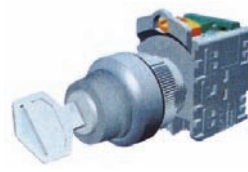

สวิตช์กุญแจ 3 จังหวะ:
LAY37T-20Y/3

➔ Price 410 .-



Contact Block
NO LAY37T-1A-NO
NC LAY37T-1B-NC

➔ Price 70 .-

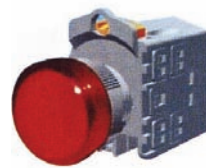

ไฟลัดตามป์
LAY37T-XD
Color : R, G, Y, W, BL

➔ Price 145 .-

Control Stations

คอนโทรลสเตชัน Ø 22 มม.

บริษัท ซีที อิเล็กทริก ซัพพลาย จำกัด

LAY5-JB0x1	LAY5-JB0x2	LAY5-JB0x3	Control Box		LAY5 - Series
			รุ่น (Model)	รายละเอียด (Details)	จำนวนช่อง ราคา (฿)
			LAY5-JB0x1	light grey - Base, yellow - lid	1 80 .-
			LAY5-JB0x2	light grey - Base, yellow - lid	2 N/A
			LAY5-JB0x3	light grey - Base, yellow - lid	3 N/A
			LAY5-B0x1	light grey - Base, grey dark - lid	1 80 .-
			LAY5-B0x2	light grey - Base, grey dark - lid	2 110 .-
			LAY5-B0x3	light grey - Base, grey dark - lid	3 130 .-

Toggle Switch

Features

- The current has 10A and 15A
- Movement way has fixed type and auto-return type (both single-throw and double-throw can return)
- The terminal block has screw terminal and solder terminal (tab terminal also can be used)
- Rainproof cap, water-proof and oil-proof, it is suitable for full series products
- Mounting hole: ϕ 12mm

Model Designations

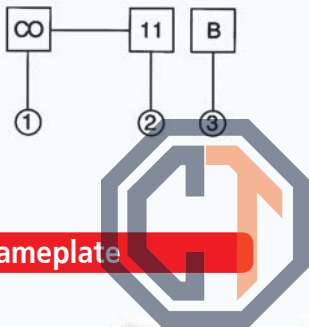

Nameplate



บริษัท ซีที อิเล็กทริก ซัพพลาย จำกัด

CT ELECTRIC SUPPLY CO., LTD.

โทร : 02-550-9555

Characteristics

Contact resistance	15M Ω max. (initial)
Insulation resistance	100M Ω - 500VDC under 500VDC
Dielectric strength	2000VAC, 50/60Hz For 1minute
Vibration	10 至 55Hz, 1.5mm double amplitude
Ambient temperature	-25 $^{\circ}$ C ~ +80 $^{\circ}$ C
Humidity	85% 85% RH max.
Life	Mechanical: 500,000 operations/min.
	Electrical: 100,000 operations/min.

Ratings

Load	Type	AC Rating	DC Rating
Resistance Load	CO	10A 250V 15A 125V	0.4A 250V 0.8A 125V
	C5	15A 250V 20A 125V	0.5A 250V 0.9A 125V
Inductive Load	CO	10A 250V 15A 250V	0.2A 250V 0.4A 125V
	C5	15A 250V 20A 125V	0.3A 250V 0.5A 125V 15A 30V
Lamp Load	CO	300W 100V 500W 200V	-
	C5	400W 125V 800W 250V	7A 30V
Motor Load	CO	200W 125V 300W 250V	-
	C5	400W 125V (single phase)	-
	CO	550W 250V (three phase)	-
	C5	750W 250V (three phase)	-

Items	Code	Description
Type	CO	10A 250VAC
	COR	10A 250VAC Spring return
	C5	15A 250VAC
	C5R	15A 250VAC Spring return
Contact	11	Single pole single throw ON-OFF
	12	Single pole double throw ON-ON
	13	(OFF)Single pole double throw (central OFF)ON-OFF-ON
	131	Single pole double throw (central OFF single return)ON-OFF-ON
	21	Double pole single throw ON-OFF
	22	Double pole double throw ON-ON
	23	(OFF)Double pole double throw (central OFF)ON-OFF-ON
231	OFF Double pole double throw (central OFF single return)ON-OFF-ON	
Terminal	A	Tab terminal(#250)
	B	Screw terminal
	C	Solder terminal(#187)

Appearance and Dimension

T-511B



T-5R11B



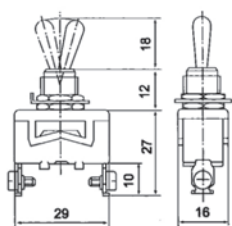

T-523B



T-5R23B



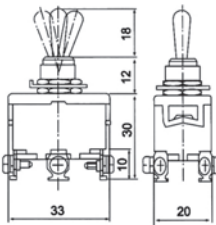

T-512B



T-5R12B



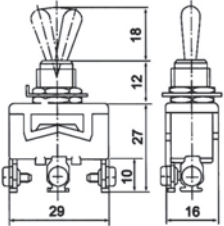

T-WC



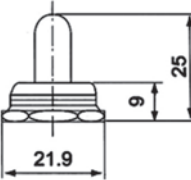

T-513B



T-5R13B



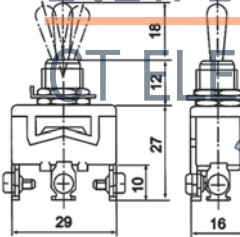

T-521B



T-5R21B



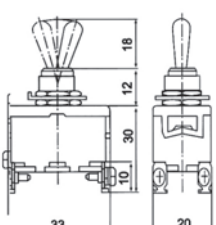

T-522B



T-5R22B



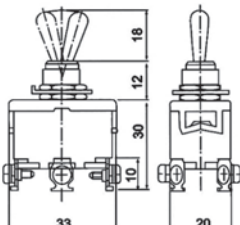

บริษัท ซีที อิเล็กทริก ซัพพลาย จำกัด

ติดต่อสายด่วน 15 A 250Vac (พร้อมเพนป้ายอุกมเนียม)

TEL: 02-550-9555

รุ่น (Model)	Pole	Kind of Operation	ขั้ว	บรรจุกล่อง:	ราคา (฿)
T-5R11B	1P	ON-OFF	2	20	100.-
T-5R12B	1P	ON-ON	3	20	110.-
T-5R13B	1P	ON-OFF-ON	3	20	110.-
T-5R21B	2P	ON-OFF	4	20	130.-
T-5R22B	2P	ON-ON	6	20	140.-
T-5R23B	2P	ON-OFF-ON	6	20	140.-
T-WC	-	Rainproof cap	-	20	45.-

รุ่น (Model)	Pole	Kind of Operation	ขั้ว	บรรจุกล่อง:	ราคา (฿)
T-511B	1P	ON-OFF	2	20	70.-
T-512B	1P	ON-ON	3	20	90.-
T-513B	1P	ON-OFF-ON	3	20	90.-
T-521B	2P	ON-OFF	4	20	105.-
T-522B	2P	ON-ON	6	20	115.-
T-523B	2P	ON-OFF-ON	6	20	115.-

Power Pushbutton Switch

SPECIFICATIONS :

Rated Voltage	: 440V
Contact Resistance	: 20M Ω
Insulation Resistance	: 100M Ω (at 500Vdc)
Ambient Temperature	: 40 °c
Service Life	: Electrical ≤ 50,000 operations Min. : Mechanical 100,000 operations Min.

Appearance and Dimension

BS211B



BS216B



BS230B



CBSN-315



CBSN-330



BSH-222/NEW



บริษัท ซีที อีเล็คทริค ซัพพลาย จำกัด
CT ELECTRIC SUPPLY CO., LTD.

โทร : 02 550 9555

BSH-223/NEW



BSH-222



BSH-223



สวิตช์กด (Power Pushbutton Switches)

รุ่น (Model)	Pole	Rated			ราคา (฿)
		A	KW	V	
BS211B	3P	10 A	0.75 KW	500 V	100 .-
BS216B	3P	15 A	2.2 KW	500 V	120 .-
BS230B	3P	30 A		500 V	155 .-
CBSN-315	3P	15 A	2.2 KW	440 V	150 .-
CBSN-330	3P	30 A	3.7 KW	440 V	210 .-

สวิตช์กดสำหรับแม่เหล็ก (Pushbutton Switches)

รุ่น (Model)	Detail	Rated		ราคา (฿)
		A	V	
BSH-222/New	ON-OFF	3 A	250 V	100 .-
BSH-223/New	FOR-REV-STOP	3 A	250 V	120 .-
สวิตช์กด (ไม่ล็อก)				
BSH-222	ON-OFF	1A, 3KW	500 V	110 .-
BSH-223	FOR-REV-STOP	1A, 3KW	500 V	200 .-

V Micro Switch

Model Designations

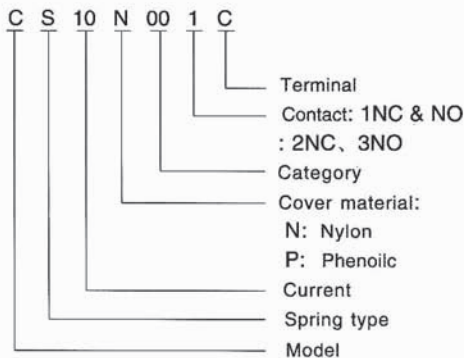

Performance

Contact resistance	15 m Ω max. (initial)
Insulation resistance	100m Ω min. (at 500VDC)
Dielectric strength	1,000 VAC 50/60 Hz. for 1 minute
Life	Mechanical: 10,000,000 operations min. Electrical: 100,000 operations min. (full load)

Outer Drawing

บริษัท ซีที อิเล็กทริค ซัพพลาย จำกัด

CT ELECTRIC SUPPLY CO., LTD.

โทร : 02-550-9555



Appearance and Dimension



V-15-1C25

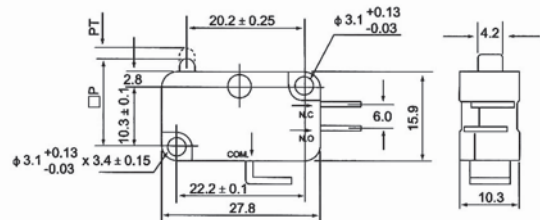

V-151-1C25

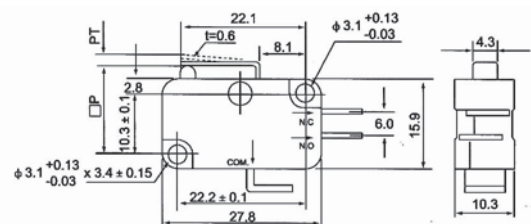

Appearance and Dimension



V-152-1C25

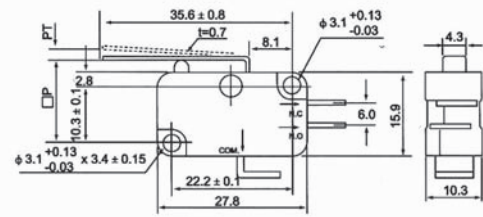

V-153-1C25

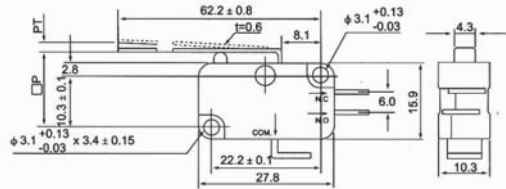

V-154-1C25

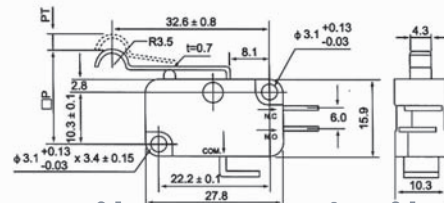

V-155-1C25

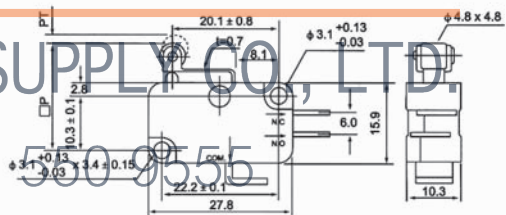

V-156-1C25

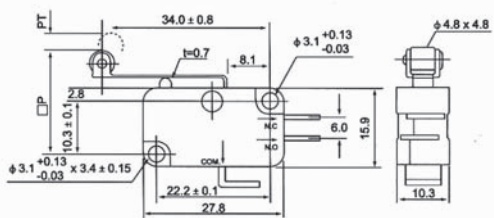

บริษัท ซีที อิเล็กทริก ซัพพลาย จำกัด
 CT ELECTRIC SUPPLY CO., LTD.
 โทร : 02 550 9555

รุ่น (Model)	ราคา/P (฿)
V-15-1C25	35.-
V-151-1C25	38.-
V-152-1C25	38.-
V-153-1C25	41.-
V-154-1C25	55.-
V-155-1C25	47.-
V-156-1C25	46.-

TM Micro Switch

Features

- Various of actuators, action position is adjustable (such as CM1701)
- High switch on and off capacity (15A)
- High accuracy
- Wide range of operation speed
- Each type of CM series has solder terminal, screw terminal and tab terminal are selective
- Add A for solder terminal, add C for tab terminal, blank for screw terminal



Ratings

额定电压 Rated voltage —	非电感性负载 Noninductive Load (A)				电感性负载 Inductive Load (A)				突入 电流(A) Inrush Current	
	电阻性负载 Resistance Load		灯泡负载 Lamp Load		电感性负载 Inductive Load		马达负载 Motor Load		NC	NO
	NC	NO	NC	NO	NC	NO	NC	NO		
125VAC	15	3	1.5	15	5	2.5	30	15		
250VAC	15	2.5	1.25	15	3	1.5	以下 max.	以下 max.		
500VAC	3	1.5	0.75	2.5	1.5	0.75				
8VDC	15	3	1.5	15	5	2.5				
14VDC	15	3	1.5	10	5	2.5				
30VDC	6(2)	3	1.5	5	5	2.5				
125VDC	0.4	0.4	0.4	0.05	0.05	0.05				
250VDC	0.2	0.2	0.2	0.03	0.03	0.03				

Contact Form



Characteristics

Operation speed	0.01mm-1m/sec
Operating frequency	Mechanical: 240 operations/min. Electrical: 20 operations/min.
Contact resistance	15mΩ max. (initial value)
Insulation resistance	100mΩ min. (at 500VDC)
Dielectric Strength	1000VAC, 50/60 Hz for 1 minute between terminals of the same polarity
	1500VAC, 50/60 HZ for 1 minute between current-carrying and non-current-carrying metal parts
	1500VAC, 50/60 HZ for 1 minute between each terminal and ground
Vibration	10-55Hz, 1.5mm double amplitude
Shock	Mechanical durable: 1,000m/Sec ² (about 100G'S) Malfunction: 300m/Sec ² (about 30G'S)
Ambient temperature	General purpose type: -25°C to +80°C, Sealed type: -15°C to +80°C
Humidity	General purpose type: 85% RH max., Sealed type: 95% RH max.
Life	Mechanical: 20,000,000 operations/min. Electrical: 500,000 operations/min.
Weight	About 22 to 58g

Terminal Type

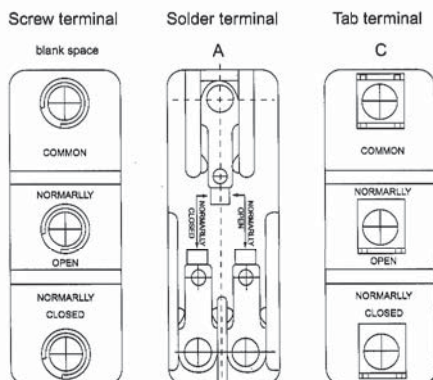

Appearance and Dimension

TM-1300 (Z-15G-B)

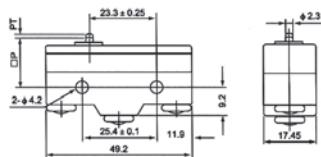

TM-1301 (Z-15GL-B)

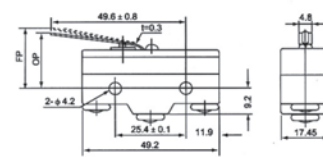

TM-1303 (Z-15GL2-B)

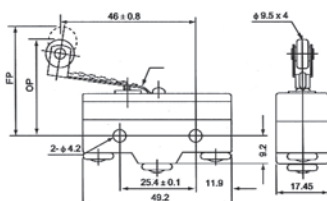

TM-1305 (Z-15GS-B)

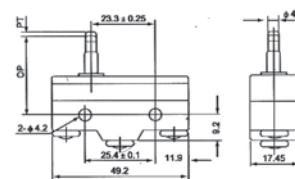

TM-1306 (Z-15GD-B)

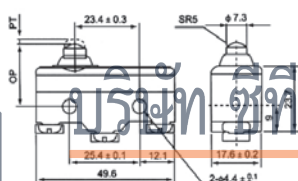
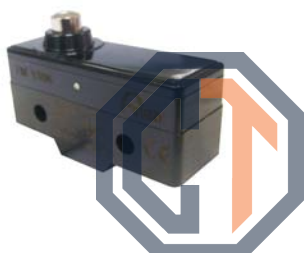

TM-1307 (Z-15GQ-B)

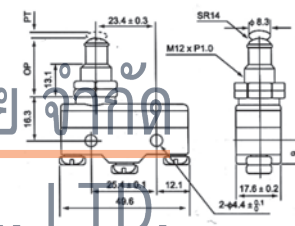

TM-1308 (Z-15GQ22-B)

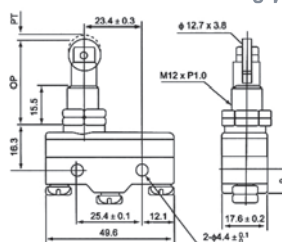

TM-1309 (Z-15GQ21-B)

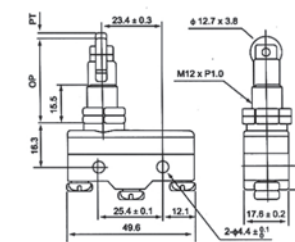

บริษัท ซีที อิเล็กทริค ซัพพลาย จำกัด
CT ELECTRIC SUPPLY CO., LTD.

โทร : 02 550 9555

TM-1300 Series 15A 250 AC.

Screw Clamp Terminal

รุ่น (Model)	Details	คอนเทค		บรรจุ (กล่อง)	ราคา/P (฿)
		N/O	N/C		
TM-1300	Pin plunger	1	1	20	100.-
TM-1301	Rigid plunger	-	-	20	105.-
TM-1303	Rigid roller plunger	-	-	20	120.-
TM-1305	Overtraval plunger	1	1	20	105.-
TM-1306	Compaq Overtraval plunger	1	1	20	105.-
TM-1307	Panel mount plunger	1	1	20	130.-
TM-1308	Panel mount roller plunger	1	1	20	165.-
TM-1309	Panel mount cross roller plunger	1	1	20	185.-

Appearance and Dimension

TM-1701

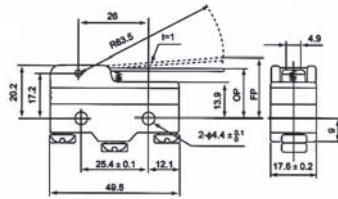

TM-1702

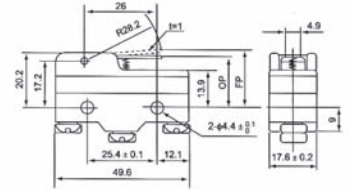

TM-1703

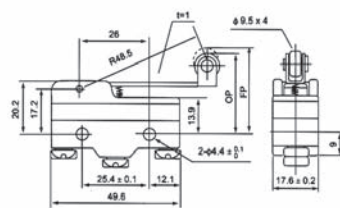

TM-1704

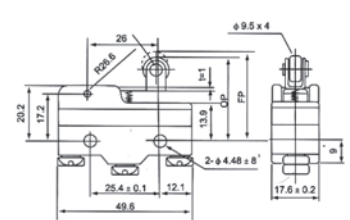

TM-1705

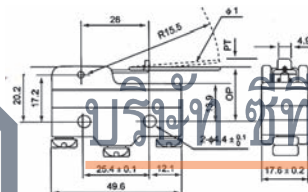
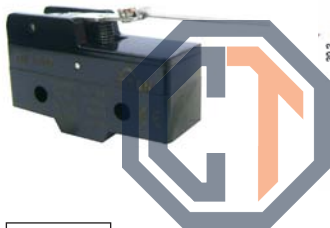

TM-1743

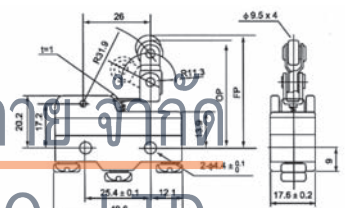

บริษัท อีเลคทริค ซัพพลาย จำกัด
CT ELECTRIC SUPPLY CO., LTD.

LPF



TM

โทร : 02 550 9555

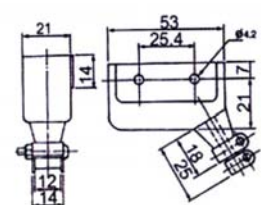

TM-1700 Series

Screw Clamp Terminal

รุ่น (Model)	Details	คอลูก		USST (กล่อง)	ราคา/P (B)
		N/O	N/C		
TM-1701	Rigid lever	1	1	20	115.-
TM-1702	-	-	-	20	115.-
TM-1703	Rigid roller lever	1	1	20	120.-
TM-1704	Rigid short roller lever	1	1	20	120.-
TM-1705	Low force wire hinge lever	1	1	20	150.-
TM-1743	Hinge roller lever	1	1	20	150.-
LPF	รุ่นตรง	-	-	100	60.-
TM	รุ่นเฉียง	-	-	100	36.-

TZ-7 Limit Switch

Features

- Variety of actuators, the operation position is adjustable (such as TZ-7121)
- Outer shell covered with intensive plastic, water-proof and oil-proof. The mechanical strength is better than CM type of micro switch, bear hitting

Contact Form

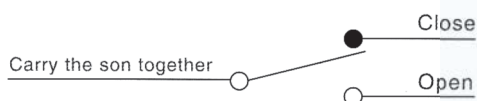

Characteristics

Operation speed	0.5mm-50cm/sec
Operating frequency	Mechanical: 120 operations/minute Electrical: 30 operations/minute
Contact resistance	15mΩ max. (initial value)
Insulation resistance	100mΩ above (at 500VDC)
Dielectric strength	1000VAC, 50/60 Hz for 1 minute between terminals of the same polarity
	1500VAC, 50/60 Hz for 1 minute between current-carrying and non-current-carrying metal parts
Vibration	1500VAC, 50/60 Hz for 1 minute between each terminal and ground
	Action: 10 to 55Hz, 1.5mm pairs swing
Shock rock	Mechanical durable: 1,000m/Sec ² (about 100g's) Malfunction: 300m/Sec ² (about 30g's)
Ambient temperature	使用时: -10 至 +80 °C
Humidity	< 95% RH
Life	Mechanical: 10,000,000 operations above (under rated OT) Electrical: 500,000 operations above
Weight	About 60g
Degree of protection	IP65

Ratings

Rated voltage	Noninductive Load (A)				Inductive Load (A)			
	Resistance Load		Lamp Load		Inductive Load		Motor Load	
	NC	NO	NC	NO	NC	NO	NC	NO
125VAC	10	3	1.5		10		5	2.5
250VAC	10	2.5	1.25		10		3	1.5
480VAC	3	1.5	0.75		2.5		1.5	0.75
8VDC	10	3	1.5		6		6	5
14VDC	10	3	1.5		6		6	5
30VDC	8	3	1.5		6		5	2.5
125VDC	0.5	0.4	0.4		0.05		0.05	0.05
250VDC	0.25	0.2	0.2		0.03		0.03	0.03

NOTES: 1. Inductive load has a power factor of 0.4 min. (AC) and a time constant of 7 msec. max. (DC).

Operating Characteristics

Models	TZ-7100	TZ-7110	TZ-7310	TZ-7311	TZ-7312	TZ-7120	TZ-7140	TZ-7121	TZ-7141	TZ-7124	TZ-7144	TZ-7166
OF (Max.)	600g	600g	600g	600g	600g	150g	220g	180g	240g	200g	280g	120g
RF (Min.)	100g	100g	100g	100g	100g	40g	60g	50g	80g	60g	100g	
PT (Max.)	2.0mm	2.0mm	2.0mm	2.0mm	2.0mm	13.5mm	8.5mm	11.0mm	6.5mm	11mm	6.5mm	250mm
OT (Min.)	0.8mm	5.0mm	6.0mm	6.0mm	6.0mm	4.0mm	2.5mm	3.0mm	2.0mm	3.0mm	2.0mm	11mm
MD (Max.)	0.8mm	0.8mm	0.8mm	0.8mm	0.8mm	3.2mm	2.0mm	2.4mm	1.5mm	2.4mm	1.5mm	
OP	30.5 ± 0.8mm	44 ± 1.2mm	21.8 ± 1.2mm	33.3 ± 1.2mm	33.3 ± 1.2mm	25 ± 1mm	25 ± 1mm	40 ± 1mm	40 ± 1mm	50 ± 1.2mm	50 ± 1.2mm	
FP						35mm	32mm		46mm		56mm	

Appearance and Dimension

TZ-7100

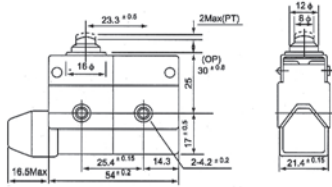

TZ-7110

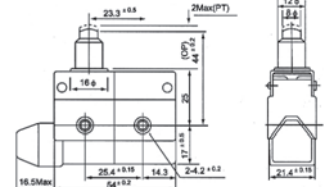

TZ-7120 (D4MC-1000)

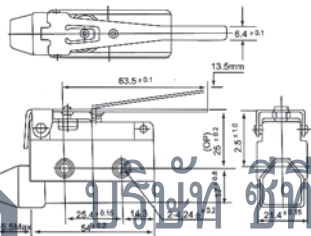
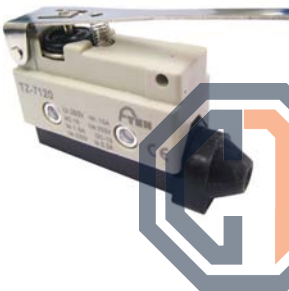

TZ-7121 (D4MC-2000)

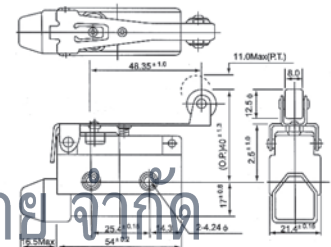

TZ-7124

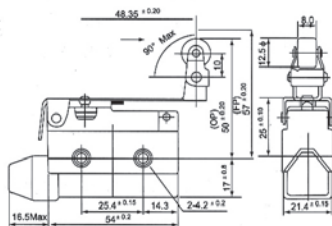

TZ-7140 (D4MC-1020)

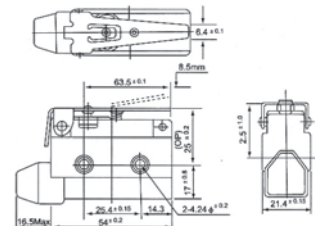

บริษัท ซีที อิเล็กทริค ซัพพลาย จำกัด
 CT ELECTRIC SUPPLY CO., LTD.

โทร : 02-550-9555

TZ-7000 Series

Screw Clamp Terminal

รุ่น (Model)	Details	คอนโทรล		บรรจุ (กล่อง)	ราคา/P (฿)
		N/O	N/C		
TZ-7100	Short push plunger	1	1	10	210.-
TZ-7110	Push plunger	1	1	10	215.-
TZ-7120	Hinge lever	1	1	10	200.-
TZ-7121	Roller plunger	1	1	10	200.-
TZ-7124	One-way roller lever	1	1	10	230.-
TZ-7140	Hinge short lever	1	1	10	200.-

Appearance and Dimension

TZ-7141 (D4MC-2020)

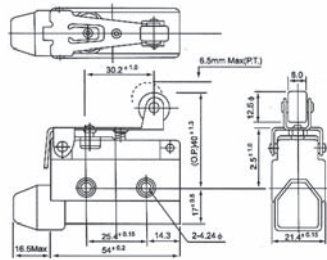

TZ-7144 (D4MC-3030)

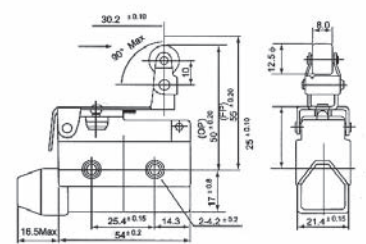

TZ-7166 (D4MC-5000)

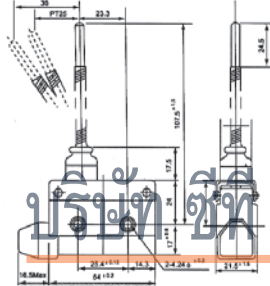
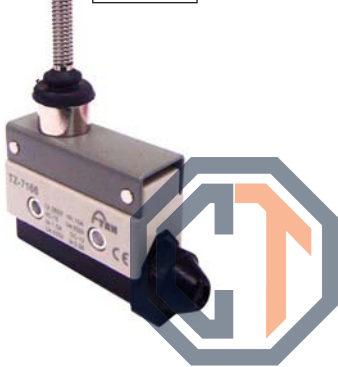

TZ-7310 (D4MC-5000)

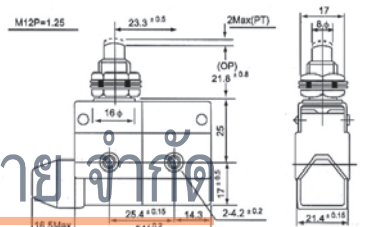

TZ-7311 (D4MC-5020)

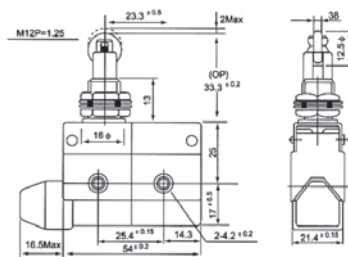

TZ-7312 (D4MC-5040)

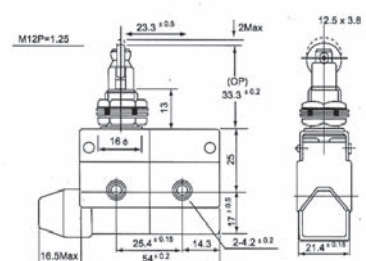

บริษัท ชีท อิเล็กทริก ขั้วพลาเย จากัด
CT ELECTRIC SUPPLY CO., LTD.

โทร : 02 550 9555

TZ-7000 Series

Screw Clamp Terminal

รุ่น (Model)	Details	คอนแทก		บรรจุ (กล่อง)	ราคา/พ (฿)
		N/O	N/C		
TZ-7141	Short roller lever	1	1	10	200.-
TZ-7144	One-way short roller lever	1	1	10	230.-
TZ-7166	Panel mount push plunger	1	1	10	290.-
TZ-7310	Panel mount roller plunger	1	1	10	240.-
TZ-7311	Panel mount cross roller plunger	1	1	10	255.-
TZ-7312	Flexible rob	1	1	10	255.-

TZ-8 Limit Switch

Features

- Double circuit type of limit switch
- Highly rigid construction, consists of intensive plastic and aluminum cast (Head and cover snugly fit in box)
- Small volume, water-proof and oil-proof construction
- Built-in basic switch with double spring mechanism, longer mechanical life
- Smooth operation with greater OT
- Easy-to-wire circuit opening design
- Wide variety of actuators, easily use

Contact Form

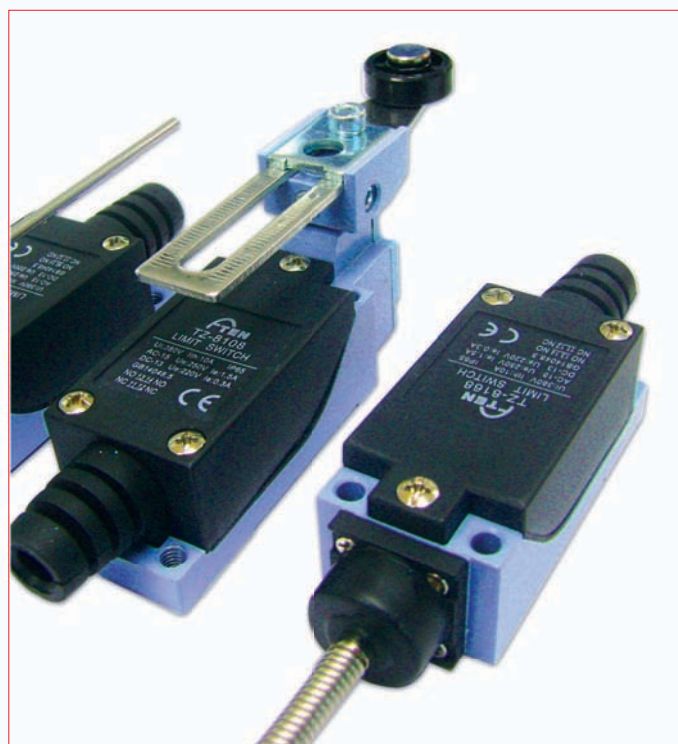

Characteristics

Operation speed	0.5mm-50cm/sec
Operating frequency	Mechanical: 120 operations/minute Electrical: 30 operations/minute
Contact resistance	25mΩ max. (initial value)
Insulation resistance	100mΩ min. (at 500VDC)
Dielectric strength	1000VAC, 50/60 Hz for 1 minute between terminals of the same polarity
	1500VAC, 50/60 Hz for 1 minute between current-carrying and non-current-carrying metal parts
Vibration	1500VAC, 50/60 Hz for 1 minute between each terminal and ground
	10-55Hz, 1.5mm double amplitude
Shock	Mechanical durable: 1,000m/Sec ² (about 100G'S) Malfunction: 300m/Sec ² (about 30G'S)
Ambient temperature	使用时: -5 至 +65℃
Humidity	<95% RH
Life	Mechanical: 10,000,000 operations above Electrical: 500,000 operations above
Weight	About 130 to 190g
Degree of protection	IP65

Ratings

Rated voltage	Noninductive Load (A)				Inductive Load (A)			
	NC	NO	NC	NO	NC	NO	NC	NO
125VAC	5	5	1.5	0.7	3	3	2	1
250VAC	5	5	1	0.5	3	3	1.5	0.8
600VAC								
8VDC	5	5	3	3	5	4	3	3
14VDC	5	5	3	3	4	4	3	3
30VDC	5	5	3	3	4	4	3	3
125VDC	0.4	0.4						
250VDC	0.2	0.2						
Inrush Current	N.C: below 24A, N.O: below 12A							

NOTES: 1. Inductive load has a power factor of 0.4 min.(AC) and a time constant of 7 msec. max.(DC).
2. Lamp load has an inrush current of 10 times the steady-state current, while motor load has an inrush current of 6 times the steady-state current.

Operating Characteristics

Models	TZ-8104	TZ-8108	TZ-8107	TZ-8111	TZ-8112/8122	TZ-8166/8167/8168/8169
OF (Max.)	750g	750g	750g	900g	900g	150g
RF (Min.)	100g	100g	100g	150g	150g	-
PT (Max.)	20°	20°	20°	1.5mm	1.5mm	30mm
OT (Min.)	50°	50°	50°	4mm	4mm	-
MD (Max.)	12°	12°	12°	1mm	1mm	-
OP	-	-	-	26 ± 0.8mm	37 ± 0.8mm	-

Appearance and Dimension

TZ-8104 (HL-5000)

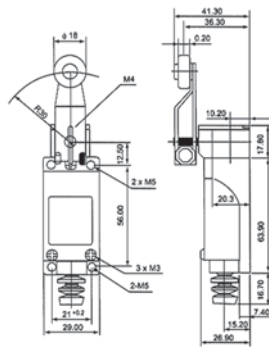

TZ-8107 (HL-5050)

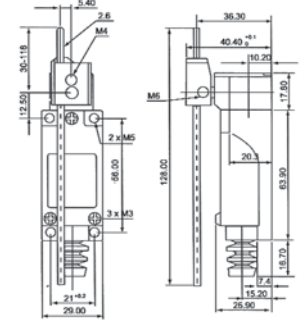
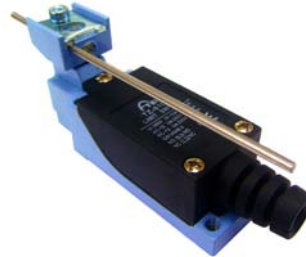

TZ-8108 (HL-5030)

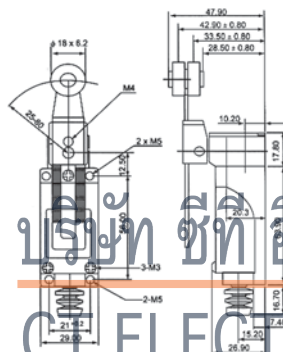
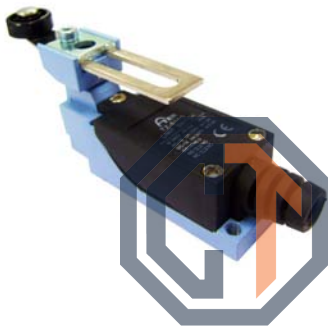

TZ-8111 (HL-5100)

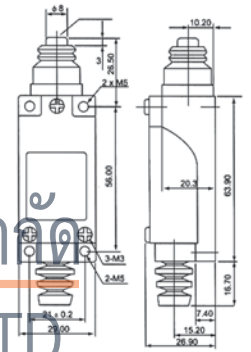

บริษัท ซีที อิเล็กทริก ซัพพลาย จำกัด
CT ELECTRIC SUPPLY CO., LTD.

โทร : 02 550 9555

TZ-8112 (HL-5200)

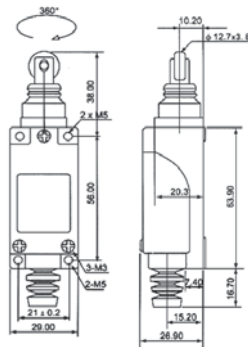

TZ-8122

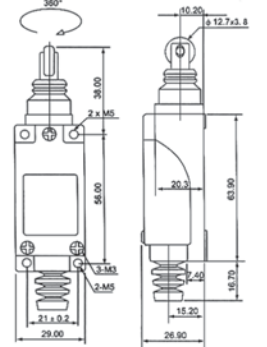

TZ-8000 Series

Screw Clamp Terminal

รุ่น (Model)	Details	คอนแทก		บรรจุ (กล่อง)	ราคา/P (฿)
		N/O	N/C		
TZ-8104	Roller arm	1	1	10	460.-
TZ-8107	Adjustable rod	1	1	10	490.-
TZ-8108	Adjustable roller arm	1	1	10	470.-
TZ-8111	Push plunger	1	1	10	440.-
TZ-8112	Roller plunger	1	1	10	450.-
TZ-8122	Cross roller plunger	1	1	10	450.-

Appearance and Dimension

TZ-8166 (HL-5300)

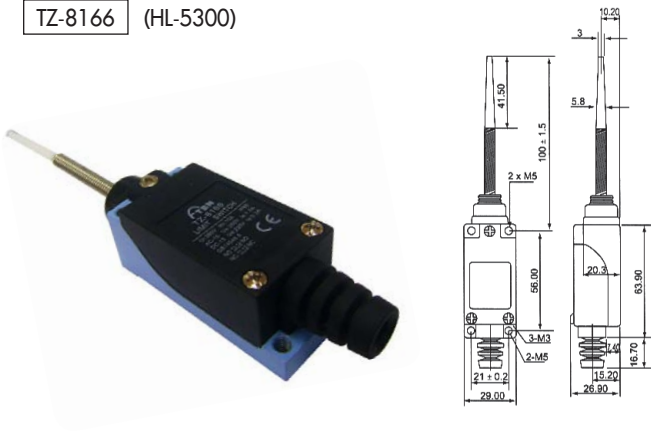

TZ-8167

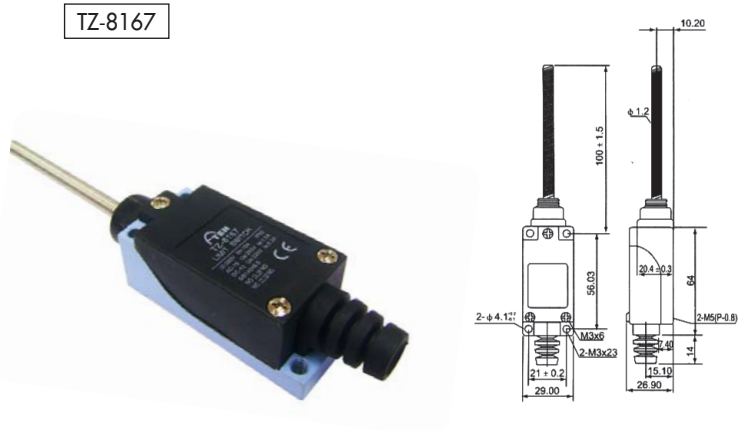

TZ-8168

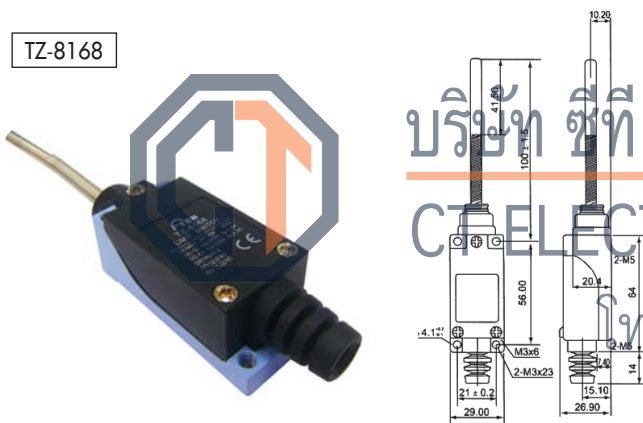

TZ-8169

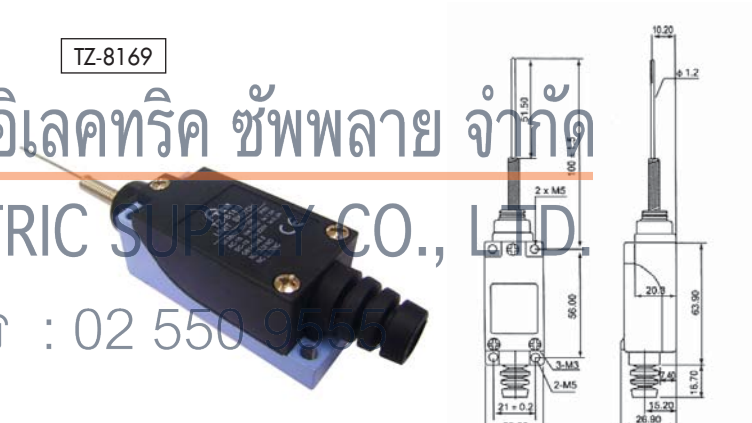

บริษัท ซีที อิเล็กทริก ซัพพลาย จำกัด
 CTELECTRIC SUPPLY CO., LTD.
 โทร : 02 550 9555

TZ-8000 Series

Screw Clamp Terminal

รุ่น (Model)	Details	คอนแทก		บรรจุ (กล่อง)	ราคา/P (฿)
		N/O	N/C		
TZ-8166	Plastic rod switches	1	1	10	470.-
TZ-8167	Coil spring switches	1	1	10	470.-
TZ-8168	Steel rod switches	1	1	10	470.-
TZ-8169	Spring wire switches	1	1	10	470.-

WLD Limit Switch

Features

- Double-circuit type of limit switch, is widely used
- With strong aluminum cast outer shell
- High mechanical strength
- Structure preventing oil, water and pressure
- Indicating plate with setting position is installed in it, so it is easy to maintain
- Various of actuators is taken convenience for using
- Built-in contact stand has double-spring, so it has long mechanical life

Contact Form

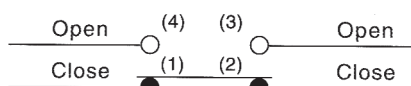

Characteristics

Operation speed	1mm-2m/s
Operating frequency	Mechanical: 120 operations/minute Electrical: 30 operations/minute
Contact resistance	15mΩ max. (initial value)
Insulation resistance	100mΩ min. (at 500VDC)
Dielectric strength	1000VAC, 50/60 Hz for 1 minute between terminals of the same polarity
	1500VAC, 50/60 Hz for 1 minute between current-carrying and non-current-carrying metal parts
Vibration	1500VAC, 50/60 Hz for 1 minute between each terminal and ground
	10-55Hz, 1.5mm double amplitude
Shock	Mechanical durable: 1,000m/Sec ² (about 100G'S) Malfunction: 300m/Sec ² (about 30G'S)
Ambient temperature	使用时: -10 至 +80℃
Humidity	<95% RH
Life	Mechanical: 15,000,000 operations above (under rated OT) Electrical: 500,000 operations above
Weight	About 275g
Degree of protection	IEC specification: IP67

Ratings

Rated Voltage	Noninductive Load (A)				Inductive Load (A)			
	Resistance Load		Lamp Load		Inductive Load		Motor Load	
	NC	NO	NC	NO	NC	NO	NC	NO
125VAC	10	5	3	1.5	10	5	3	2.0
250VAC	5	2	2	1	5	3	1.0	
480VAC	3	1	1.5	0.8	3	1.5	0.8	
600VAC	1	1	1	0.5	1.5	1	0.5	
8VDC	10	6	6	3	10	6	6	
14VDC	10	6	6	3	10	6	6	
30VDC	6	4	4	3	6	4	4	
125VDC	0.8	0.2	0.2	0.2	0.8	0.2	0.2	
250VDC	0.4	0.1	0.1	0.1	0.4	0.1	0.1	

NOTES: 1. Inductive load has a power factor of 0.4 min. (AC) and a time constant of 7 msec. max. (DC).
2. Lamp load has an inrush current of 10 times the steady-state current, while motor load has an inrush current of 6 times the steady-state current.

Operating Characteristics

Models	WLCA2-2	WLD2	WLNJ	WJNJ-S2	WJCA12-2-Q	WLCL	WLCA32-41	WLD	WLNJ-2	WLNJ-30	WLD1	WLD3
OF (Max.)	1360g	2720g	150g	29g	1360g	142g	1200g	2720g	120g	80g	2720g	2720g
RF (Min.)	227g	910g	-	-	227g	28g	-	910g	-	-	910g	910g
PT (Max.)	20°	1.7mm	28mm	28mm	20°	20°	55°	1.7mm	28mm	28mm	1.7mm	1.7mm
OT (Min.)	30°	5.6mm	-	-	30°	30°	35°	6.4mm	-	-	5.6mm	5.6mm
MD (Max.)	12°	1mm	-	-	12°	12°	-	1mm	-	-	1mm	1mm
TF (Max.)	2720g	-	-	-	2720g	200g	-	-	-	-	2720g	2720g
TT (Min.)	50°	6.5 ± 0.8mm	-	-	50°	50°	OP:90 ± 10° OP:34 ± 2.8mm	-	-	-	6.5 ± 0.8mm	9 ± 0.8mm

Appearance and Dimension

WLCA2-2 (TZ-5104-2)

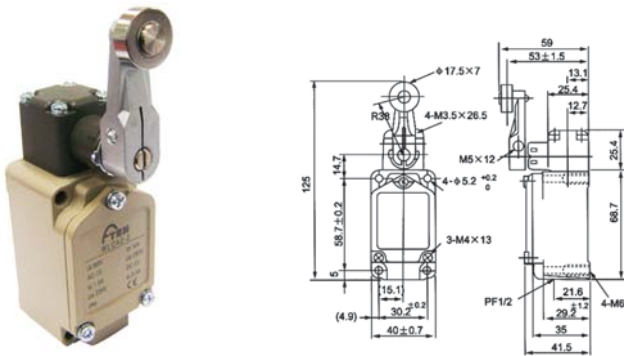

WLCA12-2-Q

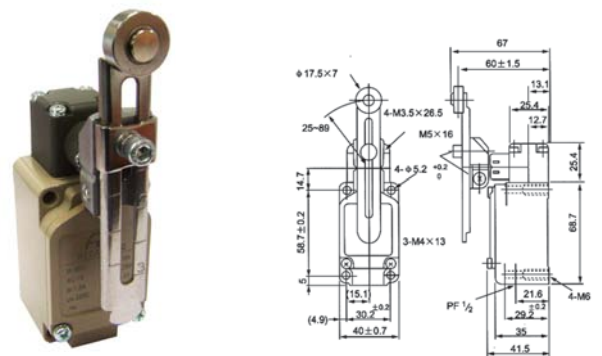

WLCA32-41 (TZ-5105)

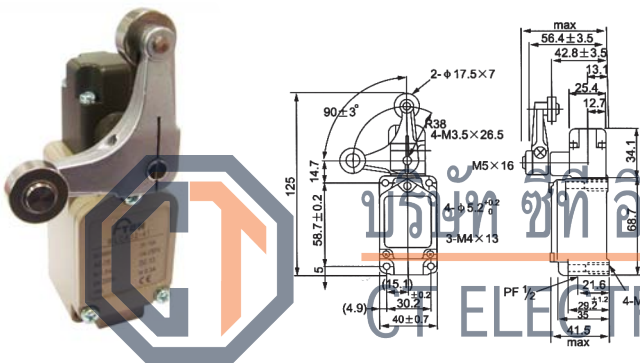

WLCL (TZ-5107)

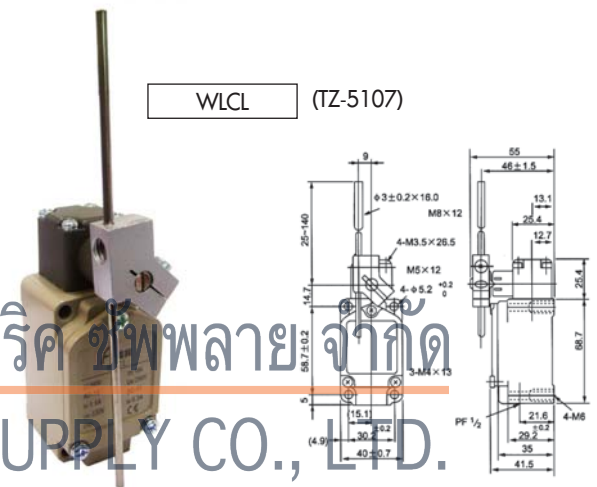

WLD

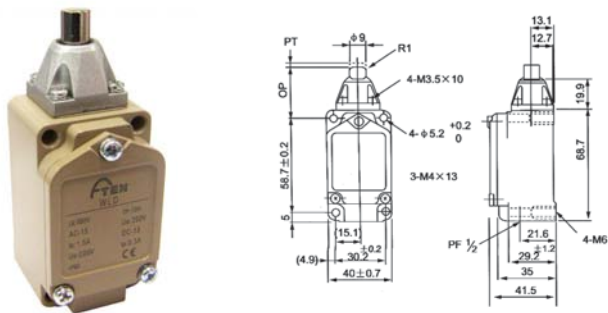

WLD1

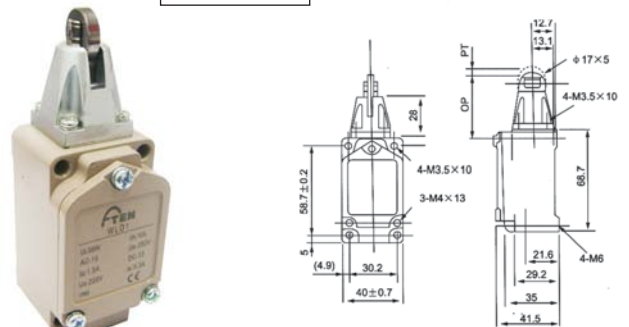

บริษัท ช่อเลิศทริค ซุปพลาย จำกัด
 ELECTRIC SUPPLY CO., LTD.

โทร : 02 550 9555

WL- Series

Screw Clamp Terminal

รุ่น (Model)	Details	คู่มือ		บรรจุ (กล่อง)	ราคา/P (฿)
		N/O	N/C		
WLCA2-2	Short roller lever	1	1	10	700.-
WLCA12-2-Q	Adjustable roller lever	1	1	10	740.-
WLCA32-41	Fork lever lock	1	1	10	850.-
WLCL	Adjustable rod lever	1	1	10	690.-
WLD	Plain plunger	1	1	10	600.-
WLD1	-	-	-	10	620.-

Appearance and Dimension

WLD2

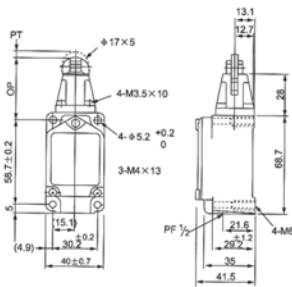

WLD3 (TZ-5109)

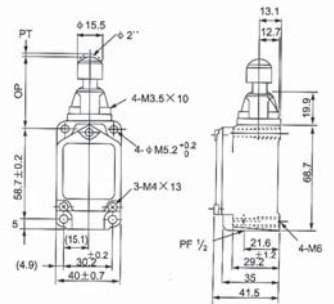

WLNJ (TZ-5106)

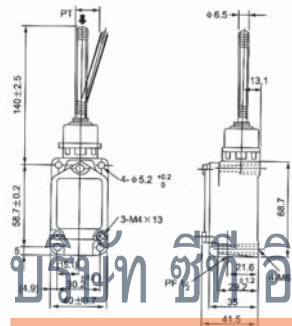

WLNJ-30

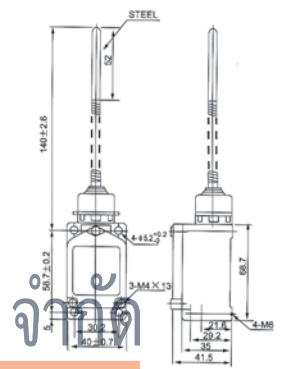

WLNJ-2

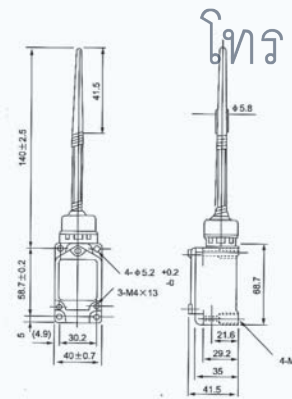

WLNJ-S2

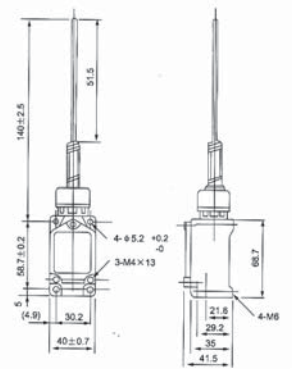

บริษัท ซีที อิเล็กทริก ซัพพลาย จำกัด
CT ELECTRIC SUPPLY CO., LTD.

โทร : 02 550 9555

WL- Series

Screw Clamp Terminal

รุ่น (Model)	Details	คอนแทก		บรรจุ (กล่อง)	ราคา/P (฿)
		N/O	N/C		
WLD2	Roller plunger	1	1	10	620.-
WLD3	Ball plunger	1	1	10	700.-
WLNJ	Coil spring (6.5 dia.)	1	1	10	630.-
WLNJ-30	Coil spring (5.0 dia.)	1	1	10	630.-
WLNJ-2	Nylon wire	1	1	10	630.-
WLNJ-S2	-	-	-	10	630.-

HL Limit Switch

Features

- Metallic bottom shell
- Stainless steel roller, punch and spring
- Strong electric property 10A, 250V, for 500,000 times

Electrical Life

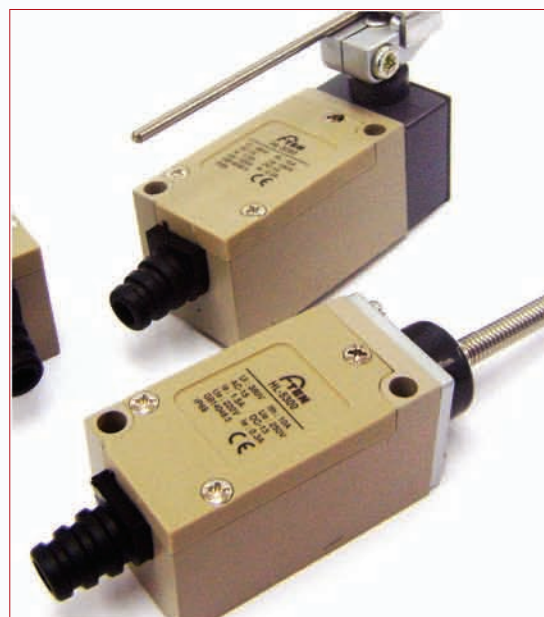
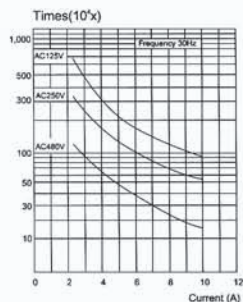

Characteristics

Double Break Mechanism	INO+INC Force Break snap action
Rated Voltage / Current	10(A) 25, 250VAC / 6(A), 380VAC For inductance Load, Cos φ =0.6
Contact Resistance	25m Ω max. (initial value)
Insulation Resistance	100m Ω min. (at 500VDC)
Dielectric Strength	1000VAC, 50/60 HZ for 1 minute between terminals of the same polarity 1500VAC, 50/60 HZ for 1 minute between current-carrying and non-current-carrying metal parts 1500VAC, 50/60 HZ for 1 minute between each terminal and ground
Electrical Life	500,000 at 10A 250VAC Resistive
Mechanical Life	10, 000, 000 operations min. (under rated conditions)
Operating Speed	5mm/s to 0.5m/s
Degree of Protection	IP65
Ambient Temperature Rised	Max 30℃ over ambient temperature at rated voltage/current
Conformed Standards	Cenelec EN 50041, EN 50047, IEC 337-1, VDE 0660
Operating Temperature	-5℃~+65℃ (with no icing)
Storage Temperature	-5℃~+65℃ (with no icing)
Ambient Operating Humdity	95° RH Max.
Shock Resistance	Mechanical durable: 1000m/s ² min. Malfunction: 300m/s ² min.
Vibration Frequency	Malfunction: 10 to 55HZ 1.5mm double amplitude
Terminal Screw Torsional Force	6-8 kgf-cm
Other Screw Torsional Force	Cover 12-14 kgf-cm/Head 8-9 kgf-cm/Mounting 50-60 kgf-cm
Bare Wire Diameter	φ 2 Max
Cable Diameter	φ 9 Max(IP 65 if use cable φ 8-9)

Specification

Model	HL	5000	5030	5050	5100	5200	5220	5300	5330	5381	5391
Operating force	OF (Max.)	750g-cm	750g-cm	750g-cm	750g-cm	900g-cm	900g-cm	150g	150g	150g	550g-cm
Release force	RF (Min.)	100g-cm	100g-cm	100g-cm	200g	200g	200g	30g	30g	30g	100g-cm
Pre-travel	PT (Max.)	20°	20°	20°	1.8mm	1.8mm	1.8mm	30mm	30mm	30mm	20°
Tripping position	TP ± 10%	22.5°	22.5°	22.5°	2.0mm	2.0mm	2.0mm	22.5°	22.5°	22.5°	22.5°
Movement differential	MD (Max.)	10°	10°	10°	1.2mm	1.2mm	1.2mm	14°	14°	14°	14°
Over travel	OT (Min.)	75°	75°	75°	4.0mm	4.0mm	4.0mm	20mm	20mm	20mm	75°
Total travel	TT (Min.)	95°	95°	95°	5.8mm	5.8mm	5.8mm	50mm	50mm	50mm	95°

Appearance and Dimension

HL-5000

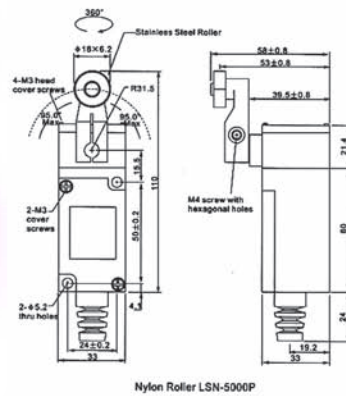

Nylon Roller LSN-5000P

HL-5220

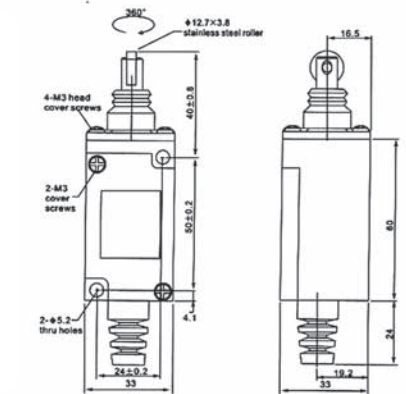

Direction of rotor CHL-5200

HL-5030

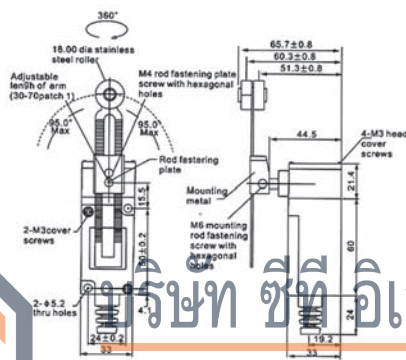

HL-5300

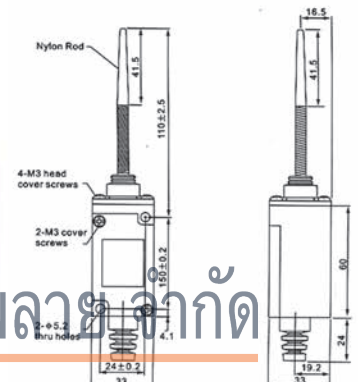

HL-5050

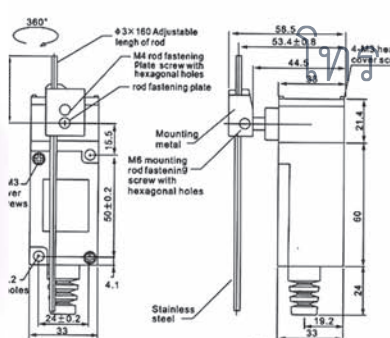

HL-5330

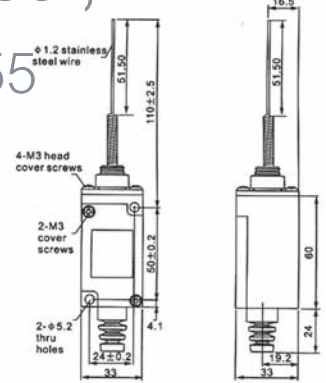

บริษัท ซีที อีเลคทริค ซัพพลาย จำกัด
CT ELECTRIC SUPPLY CO., LTD.

โทร : 02 550 9555

HL- Series

รุ่น (Model)	Details	คอนฟิก		บรรจุ (กล่อง)	ราคา/P (฿)
		N/O	N/C		
HL-5000	Roller lever			1	520 .-
HL-5030	Adjustable roller lever			1	550 .-
HL-5050	Adjustable rod lever			1	530 .-
HL-5220	Sw. หัวดีดลูกล้อต้านบน			1	470 .-
HL-5300	Coil spring			1	520 .-
HL-5330	Sw. ก้านสปริงลด			1	520 .-

Appearance and Dimension

HL-5100

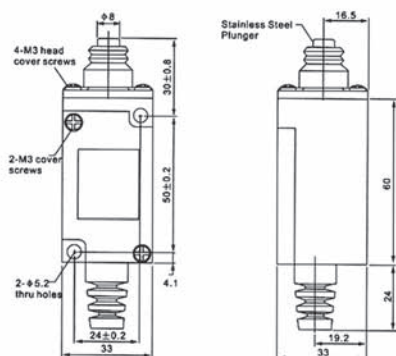

HL-5381

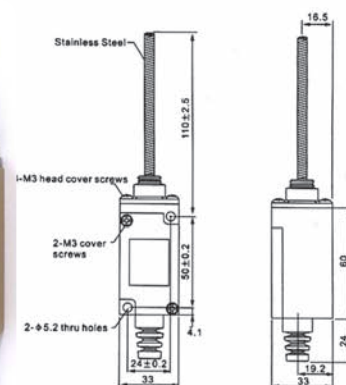

HL-5200

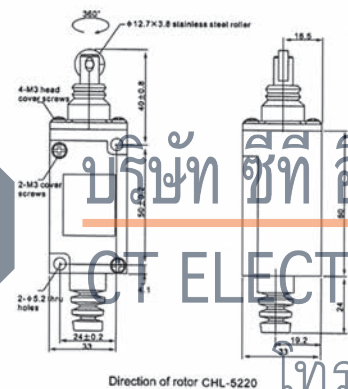
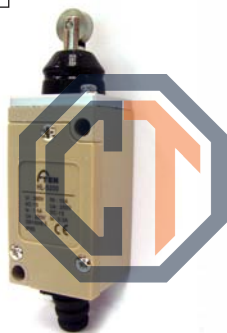

HL-5391

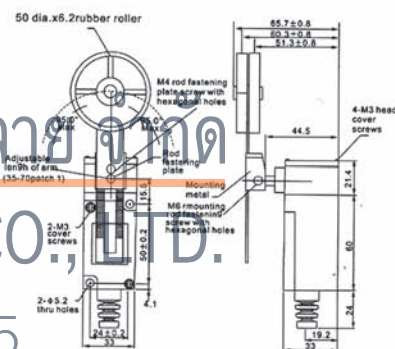

บริษัท ซีที อิเล็กทริก ซัพพลาย จำกัด
 CT ELECTRIC SUPPLY CO., LTD.
 โทร : 02 550 9555

HL- Series

รุ่น (Model)	Details	คอนฟิก		USRG (กล่อง)	ราคา/P (B)
		N/O	N/C		
HL-5100	Sealed plunger			1	460 .-
HL-5200	Sealed roller plunger			1	470 .-
HL-5381	Sw. ก้านสปริง			1	520 .-
HL-5391	Sw. ก้านตัวหัวลูกกลิ้งปรับได้			1	570 .-

Limit Switch

Features

- Economical & plastic type
- Stainless steel roller, punch and spring
- Swing amplitude, extra large $\pm 95^\circ$
- PG13.5 cable gland that can be equipped

Electrical Life

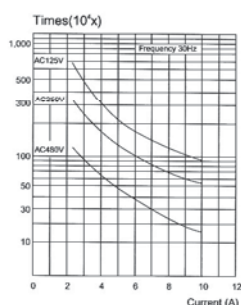

Characteristics

Double Break Mechanism	INO+INC Force Break snap action
Rated Voltage / Current	10(4)A, 125, 250VAC / 6(2)A, 380VAC For inductance Load, Cos $\phi = 0.4$
Contact Resistance	25m Ω max. (initial value)
Insulation Resistance	100m Ω min. (at 500VDC)
Dielectric Strength	1000VAC, 50/60 HZ for 1 minute between terminals of the same polarity
	1500VAC, 50/60 HZ for 1 minute between current-carrying and non-current-carrying metal parts 1500VAC, 50/60 HZ for 1 minute between each terminal and ground
Electrical Life	500, 000 at 10A 250VAC Resistive
Mechanical Life	10, 000, 000 operations min. (under rated conditions)
Operating Speed	5mm/s to 0.5m/s
Degree of Protection	IP65
Ambient Temperature Rised	Max 30 $^\circ$ C over ambient temperature at rated voltage/current
Conformed Standards	Cenelec EN 50041, EN 50047, IEC 337-1, VDE 0660
Operating Temperature	-5 $^\circ$ C~+65 $^\circ$ C (with no icing)
Storage Temperature	-5 $^\circ$ C~+65 $^\circ$ C (with no icing)
Ambient Operating Humdity	95% RH Max.
Shock Resistance	Mechanical durable: 1000m/s ² min.
	Malfuction: 300m/s ² min.
Vibration Frequency	Malfuction: 10 to 55Hz 1.5mm double amplitude
Terminal Screw Torsional Force	6-8 kgf-cm
Other Screw Torsional Force	Cover 12-14 kgf-cm/Head 8-9 kgf-cm/Mounting 50-60 kgf/cm
Bare Wire Diameter	ϕ 2 Max.
Cable Diameter	ϕ 12 Max.

Specifications

Model	CLS T	101 301	103 303	111 311	121 321	127 327	131 331	161 361	171 371	181 381	191 391
Operating force	OF (Max.)	700g	700g	700g	500g	700g	500g-cm	100g	100g	100g	500g-cm
Release force	RF (Min.)	200g	200g	200g	100g-cm	200g	100g-cm	40g	40g	40g	100g-cm
Pre-travel	PT (Max.)	1.8mm	1.8mm	1.8mm	20 $^\circ$	1.8mm	20 $^\circ$	30mm	30mm	30mm	20 $^\circ$
Tripping position	TP \pm 10%	2.0mm	2.0mm	2.0mm	22.5 $^\circ$	2.0mm	22.5 $^\circ$	22.5 $^\circ$	22.5 $^\circ$	22.5 $^\circ$	22.5 $^\circ$
Movement differential	MD (Max.)	1.2mm	1.2mm	1.2mm	10 $^\circ$	1.2mm	10 $^\circ$	14 $^\circ$	14 $^\circ$	14 $^\circ$	10 $^\circ$
Over travel	OT (Min.)	4.0mm	4.0mm	4.0mm	75 $^\circ$	4.0mm	75 $^\circ$	20mm	20mm	20mm	75 $^\circ$
Total travel	TT (Min.)	5.8mm	5.8mm	5.8mm	95 $^\circ$	5.8mm	95 $^\circ$	50mm	50mm	50mm	95 $^\circ$
Rotary indexing					22.5 $^\circ$		22.5 $^\circ$				22.5 $^\circ$

Appearance and Dimension

TLS-101

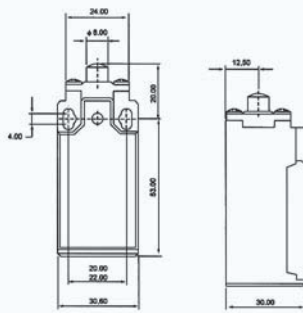

TLS-131

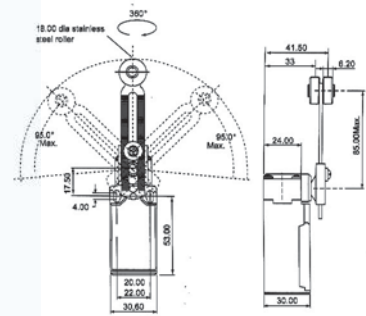

TLS-103

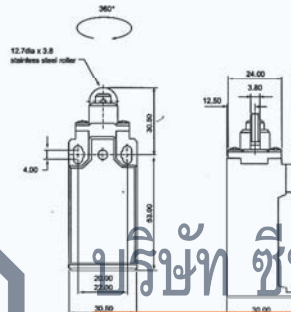

TLS-161

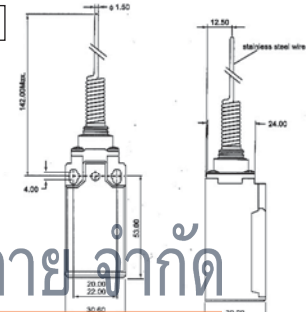

TLS-111

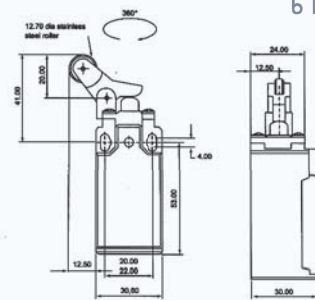

TLS-171

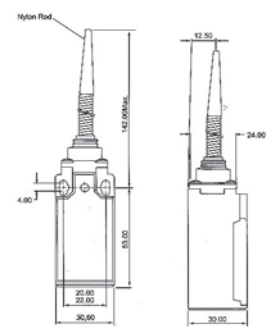

บริษัท ซีที อิเล็กทริค ซัพพลาย จำกัด
CT ELECTRIC SUPPLY CO., LTD.

โทร : 02 550 9555

TLS - Series

Screw Clamp Terminal

รุ่น (Model)	Details	คอนิภาค		บรรจุ (กล่อง)	ราคา/P (฿)
		N/O	N/C		
TLS-101	Sw. หัวปุ่มยื่นด้านบน	-	-	10	300 .-
TLS-103	Sw. หัวติดลูกกลิ้งด้านบน	-	-	10	310 .-
TLS-111	Sw. ก้านติดหัวลูกกลิ้งด้านบน	-	-	10	330 .-
TLS-131	Sw. ก้านติดหัวลูกกลิ้งรับใต้	-	-	10	310 .-
TLS-161	Sw. ก้านบริเวณ	-	-	10	310 .-
TLS-171	Sw. ก้านในลอนหุ่นทรง	-	-	10	310 .-

Appearance and Dimension

TLS-121

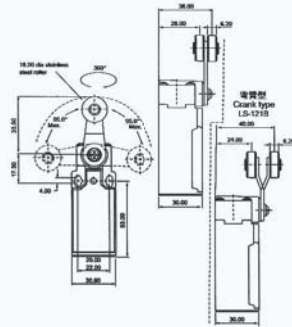

TLS-181

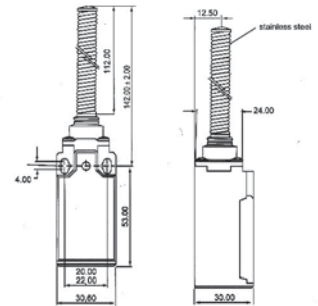

TLS-127

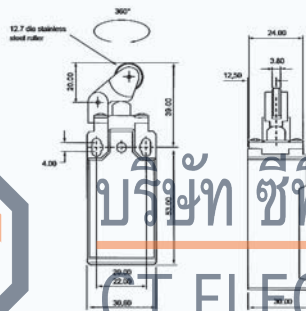

TLS-191

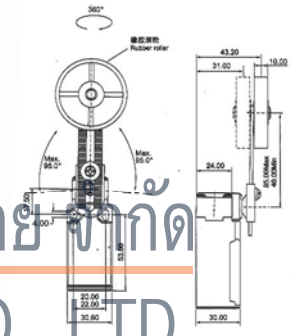

บริษัท ซีที อิเล็กทริค ซัพพลาย จำกัด
 CT ELECTRIC SUPPLY CO., LTD.

โทร : 02 550 9555

TLS - Series

Screw Clamp Terminal

รุ่น (Model)	Details	คอนแทก		บรรจุ (กล่องละ)	ราคา/P (฿)
		N/O	N/C		
TLS-121	Sw. ก้านติดหัวลูกกลิ้ง	-	-	10	300 .-
TLS-127	Sw. ก้านติดหัวลูกกลิ้งด้านบน	-	-	10	330 .-
TLS-181	Sw. ก้านสปริง	-	-	10	310 .-
TLS-191	Sw. ก้านหัวติดลูกกลิ้งยางปรับได้	-	-	10	370 .-

Industrial Plugs, Sockets/Connectors/Insulated Clamp/MCB Flush Enclosures

ปลั๊กตัวผู้ (Plugs) AT-013, AT-023 IP44

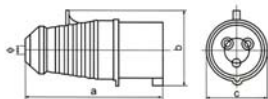

Earth contact position	6h	
Rated current (A)	16	32
Pole	3	
Dimension (mm)	a	122
	b	57
	c	50
∅	6	8

รุ่น (Model)	Pole	Rated Voltage	Rated Current	สี Color	ราคา (฿)
AT-013	2P + E	220-240 V	16 A	Blue	100.-
AT-023	2P + E	220-240 V	32 A	Blue	135.-

ปลั๊กตัวผู้ (Plugs) AT-014, AT-024 IP44

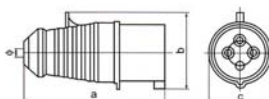

Earth contact position	6h	
Rated current (A)	16	32
Pole	4	
Dimension (mm)	a	122
	b	57
	c	50
∅	6	8

รุ่น (Model)	Pole	Rated Voltage	Rated Current	สี Color	ราคา (฿)
AT-014	3P + E	380-415 V	16 A	Red	120.-
AT-024	3P + E	380-415 V	32 A	Red	160.-

ปลั๊กตัวผู้ (Plugs) AT-015, AT-025 IP44

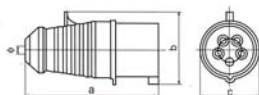

Earth contact position	6h	
Rated current (A)	16	32
Pole	5	
Dimension (mm)	a	130
	b	75
	c	64
∅	8	8

รุ่น (Model)	Pole	Rated Voltage	Rated Current	สี Color	ราคา (฿)
AT-015	3P + N + E	380-415 V	16 A	Red	140.-
AT-025	3P + N + E	380-415 V	32 A	Red	180.-

เต้ารับลอยติดผนัง (Wall Socket) AT-113, AT-123 IP44

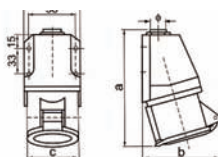

Earth contact position	6h	
Rated current (A)	16	32
Pole	3	
Dimension (mm)	a	135
	b	92
	c	50
∅	3-18	3-18

รุ่น (Model)	Pole	Rated Voltage	Rated Current	สี Color	ราคา (฿)
AT-113	2P + E	220-240 V	16 A	Blue	175.-
AT-123	2P + E	220-240 V	32 A	Blue	240.-

Industrial Plugs, Sockets/Connectors/Insulated Clamp/MCB Flush Enclosures

เต้ารับลอยติดผนัง (Wall Socket) AT-114, AT-124 IP44



รุ่น (Model)	Pole	Rated Voltage	Rated Current	สี Color	ราคา (฿)
AT-114	3P + E	380-415 V	16 A	Red	185.-
AT-124	3P + E	380-415 V	32 A	Red	270.-

Earth contact position	6h	
Rated current (A)	16	32
Pole	4	
Dimension (mm)	a	140
	b	95
	c	56
∅	3-18	3-18

เต้ารับลอยติดผนัง (Wall Socket) AT-115, AT-125 IP44



รุ่น (Model)	Pole	Rated Voltage	Rated Current	สี Color	ราคา (฿)
AT-115	3P + N + E	380-415 V	16 A	Red	205.-
AT-125	3P + N + E	380-415 V	32 A	Red	290.-

Earth contact position	6h	
Rated current (A)	16	32
Pole	5	
Dimension (mm)	a	139
	b	96
	c	63
∅	3-18	3-18

เต้ารับกลางทาบ (Coupler Socket) AT-213, AT-223 IP44

โทร : 02 550 9555



รุ่น (Model)	Pole	Rated Voltage	Rated Current	สี Color	ราคา (฿)
AT-213	2P + E	220-240 V	16 A	Blue	140.-
AT-223	2P + E	220-240 V	32 A	Blue	180.-

Earth contact position	6h	
Rated current (A)	16	32
Pole	3	
Dimension (mm)	a	131
	b	69
	c	50.5
∅	6-16	8-20

เต้ารับกลางทาบ (Coupler Socket) AT-214, AT-224 IP44



รุ่น (Model)	Pole	Rated Voltage	Rated Current	สี Color	ราคา (฿)
AT-214	3P + E	380-415 V	16 A	Red	145.-
AT-224	3P + E	380-415 V	32 A	Red	210.-

Earth contact position	6h	
Rated current (A)	16	32
Pole	4	
Dimension (mm)	a	131
	b	79
	c	56
∅	6-16	8-20

Industrial Plugs, Sockets/Connectors/Insulated Clamp/MCB Flush Enclosures

เต้ารับสายทอง (Coupler Socket) AT-215, AT-225 IP44

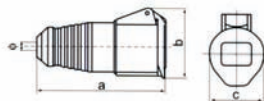

รุ่น (Model)	Pole	Rated Voltage	Rated Current	สี Color	ราคา (฿)
AT-215	3P + N + E	380-415 V	16 A	Red	170.-
AT-225	3P + N + E	380-415 V	32 A	Red	245.-

Earth contact position	6h	
Rated current (A)	16	32
Pole	5	
Dimension (mm)	a	141
	b	93
	c	64
∅	8-20	8-20

เต้ารับแผง (Panel Socket) AT-313, AT-323 IP44

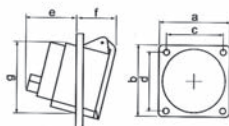

รุ่น (Model)	Pole	Rated Voltage	Rated Current	สี Color	ราคา (฿)
AT-313	2P + E	220-240 V	16 A	Blue	125.-
AT-323	2P + E	220-240 V	32 A	Blue	200.-

Earth contact position	6h	
Rated current (A)	16	32
Pole	3	
Dimension (mm)	a	62
	b	68
	c	47
d	48	70
e	36	42
f	37	43
g	55	75

เต้ารับแผง (Panel Socket) AT-314, AT-324 IP44

โทร : 02 550 9555

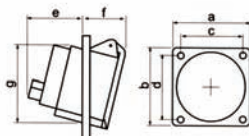

รุ่น (Model)	Pole	Rated Voltage	Rated Current	สี Color	ราคา (฿)
AT-314	3P + E	380-415 V	16 A	Red	150.-
AT-324	3P + E	380-415 V	32 A	Red	210.-

Earth contact position	6h	
Rated current (A)	16	32
Pole	4	
Dimension (mm)	a	76
	b	86
	c	60
d	61	70
e	47	42
f	37	43
g	64	75

เต้ารับแผง (Panel Socket) AT-315, AT-325 IP44

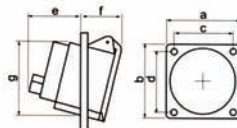

รุ่น (Model)	Pole	Rated Voltage	Rated Current	สี Color	ราคา (฿)
AT-315	3P + N + E	380-415 V	16 A	Red	170.-
AT-325	3P + N + E	380-415 V	32 A	Red	230.-

Earth contact position	6h	
Rated current (A)	16	32
Pole	5	
Dimension (mm)	a	76
	b	86
	c	60
d	61	70
e	47	42
f	37	47
g	72	81

Industrial Plugs, Sockets/Connectors/Insulated Clamp/MCB Flush Enclosures

ปลั๊กตัวผู้รุ่นกันน้ำ (Plugs) AT-0132, AT-0232 IP67

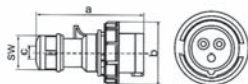

Earth contact position	6h	
Rated current (A)	16	32
Pole	3	
Dimension (mm)	a	118 146
	b	80 93
	c	6-15 10-20
sw	38	50

รุ่น (Model)	Pole	Rated Voltage	Rated Current	สี Color	ราคา (฿)
AT-0132	2P + E	220-240 V	16 A	Blue	145.-
AT-0232	2P + E	220-240 V	32 A	Blue	240.-

ปลั๊กตัวผู้รุ่นกันน้ำ (Plugs) AT-033 IP67

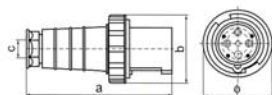

Earth contact position	6h	
Rated current (A)	63	
Pole	3	
Dimension (mm)	a	231.5
	b	110
	c	16-38
∅	110	

รุ่น (Model)	Pole	Rated Voltage	Rated Current	สี Color	ราคา (฿)
AT-033	2P + E	220-240 V	63 A	Blue	540.-

ปลั๊กตัวผู้รุ่นกันน้ำ (Plugs) AT-0142, AT-0242 IP67

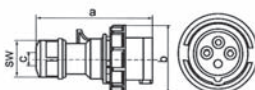

Earth contact position	6h	
Rated current (A)	16	32
Pole	4	
Dimension (mm)	a	124 146
	b	79 93
	c	6-15 10-20
sw	38	50

รุ่น (Model)	Pole	Rated Voltage	Rated Current	สี Color	ราคา (฿)
AT-0142	3P + E	380-415 V	16 A	Red	170.-
AT-0242	3P + E	380-415 V	32 A	Red	270.-

ปลั๊กตัวผู้รุ่นกันน้ำ (Plugs) AT-034 IP67

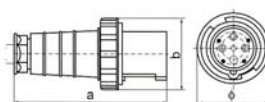

Earth contact position	6h	
Rated current (A)	63	
Pole	4	
Dimension (mm)	a	231.5
	b	110
	c	16-38
∅	110	

รุ่น (Model)	Pole	Rated Voltage	Rated Current	สี Color	ราคา (฿)
AT-034	3P + E	380-415 V	63 A	Red	620.-

บริษัท ซีที อีเลคทริก ซัพพลาย จำกัด
CT ELECTRIC SUPPLY CO., LTD.

โทร : 02 550 9555

Industrial Plugs, Sockets/Connectors/Insulated Clamp/MCB Flush Enclosures

ปลั๊กตัวผู้รุ่นกันน้ำ (Plugs) AT-0152, AT-0252 IP67

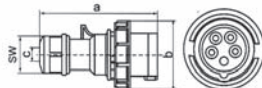

Earth contact position	6h	
Rated current (A)	16	32
Pole	5	
Dimension (mm)	a	133
	b	87
	c	8-16
	sw	42

รุ่น (Model)	Pole	Rated Voltage	Rated Current	สี Color	ราคา (฿)
AT-0152	3P + N + E	380-415 V	16 A	Red	220.-
AT-0252	3P + N + E	380-415 V	32 A	Red	320.-

ปลั๊กตัวผู้รุ่นกันน้ำ (Plugs) AT-035 IP67

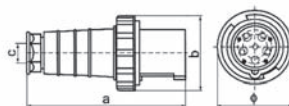

Earth contact position	6h	
Rated current (A)	63	
Pole	4	
Dimension (mm)	a	231.5
	b	110
	c	16-38
	d	110

รุ่น (Model)	Pole	Rated Voltage	Rated Current	สี Color	ราคา (฿)
AT-035	3P + N + E	380-415 V	63 A	Red	670.-

เต้ารับลอยติดตั้งผนังรุ่นกันน้ำ (Wall Socket) AT-1132, AT-1232 IP67

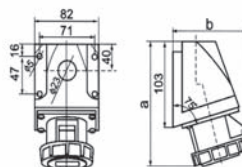

Earth contact position	6h	
Rated current (A)	16	32
Pole	3	
Dimension (mm)	a	155
	b	99

รุ่น (Model)	Pole	Rated Voltage	Rated Current	สี Color	ราคา (฿)
AT-1132	2P + E	220-240 V	16 A	Blue	280.-
AT-1232	2P + E	220-240 V	32 A	Blue	360.-

เต้ารับลอยติดตั้งผนังรุ่นกันน้ำ (Wall Socket) AT-133 IP67

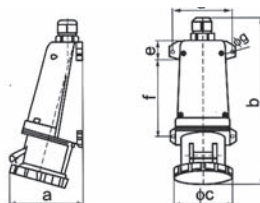
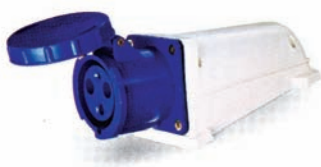

Earth contact position	6h	
Rated current (A)	63	
Pole	3	
Dimension (mm)	a	134
	b	311
	c	108
	d	111
	e	20
	f	155
	g	6

รุ่น (Model)	Pole	Rated Voltage	Rated Current	สี Color	ราคา (฿)
AT-133	2P + E	220-240 V	63 A	Blue	870.-

Industrial Plugs, Sockets/Connectors/Insulated Clamp/MCB Flush Enclosures

เต้ารับลอยตีตพผนังรุ่นกันน้ำ (Wall Socket) AT-1142, AT-1242 IP67

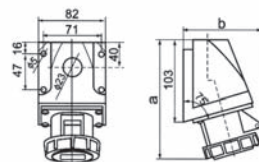
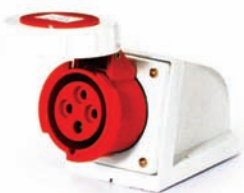

รุ่น (Model)	Pole	Rated Voltage	Rated Current	สี Color	ราคา (฿)
AT-1142	3P + E	380-415 V	16 A	Red	300.-
AT-1242	3P + E	380-415 V	32 A	Red	410.-

Earth contact position	6h	
Rated current (A)	16	32
Pole	4	
Dimension (mm)	a	155
	b	101
		108

เต้ารับลอยตีตพผนังรุ่นกันน้ำ (Wall Socket) AT-134 IP67

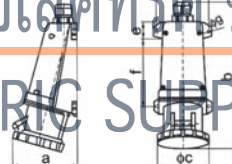

รุ่น (Model)	Pole	Rated Voltage	Rated Current	สี Color	ราคา (฿)
AT-134	3P + E	380-415 V	63 A	Red	920 .-

Earth contact position	6h	
Rated current (A)	63	
Pole	4	
Dimension (mm)	a	134
	b	311
	c	108
	d	111
	e	20
	f	155
	g	6

บริษัท ซีที อิเล็กทริค ซัพพลาย จำกัด
 CT ELECTRIC SUPPLY CO., LTD.
 โทร : 02 550 9555

เต้ารับลอยตีตพผนังรุ่นกันน้ำ (Wall Socket) AT-1152, AT-1252 IP67

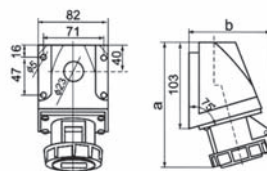

รุ่น (Model)	Pole	Rated Voltage	Rated Current	สี Color	ราคา (฿)
AT-1152	3P + N + E	380-415 V	16 A	Red	370.-
AT-1252	3P + N + E	380-415 V	32 A	Red	470.-

Earth contact position	6h	
Rated current (A)	16	32
Pole	5	
Dimension (mm)	a	155
	b	106
		111

Industrial Plugs, Sockets/Connectors/Insulated Clamp/MCB Flush Enclosures

เต้ารับลอยติดผนังรุ่นกันน้ำ (Wall Socket) AT-135 IP67

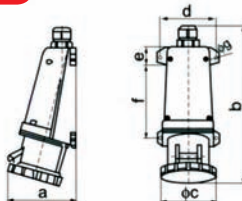

Earth contact position	6h	
Rated current (A)	63	
Pole	5	
Dimension (mm)	a	134
	b	311
	c	108
	d	111
	e	20
	f	155
	g	6

รุ่น (Model)	Pole	Rated Voltage	Rated Current	สี Color	ราคา (฿)
AT-135	3P + N + E	380-415 V	63 A	Red	1,020 .-

เต้ารับกลางทาง รุ่นกันน้ำ (Coupler Socket) AT-2132, AT-2232 IP67

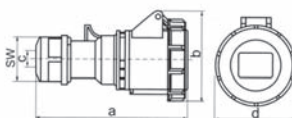

Earth contact position	6h	
Rated current (A)	16	32
Pole	3	
Dimension (mm)	a	130
	b	163
	c	97
	d	71
	sw	38
		10-20

รุ่น (Model)	Pole	Rated Voltage	Rated Current	สี Color	ราคา (฿)
AT-2132	2P + E	220-240 V	16 A	Blue	240 .-
AT-2232	2P + E	220-240 V	32 A	Blue	330 .-

เต้ารับกลางทาง รุ่นกันน้ำ (Coupler Socket) AT-233 IP67

โทร : 02 550 9555

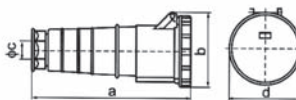

Earth contact position	6h	
Rated current (A)	63	
Pole	3	
Dimension (mm)	a	240
	b	115
	c	16-38
	d	108

รุ่น (Model)	Pole	Rated Voltage	Rated Current	สี Color	ราคา (฿)
AT-233	2P + E	220-240 V	63 A	Blue	800 .-

เต้ารับกลางทาง รุ่นกันน้ำ (Coupler Socket) AT-2142, AT-2242 IP67

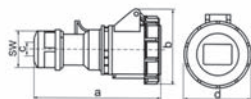

Earth contact position	6h	
Rated current (A)	16	32
Pole	4	
Dimension (mm)	a	138
	b	87
	c	6-15
	d	80
	sw	38
		10-20

รุ่น (Model)	Pole	Rated Voltage	Rated Current	สี Color	ราคา (฿)
AT-2142	3P + E	380-415 V	16 A	Red	260 .-
AT-2242	3P + E	380-415 V	32 A	Red	340 .-

Industrial Plugs, Sockets/Connectors/Insulated Clamp/MCB Flush Enclosures

เต้ารับกลางทาง รุ่นกันน้ำ (Coupler Socket) AT-234 IP67

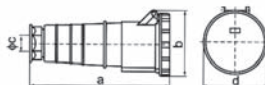

Earth contact position	6h	
Rated current (A)	63	
Pole	4	
Dimension (mm)	a	240
	b	115
	c	16-38
	d	108

รุ่น (Model)	Pole	Rated Voltage	Rated Current	สี Color	ราคา (฿)
AT-234	3P + E	380-415 V	63 A	Red	850 .-

เต้ารับกลางทาง รุ่นกันน้ำ (Coupler Socket) AT-2152, AT-2252 IP67

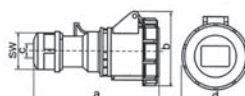

Earth contact position	6h	
Rated current (A)	16	32
Pole	5	
Dimension (mm)	a	145 168
	b	93 104
	c	8-16 12-22
	d	87 100
	sw	42 50

รุ่น (Model)	Pole	Rated Voltage	Rated Current	สี Color	ราคา (฿)
AT-2152	3P + N + E	380-415 V	16 A	Red	290 .-
AT-2252	3P + N + E	380-415 V	32 A	Red	410 .-

เต้ารับกลางทาง รุ่นกันน้ำ (Coupler Socket) AT-235 IP67



Earth contact position	6h	
Rated current (A)	63	
Pole	5	
Dimension (mm)	a	240
	b	115
	c	16-38
	d	108

รุ่น (Model)	Pole	Rated Voltage	Rated Current	สี Color	ราคา (฿)
AT-235	3P + N + E	380-415 V	63 A	Red	900 .-

เต้ารับฝัง รุ่นกันน้ำ (Panel Socket) AT-3132, AT-3232 IP67

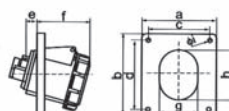

Earth contact position	6h	
Rated current (A)	16	32
Pole	3	
Dimension (mm)	a	80 80
	b	98 98
	c	60 60
	d	73 73
	e	37 45
	f	52 60
	g	57 72
	h	62 81
	i	5.5 5.5

รุ่น (Model)	Pole	Rated Voltage	Rated Current	สี Color	ราคา (฿)
AT-3132	2P + E	220-240 V	16 A	Blue	190 .-
AT-3232	2P + E	220-240 V	32 A	Blue	260 .-

Industrial Plugs, Sockets/Connectors/Insulated Clamp/MCB Flush Enclosures

เต้ารับพ่วง รุ่นกันน้ำ (Panel Socket) AT-3142, AT-3242 IP67

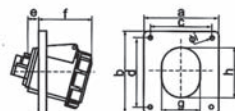

รุ่น (Model)	Pole	Rated Voltage	Rated Current	สี Color	ราคา (฿)
AT-3142	3P + E	380-415 V	16 A	Red	220 .-
AT-3242	3P + E	380-415 V	32 A	Red	290 .-

Earth contact position	6h	
Rated current (A)	16	32
Pole	4	
Dimension (mm)	a	80
	b	98
	c	60
	d	73
	e	40
	f	50
	g	63
	h	70
	i	5.5

เต้ารับพ่วง รุ่นกันน้ำ (Panel Socket) AT-3152, AT-3252 IP67



รุ่น (Model)	Pole	Rated Voltage	Rated Current	สี Color	ราคา (฿)
AT-3152	3P + N + E	380-415 V	16 A	Red	240 .-
AT-3252	3P + N + E	380-415 V	32 A	Red	340 .-

Earth contact position	6h	
Rated current (A)	16	32
Pole	4	
Dimension (mm)	a	80
	b	98
	c	60
	d	73
	e	43
	f	47
	g	70
	h	78
	i	5.5

เต้ารับพ่วง รุ่นกันน้ำ (Panel Socket) AT-4132, AT-4232 IP67



รุ่น (Model)	Pole	Rated Voltage	Rated Current	สี Color	ราคา (฿)
AT-4132	2P + E	220-240 V	16 A	Blue	210 .-
AT-4232	2P + E	220-240 V	32 A	Blue	280 .-

Earth contact position	6h	
Rated current (A)	16	32
Pole	3	
Dimension (mm)	axb	76
	cxd	61
	e	18
	f	63
	g	78
	h	46
	i	5

Industrial Plugs, Sockets/Connectors/Insulated Clamp/MCB Flush Enclosures

เต้ารับพ่วง รุ่นกันน้ำ (Panel Socket) AT-433 IP67

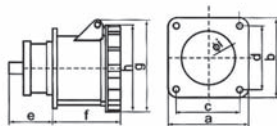

Earth contact position	6h	
Rated current (A)	63	
Pole	3	
Dimension (mm)	a	100
	b	100
	c	80
	d	80
	e	57
	f	86
	g	115
	h	109
	i	70

รุ่น (Model)	Pole	Rated Voltage	Rated Current	สี Color	ราคา (฿)
AT-433	2P + E	220-240 V	63 A	Blue	690 .-

เต้ารับพ่วง รุ่นกันน้ำ (Panel Socket) AT-4142, AT-4242 IP67



Earth contact position	6h	
Rated current (A)	16 / 32	
Pole	3	
Dimension (mm)	axb	76 / 76
	cx d	61 / 61
	e	17 / 20
	f	61 / 74
	g	84 / 98
	h	53 / 60
	i	5.5 / 5.5

รุ่น (Model)	Pole	Rated Voltage	Rated Current	สี Color	ราคา (฿)
AT-4142	3P + E	380-415 V	16 A	Red	240 .-
AT-4242	3P + E	380-415 V	32 A	Red	320 .-

บริษัท ซีที อีเลคทริค ซัพพลาย จำกัด
 CT ELECTRIC SUPPLY CO., LTD.
 โทร : 02 550 9555

เต้ารับพ่วง รุ่นกันน้ำ (Panel Socket) AT-434 IP67

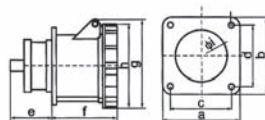

Earth contact position	6h	
Rated current (A)	63	
Pole	4	
Dimension (mm)	a	100
	b	100
	c	80
	d	80
	e	57
	f	86
	g	115
	h	109
	i	70

รุ่น (Model)	Pole	Rated Voltage	Rated Current	สี Color	ราคา (฿)
AT-434	3P + E	380-415 V	63 A	Red	750 .-

Industrial Plugs, Sockets/Connectors/Insulated Clamp/MCB Flush Enclosures

เต้ารับพ่วง รุ่นกันน้ำ (Panel Socket) AT-4152, AT-4252 IP67

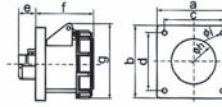

Earth contact position	6h	
Rated current (A)	16	32
Pole	5	
Dimension (mm)	axb	76
	cx d	61
	e	17
	f	62
	g	91
	h	60
	i	5.5

รุ่น (Model)	Pole	Rated Voltage	Rated Current	สี Color	ราคา (฿)
AT-4152	3P + N + E	380-415 V	16 A	Red	260 .-
AT-4252	3P + N + E	380-415 V	32 A	Red	350 .-

เต้ารับพ่วง รุ่นกันน้ำ (Panel Socket) AT-435 IP67

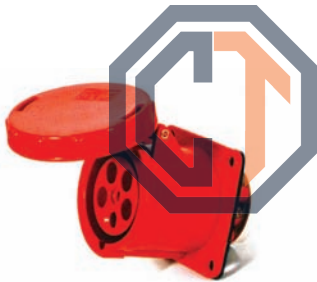

Earth contact position	6h
Rated current (A)	63
Pole	5
Dimension (mm)	a
	b
	c
	d
	e
	f
	g
	h
	i

รุ่น (Model)	Pole	Rated Voltage	Rated Current	สี Color	ราคา (฿)
AT-435	3P + N + E	380-415 V	63 A	Red	830 .-

บริษัท ซีที อิเล็กทริก ซัพพลาย จำกัด
 CTELECTRIC SUPPLY CO., LTD.
 โทร : 02 550 9555

Industrial Plugs, Sockets/Connectors/Insulated Clamp/MCB Flush Enclosures

ปลั๊กไฟฟ้า 2 ทาบ AT-1012 IP44

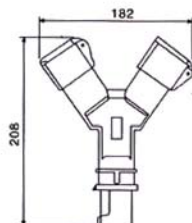

Earth contact position	6h
Rated current (A)	16
Pole	2
Dimension (mm)	

รุ่น (Model)	Pole	Rated Voltage	Rated Current	สี Color	ราคา (฿)
AT-1012	2P+E	220 V	16 A	Blue	660.-

ปลั๊กไฟฟ้า 3 ทาบ AT-1013 IP44

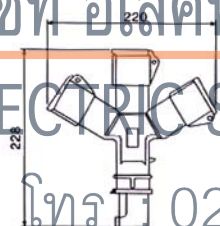

Earth contact position	6h
Rated current (A)	16
Pole	2
Dimension (mm)	

รุ่น (Model)	Pole	Rated Voltage	Rated Current	สี Color	ราคา (฿)
AT-1013	2P+E	220 V	16 A	Blue	820.-

ปลั๊กไฟฟ้า 3 ทาบ AT-1014 IP44

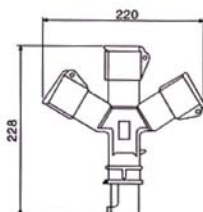

Earth contact position	6h
Rated current (A)	
Pole	
Dimension (mm)	

รุ่น (Model)	Pole	Rated Voltage	Rated Current	สี Color	ราคา (฿)
AT-1014	3P+E	380 V	16 A	Red	1,200.-

Wiring Component

วามาร์คเกอร์ชนิดร้อยสาย

วามาร์คเกอร์ชนิดร้อยสาย รุ่น EC-1, EC-2 วามาร์คเกอร์ PVC สีเหลือง ตัวหนังสือสีดำใช้สำหรับกำหนดปลายสายไฟในตู้คอนโทรล ชนิดร้อยสาย ทั้งม้วนมีหมายเลขเดียวกันทั้งม้วน

- T : Tupe Cable Marker
- Marker tongue spans to fit various cable diameters and tetracts to hold wires firmly in position
Maximum service temperature 85°C
 - Msaterial
 - Made of finest soft grade, strong, durable P.V.C. that will resist oil, grease, acid, abrasion and chemicals.
- Description
- EC type cable marker features high quality flexible interior to fit various cable diameters.
 - The markers stay attached on a roller and can be despatched easily when needed.
 - Bold print on yellow body to show your codes distinguishly. Any numbers can be composed by arranging letters and numbers in sequence to provide the necessary codes.
 - To be fitted before the terminal is attached or solder connection made and grip cables firmly in position.

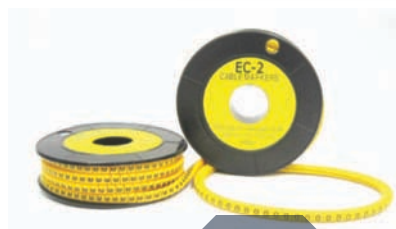

Type No. (รุ่น)	Approx wire size Sq. mm	Wire Dia. mm.	Markers Lable ตัวอักษร	Qty./Rell จำนวนตัว/ม้วน	Price @ ราคาม้วนละ
EC-1	0.75-3.5 mm.	2.6-4.2 mm.	0,1,2,3.....9	1,000 PCS.	75 .-
EC-2	3.5-8.0 mm.	4.0-6.5 mm.	A,B,C.....Z,+,-	500 PCS.	75 .-

Spiral Wrapping Band

ใช้ใ้แก่สำหรับรัดสายไฟ



บริษัท ซีที อิเล็กทริก ซัพพลาย จำกัด CT ELECTRIC SUPPLY CO., LTD.

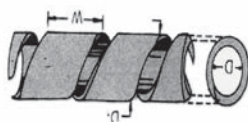
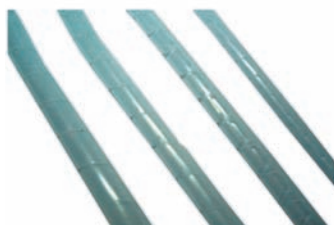

ใ้แก่สำหรับรัดสายไฟ

รุ่น (Model)	Wrapping Range (mm.)	Dimension (mm.)	บรรจุ/ม้วน (เมตร)	ราคา/ม้วน (฿)
SW-06	10-15	4 x 6 x 7.0 (D x D1 x w)	10	54 .-
SW-08	15-60	6 x 8 x 10.8 (D x D1 x w)		70 .-
SW-10	20-60	7.5 x 10 x 11.4 (D x D1 x w)		75 .-
SW-12	20-65	9 x 12 x 13.9 (D x D1 x w)		90 .-
SW-16	20-70	12 x 15 x 15.0 (D x D1 x w)		105 .-
SW-20	25-100	15 x 19 x 18.2 (D x D1 x w)		180 .-
SW-25	30-130	20 x 24 x 19.6 (D x D1 x w)		280 .-

Terminal Block

เต้าต่อสาย



เต้าต่อสาย

รุ่น (Model)	Clamping Area (mm ²)	Wire Range AWG (Cu.)	Scraw	บรรจุ/ม้วน (เมตร)	ราคา/เส้น (฿)
ลูกเต้า 3A	2.5	22-12 Sol./Str.	M2.6x6	50 PCS.	N/A
ลูกเต้า 5A	4.0	22-12 Sol./Str.	M2.6x6	50 PCS.	N/A
ลูกเต้า 10A	6.0	22-10 Sol. 14-10 Str.	M3.0x6	50 PCS.	N/A
ลูกเต้า 15A	10.0	22-10 Sol./Str.	M3.5x7	40 PCS.	N/A

Cable-Ties

- Available in wide range of materials.
- Internal serrations allowing for a positive hold onto cable and pipe bundles.
- The design of the head guarantees a high tensile strength while allowing a very low insertion force.
- Fire-resistant, Heat-resistant, UV resistant are available.
- Material : Polyamide 6, 6 UL94 V2

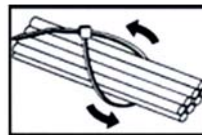
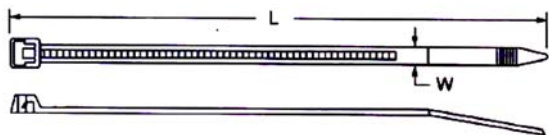

ง่ายต่อการหยิบจับสอดรัดได้เร็วขึ้น มีร่องปานาน ปลายโค้งเรียวยาว

ป้องกันการสั่นหลุดมือ ง่ายต่อการหยิบจับสอดรัดเมื่อใช้งาน มีคุณภาพตามมาตรฐานกำหนด

Cable-Ties เข็มขัดรัดสาย

Item No. (รุ่น)		ความยาว Length. (L)		กว้าง Width (W)	เส้นผ่าศูนย์กลาง Max.Bundle Dia	ค่าการต้านทานแรงดึง Min.Loop Tensile Strength	จำนวนบรรจุ/ถุง/ลัง Packaging.	ราคา/ถุง Price 100 เส้น /ถุง
สีขาว NATURE COLOR	สีดำ BLACK COLOR	mm.	inch.	mm.	mm.	kg (lbs)		
AT-100MN	AT-100MB	100	4"	2.5	Ø 22	8.1 (18)	550	16 .-
AT-150IN	AT-150IB	150	6"	3.6	Ø 35	18.2 (40)	250	45 .-
AT-200IN	AT-200IB	200	8"	3.6	Ø 38	18.2 (40)	200	60 .-
AT-200STN	AT-200STB	200	8"	4.8	Ø 50	22.2 (50)	160	72 .-
AT-300STN	AT-300STB	300	12"	4.8	Ø 76	22.2 (50)	110	148 .-
AT-370STN	AT-370STB	370	14.5"	4.8	Ø 102	22.2 (50)	90	253 .-

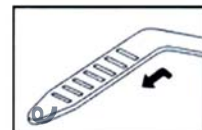
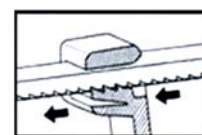

Pressure Clips & Plastic Cable Gland with Ring โทร : 02 550 9555



เคเบิลกลนพลาสติก



เพรสเชอร์ คลิป

เคเบิลกลนพลาสติก (Plastic Cable Gland with Ring)

รุ่น (Model)	Thead (mm.)	ใช้กับสายขนาด	บรรจุ กล่องละ	ราคา (฿)
250/7	PG.7	6-3.5 MCM	200	12 .-
250/9	PG.9	7-4.5 MCM	150	12 .-
250/11	PG.11	9-6 MCM	100	12.50 .-
250/13	PG.13.5	12-9 MCM	75	13.50 .-
250/16	PG.16	14-11 MCM	50	14 .-
250/21	PG.21	18-14 MCM	30	24 .-
250/29	PG.29	25-18 MCM	16	50 .-
250/36	PG.36	32-25 MCM	6	100 .-
250/42	PG.42	38-30 MCM	5	220 .-
250/48	PG.48	42-34 MCM	4	300 .-

เคเบิลกลนพลาสติก (Plastic Cable Gland with Ring)

รุ่น (Model)	ใช้กับสายขนาด	บรรจุ กล่องละ	ราคา (฿)
1766	6-16 mm.	100	4.25 .-
1767	16-24 mm.	50	8.25 .-
1768	24-34 mm.	25	21 .-



แป้นกาว

รุ่น (Model)	Length mm	Width mm	High mm	Hole mm	Tile hole mm	ราคา/ถุงละ (฿)
ATM-3AW	19	19	3.5	4.0	4.7	280 .-
ATM-3AB	19	19	3.5	4.0	4.7	280 .-
ATM-4AW	28	28	4.0	5.0	50	480 .-
ATM-4AB	28	28	4.0	5.0	50	480 .-

เคเบิลแกล้ม

รุ่น (Model)	E (mm)	A (mm)	B (mm)	C (mm)	D (mm)	ราคา/ตัว (฿)
CC-1/8 (Ø 1/8")	3.3	8.2	9.1	1.27	5.45	1.54
CC-3/16 (Ø 3/16")	4.8	9.6	9.1	1.27	5.45	1.68
CC-1/4 (Ø 1/4")	6.6	10.3	9.1	1.27	5.45	1.68
CC-5/16 (Ø 5/16")	7.8	10.3	9.1	1.27	5.45	1.68
CC-3/8 (Ø 3/8")	9.1	13.4	12.1	1.5	5.3	1.82
CC-1/2 (Ø 1/2")	12.2	15.0	12.7	1.5	5.3	2.10
CC-5/8 (Ø 5/8")	-	-	-	-	-	2.24
CC-3/4 (Ø 3/4")	18.6	19.8	12.7	1.5	5.3	2.65
CC-1 (Ø 1")	-	-	-	-	-	3.22
CC-1-1/16 (Ø 1-1/16")	-	-	-	-	-	3.32
CC-1-1/4 (Ø 1-1/4")	-	-	-	-	-	3.36
CC-1-1/2 (Ø 1-1/2")	-	-	-	-	-	3.92



บริษัท ซีที อิเล็กทริก ซัพพลาย จำกัด
CT ELECTRIC SUPPLY CO., LTD.

แป้นกาวเคเบิลแกล้ม

รุ่น (Model)	Length mm	Width mm	High mm	Hole mm	Tile hole mm	ราคา/ตัว (฿)
NAP-08-WHITE	-	-	-	-	-	4.8 .-
NAP-09-WHITE	-	-	-	-	-	6.6 .-
NAP-22-WHITE	-	-	-	-	-	16.50 .-

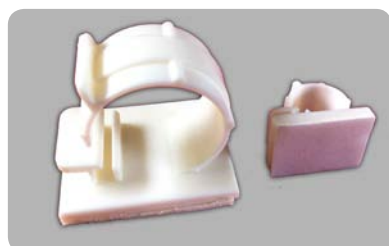

แป้นกาวอลูมิเนียม (Aluminium Self-adhesive Clips)

รุ่น (Model)	Length mm	Width mm	High mm	Hole mm	Tile hole mm	ราคา/ตัว (฿)
ALACO-01 Open Arm type	-	-	-	-	-	4.8 .-
ALACO-02	-	-	-	-	-	6.8 .-
ALACA-01 Open Arm type	-	-	-	-	-	8.50 .-
ALACA-02	-	-	-	-	-	8.80 .-
ALACA-03	-	-	-	-	-	9.15 .-
ALACA-04	-	-	-	-	-	9.70 .-
ALACA-05	-	-	-	-	-	11 .-
ALACA-06	-	-	-	-	-	12.20 .-
ALACA-07	-	-	-	-	-	12.70 .-
ALACB-01 Buckle Type	-	-	-	-	-	8.85 .-
ALACB-02	-	-	-	-	-	11.20 .-
ALACH-01 Hook Type	-	-	-	-	-	28 .-

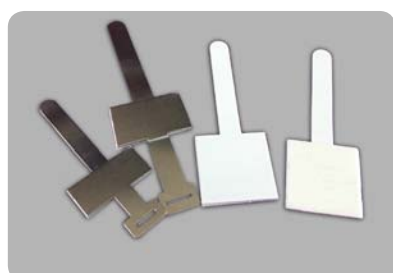
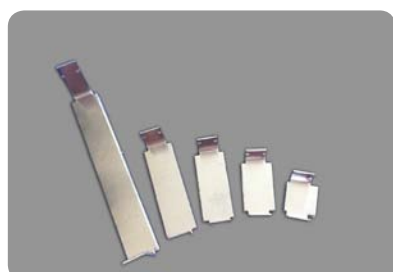

Terminal Block

รุ่น TB-2503

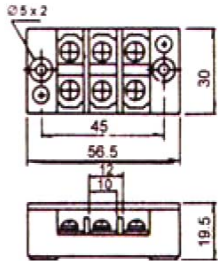

รุ่น TB-2504

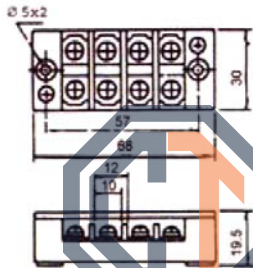

รุ่น TB-2506

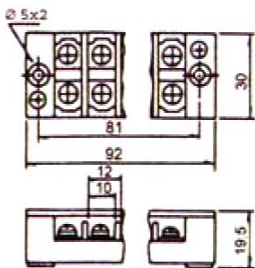

รุ่น TB-2512

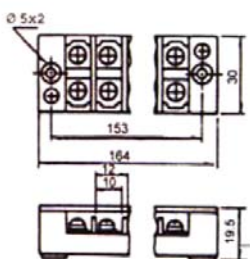

TB25-Type

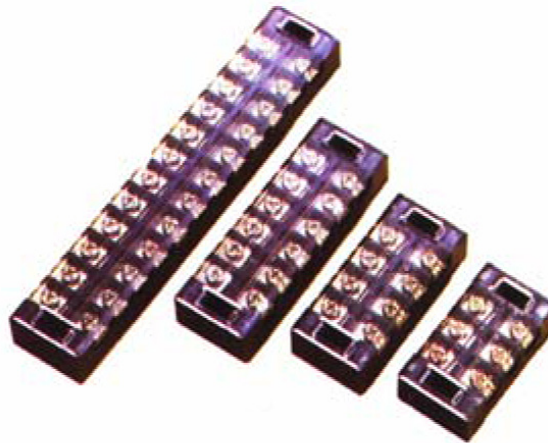

รุ่น TC-60A/3P



รุ่น TC-300A/4P



บริษัท ซีที อิเล็กทริก ซัพพลาย จำกัด

CT ELECTRIC SUPPLY CO., LTD.

รุ่น (Model)	Pole	Rated Current	USST ทุกรุ่น	ราคา (฿)
TB-2503	3	25 A	50	26 .-
TB-2504	4	25 A	50	32 .-
TB-2506	6	25 A	50	40 .-
TB-2512	12	25 A	50	62 .-
TC-60A/3P	3	60 A	-	105 .-
TC-100A/3P	3	100 A	-	250 .-
TC-150A/3P	3	150 A	-	300 .-
TC-200A/3P	3	200 A	-	400 .-
TC-300A/3P	3	300 A	-	660 .-
TC-400A/3P	3	400 A	-	1,000 .-
TC-60A/4P	4	60 A	-	140 .-
TC-100A/4P	4	100 A	-	300 .-
TC-150A/4P	4	150 A	-	400 .-
TC-200A/4P	4	200 A	-	535 .-
TC-300A/4P	4	300 A	-	880 .-
TC-400A/4P	4	400 A	-	1,300 .-

Terminal Block

เทอร์มินอล บล็อก



รุ่น (Model)	SAK-2.5/35	SAK-4/35	SAK-6/35	SAK-10/35	SAK-16/35
Item Code	0802535	0804035	0806035	0810035	0816035
Outline Demension					
Width/thickness/Highness (mm)	40/6/38.5	40/6.5/52	42/8/52	40/10/52	40/12/52
Bolt Diameter (mm)	M2.5 (Bolt)	M3 (Bolt)	M3.5 (Bolt)	M4 (Bolt)	M4 (Bolt)
Toggle Distance (mm)	0.4-0.8	0.5-1.0	0.8-1.6	2.0-2.4	2.0-2.4
Exhausted line length (mm)	10	12	12	12	15
Rated Data					
Voltage/Current (V)(A)	800V/24A	800V/32A	800V/41A	800V/57A	800V/76A
Ated Working Frequency	2.5KV	2.5KV	2.5KV	2.5KV	2.5KV
Duralbe Foltage (A)					
Cross-sectional Area (mm ²)	2.5 mm ²	4 mm ²	6 mm ²	10 mm ²	16 mm ²
ราคา (฿)	20 .-	23 .-	28 .-	38 .-	48 .-

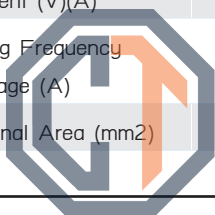

บริษัท ซีที อิเล็กทริก ซัพพลาย จำกัด
CT ELECTRIC SUPPLY CO., LTD.

โทร : 02 550 9555



รุ่น (Model)	SAK-35/35	SAK-70EN	SAK-4/35S1	SAK-W16/1	SAK-RD	EW-35 Fixed Parts
Item Code	0835035	0870010	0804351	0805161	0800560	0800035
Outline Demension						
Width/thickness/Highness (mm)	50/18/63.3	75/22/87	54/6/60.5	65/8/48.5	58/6/48.5	
Bolt Diameter (mm)	M6 (Bolt)	M6 (Bolt)	M3 (Bolt)	M3.5 (Bolt)	M3 (Bolt)	
Toggle Distance (mm)	2.5-5.0		0.5-1.0	0.8-1.6	0.5-0.7	
Exhausted line length (mm)	20	22	12	12	10	
Rated Data						
Voltage/Current (V)(A)	800V/125A	800V/192A	600V/32A	400V/41A	500V/6.3A	
Ated Working Frequency	2.5KV	3.0KV	2.5KV	2.5KV	6.3KV	
Duralbe Foltage (A)						
Cross-sectional Area (mm ²)	35 mm ²	70 mm ²	4 mm ²	6 mm ²	4 mm ²	
ราคา (฿)	90 .-	180 .-	55 .-	120 .-	85 .-	20 .-

Terminal Block

เทอร์มินอล บล็อก

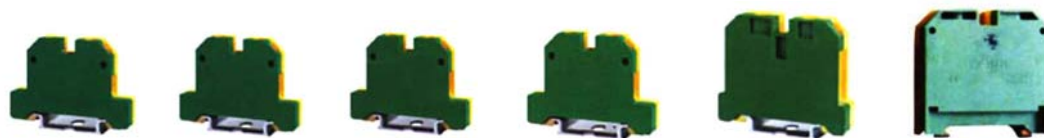

รุ่น (Model)	EK 2.5/35	EK 4/35	EK 6/35	EK 10/35	EK 16/35	EK 35/35
Item Code						
Outline Demension						
Width/thickness/Highness (mm)						
Bolt Diameter (mm)						
Toggle Distance (mm)						
Exhausted line length (mm)						
Rated Data						
Voltage/Current (V)(A)						
Ated Working Frequency						
Duralbe Foltage (A)						
Cross-sectional Area (mm2)						
ราคา (฿)	60 .-	70 .-	80 .-	95 .-	100 .-	160 .-

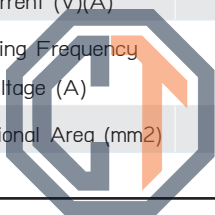

บริษัท ซีที อิเล็กทริก ซัพพลาย จำกัด
 CT ELECTRIC SUPPLY CO., LTD.

โทร : 02 550 9555



รุ่น (Model)	AP-4-10	AP-16	AP-35	AP-70	AP-4/35S1	AP-W16
Item Code						
Outline Demension						
Width/thickness/Highness (mm)						
Bolt Diameter (mm)						
Toggle Distance (mm)						
Exhausted line length (mm)						
Rated Data						
Voltage/Current (V)(A)						
Ated Working Frequency						
Duralbe Foltage (A)						
Cross-sectional Area (mm2)						
ราคา (฿)	8 .-	13 .-	25 .-	30 .-	20 .-	20 .-

TBR Series Terminal Block

TBR-10A



TBR-20A



TBR-60A



TBR-30A



TBR-100A



รุ่น (Model)	Wire Section	Rated Current/ Voltage	Thick/Wide/ High	ราคา (฿)
TBR-10A END COVER TBR-10A	0.75-1.5 mm ²	10A/600V	9/42/33 mm	9 .- 4.75 .-
TBR-20A END COVER TBR-20A	1.5-2.5 mm ²	20A/600V	11/42/33 mm	11 .- 4.75 .-
TBR-30A END COVER TBR-30A	2.5-4 mm ²	30A/600V	13/42/33 mm	17 .- 5.50 .-
TBR-60A END COVER TBR-60A	4-10 mm ²	60A/600V	15/42/33 mm	26 .- 8 .-
TBR-100A END COVER TBR-100A	-	100A/600V	-	58 .- 11 .-

รางอลูมิเนียม (Mounting Chanel) รางรีเลย์

ความยาว เส้นละ 1 เมตร

ราคา 75 บาท

แผ่นเหล็กปิดหน้า-หลัง (Stopper) สติ๊ปปเปอร์รีเลย์

รุ่น BNL5-N

ราคา 15 บาท

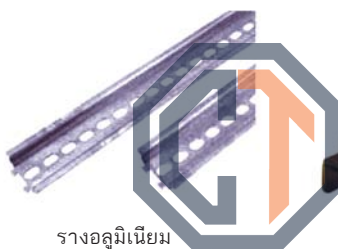

รางอลูมิเนียม

BNL5-N

เทอร์มินอล TR-Series 600V_{AC}

รุ่น (Model)	Rated Current	Wire (mm ²)	Terminal Screw	USRJ กล่องละ:	ราคา (฿)
TR-10	10A	2.5	M 3.5	120	8 .-
TR-20	20A	4	M 4	120	10 .-
TR-30	30A	6	M 5	60	15 .-
TR-60	60A	25	M 6	10	24 .-
TR-100	100A	50	M 8	6	50 .-
TR-200	200A	120	M 10	3	115 .-

ฝาปิดท้ายเทอร์มินอล (End-plate Unit)

รุ่น (Model)	Size (mm.)	USRJ กล่องละ:	ราคา (฿)
TRA-1	2.6	10	4.50 .-
TRA-2	2.6	10	4.75 .-
TRA-3	3.2	10	5.25 .-
TRA-6	3.3	5	7.50 .-
TRA-10	4	5	11 .-

รางอลูมิเนียม (Mounting Chanel) รางเทอร์มินอล

ความยาว เส้นละ 1 เมตร

ราคา 75 บาท

แผ่นเหล็กปิดหน้า-หลัง (Stopper) สติ๊ปปเปอร์เทอร์มินอล

รุ่น TRE-1

ราคา 4.50 บาท

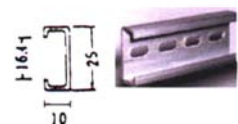

รางอลูมิเนียม

แผ่นเหล็กปิดหน้า-หลัง

TRA-10 TRA-6 TRA-3 TRA-2 TRA-1
ฝาปิดท้ายเทอร์มินอล

Cassette Assembly Terminal Block

TBC-10A

Price 8 .-

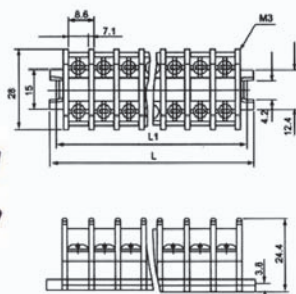

END COVER TBC-10A

Price 4.50 .-



TBC-20A

Price 10 .-

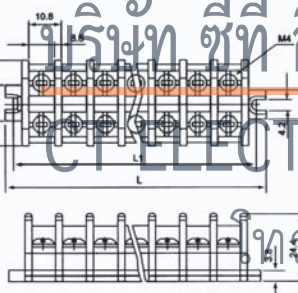

END COVER TBC-20A

Price 4.75 .-

TBC-30A

Price 16 .-

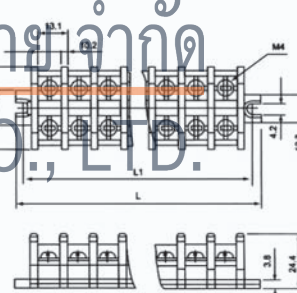

END COVER TBC-30A

Price 5.25 .-

TBC-60A

Price 25 .-

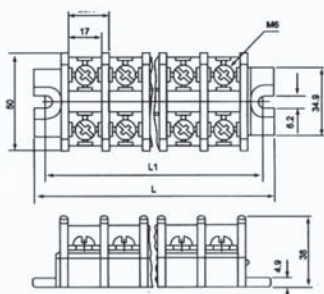

END COVER TBC-60A

Price 7.50 .-

TBC-100A

Price 55 .-

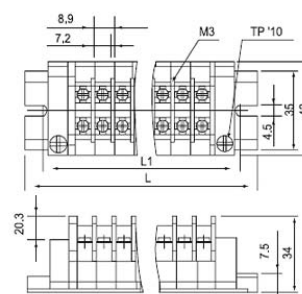

END COVER TBC-100A

Price 11 .-

Bus-Bar Insulators



รุ่น (Model)	ราคา (฿)
AT-30	20 .-
AT-35	25 .-
AT-40	50 .-
AT-45	55 .-
AT-51	50 .-
AT-60	80 .-
AT-76	90 .-

AT-30

伸缩强度(LBS)	550
Tensile strength(LBS)	550
耐压(KV)	8
Voltage withstand(KV)	8
扭距(FT LBS)	8
Torgue strength(FT LBS)	8
螺纹(mm)	8
screw(mm)	8
螺纹深度(mm)	11
screw depth(mm)	11

AT-35

伸缩强度(LBS)	600
Tensile strength(LBS)	600
耐压(KV)	10
Voltage withstand(KV)	10
扭距(FT LBS)	10
Torgue strength(FT LBS)	10
螺纹(mm)	8
screw(mm)	8
螺纹深度(mm)	11
screw depth(mm)	11

AT-40

伸缩强度(LBS)	650
Tensile strength(LBS)	650
耐压(KV)	12
Voltage withstand(KV)	12
扭距(FT LBS)	12
Torgue strength(FT LBS)	12
螺纹(mm)	8
screw(mm)	8
螺纹深度(mm)	11
screw depth(mm)	11

AT-45

伸缩强度(LBS)	1000
Tensile strength(LBS)	1000
耐压(KV)	14
Voltage withstand(KV)	14
扭距(FT LBS)	20
Torgue strength(FT LBS)	20
螺纹(mm)	8
screw(mm)	8
螺纹深度(mm)	11
screw depth(mm)	11

AT-51

伸缩强度(LBS)	1000
Tensile strength(LBS)	1000
耐压(KV)	15
Voltage withstand(KV)	15
扭距(FT LBS)	20
Torgue strength(FT LBS)	20
螺纹(mm)	8
screw(mm)	8
螺纹深度(mm)	14
screw depth(mm)	14

AT-60

伸缩强度(LBS)	1200
Tensile strength(LBS)	1200
耐压(KV)	20
Voltage withstand(KV)	20
扭距(FT LBS)	35
Torgue strength(FT LBS)	35
螺纹(mm)	10
screw(mm)	10
螺纹深度(mm)	15
screw depth(mm)	15

AT-76

伸缩强度(LBS)	1500
Tensile strength(LBS)	1500
耐压(KV)	25
Voltage withstand(KV)	25
扭距(FT LBS)	40
Torgue strength(FT LBS)	40
螺纹(mm)	10
screw(mm)	10
螺纹深度(mm)	20
screw depth(mm)	20

Step Insulators

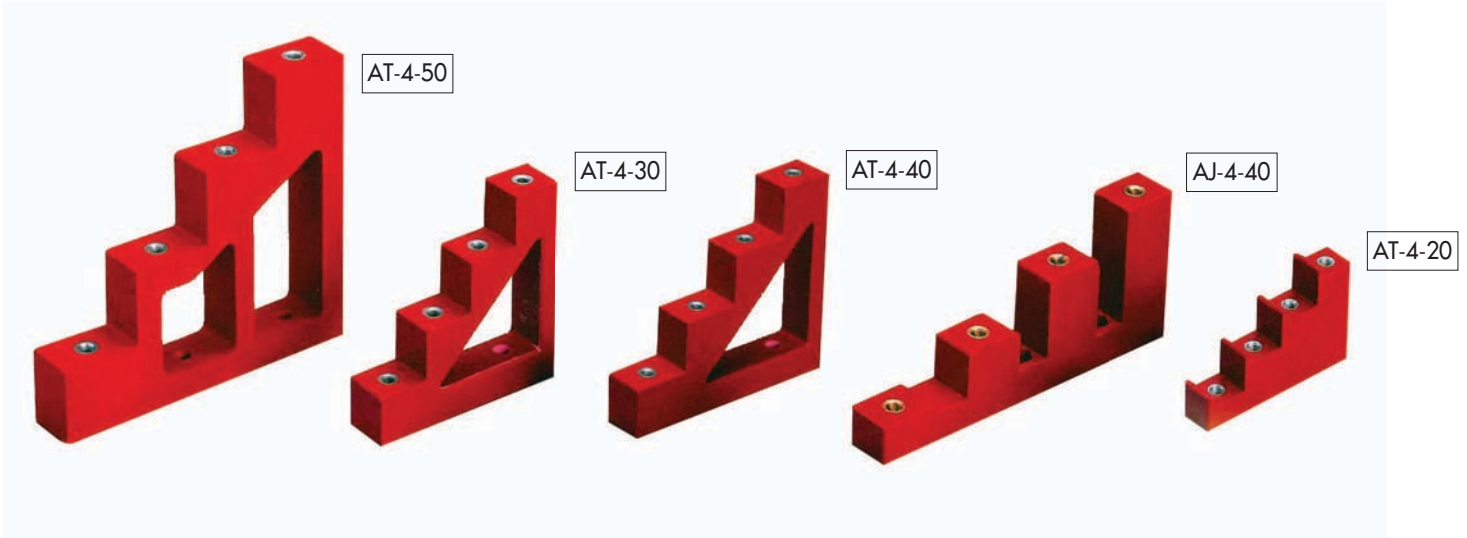

รุ่น (Model)	ราคา (฿)
AT-4-20	170.-
AJ-4-40	350.-
AT-4-30	320.-
AT-4-40	350.-
AT-4-50	500.-

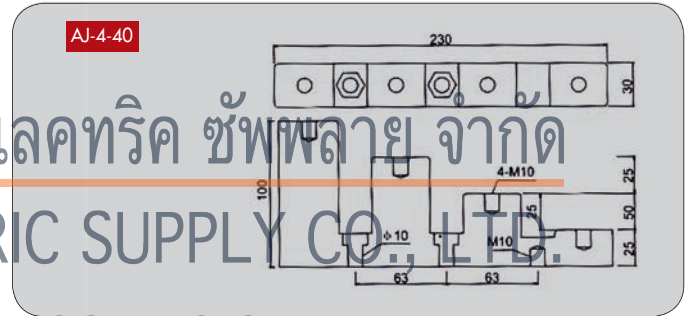

โทร : 02 550 9555

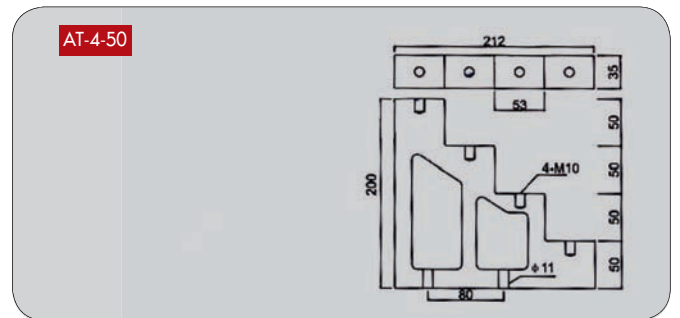
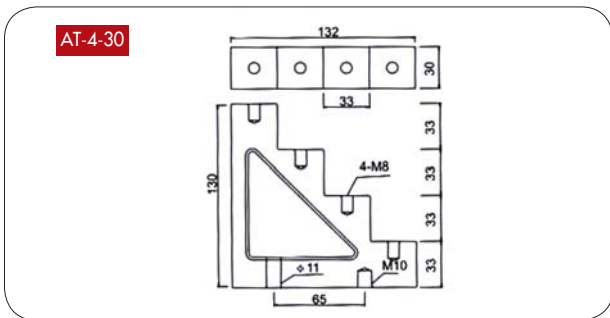
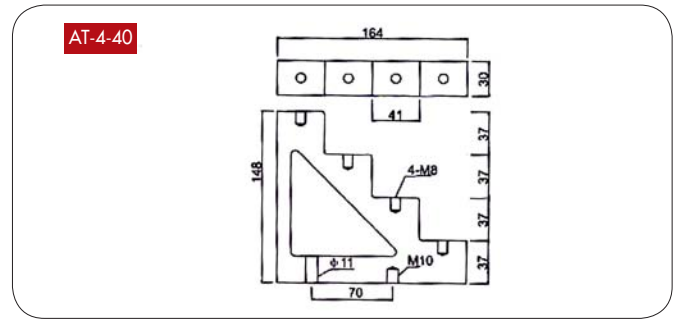
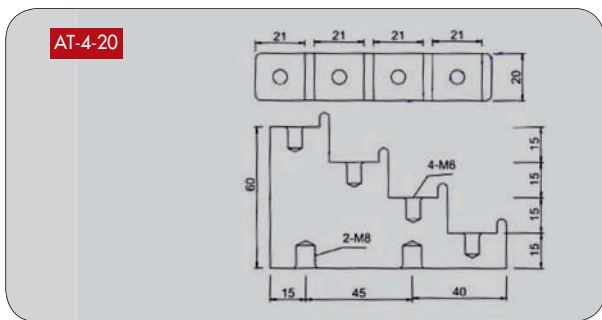

Bus-Bar Supports

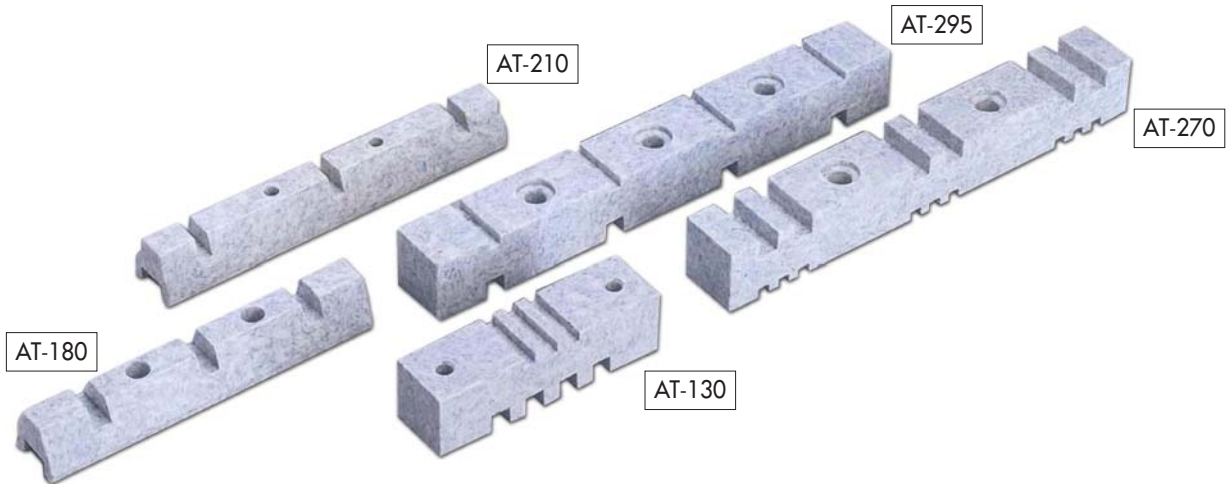

รุ่น (Model)	ราคา/ตัว (฿)
AT-130	220 .-
AT-155	300 .-
AT-170	140 .-
AT-180	140 .-
AT-210	155 .-
AT-270	350 .-
AT-295	450 .-

AT-130

Dimension Number	A	B
1	11	
2	10	6.5
3	7	
4	6	
5	5	

บริษัท ซีที อิเล็กทริค ซัพพลาย จำกัด
CT ELECTRIC SUPPLY CO., LTD.
 โทร : 02 550 9555

AT-155

Dimension Number	A
1	6
2	7

AT-170

Dimension Number	A	B
1	12	7
2	12	0
3	11	6
4	10	5

AT-180

SIZE No.	A
1	7
2	11

AT-210

	A	B	C	D	W
2	28	18	10	7	7.5
3	28	18	10	7	11.5
4	28	18	10	7	10
12	31	21	13	10	7.5
13	31	21	13	10	11.5
14	31	21	13	10	10

AT-270

Dimension Number	A	B
1	12	7
2	12	0
3	11	6
4	10	5

AT-295

Dimension Number	A	B
1	11	-
2	22	-
3	5	-
4	6.3	-
5	11	6.3

Bus-Bar Supports



รุ่น (Model)	ราคา/ตัว (฿)
AT-409	600 .-
AT-500	950 .-
AT-600	1,000 .-
AT-800	2,000 .-
AT-100	155 .-
AT-125	180 .-



บริษัท ซีที อิเล็กทริก ซัพพลาย จำกัด

CT ELECTRIC SUPPLY CO., LTD.

โทร : 02-550-9555

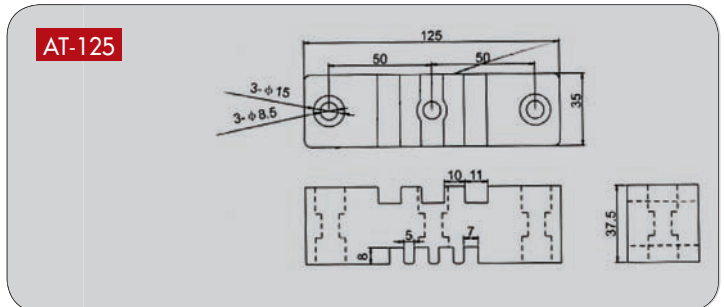
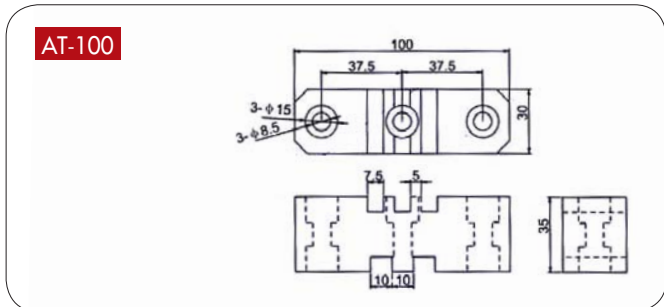
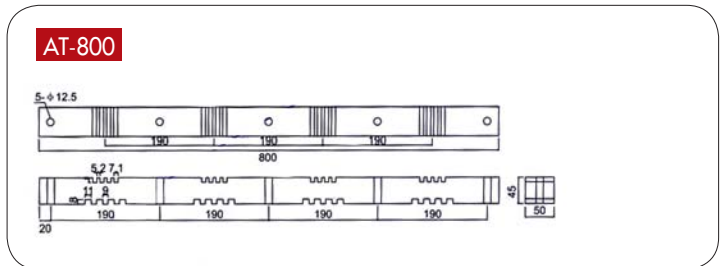
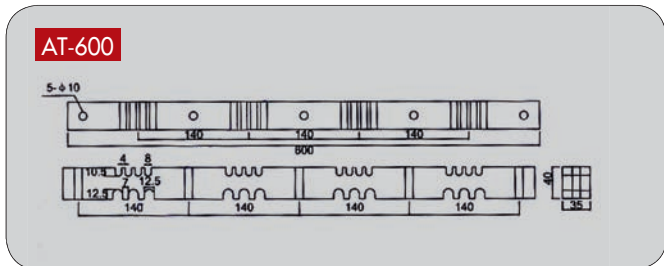
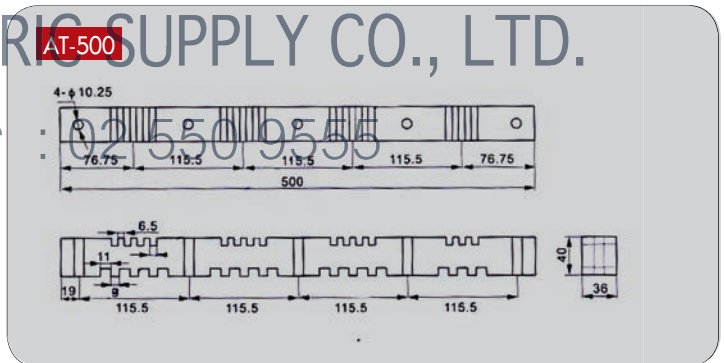
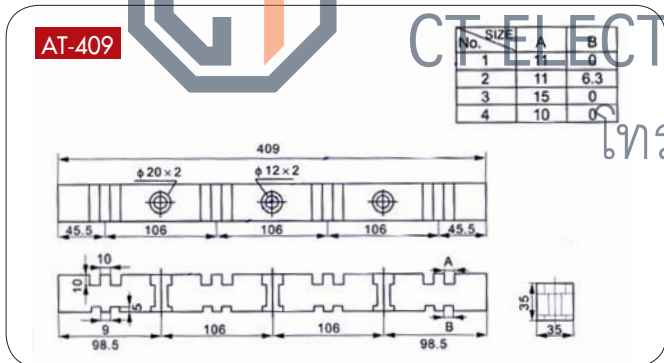

Mini Warning Light

Mini Warning Light

LTE 1102, LTE 1122



LTE 1102J (Buzzer)



LTE 1101

ไฟสัญญาณชนิดหมุน

รุ่น (Model)	Voltage		Color	ราคา (฿)
	AC	DC		
LTE 1102 ชนิดหมุน	110, 220V	12V, 24V	R, Y, G, BL	600 .-
LTE 1122 Flashing ชนิดหมุน	110, 220V	12V, 24V	R, Y, G, BL	950 .-
LTE 1101 ชนิดหมุน	110, 220V	12V, 24V	R, Y, G, BL	565 .-
LTE 1102J (Buzzer) ชนิดหมุน มีเสียง	110, 220V	12V, 24V	R, Y, G, BL	850 .-

Signal Tower

Signal Tower Ø 55

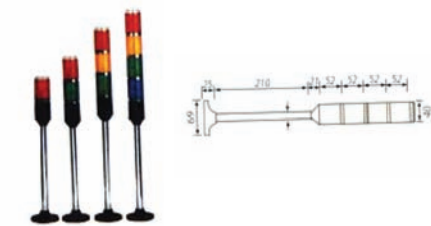

บริษัท ซีที อีเลคทริก ซัพพลาย จำกัด

CT ELECTRIC SUPPLY CO., LTD.

โทร: 02-550 9555

รุ่น (Model)	Voltage	Color	Light Power	T-Steady Burn Price (ไม่กระพริบ)	W-Flash Price (กระพริบ)
LTA205-1		R	2W	1,050 .-	1,550 .-
LTA205-2	DC12V	R-G	4W	1,450 .-	1,900 .-
LTA205-3	DC24V	R-Y-G	6W	1,850 .-	2,350 .-
LTA205-4	AC110V	R-Y-G-BL	8W	2,450 .-	2,850 .-
LTA205-5	AC220V	R-Y-G-BL-W	10W	3,050 .-	3,450 .-

รุ่น (Model)	Voltage	Light Power	TJ-Steady Burn With Buzzer Price (ไม่กระพริบ มีเสียง)	WJ-Flash With Buzzer Price (กระพริบ มีเสียง)
LTA205-1		2W	1,450 .-	2,200 .-
LTA205-2	DC12V	4W	2,050 .-	2,750 .-
LTA205-3	DC24V	6W	2,550 .-	3,250 .-
LTA205-4	AC110V	8W	3,150 .-	3,750 .-
LTA205-5	AC220V	10W	3,650 .-	4,350 .-

ลูกรอก



ลูกรอก 4 หุน

ลูกรอก 6 หุน

รุ่น (Model)	รายละเอียด	บรรจุกล่องละ	ราคาตัวละ (฿)
ลูกรอก 4 หุน		200	20 .-
ลูกรอก 6 หุน		200	30 .-

Power Relay Socket Relay

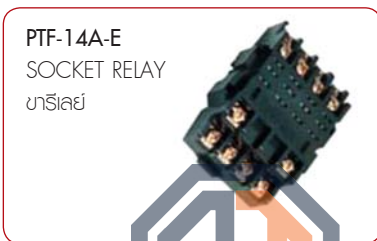

บริษัท ซีที อิเล็กทริก ซัพพลาย จำกัด
CT ELECTRIC SUPPLY CO., LTD.

เพาเวอร์รีเลย์ (Power Relay)

รุ่น (Model)	Socket	Contact (Form)	Rated Voltage		Contact Rating	USRG กล่องละ	ราคา (฿)
			VAC	VDC			
MK2P-I	PF-083A, A-E	DPDT	110, 220	24	10 A	20	125 .-
MK3P-I	PF-113A-E	3PDT			10 A	20	160 .-
MY2N	PYF-08A-E	DPDT			3 A/5 A	50	100 .-
MY4N	PYF-14A-E	4PDT			3 A/5 A	50	106 .-

ขาเรียลย์ (Track Mounted Sockets)

รุ่น (Model)	Pins	USRG กล่องละ	ราคา (฿)
PF-083A, PF-083A-E	8 Pins	20	40, 45 .-
PF-113A-E	11 Pins	20	45 .-
PYF-08A-E	8 Pins	20	50 .-
PYF-14A-E	14 Pins	20	55 .-
PTF-08A-E	8 Pins	50	55 .-
PTF-14A-E	14 Pins	50	120 .-

Timer

AH3-1/2/3



AH3-N						
รุ่น (Model)	ช่วงการตั้งเวลา	Rated Voltage	ชนิดและคุณสมบัติหน้าสัมผัสของเอาท์พุท	Socket	ราคา (฿) (รวมช้อคเกิต)	
AH3-A	1S, 10S, 1M, 10M	220 ac	MODE DPDT, SPDT 5A 250V	PF083A-E	480 .-	
AH3-B	3S, 30S, 3M, 30M					
AH3-C	6S, 60S, 6M, 60M					
AH3-D	1M, 10M, 1H, 10H					
AH3-E	3M, 30M, 3H, 30H					

Moter Siren

MS-190



มอเตอร์ไซเรน (Motor Siren)						
รุ่น (Model)	Rated Voltage	Rated Current	Power (W)	Power dBA	Speed RPM	ราคา (฿)
MS-190	DC24 V	1.55 A	38 W	95-100db	4000-4200	500 .-
MS-190	AC220 V	0.20 A	45 W	95-100db	4600-4800	500 .-

MS-290

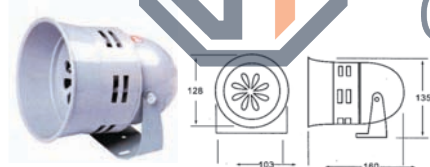

มอเตอร์ไซเรน (Motor Siren)						
รุ่น (Model)	Rated Voltage	Rated Current	Power (W)	Power dBA	Speed RPM	ราคา (฿)
MS-290	AC220 V	0.375 A	80 W	100-105db	5900-6200	800 .-

MS-390

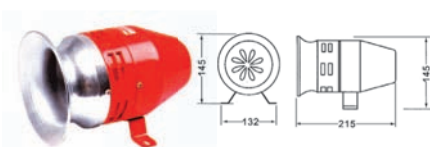

มอเตอร์ไซเรน (Motor Siren)						
รุ่น (Model)	Rated Voltage	Rated Current	Power (W)	Power dBA	Speed RPM	ราคา (฿)
MS-390	AC220 V	0.68 A	150 W	110-115db	7400-7600	1,850 .-

COLLING Fan Series

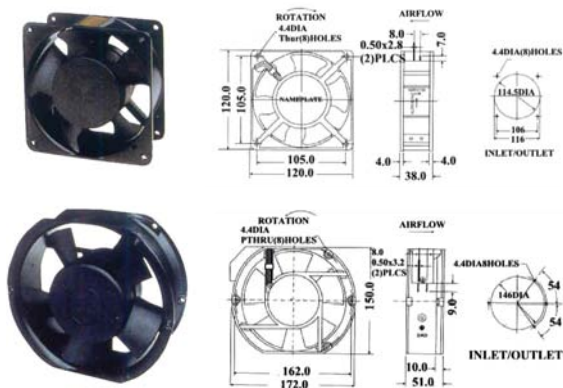

พัดลมดูดอากาศ						
รุ่น (Model)	ขนาด (Size/mm)	Rated Voltage	Airflow	Weight	Noise	ราคา (฿)
RC120 - 38 M/B	120x120x38	230V	122-162 m ³ /hr 72-95 CFM	480 g	39 - 48dBA	480 .-
RC150 - 52 M/B	150x170x52	230V	272-336 m ³ /hr 160-198 CFM	860 g	49 - 59dBA	900 .-

Alarm Bell



CB-4B



CB-6B



CB-8B



CB-10B

Model (รุ่น)	Outer Size	Voltage	ราคา (฿)
CB-4B		AC 220 V	250 .-
CB-6B			500 .-
CB-8B			650 .-
CB-10B			850 .-

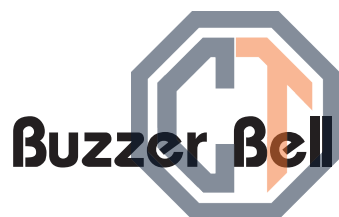

Buzzer Bell Siren

บริษัท ซีที อิเล็กทริก ซัพพลาย จำกัด

CT ELECTRIC SUPPLY CO., LTD.

โทร : 02 550 9555



EBL-1



EBL-2

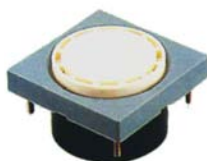

EBL-3

ออกไซเรน

รุ่น (Model)	Rated Voltage	Power dBA	ราคา (฿)
EBL-1 (ออกผึ้ง)	AC110 V, AC220 V,	40 db	250 .-
	DC12 V, DC24 V,		290 .-
EBL-2 (ออกलय)	AC110 V, AC220 V,	80 db	210 .-
	DC12 V, DC24 V,		310 .-
EBL-3 (ออกผึ้ง)	AC110 V, AC220 V,	80 db	300 .-
	DC12 V, DC24 V,		340 .-

Foot Switch

Features

- Metal series shell
- Plastic series shell

Contact From

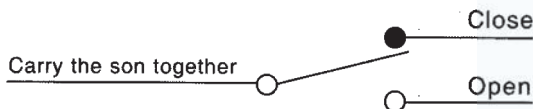

บริษัท ซีที อิเล็กทริก ซัพพลาย จำกัด

Features

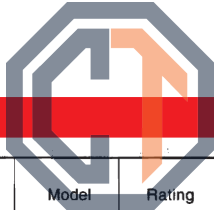

CT ELECTRIC SUPPLY CO., LTD.

Designation	Model	Rating	Type of switch enclosed & contact arrangement	Cable type / length	Contact	Action force	Material of Rind
Standard type Momentary Action	TFS-101	10A 250VAC	TM1704	0.75mm ² , 3C/0.5 meter(米), 1 meter(米) - 3 meter(米)	1A1B	1.2kg	Plastic
	TFS-3	10A 250VAC	Micro-switch Momentary	0.75mm ² , 3C/0.5 meter(米), 1 meter(米) - 3 meter(米)	1A1B	1.2kg	Aluminum Cast
	TFS-3S	15A 250VAC	TM1704	0.75mm ² , 3C/1 meter(米), 1 meter(米) - 3 meter(米)	1A1B	2kg	
Standard type Alternate action	TFS-105	6A 250VAC	Imported alternative switch	0.75mm ² , 2C/1 meter(米), 1 meter(米) - 2 meter(米)	PUSH ON PUSH OFF	2kg	Plastic
	TFS-106	6A 250VAC	Imported Micro-switch	0.75mm ² , 3C/1 meter(米)	PUSH 1A PUSH 1B	1.5kg	
Mini foot switch Front end push	TFS-201	10A 250VAC	Micro-switch Momentary	0.5mm ² , 3C/1 meter(米) - 3 meter(米)	1A1B	0.7kg	Plastic
	TFS-01	10A 250VAC		0.5mm ² , 3C/1 meter(米) - 3 meter(米)	1A1B	0.7kg	
	TFS-1	10A 250VAC		0.5mm ² , 3C/1 meter(米) - 3 meter(米)	1A1B	0.9kg	Iron
Protective guard foot switch	TFS-302	15A 250VAC	TM1704	Accessory: Cable gland (No cable)	1A1B	3.2kg	Plastic + Aluminum Cast
	TFS-305	6A 250VAC	Imported alternative switch		PUSH ON PUSH OFF	3.1kg	
	TFS-306	6A 250VAC	Imported Micro-switch		PUSH 1A PUSH 1B	3.5kg	
	TFS-502	15A 250VAC	TM1704		1A1B	3.2kg	
	TFS-602	15A 250VAC	Button spring type		2*1A1B	2.8kg	
	TFS-702	15A 250VAC	TM1704		2*1A1B	3.2kg	
Large type	TFS-402	15A 250VAC	TM1704	1A1B	3.2kg		
	TFS-802	15A 250VAC	TM1704	2*1A1B	3.2kg		

NOTES: 1, Add "R" for waterproof, available in CFS3 & CFS4.

Appearance and Dimension

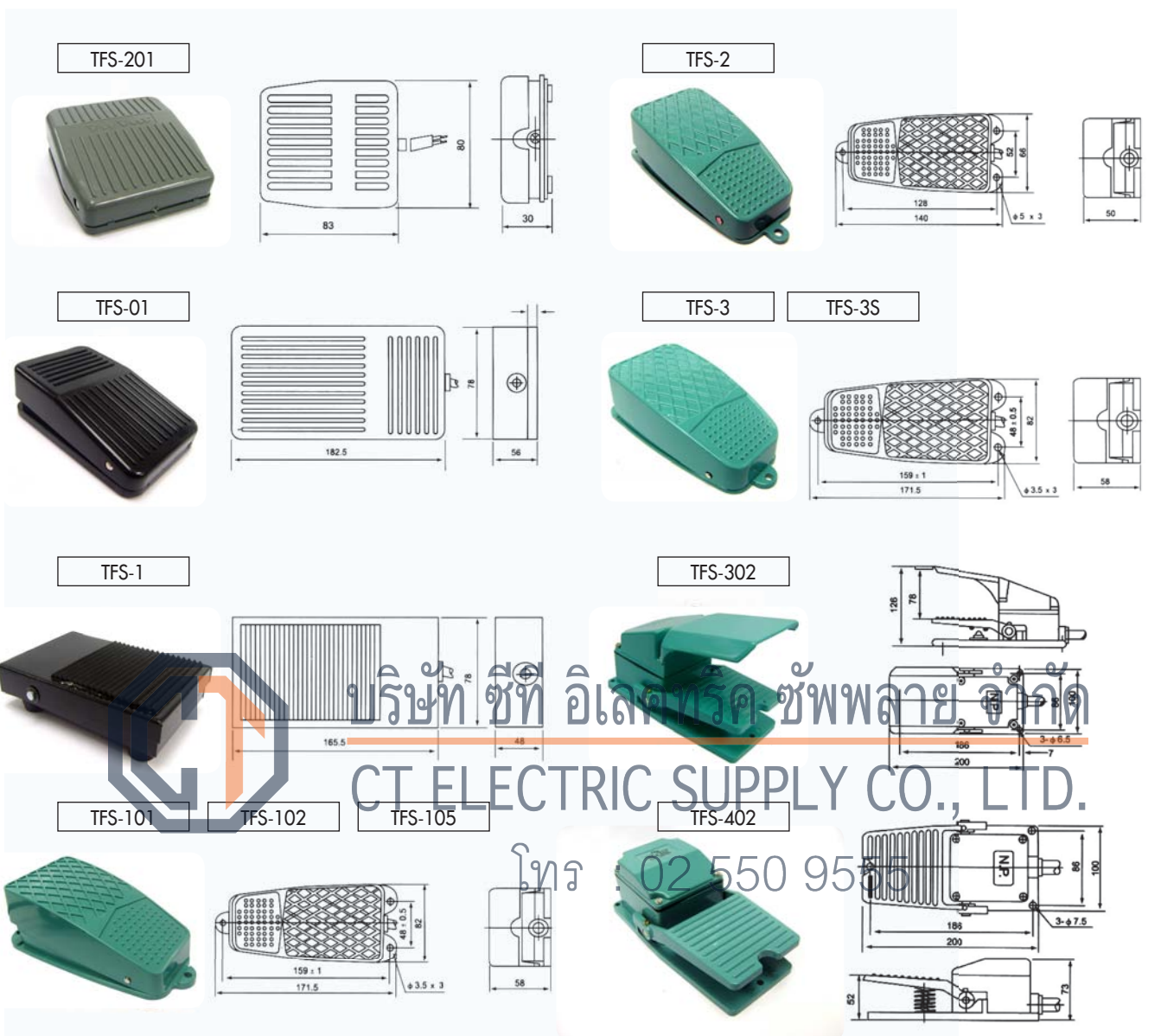

บริษัท ซีที อิเล็กทริค ซัพพลาย จำกัด
 CT ELECTRIC SUPPLY CO., LTD.

โทร 02 550 9585

Foot Switch

รุ่น (Model)	Rating Voltage	Rated Current	Contact Arrangement	ราคา (฿)
TFS-01	10A	250V	1A 1B	320.-
TFS-1	10A	250V	1A 1B	350.-
TFS-2	10A	250V	1A 1B	450.-
TFS-3	10A	250V	1A 1B	500.-
TFS-3S	15A	250V	1A 1B	550.-
TFS-101	10A	250V	1A 1B	450.-
TFS-102	15A	250V	1A 1B	800.-
TFS-105	6A	250V	PUSH ON PUSH OFF	670.-
TFS-201	10A	250V	1A 1B	280.-
TFS-302	15A	250V	1A 1B	1,150.-
TFS-402	15A	250V	1A 1B	1,100.-

Hoist Push Button Switch สวิตช์คอน สวิตช์รอกไฟฟ้ากันน้ำ



สวิตช์คอน สวิตช์รอกไฟฟ้ากันน้ำ

รุ่น (Model)	รายละเอียด	Rated	ราคา (฿)
COP-61	สวิตช์กดครบ 2 ปุ่ม ชนิดต่อตรง	250V 5A	700 .-
COP-62	สวิตช์กดครบ 4 ปุ่ม ชนิดต่อตรง	250V 15A	1,300 .-
COP-63	สวิตช์กดครบ 6 ปุ่ม ชนิดต่อตรง	250V 15A	2,000 .-
COB-61	สวิตช์กดครบ 2 ปุ่ม ผ่านแมกเนติก	250V 5A, 500V 2A	180 .-
COB-62	สวิตช์กดครบ 4 ปุ่ม ผ่านแมกเนติก	250V 5A, 500V 2A	280 .-
COB-63	สวิตช์กดครบ 6 ปุ่ม ผ่านแมกเนติก	250V 5A, 500V 2A	450 .-
COB-64	สวิตช์กดครบ 8 ปุ่ม ผ่านแมกเนติก	250V 5A	500 .-

สวิตช์โยกเดินหน้า-ถอยหลัง



โทร : 02 550 9555

Type No. (รุ่น)	Rated Current	Capacity (kw)	Details	ราคาตัวละ/บาท
QS5-15N	15A	4 kw	ALUMINIUM	200 .-
QS5-30N	30A	7.5 kw	ALUMINIUM	360 .-

Monolever Switch สวิตช์โยก 4 ทิศทาง



CMR-301

MOUNTING HOLE : \varnothing 30 mm (2 NO)
 No. OF CONTACT BLOCK : 1~4
 MOVEMENT WAY
 CMR-301-2 : SPING-RETURN
 CMR-301-1 : LOCKED



➔ ราคาตัวละ 850 .-



CMR-302

MOUNTING HOLE : \varnothing 30 mm (4 NO)
 No. OF CONTACT BLOCK : 1~4
 MOVEMENT WAY
 CMR-302-2 : SPING-RETURN
 CMR-302-1 : LOCKED



➔ ราคาตัวละ 950 .-

Fuse Switches

ฟิวส์สวิตช์ รุ่น RT-18, RT-38 (รุ่นมีไฟและไม่มีไฟ)

การประยุกต์งาน (Application) สวิตช์ฟิวส์ ใช้สำหรับป้องกันส่วนของวงจรภายในที่อยู่อาศัยและอุตสาหกรรม สามารถป้องกันกระแสเกิน กระแสลัดวงจร ตลอดจนการเสียหายต่ออันตรายต่างๆ ที่อาจเกิดขึ้นได้ ซึ่งสอดคล้องตามมาตรฐาน NFE 61910 ใช้ในตู้จ่ายไฟฟ้า ตั้งแต่ 3 ถึง 36 กิโลวัตต์ (KW) การใช้งานเหมาะสำหรับที่อยู่อาศัย และอื่นๆ เช่น บ้านขนาดเล็ก ธุรกิจการเกษตร ศูนย์การค้า โรงแรม ภัตตาคาร โรงงาน เป็นต้น

Characteristics	
In accordance with standard NFC 63210	
Operating voltage	: 230/400V (max. 440V)
Rated currents	: from 2 to 32A
Fuse links with or without striler pin	
domestics	: from 2 to 32A NFC 61201
industrials	: from 0.5 to 20A gI and aM NFC 63210
Connection	: cage terminals 10 mm
Protection degree	: IP20



รุ่น RT-18 1 POLE (รุ่นมีไฟ) ใช้สำหรับลูกฟิวส์ RT-10

Type No.	จำนวนโพล	ขนาดแอมป์	บรรจุกล่องละ	ราคาตัวละ/บาท
RT-18 (รุ่นไม่มีไฟ)	1 Pole	2A, 4A, 6A, 10A, 16A, 20A, 25A, 32A	12 ตัว	70 .-



รุ่น RT-18 2 POLE (รุ่นมีไฟ) ใช้สำหรับลูกฟิวส์ RT-10

Type No.	จำนวนโพล	ขนาดแอมป์	บรรจุกล่องละ	ราคาตัวละ/บาท
RT-18 (รุ่นไม่มีไฟ)	2 Pole	2A, 4A, 6A, 10A, 16A, 20A, 25A, 32A	6 ตัว	170 .-



รุ่น RT-18 3 POLE (รุ่นมีไฟ, รุ่นไม่มีไฟ) ใช้สำหรับลูกฟิวส์ RT-10

Type No.	จำนวนโพล	ขนาดแอมป์	บรรจุกล่องละ	ราคาตัวละ/บาท
RT-18 (รุ่นไม่มีไฟ)	3 Pole	2A, 4A, 6A, 10A, 16A, 20A, 25A, 32A	4 ตัว	200 .-
RT-18 (รุ่นไม่มีไฟ)	3 Pole	2A, 4A, 6A, 10A, 16A, 20A, 25A, 32A	4 ตัว	N/A

บริษัท ซีที อิเล็กทริก ซัพพลาย จำกัด
CT ELECTRIC SUPPLY CO., LTD.

โทร : 02 550 9555



ฐานฟิวส์สำหรับใส่ฟิวส์หลอดแก้ว และฟิวส์กระบอกรุ่น RT-14, RT-22

Type No.	จำนวนโพล	ขนาด	รุ่น (Model)	ราคาตัวละ/บาท
STS-10	1 Pole	10A, 6 x 32 mm	มีฝาครอบ (รุ่นไม่มีไฟ) ใช้สำหรับฟิวส์หลอดแก้ว	35 .-
STS-10/I	1 Pole	10A, 6 x 32 mm	มีฝาครอบ (รุ่นมีไฟ) ใช้สำหรับฟิวส์หลอดแก้ว	45 .-
STS-10	2 Pole	30A, 6 x 32 mm	มีฝาครอบ (รุ่นไม่มีไฟ) ใช้สำหรับฟิวส์หลอดแก้ว	65 .-
STS-32	1 Pole	32A, 14 x 51 mm	มีฝาครอบ (รุ่นไม่มีไฟ) ใช้สำหรับฟิวส์กระบอก รุ่น RT-14 X 51mm	150 .-

D-Fuse & Cylindrical Fuse



ฐานฟิวส์ E-16 รุ่นใส่ราง (E-16 Fuse Base-Din Rail Type)

Type No. (รุ่น)	Rated Current/voltage	USRC กล่องละ:	ราคา/฿
E-16	30A/600V	100	60 .-

ลูกฟิวส์ รุ่น E-16, E-27 และ ฟิวส์กระบอก รุ่น RT-10, RT-14, RT-22 กระบอกฟิวส์ดำหน้าตู้



E-16



E-27



ลูกฟิวส์ รุ่น E-16, E-27 ใช้กับฐานฟิวส์แบบทราลล์ รุ่น E-16, E-27

Type No.	ขนาดแอมป์	บรรจุกล่องละ:	ราคาตัวละ/บาท
E-16	2A, 4A, 6A 10A, 16A, 20A, 25A	100 ลูก (25 ลูก X 4 กล่อง)	10 .-
E-27	4A, 6A, 10A, 16A, 20, 25A	10	20 .-

บริษัท ซีที อิเล็กทริก ซัพพลาย จำกัด

ฟิวส์กระบอก รุ่น AF-10 ใช้กับฟิวส์ลิวเวอร์ รุ่น RT-38 ขนาด 10 X 38 mm.

Type No.	ขนาด/mm	ขนาดแอมป์	บรรจุกล่องละ:	ราคาตัวละ/บาท
AT-10	10x38	2A, 4A, 6A 10A, 16A, 20A, 25A, 32A	100 ลูก (100 ลูก X 10 กล่อง)	9 .-

ฟิวส์กระบอก รุ่น AF-14 ขนาด 14 X 51 mm., AF-22 ขนาด 22 X 58 mm.



Type No.	ขนาด (mm.)	ขนาดแอมป์	บรรจุกล่องละ:	ราคาตัวละ/บาท
AF-14	14 x 51	4A, 6A 10A, 16A, 20A, 25A, 32A, 45A, 50A, 63A	10 ลูก	24 .-
AF-22	22 x 58	4A, 8A 10A, 16A, 20A, 25A, 32A, 40A, 50A, 63A	10 ลูก	N/A



กระบอกฟิวส์ดำหน้าตู้ EFB107

Type No.	ขนาด (mm.)	ราคาตัวละ/บาท
EFB107 กระบอกฟิวส์ดำเล็ก สีดำ	5 x 20	15 .-
EFB107 กระบอกฟิวส์ดำใหญ่ สีดำ	6 x 30	15 .-

HRC FUSE Link & Fuse Base Component

ฐานฟิวส์และฟิวส์ใบมีดรุ่น NH

Standard : ● IEC 269-1,2,2-1 Rated Voltage : 500V Breaking ● CSN 354701-1,2,2-1 Capacity : 120KA ● DIN 43620 Rating Current : 16 To 630A



ฟิวส์ใบมีด รุ่น NH-00 (Size 00)

Type	ขนาดแอมป์	บรรจุกล่อง:	ราคาตัวละ/บาท
NH-00	16A, 20A, 25A 32A, 40A	5 PCS.	85 .-
	50A, 63A, 80A, 100A		85 .-
	125A, 160A		85 .-

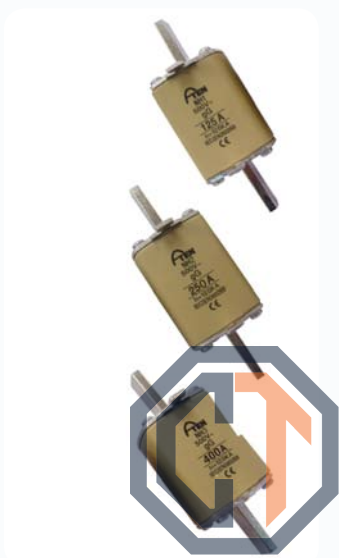

ฟิวส์ใบมีด รุ่น NH-1 (Size 1)

Type	ขนาดแอมป์	บรรจุกล่อง:	ราคาตัวละ/บาท
NH-1	50A, 63A, 80A 100A	3 PCS.	155 .-
	125A, 160A, 200A, 250A		155 .-

ฟิวส์ใบมีด รุ่น NH-2 (Size 2)

Type	ขนาดแอมป์	บรรจุกล่อง:	ราคาตัวละ/บาท
NH-2	200A, 250A, 315A, 400A	2 PCS.	210 .-

ฟิวส์ใบมีด รุ่น NH-3 (Size 3)

Type	ขนาดแอมป์	บรรจุกล่อง:	ราคาตัวละ/บาท
NH-3	400A, 500A, 630A	2 PCS.	420 .-

บริษัท ซีที อิล렉ทริค ซัพพลาย จำกัด

CT ELECTRIC SUPPLY CO., LTD.

โทร : 02 550 9555



ฐานฟิวส์ใบมีด รุ่น HRC-FUSE#00 (Size-00)

Type No	จำนวนโพล	ขนาดแอมป์	ราคาตัวละ/บาท
HRC-FUSE BASE#00/1POLE	1 POLE	160A	100 .-
HRC-FUSE BASE#00/3POLE	3 POLE	160A	300 .-



ฐานฟิวส์ใบมีด รุ่น HRC-FUSE BASE#1 (Size-1)

Type No	จำนวนโพล	ขนาดแอมป์	ราคาตัวละ/บาท
HRC-FUSE BASE#1/1POLE	1 POLE	250A	330 .-



ฐานฟิวส์ใบมีด รุ่น HRC-FUSE BASE#2 (Size-2)

Type No	จำนวนโพล	ขนาดแอมป์	ราคาตัวละ/บาท
HRC-FUSE BASE#2/1POLE	1 POLE	400A	500 .-



ค้ำดึงฟิวส์ (Fuse Handle)

Catalog No.	Description	ราคา (฿)
F000-4	ใช้กับฟิวส์ใบมีด #00, #1, #2, #3	200 .-

Made In Japan

สินค้าคุณภาพจาก ญี่ปุ่น

มั่นใจทุกครั้งที่ใช้



บริษัท ซีที อีเลคทริค ซัพพลาย จำกัด
CT ELECTRIC SUPPLY CO., LTD.

โทร : 02-550 9500



ME2592W 



ME2538 



ME2542 



ME2543 



MH2571 



MH2572 



MH2574 



MH2575 



MH2576 



MH2577 



MH2578 



MH2579 



บริษัท ชท อิเล็กทริค ซัพพลาย จำกัด
 CTELECTRIC SUPPLY CO., LTD.
 โทร : 02 530 9555

Plugs, Sockets และ Connector ผลิตจากประเทศญี่ปุ่น แข็งแรง ทนทาน เหมาะสำหรับใช้งานอุตสาหกรรม และอื่นๆ

รุ่น (Model)	Pole	Rated Voltage	Rated Current	ราคา (฿)
ME2592W	2P + E	125 V	15 A	165 .-
ME2538	2P + E	125 V	15 A	250 .-
ME2542	2P + E	125 V	15 A	430 .-
ME2543	2P + E	125 V	15 A	480 .-
MH2571	2P	125 V	15 A	195 .-
MH2572	2P + E	125 V	15 A	215 .-
MH2574	2P	250 V	20 A	240 .-
MH2575	3P	250 V	20 A	360 .-
MH2576	3P + E	250 V	20 A	430 .-
MH2577	2P + E	250 V	30 A	1,425 .-
MH2578	2P + E	250 V	30 A	1,320 .-
MH2579	3P + E	250 V	30 A	1,410 .-

 : ชนิดกันน้ำ



บริษัท ชีที อิเล็กทริค ซัพพลาย จำกัด
 C.T. ELECTRIC SUPPLY CO., LTD.
 โทร : 02-550-9555

Plugs, Sockets และ Connector ผลิตจากประเทศญี่ปุ่น แข็งแรง ทนทาน เหมาะสำหรับใช้งานอุตสาหกรรม และอื่นๆ

รุ่น (Model)	Pole	Rated Voltage	Rated Current	ราคา (฿)
MH2580	3P + E	480 V	30 A	1,850 .-
MH2582	2P	250 V	20 A	590 .-
MH2583	3P	250 V	20 A	750 .-
MH2584	3P + E	250 V	20 A	850 .-
MH2587	3P + E	250 V	30 A	990 .-
MH2589	2P + E	125 V	15 A	550 .-
MH2594	3P + E	250 V	30 A	1,700 .-
MH2598	3P + E	250 V	20 A	860 .-
MH7038	2P + E	250 V	20 A	940 .-
MP2518	2P	125 V	15 A	205 .-
MP2536	3P + E	250 V	15 A	550 .-
MP2506	2P	125 V	15 A	118 .-

 : ใช้น้ำได้



Plugs, Sockets และ Connector ผลิตจากประเทศญี่ปุ่น แข็งแรง ทนทาน เหมาะสำหรับการใช้งานอุตสาหกรรม และอื่นๆ

โทร : 02-550-9555

รุ่น (Model)	Pole	Rated Voltage	Rated Current	ราคา (฿)
MC2616	2P	125 V	15 A	950 .-
MC2614	3P	250 V	15 A	770 .-
MC2620	3P + E	250 V	15 A	800 .-
MC2623	3P + E	250 V	30 A	1,900 .-
ME2624	2P+ E	125 V	15 A	530 .-
MH2631	2P+ E	125 V	15 A	670 .-
MH2633	3P	250 V	20 A	1,020 .-
MH2634	3P + E	250 V	20 A	1,170 .-
MH2638	3P + E	250 V	30 A	2,080 .-
MH2648	3P + E	250 V	20 A	1,200 .-
MH2649	3P	250 V	20 A	1,450 .-
ME2726W	2P + E	125 V	15 A	255 .-
ME2746W	2P + E	125 V	15 A	255 .-
ME2816	2P + E	125 V	15 A	245 .-
MH2875	3P	250 V	20 A	365 .-

 : เข็ดกันน้ำ



Plugs, Sockets และ Connector ผลิตจากประเทศญี่ปุ่น ใช้งานได้ยาวนาน เหมาะสำหรับการใช้งานอุตสาหกรรม และอื่นๆ โทร : 02-550-9555

รุ่น (Model)	Pole	Rated Voltage	Rated Current	ราคา (฿)
MH2875	3P	250 V	20 A	365 .-
MH2876	3P + E	250 V	20 A	610 .-
MH2877	2P + E	250 V	20 A	470 .-
MH2878	2P + E	250 V	30 A	930 .-
MH2879	3P + E	250 V	30 A	1,220 .-
MH2882	2P	125 V	15 A	290 .-
MH2886	3P	250 V	20 A	430 .-
MH2887	3P + E	250 V	20 A	660 .-
MH2889	2P + E	250 V	30 A	1,200 .-
MH2890	3P + E	250 V	30 A	1,410 .-
MK5645W1	Plugs + Connector	125 V	15 A	195 .-
MR3204	ปลั๊กสวิตช์กระตุก	300 V	10 A	260 .-
MU2808	3P	250 V	15 A	235 .-
MU2815	3P + E	250 V	30 A	1,350 .-

 : ชนิดกันน้ำ

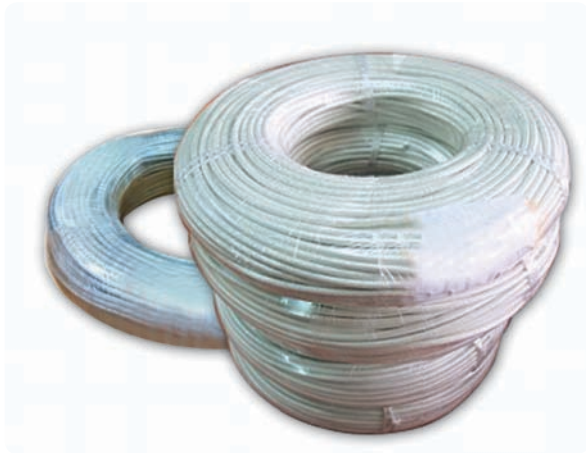

SILICON RUBBER INSULATED
WIRE OUTER SIEGE WITH GLASS
FIBER BRAIDS MADE IN JAPAN

สายไฟฟ้าทนความร้อน (ใยแก้วหุ้มยาง) ยาวม้วนละ: 100 เมตร

รุ่น (Model)	พื้นที่หน้าตัด Copper Diameter (mm ²)	ราคา/ม้วน Price/Roll (฿)
REH-SG	0.50	1,350 .-
REH-SG	0.75	1,650 .-
REH-SG	1.00	1,850 .-
REH-SG	1.50	2,400 .-
REH-SG	2.00	2,850 .-
REH-SG	2.50	3,800 .-
REH-SG	3.50	4,800 .-
REH-SG	4.00	5,800 .-
REH-SG	5.50	7,600 .-
REH-SG	6.00	8,000 .-
REH-SG	8.00	11,000 .-
REH-SG	10.00	15,000 .-
REH-SG	16.00	23,000 .-
REH-SG	25.00	40,000 .-
REH-SG	35.00	50,000 .-
REH-SG	50.00	70,000 .-
REH-SG	70.00	103,000 .-
REH-SG	95.00	142,000 .-
REH-SG	100.00	153,000 .-
REH-SG	120.00	200,000 .-

น้ำยาล้างคอนแทก Expert



น้ำยาล้างคอนแทก Expert ละเอียดเร็ว สะอาด ไม่ทิ้งคราบใดๆ กำจัดฟุ้ง สิ่งสกปรก คราบไขมัน น้ำมันเครื่อง, เศษยางเหนียวต่างๆ โดยไม่มี ปฏิกิริยากับวัตถุใดๆ ทั้งสิ้น

Expert สเปรย์ / ล้างคอนแทก

ขนาดบรรจุ 450 กรัม

ราคา 250 บาท /กระป๋อง

KOKUSAI A.C. SOLINOID AND TERMINAL BLOCK WITH PLASTIC COVER



A.C. SOLINOID BRAKE 220V

TYPE NO.	PUSH OR PULL	RATED STROKE (mm)	RATED PULL (kg)	RATED SERVICE	RATED CYCLE	L x W x H (mm)	PLUNGER WEIGHT	TOTAL WEIGHT	PRICE
SA-992	PUSH PULL COMBINED	10	0.5	CONTINUOUS	50/60HZ	84x33x38	0.062	0.20	500 .-
SA-1192		10	0.8	CONTINUOUS	50/60HZ	84x42x38	0.095	0.30	570 .-
SA-21		10	1.0	-	50/60HZ	85x46x51	-	-	660 .-
SA-2502		15	1.5	CONTINUOUS	50/60HZ	93x53x50	0.138	0.45	730 .-
SA-2602		15	2.0	CONTINUOUS	50/60HZ	93x57x50	0.153	0.50	750 .-
SA-3502		20	3.0	CONTINUOUS	50/60HZ	130x70x63	0.302	1.15	1,160 .-
SA-3602		20	4.0	CONTINUOUS	50/60HZ	130x75x63	0.348	1.30	1,400 .-
SA-3702		20	5.0	CONTINUOUS	50/60HZ	145x80x78	0.649	1.75	1,620 .-
SA-4502		30	6.0	CONTINUOUS	50/60HZ	170x100x86	0.777	2.70	2,770 .-
SA-52		40	10.0	CONTINUOUS	50/60HZ	230x113x102	1.832	4.80	4,620 .-



บริษัท ซีที อิเล็กทริก ซัพพลาย จำกัด

ดอกเจาะรูกลม (สำหรับเจาะสแตนเลส)

CT ELECTRIC SUPPLY CO., LTD.

โทร : 02-550-9555

ขนาดโฮลซอ (METRIC SIZES)		ขนาดคอนดัก (SIZE FOR CONDUIT)		
รุ่น	ขนาด (มิล)	ขนาด (นิ้ว)	ขนาด (นิ้ว) ก่อ	ราคา/บาท
TCT-16	16	5/8	-	870.-
TCT-19	19	3/4	-	870.-
TCT-20	20	-	-	870.-
TCT-22	22	7/8	1/2	950.-
TCT-25	25	1	-	950.-
TCT-28	28	-	3/4	1,120.-
TCT-30	30	1-1/8	-	1,120.-
TCT-32	32	1-1/4	-	1,270.-
TCT-33	33	-	-	1,270.-
TCT-34	34	1-3/8	1	1,270.-
TCT-35	35	1-3/8	1	1,270.-
TCT-38	38	1-1/2	-	1,480.-
TCT-41	41	1-5/8	-	1,740.-

ขนาดโฮลซอ (METRIC SIZES)		ขนาดคอนดัก (SIZE FOR CONDUIT)		
รุ่น	ขนาด (มิล)	ขนาด (นิ้ว)	ขนาด (นิ้ว) ก่อ	ราคา/บาท
TCT-43	43	1-3/4	1-1/4	1,840.-
TCT-44	44	-	-	1,840.-
TCT-48	48	-	1-1/2	2,000.-
TCT-49	49	-	1-1/2	2,000.-
TCT-50	50	-	1-1/2	2,000.-
TCT-51	51	2	-	2,220.-
TCT-60	60	-	2	3,150.-
TCT-61	61	-	-	3,150.-
TCT-64	64	2-1/2	-	3,150.-
TCT-70	70	-	-	3,500.-
TCT-73	73	-	2-1/2	3,600.-
TCT-76	76	3	-	4,050.-
TCT-89	89	3-1/2	3	4,750.-



บริษัท ซีที อิเล็กทริก ซัพพลาย จำกัด

ดอกเจาะรูกลม (สำหรับเจาะเหล็ก)

CT ELECTRIC SUPPLY CO., LTD.

โทร : 02-550 9555

ขนาดโฮลซอ (METRIC SIZES)		ขนาดคอนดุก (SIZE FOR CONDUIT)		
รุ่น	ขนาด (มิล)	ขนาด (นิ้ว)	ขนาด (นิ้ว) ท่อ	ราคา/บาท
HSS-13	13	1/2	-	350.-
HSS-16	16	5/8	-	380.-
HSS-19	19	3/4	-	380.-
HSS-20	20	-	-	450.-
HSS-22	22	7/8	1/2	450.-
HSS-25	25	1	-	480.-
HSS-28	28	-	3/4	550.-
HSS-30	30	1-1/8	-	550.-
HSS-31	31	-	-	550.-
HSS-32	32	1-1/4	-	550.-
HSS-33	33	-	-	700.-
HSS-34	34	1-3/8	1	700.-
HSS-35	35	1-3/8	1	700.-
HSS-38	38	1-1/2	-	900.-
HSS-41	41	1-5/8	-	900.-

ขนาดโฮลซอ (METRIC SIZES)		ขนาดคอนดุก (SIZE FOR CONDUIT)		
รุ่น	ขนาด (มิล)	ขนาด (นิ้ว)	ขนาด (นิ้ว) ท่อ	ราคา/บาท
HSS-43	43	1-3/4	1-1/4	1,050.-
HSS-44	44	-	-	1,050.-
HSS-45	45	-	-	1,050.-
HSS-48	48	-	1-1/2	1,240.-
HSS-49	49	-	1-1/2	1,240.-
HSS-50	50	-	1-1/2	1,240.-
HSS-51	51	2	-	1,240.-
HSS-54	54	-	-	1,240.-
HSS-60	60	-	2	1,400.-
HSS-61	61	-	-	1,400.-
HSS-64	64	2-1/2	-	1,400.-
HSS-70	70	-	-	2,100.-
HSS-73	73	-	2-1/2	2,450.-
HSS-76	76	3	-	2,450.-
HSS-89	89	3-1/2	3	3,000.-



ปลั๊กตัวพู้, ปลั๊กตัวเมีย, สวิตช์ และ ฟาสวิตช์ แข็งแรง ทนทาน เหมาะสำหรับใช้งานอุตสาหกรรม และอื่นๆ

รุ่น (Model)	Pole	Rated Voltage	Rated Current	ราคา (฿)
COOP-1709	2P3W	125 V	15 A	135 .-
COOP-2132B	ฝาปลั๊กคู่ (สีน้ำตาล)			21 .-
COOP-2132V	ฝาปลั๊กคู่ (สีงา)			21 .-
COOP-2134B	ฝาสวิทช์เดี่ยว (สีน้ำตาล)			19 .-
COOP-2134V	ฝาสวิทช์เดี่ยว (สีงา)			19 .-
COOP-270B (TR270B)	2P3W	125 V	15 A	42 .-
COOP-270V (TR270V)	2P3W	125 V	15 A	42 .-
COOP-2866	2P3W	250 V	15 A	130 .-
COOP-2867	2P3W	125 V	15 A	116 .-
COOP-2887	2P3W	125 V	15 A	235 .-
COOP-32	3P3W	125/250 V	50 A	210 .-
COOP-40	3P3W	125/250 V	50 A	355 .-
COOP-4866	2P3W	250 V	15 A	130 .-
COOP-4867	2P3W	125 V	15 A	118 .-
COOP-7410 (สักรับ)	2P + E	208 V	20 A	580 .-

COOP-805B (ปลั๊กเดี่ยว)



COOP-805B (ปลั๊กเดี่ยว)



COOP-816V (ปลั๊กเดี่ยว)



COOP-817B (ปลั๊กเดี่ยว)



COOP-817V (ปลั๊กเดี่ยว)



COOP-826B (ปลั๊กคู่)



COOP-826V (ปลั๊กคู่)



COOP-827B (ปลั๊กตัวเมีย)



COOP-827V (ปลั๊กตัวเมีย)



COOP-CS115B (สวิตช์)



COOP-CS115V (สวิตช์)



COOP-CS315 (สวิตช์ 3 ทง)



COOP-S1961 (พาด็ยกันน้ำ)



COOP-S1962 (พาด็ยกันน้ำ)



บริษัท ซีที อิเล็กทริก ซัพพลาย จำกัด
CT ELECTRIC SUPPLY CO., LTD.

โทร : 02 550 9555

ปลั๊กตัวผู้, ปลั๊กตัวเมีย, สวิตช์ และ ฟาสวิตช์ แข็งแรง ทนทาน เหมาะสำหรับใช้งานอุตสาหกรรม และอื่นๆ

รุ่น (Model)	Pole	Rated Voltage	Rated Current	ราคา (฿)
COOP-805B	3P3W	125/250 V	15 A	220 .-
COOP-816B	2P3W	250 V	15 A	120 .-
COOP-816V	2P3W	250 V	15 A	120 .-
COOP-817B	2P3W	125 V	15 A	125 .-
COOP-817V	2P3W	125 V	15 A	125 .-
COOP-826B	2P3W	250 V	15 A	200 .-
COOP-826V	2P3W	250 V	15 A	200 .-
COOP-827B	2P3W	125 V	15 A	145 .-
COOP-827V	2P3W	125 V	15 A	145 .-
COOP-CS115B	สวิตช์	120/277 V	15 A	130 .-
COOP-CS115V	สวิตช์	120/277 V	15 A	130 .-
COOP-CS315	สวิตช์ 3 ทง	120/277 V	15 A	230 .-
COOP-S1961	พาด็ยกันน้ำ (พลาสติก)			140 .-
COOP-S1962	พาด็ยกันน้ำ (พลาสติก)			145 .-