

HT plug sockets and couplers IP44 splash proof

HT013	16A	2P+E	Price: 100฿(บาท)	Earth contact position	6h
HT023	32A	2P+E	135฿(บาท)	Pole	3
				Voltage	220-250V
				Dimension(mm)	16A 32A
				a	122 139
				b	59 75
				c	6 8
				d	50 64
				Cable nominal cross-section area(mm ²)	1-2.5 2.5-6

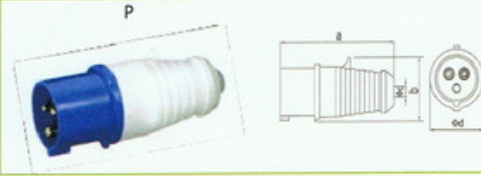

HT014	16A	3P+E	Price: 120฿(บาท)	Earth contact position	6h
HT024	32A	3P+E	160฿(บาท)	Pole	4
				Voltage	380-415V
				Dimension(mm)	16A 32A
				a	122 139
				b	65 75
				c	6 8
				d	54 64
				Cable nominal cross-section area(mm ²)	1-2.5 2.5-6

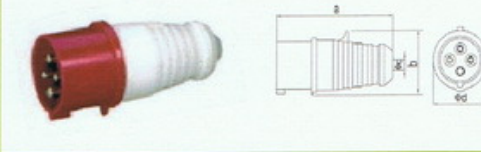

HT015	16A	3P+N+E	Price: 140฿(บาท)	Earth contact position	6h
HT025	32A	3P+N+E	180฿(บาท)	Pole	5
				Voltage	220 - 380V 240 - 415V
				Dimension(mm)	16A 32A
				a	122 139
				b	65 75
				c	6 8
				d	54 64
				Cable nominal cross-section area(mm ²)	1-2.5 2.5-6



HT513	16A	2P+E	Price: 630฿(บาท)	Earth contact position	6h
HT523	32A	2P+E	750฿(บาท)	Pole	3
				Voltage	220-250V
				Dimension(mm)	16A 32A
				a	121 131
				b	76 83
				Cable nominal cross-section area(mm ²)	1.5-4 2.5-6

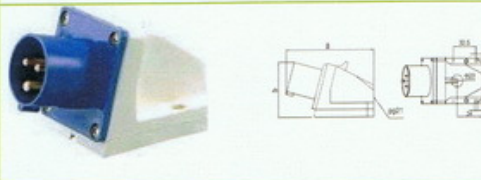

ราคาข้างต้นสามารถเปลี่ยนแปลงได้โดยไม่ต้องแจ้งให้ทราบล่วงหน้า



บริษัท ซีที อิเล็กทริค ซัพพลาย จำกัด
CT ELECTRIC SUPPLY CO., LTD.

โทร: 02-550-9555

HT plug sockets and couplers IP44 splash proof

HT514	16A	3P+E	Price: 670฿(บาท)	Earth contact position	6h
HT524	32A	3P+E	780฿(บาท)	Pole	4
				Voltage	380-415V
				Dimension(mm)	16A 32A
				a	124 131
				b	76 83
				Cable nominal cross-section area(mm ²)	1.5-4 2.5-6

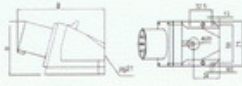

HT113	16A	2P+E	Price: 175฿(บาท)	Earth contact position	6h
HT123	32A	2P+E	240฿(บาท)	Pole	3
				Voltage	220-250V
				Dimension(mm)	16A 32A
				a	131 149
				b	88 100
				Cable nominal cross-section area(mm ²)	1.5-4 2.5-10

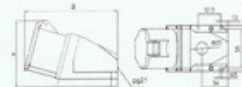

HT114	16A	3P+E	Price: 185฿(บาท)	Earth contact position	6h
HT124	32A	3P+E	270฿(บาท)	Pole	4
				Voltage	380-415V
				Dimension(mm)	16A 32A
				a	132 149
				b	91 100
				Cable nominal cross-section area(mm ²)	1.5-4 2.5-10



HT115	16A	3P+N+E	Price: 205฿(บาท)	Earth contact position	6h
HT125	32A	3P+N+E	290฿(บาท)	Pole	5
				Voltage	220 - 380V 240 - 415V
				Dimension(mm)	16A 32A
				a	132 151
				b	98 101
				Cable nominal cross-section area(mm ²)	1.5-4 2.5-10

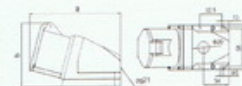

บริษัท ซีที อิเล็กทริก ซัพพลาย จำกัด
CT ELECTRIC SUPPLY CO., LTD.

โทร 02-550 9555

ราคาข้างต้นสามารถเปลี่ยนแปลงได้โดยไม่ต้องแจ้งให้ทราบล่วงหน้า

HT plug sockets and couplers IP44 splash proof

HT213	16A	2P+E	Price: 140฿(บาท)	Earth contact position	6h
HT223	32A	2P+E	180฿(บาท)	Pole	3
				Voltage	220-250V
				Dimension(mm)	16A 32A
				a	131 150
				b	70 92
				c	6 8
				Cable nominal cross-section area(mm ²)	1-2.5 2.5-6

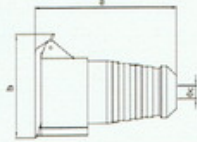

HT214	16A	3P+E	Price: 145฿(บาท)	Earth contact position	6h
HT224	32A	3P+E	210฿(บาท)	pole	4
				Voltage	380-415V
				Dimension(mm)	16A 32A
				a	131 150
				b	78 92
				c	6 8
				Cable nominal cross-section area(mm ²)	1-2.5 2.5-6

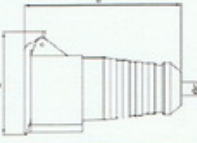

HT215	16A	3P+N+E	Price: 170฿(บาท)	Earth contact position	6h
HT225	32A	3P+N+E	245฿(บาท)	Pole	5
				Voltage	220 – 380V 240 – 415V
				Dimension(mm)	16A 32A
				a	140 154
				b	90 102
				c	6 8
				Cable nominal cross-section area(mm ²)	1-2.5 2.5-6

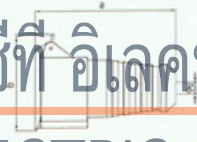

HT313	16A	2P+E	Price: 125฿(บาท)	Earth contact position	6h
HT323	32A	2P+E	200฿(บาท)	Pole	3(2P+E)
				Voltage	220-250V
				Dimension(mm)	16A 32A
				a	62 80
				b	68 96
				c	47 60
				d	48 70
				e	36 42
				f	37 43
				g	55 75
				Cable nominal cross-section area(mm ²)	1.5-4 2.5-10

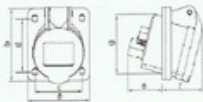

บริษัท ซีที อิเล็กทริก ซัพพลาย จำกัด
 CT ELECTRIC SUPPLY CO., LTD.
 โทร : 02 550 9555

ราคาข้างต้นสามารถเปลี่ยนแปลงได้โดยไม่ต้องแจ้งให้ทราบล่วงหน้า

HT plug sockets and couplers IP44 splash proof

HT314	16A	3P+E	Price: 150฿(บาท)	Earth contact position	6h
HT324	32A	3P+E	210฿(บาท)	Pole	4
				Voltage	380-415V
				Dimension(mm)	16A 32A
				a	76 80
				b	86 96
				c	60 60
				d	61 70
				e	47 42
				f	37 43
				g	64 75
				Cable nominal cross-section area(mm ²)	1.5-4 2.5-10

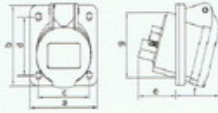

HT315	16A	3P+N+E	Price: 170฿(บาท)	Earth contact position	6h
HT325	32A	3P+N+E	230฿(บาท)	Pole	4
				Voltage	220 – 380V 240 – 415V
				Dimension(mm)	16A 32A
				a	76 81
				b	86 96
				c	60 60
				d	61 70
				e	47 42
				f	37 47
				g	72 81
				Cable nominal cross-section area(mm ²)	1.5-4 2.5-10

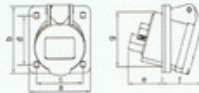

บริษัท ซีที อิเล็กทริค ซัพพลาย จำกัด
CT ELECTRIC SUPPLY CO., LTD.

HT plug sockets and couplers IP67 water proof

HT033	63A	2P+E	Price: 540฿(บาท)	Earth contact position	6h
				Pole	3
				Voltage	220-240V
				Dimension(mm)	63A
				a	230
				b	109
				c	36
				Cable nominal cross-section area(mm ²)	-

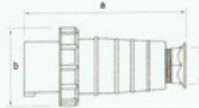



ราคาข้างต้นสามารถเปลี่ยนแปลงได้โดยไม่ต้องแจ้งให้ทราบล่วงหน้า

โทร: 02-550-9555

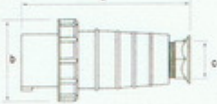
HT plug sockets and couplers IP67 water proof

HT034	63A	3P+E	Price: 620฿(บาท)	Earth contact position	6h
 				Pole	4
				Voltage	220-240V
				Dimension(mm)	63A
				a	230
				b	109
				c	36
				Cable nominal cross-section area(mm ²)	-

HT133	63A	2P+E	Price: 870฿(บาท)	Earth contact position	6h
 				Pole	3
				Voltage	220-240V
				Dimension(mm)	63A
				a	125
				b	109
				c	158
				d	191
				e	270
				Cable nominal cross-section area(mm ²)	-

HT134	63A	3P+E	Price 920฿(บาท)	Earth contact position	6h
 				Pole	4
				Voltage	380-415V
				Dimension(mm)	63A
				a	125
				b	109
				c	158
				d	191
				e	270
				Cable nominal cross-section area(mm ²)	-

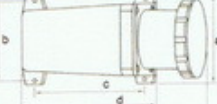

HT135	63A	3P+N+E	Price:1020฿(บาท)	Earth contact position	6h
 				Pole	5
				Voltage	220 - 380V
					240 - 415V
				Dimension(mm)	63A
				a	125
				b	109
				c	158
				d	191
				e	270
				Cable nominal cross-section area(mm ²)	-



บริษัท ซีที อิเล็คทริค ซัพพลาย จำกัด
CT ELECTRIC SUPPLY CO., LTD.

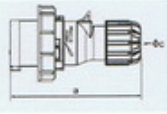

โทร : 02 550 9555

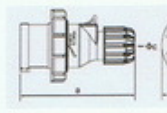

ราคาข้างต้นสามารถเปลี่ยนแปลงได้โดยไม่ต้องแจ้งให้ทราบล่วงหน้า

HTN plug sockets IP67 Watertight

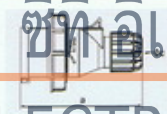
HTN0131	16A	2P+E	Price: 145฿(บาท)	Earth contact position	6h
				Pole	3
				Voltage	220-250V
				Dimension(mm)	16A
				a	120
				b	71
				c	12
				Cable nominal cross-section area(mm ²)	1-2.5

HTN0141	16A	3P+E	Price: 170฿(บาท)	Earth contact position	6h
				Pole	4
				Voltage	380-415V
				Dimension(mm)	16A
				a	125
				b	79
				c	12
				Cable nominal cross-section area(mm ²)	1-2.5

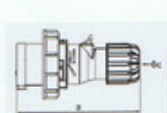
HTN0151	16A	3P+N+E	Price: 220฿(บาท)	Earth contact position	6h
				Pole	5
				Voltage	220 – 380V 240 – 415V
				Dimension(mm)	16A
				a	133
				b	87
				c	12
				Cable nominal cross-section area(mm ²)	1-2.5

HTN0231	32A	2P+E	Price: 240฿(บาท)	Earth contact position	6h
				Pole	3
				Voltage	220-250V
				Dimension(mm)	32A
				a	150
				b	93
				c	17
				Cable nominal cross-section area(mm ²)	2.5-6

ราคาข้างต้นสามารถเปลี่ยนแปลงได้โดยไม่ต้องแจ้งให้ทราบล่วงหน้า

บริษัท ซีที อิเล็กทริค ซัพพลาย จำกัด
CT ELECTRIC SUPPLY CO., LTD.

โทร : 02-650 9555

HTN plug sockets IP67 Watertight

HTN0241	32A	3P+E	Price: 270฿(บาท)	Earth contact position	6h
				pole	4
				Voltage	380-415V
				Dimension(mm)	32A
				a	150
				b	93
				c	17
				Cable nominal cross-section area(mm ²)	2.5-6

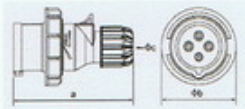

HTN0251	32A	3P+N+E	Price: 320฿(บาท)	Earth contact position	6h
				Pole	5(3P+N+E)
				Voltage	220 – 380V 240 – 415V
				Dimension(mm)	32A
				a	155
				b	99.5
				c	17
				Cable nominal cross-section area(mm ²)	2.5-6

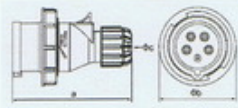

HTN0331	63A	2P+E	Price: 800฿(บาท)	Earth contact position	6h
HTN0341	63A	3P+E	960฿(บาท)	Pole	3/4/5
HTN0351	63A	3P+N+E	1000฿(บาท)		
				Dimension(mm)	63A
				a	250
				b	112.5
				c	30
				Cable nominal cross-section area(mm ²)	6-16



HTN0441	125A	3P+E	Price: 3080฿(บาท)	Earth contact position	6h
HTN0451	125A	3P+N+E	3150฿(บาท)	Pole	4/5
				Dimension(mm)	125A
				a	295
				b	126
				c	44.5
				Cable nominal cross-section area(mm ²)	16-50

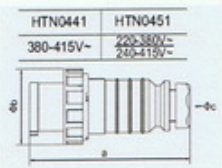



บริษัท ซีที อิเล็กทริก ซัพพลาย จำกัด
CT ELECTRIC SUPPLY CO., LTD.

โทร : 02 550 9555

ราคาข้างต้นสามารถเปลี่ยนแปลงได้โดยไม่ต้องแจ้งให้ทราบล่วงหน้า

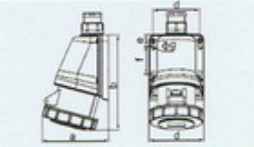
HTN wall mounted sockets IP67 Watertight

HTN1131	16A	2P+E	Price: 280฿(บาท)	Earth contact position	6h
				Pole	3
				Voltage	220-250V
				Dimension(mm)	16A
 				a	101
				b	150
				c	93.5
				d	80
				e	20
				f	46
				g	5.5
				Cable nominal cross-section area(mm ²)	1.5-4

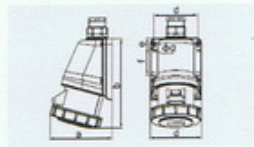
HTN1141	16A	3P+E	Price: 300฿(บาท)	Earth contact position	6h
				Pole	4
				Voltage	380-415V
				Dimension(mm)	16A
 				a	104
				b	150
				c	93.5
				d	80
				e	20
				f	46
				g	5.5
				Cable nominal cross-section area(mm ²)	1.5-4

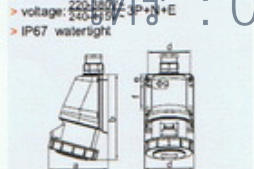
HTN1151	16A	3P+N+E	Price: 370฿(บาท)	Earth contact position	6h
				Pole	5
				Voltage	220 - 380V 240 - 415V
				Dimension(mm)	16A
  <ul style="list-style-type: none"> > current: 16A > voltage: 220-380V / 240-415V / 3P+N+E > IP67 watertight 				a	107
				b	151
				c	93.5
				d	80
				e	20
				f	46
				g	5.5
				Cable nominal cross-section area(mm ²)	1.5-4

บริษัท ซีที อิเล็กทริค ซัพพลาย จำกัด
CT ELECTRIC SUPPLY CO., LTD.

โทร : 02 550 9555

ราคาข้างต้นสามารถเปลี่ยนแปลงได้โดยไม่ต้องแจ้งให้ทราบล่วงหน้า

HTN wall mounted sockets IP67 Watertight

HTN1231	32A	2P+E	Price: 360฿(บาท)	Earth contact position	6h
				pole	3
				Voltage	220-250V
				Dimension(mm)	32A
				a	114
				b	162
				c	93.5
				d	80
				e	20
				f	46
				g	5.5
				Cable nominal cross-section area(mm ²)	2.5-10

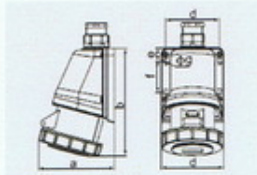

HTN1241	32A	3P+E	Price: 410฿(บาท)	Earth contact position	6h
				Pole	4
				Voltage	380-415V
				Dimension(mm)	32A
				a	114
				b	162
				c	93.5
				d	80
				e	20
				f	46
				g	5.5
				Cable nominal cross-section area(mm ²)	2.5-10

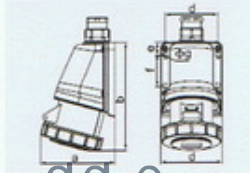

HTN1251	32A	3P+N+E	Price: 470฿(บาท)	Earth contact position	6h
				Pole	5(3P+N+E)
				Voltage	220-380V 240-415V
				Dimension(mm)	32A
				a	116
				b	163
				c	93.5
				d	80
				e	20
				f	46
				g	5.5
				Cable nominal cross-section area(mm ²)	2.5-10

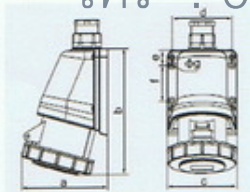

บริษัท ซีที อิเล็กทริค ซัพพลาย จำกัด

CT ELECTRIC SUPPLY CO., LTD.

โทร : 02-550-9555

ราคาข้างต้นสามารถเปลี่ยนแปลงได้โดยไม่ต้องแจ้งให้ทราบล่วงหน้า

HTN wall mounted sockets and industrial connector IP67 Watertight

HTN1331	63A	2P+E	Price: 1050฿(บาท)	Earth contact position	6h	
HTN1341	63A	3P+E	1350฿(บาท)	pole		
HTN1351	63A	3P+N+E	1500฿(บาท)		3/4/5	
Dimension(mm)					63A	
					a	171
					b	170
					c	230
					d	118
					e	158
					f	106
Cable nominal cross-section area(mm ²)					6-25	

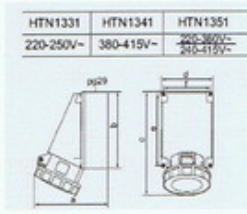

HTN1441	125A	3P+E	Price: 4500฿(บาท)	Earth contact position	6h	
HTN1451	125A	3P+N+E	4600฿(บาท)	Pole	4/5	
Dimension(mm)					125A	
					a	165
					b	230
					c	330
					d	160
					e	240
					f	160
Cable nominal cross-section area(mm ²)					25-70	

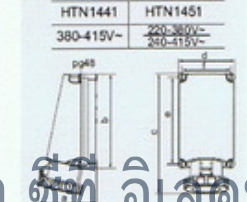

บริษัท ซีที อิเล็กทริก ซัพพลาย จำกัด
CT-ELECTRIC SUPPLY CO., LTD.

HTN2131	16A	2P+E	Price: 240฿(บาท)	Earth contact position	6h	
				Pole	3	
				Voltage	220-250V	
Dimension(mm)					16A	
					a	134
					b	78.5
					c	12
					d	71
Cable nominal cross-section area(mm ²)					1-2.5	

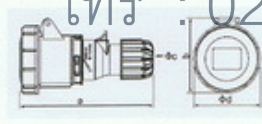

โทร : 02 550 9555

ราคาข้างต้นสามารถเปลี่ยนแปลงได้โดยไม่ต้องแจ้งให้ทราบล่วงหน้า

HTN industrial connector IP67 Watertight

HTN2141	16A	3P+E	Price: 260฿(บาท)	Earth contact position	6h
				pole	4
				Voltage	380-415V
				Dimension(mm)	16A
				a	138
				b	85
				c	12
				d	79
				Cable nominal cross-section area(mm ²)	1-2.5

HTN2151	16A	3P+N+E	Price: 290฿(บาท)	Earth contact position	6h
				Pole	5
				Voltage	220 – 380V 240 – 415V
				Dimension(mm)	16A
				a	146
				b	93
				c	12
				d	86.5
				Cable nominal cross-section area(mm ²)	1-2.5

HTN2231	32A	2P+E	Price: 330฿(บาท)	Earth contact position	6h
				Pole	3
				Voltage	220-250V
				Dimension(mm)	32A
				a	166
				b	98
				c	17
				d	93.5
				Cable nominal cross-section area(mm ²)	2.5-6

HTN2241	32A	3P+E	Price: 340฿(บาท)	Earth contact position	6h
				Pole	4(3P+E)
				Voltage	380-415V
				Dimension(mm)	32A
				a	166
				b	98
				c	17
				d	93.5
				Cable nominal cross-section area(mm ²)	2.5-6

ราคาข้างต้นสามารถเปลี่ยนแปลงได้โดยไม่ต้องแจ้งให้ทราบล่วงหน้า



บริษัท ซีที อีเล็คทริค ซัพพลาย จำกัด
CT ELECTRIC SUPPLY CO., LTD.

โทร : 02-550-9555

HTN industrial connector IP67 Watertight

HTN2251	32A	3P+N+E	Price: 410฿(บาท)	Earth contact position	6h
				Pole	5
				Voltage	220 – 380V 240 – 415V
				Dimension(mm)	32A
				a	171
				b	104
				c	17
				d	99.5
				Cable nominal cross-section area(mm ²)	2.5-6

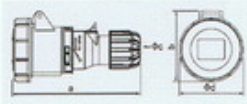

HTN2331	63A	2P+E	Price: 950฿(บาท)	Earth contact position	6h
HTN2341	63A	3P+E	1100฿(บาท)	Pole	3/4/5
HTN2351	63A	3P+N+E	1200฿(บาท)		
				Dimension(mm)	63A
				a	271
				b	115
				c	30
				d	109
				Cable nominal cross-section area(mm ²)	6-16

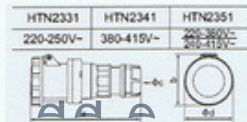

HTN2441	125A	3P+E	Price: 4000฿(บาท)	Earth contact position	6h
HTN2451	125A	3P+N+E	4600฿(บาท)	Pole	4/5
				Dimension(mm)	125A
				a	305
				b	115
				c	44.5
				d	130
				Cable nominal cross-section area(mm ²)	16-50

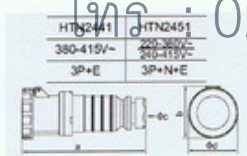

บริษัท ซีที อีเลคทริก ซัพพลาย จำกัด
CTELECTRIC SUPPLY CO., LTD.

โทร : 02 550 9555

ราคาข้างต้นสามารถเปลี่ยนแปลงได้โดยไม่ต้องแจ้งให้ทราบล่วงหน้า

HTN sloping panel sockets IP67 Watertight

HTN3131	16A	2P+E	Price: 190฿(บาท)	Earth contact position	6h
HTN3231	32A	2P+E	260฿(บาท)	Pole	3
				Voltage	220-250V
				Dimension(mm)	16A 32A
				a	75.5 75.5
				b	86.5 86.5
				c	61 61
				d	61 61
				e	41 52.5
				f	45 49.5
				g	64 64
				h	35 35
				i	38 38
				R	32 32
				r	7 7
				Cable nominal cross-section area(mm ²)	1.5-4 2.5-10

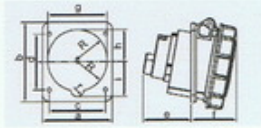

HTN3141	16A	3P+E	Price: 220฿(บาท)	Earth contact position	6h
HTN3241	32A	3P+E	290฿(บาท)	Pole	4
				Voltage	380-415V
				Dimension(mm)	16A 32A
				a	75.5 75.5
				b	86.5 86.5
				c	61 61
				d	61 61
				e	41.5 52.5
				f	46 49.5
				g	64 64
				h	35 35
				i	38 38
				R	32 32
				r	7 7
				Cable nominal cross-section area(mm ²)	1.5-4 2.5-10



บริษัท ซีที อิเล็กทริก ซัพพลาย จำกัด
HTN ELECTRIC SUPPLY CO., LTD.

โทร : 02 550 9555

ราคาข้างต้นสามารถเปลี่ยนแปลงได้โดยไม่ต้องแจ้งให้ทราบล่วงหน้า

HTN sloping panel sockets IP67 Watertight

HTN3151	16A	3P+N+E	Price: 260฿(บาท)	Earth contact position	6h
HTN3251	32A	3P+N+E	350฿(บาท)	Pole	5
				Voltage	220 – 380V 240 – 415V
				Dimension(mm)	16A 32A
				a	75.5 80
				b	86.5 90
				c	61 65
				d	61 70
				e	40 51.5
				f	48 52.5
				g	64 70
				h	35 37.5
				i	38 40.5
				R	32 35
				r	7 7
				Cable nominal cross-section area(mm ²)	1.5-4 2.5-10

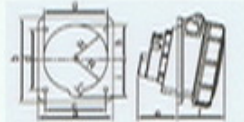

HTN3331	63A	2P+E	Price: 990฿(บาท)	Earth contact position	6h
HTN3341	63A	3P+E	1025฿(บาท)	Pole	3/4/5
HTN3351	63A	3P+N+E	1200฿(บาท)	Dimension(mm)	63A
				a	100
				b	110
				c	80
				d	85
				e	66.5
				f	77.5
				g	81
				h	42.5
				i	45.5
				R	40.5
				r	9
				Cable nominal cross-section area(mm ²)	6-25

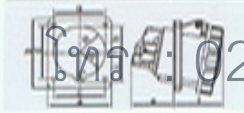

บริษัท ซีที อิเล็กทริค ซัพพลาย จำกัด
CT ELECTRIC SUPPLY CO., LTD.

โทร : 02 550 9555

ราคาข้างต้นสามารถเปลี่ยนแปลงได้โดยไม่ต้องแจ้งให้ทราบล่วงหน้า

HTN Serials panel and multiple outlet sockets IP67 Watertight

HTN3441	125A	3P+E	Price: 3250฿(บาท)	Earth contact position	6h
HTN3451	125A	3P+N+E	3400฿(บาท)	Pole	4/5
Dimension(mm)					125A
					a
					b
					c
					d
					e
					f
					g
					h
					i
					r
Cable nominal cross-section area(mm ²)					6-25

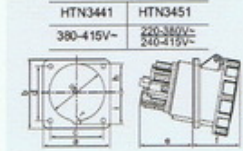

HTN1013	16A	2P+E	Price: 700฿(บาท)	Earth contact position	6h
				Pole	3
				Voltage	220-250V
Dimension(mm)					16A
					a
					b
					c
Cable nominal cross-section area(mm ²)					1-2.5
HTN1014	16A	3P+E	Price: 1000฿(บาท)	Earth contact position	6h
				Pole	4
				Voltage	380-415V
Dimension(mm)					16A
					a
					b
					c
Cable nominal cross-section area(mm ²)					1-2.5

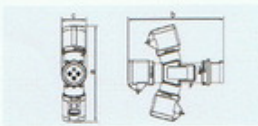
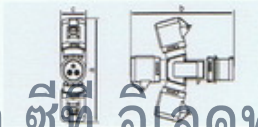

บริษัท ซีที อิเล็กทริก ซัพพลาย จำกัด
CT ELECTRIC SUPPLY CO., LTD.

โทร : 02 550 9555

ราคาข้างต้นสามารถเปลี่ยนแปลงได้โดยไม่ต้องแจ้งให้ทราบล่วงหน้า

HTN multiple outlet socket IP67 Watertight

HTN10131	16A	2P+E	Price: 850฿(บาท)	Earth contact position	6h
				Pole	3
				Voltage	220-250V
				Dimension(mm)	16A
				a	221.5
				b	220
				c	71
				Cable nominal cross-section area(mm ²)	1-2.5



HTN10141	16A	3P+E	Price: 1200฿(บาท)	Earth contact position	6h
				Pole	4
				Voltage	380-415V
				Dimension(mm)	16A
				a	238
				b	238
				c	79
				Cable nominal cross-section area(mm ²)	1-2.5



HTN60131	16A	2P+E	Price: 1550฿(บาท)	Earth contact position	6h
				Pole	3(2P+E)
				Voltage	230V
				Dimension(mm)	b
				Cable nominal cross-section area(mm ²)	H07RN-F 3G 2.5mm ² x2.2m



บริษัท ซีที อิเล็กทริค ซัพพลาย จำกัด
CT ELECTRIC SUPPLY CO., LTD.

โทร : 02 550 9555

ราคาข้างต้นสามารถเปลี่ยนแปลงได้โดยไม่/ต้องแจ้งให้ทราบล่วงหน้า

HTPZ sockets and interlock switch IP44 splash proof

HTPZ313	16A	2P+E	Price: 1040฿(บาท)	Earth contact position	6h
				pole	3
				Voltage	220-250V
				Dimension(mm)	16A
				a	167
				b	120
				c	108
				d	128
				e	102.8
				f	121
				g	71
				Cable nominal cross-section area(mm ²)	1.5-4

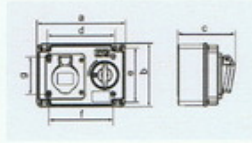

HTPZ314	16A	3P+E	Price: 1150฿(บาท)	Earth contact position	6h
				Pole	4
				Voltage	380-415V
				Dimension(mm)	16A
				a	167
				b	120
				c	111.5
				d	128
				e	102.8
				f	121
				g	71
				Cable nominal cross-section area(mm ²)	1.5-4

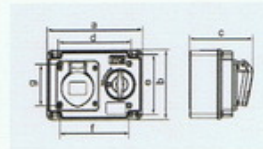

HTPZ315	16A	3P+N+E	Price: 1325฿(บาท)	Earth contact position	6h
				Pole	5
				Voltage	220 - 380V 240 - 415V
				Dimension(mm)	16A
				a	167
				b	120
				c	112
				d	128
				e	102.8
				f	121
				g	71
				Cable nominal cross-section area(mm ²)	1.5-4

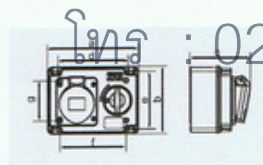



บริษัท ซีที อิเล็กทริก ซัพพลาย จำกัด
CT ELECTRIC SUPPLY CO., LTD.

โทร : 02 550 9555

ราคาข้างต้นสามารถเปลี่ยนแปลงได้โดยไม่ต้องแจ้งให้ทราบล่วงหน้า

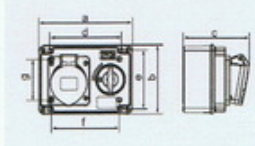
HTPZ sockets and interlock switch IP44 splash proof

HTPZ323	32A	2P+E	Price: 1300฿(บาท)	Earth contact position	6h
				Pole	3
				Voltage	220-250V
				Dimension(mm)	32A
 				a	167
				b	120
				c	118
				d	128
				e	102.8
				f	121
				g	71
				Cable nominal cross-section area(mm ²)	2.5-10

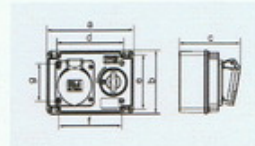
HTPZ324	32A	3P+E	Price: 1500฿(บาท)	Earth contact position	6h
				Pole	4
				Voltage	380-415V
				Dimension(mm)	32A
 				a	167
				b	120
				c	118
				d	128
				e	102.8
				f	121
				g	71
				Cable nominal cross-section area(mm ²)	2.5-10

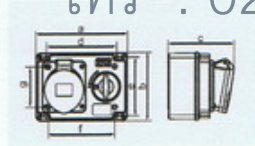
HTPZ325	32A	3P+N+E	Price: 1650฿(บาท)	Earth contact position	6h
				Pole	5
				Voltage	220 - 380V 240 - 415V
				Dimension(mm)	32A
 				a	167
				b	120
				c	120.5
				d	128
				e	102.8
				f	121
				g	71
				Cable nominal cross-section area(mm ²)	2.5-10

บริษัท ซีที อิเล็กทริก ซัพพลาย จำกัด
CT-ELECTRIC SUPPLY CO., LTD.

โทร : 02 550 9555

ราคาข้างต้นสามารถเปลี่ยนแปลงได้โดยไม่ต้องแจ้งให้ทราบล่วงหน้า

HTPZ sockets and interlock switch IP67 watertight

HTPZ1131	16A	2P+E	Price: 1800฿(บาท)	Earth contact position	6h
				Pole	3
				Voltage	220-250V
				Dimension(mm)	16A
				a	135.8
				b	248
				c	119
				d	101
				e	208
				Cable nominal cross-section area(mm ²)	1.5-4

HTPZ1141	16A	3P+E	Price: 1850฿(บาท)	Earth contact position	6h
				Pole	4
				Voltage	380-415V
				Dimension(mm)	16A
				a	135.8
				b	248
				c	119
				d	101
				e	208
				Cable nominal cross-section area(mm ²)	1.5-4

HTPZ1151	16A	3P+N+E	Price: 1900฿(บาท)	Earth contact position	6h
				Pole	5
				Voltage	220 - 380V
				Voltage	240 - 415V
				Dimension(mm)	16A
				a	135.8
				b	248
				c	119
				d	101
				e	208
				Cable nominal cross-section area(mm ²)	1.5-4



บริษัท ซีที อิเล็กทริก ซัพพลาย จำกัด
CT ELECTRIC SUPPLY CO., LTD.

โทร. 02 550 9555

ราคาข้างต้นสามารถเปลี่ยนแปลงได้โดยไม่ต้องแจ้งให้ทราบล่วงหน้า

HTPZ sockets and interlock switch IP67 watertight

HTPZ1231	32A	2P+E	Price: 1900฿(บาท)	Earth contact position	6h
				Pole	3
				Voltage	220-250V
				Dimension(mm)	32A
				a	142.5
				b	256.5
				c	119
				d	101
				e	208
				Cable nominal cross-section area(mm ²)	1.5-4

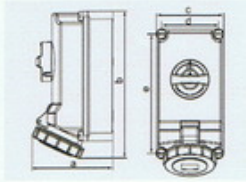

HTPZ1241	32A	3P+E	Price: 1950฿(บาท)	Earth contact position	3h
				Pole	4
				Voltage	380-440V
				Dimension(mm)	32A
				a	142.5
				b	256.5
				c	119
				d	101
				e	208
				Cable nominal cross-section area(mm ²)	2.5-10

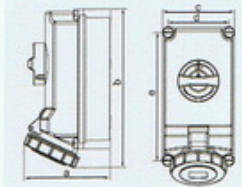

HTPZ1251	32A	3P+N+E	Price: 2050฿(บาท)	Earth contact position	6h
				Pole	5(3+N+E)
				Voltage	220 - 380V
				Voltage	240 - 415V
				Dimension(mm)	32A
				a	147
				b	256
				c	119
				d	101
				e	208
				Cable nominal cross-section area(mm ²)	2.5-10

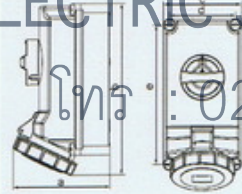

บริษัท ซีที อีเลคทริค ซัพพลาย จำกัด
CT ELECTRIC SUPPLY CO., LTD.

โทร : 02 550 9555

ราคาข้างต้นสามารถเปลี่ยนแปลงได้โดยไม่ต้องแจ้งให้ทราบล่วงหน้า