

Chemical Analysis - Filtration Consumables -



- Syringe Filters Manufacturer
- Vials/Caps/Septa Manufacturer
- Lab Consumables Manufacturer
- Laboratory Instruments



Bacteriological
Petri Dishes



HPLC Vials



Vacuum Pump
Filtration System



NEW !! Pipette



Caps & Septa



4mm/13mm/25mm
Syringe Filters



Centrifuge Tubes



Membrane Filter
Glass Microfiber Filter



ISO 13485

VISIT US

 www.finetech-filters.com
www.finetech-filter.com.vn

ABOUT US

Constantly researching and innovating...

Finetech Research and Innovation Corporation was established in 1999 and has been engaged in the gas and fluid filtration used in laboratories and the medical fields for many years. We concentrate on the researching, developing, and manufacturing of lab filters such as syringe filters, 50mm air/vent filters, pipette filters, gas analyzer filters, and customized filters.

In 2004, we were the first manufacturer of transducer protectors used in dialysis. In 2017, sales of transducer protectors had reached to over 30 million pieces/year. Our high quality and ISO 13485 certified transducer protectors has kept our customers satisfied for more than 14 years.

Manufactured in 2010, our syringe filter is designed to provide efficient filtration of aqueous and organic solutions. It can be used to remove particles from a sample prior to analysis by HPLC, for the filtration of gases, and for the removal of bacteria from a sample. Syringe filters are widely used in environmental, pharmaceutical, biotechnology, and agricultural testing laboratories.

In 2015, Finetech designed and manufactured caps, septa, and samples vials used in chromatography. We supply HPLC consumables to the global chromatography community in over 36 countries. We constantly innovate with releases of new lab consumables and medical devices every year. Some of the other products we manufacture are sterile syringe filter, membrane filters, centrifuge tube, glass microfiber filters, vacuum filtration system, and QuEChERS. To find out more, please visit our website "www.finetech-filters.com".

History

- 2021 Developed Racked Filters Tips, PCR Supplies, Cell Culture Supplies and Petri Dishes
- 2020 Produced Disposable Medical Masks
- 2019 Produced Bottle Top Filter Unit
- 2018 Researched and developed QuEChERS
- 2017 Produced 15mL & 50mL centrifuge tubes (sterile & non-sterile)
- 2016 New product launched – sterile filtration cup
- 2015 Achieved ISO 9001. Received award of Conventional Industry Technology Development for Medical grade septa
- 2014 Started producing sterile syringe filters
- 2012 Produced the 1st 50mm air vent filters
- 2010 Produced the 1st syringe filters manufactured in a cleanroom
- 2008 Developed transducer protectors. 1st manufacturer in Asia
- 2005 Awarded the Medical Device award from Taiwan Government
- 1999 Finetech Research and Innovation Corporation established



Taiwan Factory



China Office

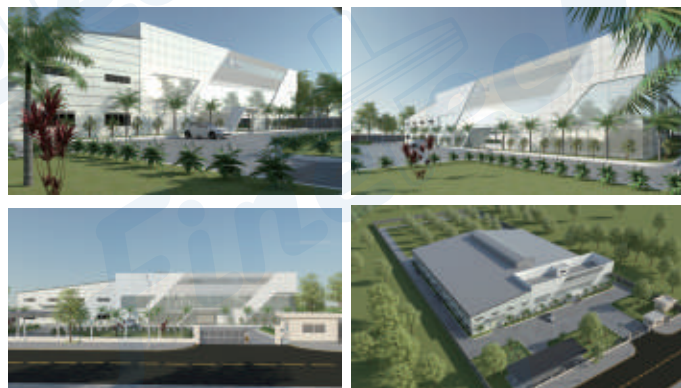

Vietnam Factory

Product Timeline



1999

Finetech Research and Innovation Corporation established.



2008

Developed autoclavable transducer protector.



2012

Produced the first 50mm air/vent filters in Taiwan.



2015

Started production of vials for chromatography and environmental analysis.



2016

New product launched – sterile filtration cup.



2018

Researched and developed QuEChERS kit



2020

Disposable Medical Masks

2004

Developed transducer protectors. Was the first manufacturer in Asia.



2010

Produced the first syringe filters manufactured in a cleanroom in Taiwan.(PureTech)



2014

Started producing sterile syringe filters.



2015

Vacuum Pump & Vacuum Filtration System (Stainless Steel manifold)



2017

Produced 15mL & 50mL centrifuge tubes (sterile & non-sterile)

2019

Bottle Top Filter Unit
100ml Funnel Filter



2021

Rack Filter Tips & PCR Supplies
Cell Culture Series
Petri Dish



Contents

A. Syringe Filters/Air Filters

A1. Syringe Filters	04
A2. Air / Vent Filters	07
A3. Pipette Filters	08
A4. Gas Analyser Filters	08
A5. Three Hole Delivery Cap	08
A6. Filter Holder	08
A7. Automated Syringe Filters	09
A8. Solvent Safety Caps	10

B. Membrane Filters

B1. Membrane Filters	12
B2. Glass Fiber Filters	12
B3. Glass Fiber for "TCLP"	13
B4. Glass Fiber for "TSS"	13
B5. Glass Fiber for "TSP"	13

C. Vacuum Filtration System

C1. Finetech® Vacuum Pump	14
C2. Finetech® Glass Fiber Filter	16
C3. Waste Container	16
C4. Filtration Set	17
C5. Bacteriological Petri Dishes	18

D. Centrifuge Tubes

D1. Centrifuge Tubes	19
D2. 50ml Digestion Vessels	19

E. Microcentrifuge Tubes

F. Disposable Transfer Pipette

G. Vials Caps&Septa

G1. 2mL Vials & Caps (8-425)	22
G2. 2mL Vials & Caps (9-425)	22
G3. 2mL Crimp-Top Vials & Caps	26
G4. Micro Insert & Shell Vials	26
G5. 4mL Vials & Caps	27
G6. 8mL & 12mL Vials & Caps	27
G7. 10mL & 20mL Screw-Thread Vials & Caps	28
G8. 10mL & 20mL Crimp-Top Vials & Caps	28
G9. 20mL Vials, Scintillation	29
G10. 20mL ~ 60mL Vials	29
G11. 9mm Plastic Micro Vials	30
G12. 9mm Glass Micro Vials	30
Tests of Caps and Septa	23~25

H. Accessories

H1. Crimping & Decrimping Tools	31
H2. Vials Racks	31

I. Other Glasswares

I 1. COD Test Tubes	32
I 2. Glass Culture Tubes	32

J. Micropipettes & Tips

J1. Micropipettes	33
J2. Pipette Tips	34

A. Syringe Filters/Air Filters

A1. Syringe Filters

A1-1 PureTech™ - Syringe Filters

- HPLC Class
- Integrity tested
- Multiple choices of membranes
- Medical grade polypropylene housing
- OEM accepted



4mm

- ▶ Housing material: PP
- ▶ Filtration area: 0.12cm²
- ▶ Process Volume: 1mL
- ▶ Hold-up Volume: <10μL
- ▶ Pressure Bar (PSI): 5.2 Bar (75)
- ▶ Highest Temp. : 45°C



13mm

- ▶ Housing Material: PP
- ▶ Filtration area: 0.65cm²
- ▶ Process Volume: 10mL
- ▶ Hold-up volume: <25μL
- ▶ Pressure Bar(PSI): 7Bar (100)
- ▶ Highest Temp. : 45°C



25mm

- ▶ Housing Material: PP
- ▶ Filtration area: 3.9cm²
- ▶ Process Volume: 100mL
- ▶ Hold-up volume: <100μL
- ▶ Pressure Bar(PSI): 5.2Bar (75)
- ▶ Highest Temp. : 45°C



❖ Ordering Information

① Membrane		② Diameter	③ Sterile	④ Pore size	⑤ Membrane characteristics	
PVDF	CA	004=4mm	N(non-sterile)	022=0.22μm	I = hydrophilic O = hydrophobic	
PTFE	PES	013=13mm		045=0.45μm		
Nylon	RC	030=25mm		100=1.0μm		
MCE	GF					
100pcs/pk						
Example: PTFE 013 N 045 I = 13mm, Hydrophilic PTFE, 0.45um						
		①	②	③	④	⑤

A1-2 MeTech™ - Syringe Filters (Color Coding)

- HPLC Class
- Integrity tested
- Easier to distinguish different membranes
- Multiple choices of membranes
- Medical grade polypropylene housing
- OEM accepted



4mm

- ▶ Housing material: PP
- ▶ Filtration area: 0.06cm²
- ▶ Process Volume: 2mL
- ▶ Pore size: 0.22, 0.45, 1.0µm



13mm

- ▶ Housing material: PP
- ▶ Filtration area: 0.65cm²
- ▶ Process Volume: 10mL
- ▶ Hold-up volume: <25µL
- ▶ Pressure Bar (PSI): 7Bar(100)
- ▶ Highest Temp. : 45 °C



33mm

- ▶ Housing material: PP
- ▶ Filtration area: 3.9cm²
- ▶ Process Volume: 100mL
- ▶ Hold-up volume: <100µL
- ▶ Pressure Bar (PSI): 5.2Bar(75)
- ▶ Highest Temp. : 45 °C

Ordering Information

① Membrane		② Diameter	③ Sterile	④ Pore size	⑤ Membrane characteristics
PVDF PTFE Nylon MCE	CA PES RC GF	X04=4mm 017=13mm 033=33mm	N(non-sterile)	022=0.22µm 045=0.45µm 100=1.0µm 300=3.0µm 500=5.0µm	I = hydrophilic O = hydrophobic
100pcs/pk					
Example: <u>PTFE</u> <u>017</u> <u>N</u> <u>045</u> <u>I</u> = 13mm, Hydrophilic PTFE, 0.45µm, Color Coding ① ② ③ ④ ⑤					

A1-3 DualTech™ - Syringe Filters



Layer 1
Glass prefilter (GF)
down to 1 µm

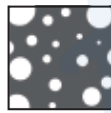

Layer 2
Membrane filter
Nylon, PVDF, PTFE, etc.
Filters down to 0.45µm or 0.2µm

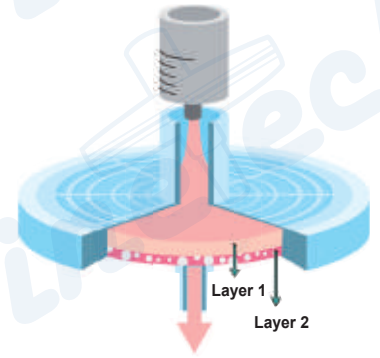
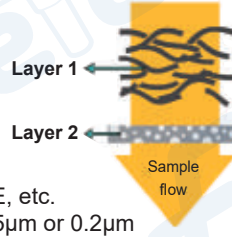

Ordering Information

① Membrane		② Diameter	③ Sterile	④ Pore size	⑤ Membrane characteristics
PVDF PTFE Nylon MCE CA PES PP RC GF	P=PP G=GF	Puretech 013=13mm 030=25mm Metech 017=13mm 033=33mm	N (Non-Sterile) S (EO/GAMMA)	022=0.22µm 045=0.45µm	I = hydrophilic O = hydrophobic
100pcs/pk					
Example: <u>PTFEG</u> <u>030</u> <u>N</u> <u>022</u> <u>O</u> = 25mm, Hydrophobic PTFE+GF, 0.22µm					
① ② ③ ④ ⑤					

A1-4 TriTech™ - Syringe Filter



Layer 1
Glass prefilter (GF)
pore size from 10-1µm



Layer 2
Glass prefilter (GF)
down to 0.7µm



Layer 3
Membrane filter
Nylon, PVDF, PTFE, etc.
Filters down to 0.45µm or 0.2µm

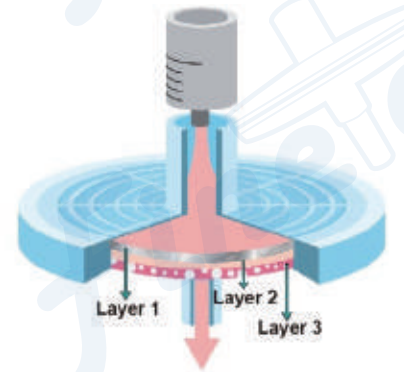
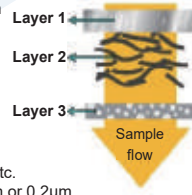

Ordering Information

① Membrane		② Diameter	③ Sterile	④ Pore size	⑤ Membrane characteristics
PVDF PTFE Nylon MCE CA PES PP RC GF	2G = GF1+GF2	030 = 25mm	N (Non-Sterile) S (EO/GAMMA)	022=0.22µm 045=0.45µm	I = hydrophilic O = hydrophobic
Example: <u>PTFE</u> <u>2G</u> <u>030</u> <u>N</u> <u>022</u> <u>O</u> = 1st Layer GF + 2nd layer GF + Hydrophobic PTFE, 25mm, 0.22µm					

A1-5 StarTech™ - Sterile Syringe Filters



13mm

- Housing material: Medical grade polypropylene
- Pore Size: 0.22um, 0.45um
- Outside diameter: 17mm
- Membrane diameter: 13mm
- High flow rate and throughput
- Low hold-up volume (less than 25µL)
- Low extractables
- Individual sterile blister pack



33mm

- Housing material: Medical grade polypropylene
- Pore Size: 0.22um, 0.45um
- Outside diameter: 33mm
- Membrane diameter: 25mm
- High flow rate and throughput
- Low hold-up volume (less than 100µL)
- Low extractables
- Individual sterile blister pack

Ordering Information

① Membrane		② Diameter	③ Sterile	④ Pore size	⑤ Membrane characteristics
PVDF PTFE Nylon MCE	CA PES RC GF	017=13mm 033=33mm	N (Non-Sterile) S (EO/GAMMA)	022=0.22µm 045=0.45µm	I = hydrophilic O = hydrophobic
13mm: 100pcs/pk 33mm: 100pcs/pk					
Example: <u>PVDF</u> <u>033</u> <u>S</u> <u>022</u> <u>I</u> = 33mm, PVDF membrane, Sterile, 0.22um					
①		②	③	④	⑤

A2 Air / Vent Filters



Part No.	Type 1	Type 2	Type 3	Type 4	Type 5
Model No.	PTFE050N0220 -PCA	PTFE050N0220 -PCB	PTFE050N0220 -PCC	PTFE050N0220 -PCD	PTFE050N0220 -PCE
Model No. (Sterile)	PTFE050S0220 -PCA	PTFE050S0220 -PCB	PTFE050S0220 -PCC	PTFE050S0220 -PCD	PTFE050S0220 -PCE
Inlet	1/8" NPT	Stepped Hose Barb	Stepped Hose Barb	1/2" NPT	8mm Barbed
Outlet	-	1/8" NPT	Stepped Hose Barb	Stepped Hose Barb	8mm Barbed
Membrane	50mm Hydrophobic PTFE				
Air Flow Rate	18-20 LMP @ 1kg/cm ²				
Housing Diameter	65mm				
Housing Material	Polycarbonate (Standard) or Polypropylene				
Pore Size	0.22um(Standard), 0.45um, 1.0um or other pore sizes				

OEM Accepted



▲ Autoclave air filter (Type 1)

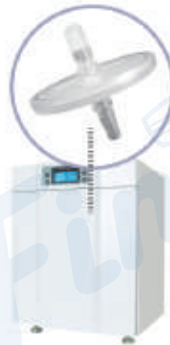

▲ CO₂ incubator air filter (Type 2)



▲ Vacuum Pump air filter (Type 3)

***Application:**

- (1) Vacuum Pump
- (2) Autoclave
- (3) Incubator
- (4) Fermentation
- (5) Bio-Reactor

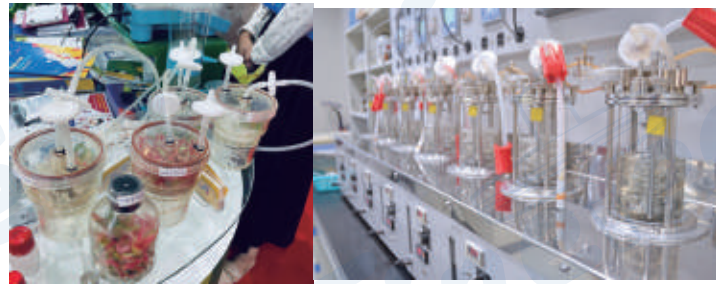

▲ Bio-reactor/ Fermentation air filters

A3. Pipette Filters



- ▶ Diameter: 27mm
- ▶ Model: PTFE027N1000
- ▶ Membrane: PTFE
- ▶ Housing Material: PVC
- ▶ Flow direction: single directions
- ▶ Application: Pipette Protection
- ▶ Pore Size: 0.2µm

A4. Gas Analyser Filters



- ▶ Model: FT0220
- ▶ Filter: PTFE
- ▶ Material: PVC
- ▶ Flow direction: single directions
- ▶ Pore Size: 0.2µm
- ▶ Sterilization method: E.O sterilization
- ▶ Packing: 100pcs/pk

A5. Three Hole Delivery Cap



- ▶ Finetech Bottle Cap Kit includes ((GL-45 Cap (White PTFE Body)) and two Peek Plugs
- ▶ Cap material: Polypropylene
- ▶ Cap color: Blue
- ▶ Body material: PTFE
- ▶ Body color: white
- ▶ Two 1/8" holes and one 1/16" hole for tubing
- ▶ Peek Plug Material: Polypropylene

A6. Filter Holder

❖ Specifications



Model No.	Holder-13	Holder-25	Holder-47
Materials	polypropylene		
Filter size	13mm	25mm	47mm
Filtration area	1.3cm ²	3.9cm ²	13.8cm ²
Pressure Rating (max)	2 bar		
Connections	Inlet & Outlet= Luer slip		
Autoclaving	20 minutes at 121°C		

A7. Finetech® Automated Certified Syringe Filters

◆ Ideal for HPLC and UPLC automated sample processing and sample clarification

- High flow rate : available with multilayer membranes
- High Throughput : two to four times the throughput of standard glass fiber prefilter devices.
- Superior HPLC column protection – Better retention efficiency helps extend column life
- Suitable for Automation devices – Designed to be fully compatible and reliable for use with the SOTAX and Zymark automated test systems.



Consistent Turret Advancement

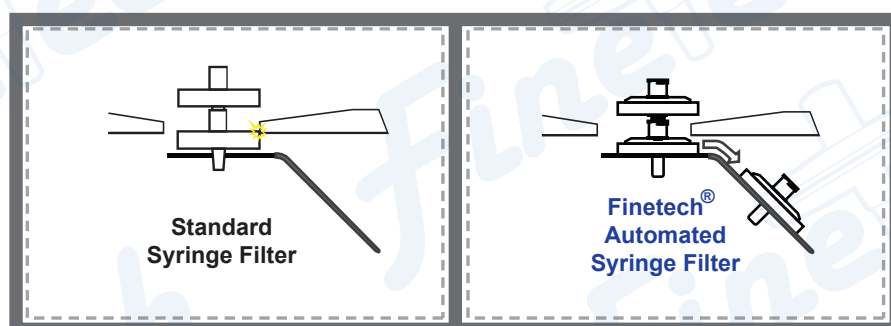

A8. Finetech® Solvent Safety Caps

A8-1 Solvent Safety Caps (GL-45)

- Protects solvents from outside contamination.
- Prevents evaporation of solvents.
- Protects the lab staff from hazardous fumes.



SES-0111



SES-0112



SES-0113



SES-0114



SES-0110

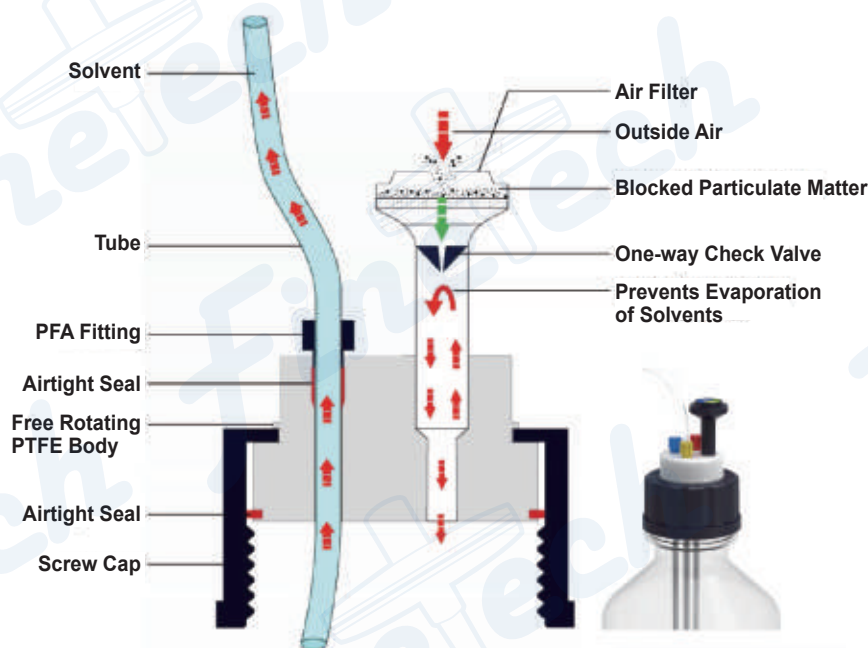

❖ Ordering Information

Model No.	Description	Packaging
SES-0111	Thread:GL45 Port No.: 1 Includes 1 vent valve with time strip	1pcs/pk
SES-0112	Thread:GL45 Port No.: 2 Includes 1 vent valve with time strip	1pcs/pk
SES-0113	Thread:GL45 Port No.: 3 Includes 1 vent valve with time strip	1pcs/pk
SES-0114	Thread:GL45 Port No.: 4 Includes 1 vent valve with time strip	1pcs/pk
SES-0115	Thread:GL45 Port No.: 5 Includes 1 vent valve with time strip	1pcs/pk
SES-0110	Replacement venting valve with time strip	1pcs/pk

A8-2 Solvent Safety Waste Caps

Purifies harmful volatile gases from the waste container.
Protects lab staff from hazardous fumes.

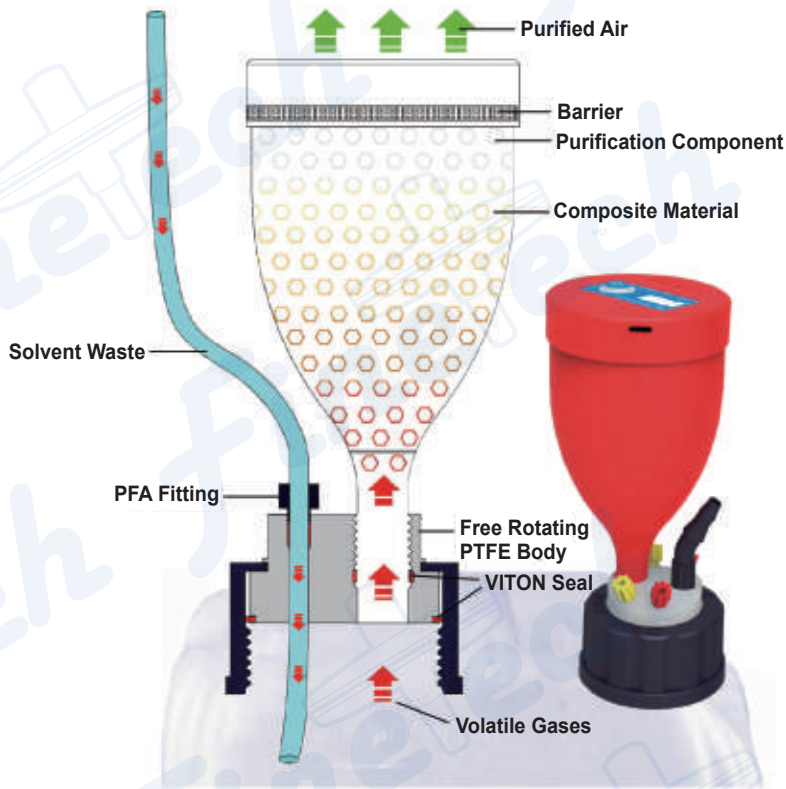

WCS-0212



WCS-0214



WCS-0224

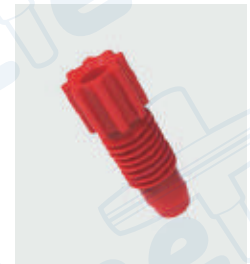

WCS-0044



WCS-0050



WCS-0060

❖ Ordering Information

Model No.	Description	Packaging
WCS-0212	Thread:GL45 Port No.: 2 With barb connector and filter	1pcs/pk
WCS-0214	Thread:GL45 Port No.: 4 With barb connector and filter	1pcs/pk
WCS-0224	Thread:S60 Port No.: 4 With barb connector and filter	1pcs/pk
WCS-0050	Activated carbon exhaust filter	1pcs/pk
WCS-0060	PP hose barb connector for 6.4-9mm tube	1pcs/pk
WCS-0044	3.2 mm PFA fitting	1pcs/pk

B. Membrane Filters

B1 Membrane Filters

FINETECH superior membrane disc filters provide consistent and reliable results. Optimized for HPLC media preparation, pharmaceuticals and cold sterilization, they are available in a variety of sizes and membranes.

Membrane sizes from disc to roll can be customized.



Ordering Information

① M	① Membrane	② Diameter	③ Sterile	④ Pore size	⑤ Membrane characteristics
Membrane Disc	PVDF PTFE Nylon MCE CA PES PP RC GF	013=13mm 025=25mm 047=47mm 090=90mm 142=142mm 293=293mm	N(non-sterile) S(EO)	022=0.22μm 045=0.45μm 100=1.0μm 300=3.0μm 500=5.0μm	I = hydrophilic O = hydrophobic
<p>Example: M-PVDF 047 N 045 I = 47mm, PVDF membrane, 0.45um</p> <p>① ① ② ③ ④ ⑤</p>					

B2 Glass Fiber Filters

Micro-glass fiber filters offer high efficiency, submicron particle retention combined with high permeability and high dust holding capacity. Micro-glass filters are made of high-purity borosilicate glass microfibers that are biologically inert and resistant to most solvents and reagents with the exception of hydrofluoric acid and highly concentrated alkali solutions.

Binder-free grades are temperature resistant to about 500°C. Grade MG 550 HA can withstand temperatures to 550°C.

Micro-Glass Fibers without Binder

Model No.	Basic Weight (g/m ²)	Thickness (mm)	Particle Retention in Liquids(μm)	Pressure Drop* (mbar)
MGA	52	0.23	1.6	38
MGB	143	0.70	1.0	95
MGC	52	0.24	1.2	55
MGD	120	0.53	2.7	140
MGF	75	0.45	0.7	120
MGG	65	0.28	1.5	30
MG 550-HA	65	0.3	1.5	-



■ Binder-free micro-glass fiber filters

*A=10cm², flow velocity 400cm²/sec

B3 Glass Fiber Filter for "TCLP"

Ordering Information

Model No.	M-GF142N070M
Typical Applications	U.S. EPA Method 1311
Size	142mm
Filter Material	Borosilicate glass without binder
Thickness	0.45mm
Nominal Pore Size	0.7µm
Pressure Drop	120 bar
Filtration Speed(mis/min)	432µm (17mils)

Cross Reference

Finetech®	Whatman	E-D Scientific Specialities	Advantec
M-GF142N070M	GF/F	151	GF 75



B4 Glass Fiber Filter for "SS" or "TSS"

Ordering Information

Model No.	M-GHA047N150M
Size	47mm
Filter Material	Borosilicate glass without binder
Nominal Pore Size	1.5µm
Thickness	360~400µm
Water Flow Rate mL/min/cm2 at 0.3 bar water	250
Air Flow Rate mL/min/cm2 at 0.7 bar(70 kPa, 10psi)	60
Maximum Operating Temperature	Air-550°C
Typical Aerosol Retention	99.98%

Cross Reference

Finetech®	Whatman	E-D Scientific Specialities	PALL
M-GHA047N150M	934-AH	161	A/E



- Standard Method 2540 D Suspended Solids

B5 Glass Filter for "TSP"

Ordering Information

Model No.	M-GHA0810N150M
Size	8" x 10" (20 x 25cm)
Filter Material	Borosilicate glass without binder
Nominal Pore Size	1.5µm
Thickness	360~400µm
Water Flow Rate mL/min/cm2 at 0.3 bar water	250
Air Flow Rate mL/min/cm2 at 0.7 bar(70 kPa, 10psi)	60
Maximum Operating Temperature	Air-550°C
Typical Aerosol Retention	99.98%

Cross Reference

Finetech®	Whatman	PALL
M-GHA0810N150M	EPM 2000	A/E



B5-1

Each filter is covered with PET pad, protecting the filter during transportation.

B5-2

With printed numbers for easy tracking.

C. Vacuum Filtration System



C1 Finetech® Vacuum Pump



VS01

- High chemical resistance
- No air pollution, maintenance free
- Built-in thermal protection
- Quiet and low vibration
- Economical Choice



VS08

- High chemical resistance
- No air pollution, maintenance free
- Built-in thermal protection
- Low vibration, high horsepower
- High vacuum, high flow rate

Ordering Information

Model No.	VS01		VS08	
	110V/60Hz	220V/50Hz	110V/60Hz	220V/50Hz
Frequency	110V/60Hz	220V/50Hz	110V/60Hz	220V/50Hz
Power(W)	70		560	
Vacuum(mmHg)	650		670	
Max Flow Rate(L/min)	22	18	110	90
Horse Power(HP)	0.1		0.75	
Noise Level(dBA)	58		61	
N.W.(kg)	4		11	
LxWxH(cm)	20x15x19		35x21x26	



VS300



VS400

- Low vibration and low noise emission
- Oil-less design, no pollution generated
- Built in thermal protection
- Compact and easy-to-carry design
- Rugged design and low maintenance required

❖ Ordering Information

Model No.	VS300		VS400	
	110V/60Hz	220V/50Hz	110V/60Hz	220V/50Hz
Frequency				
Power(W)	95		120	
Vacuum(mmHg)	660		660	
Max Flow Rate(L/min)	24	19	40	32
Horse Power(HP)	1/8		1/6	
Noise Level(dBA)	45		45	
N.W.(kg)	3.6		5.5	
LxWxH(cm)	26.7x11.3x15		33x13.5x18	

❖ Vacuum Pump Comparison

Model No.	VS01		VS300		VS400		VS08	
Frequency	110V/60Hz & 220V/50Hz							
Power(W)	70		95		120		560	
Vacuum(mmHg)	650 ± 6%		660 ± 6%		660 ± 6%		670 ± 6%	
Max Flow Rate(L/min)	22	18	24	19	40	32	110	90
Horse Power(HP)	1/8		1/8		1/6		3/4	
Noise Level(dBA)	58		45		45		61	
N.W.(kg)	4		3.6		5.5		11	
Dimensions (LxWxHcm)	20x15x19		26.7x11.3x15		33x13.5x18		35x21x26	
Vacuum Adjustment	Yes							
Thermal Protection	Yes							
Overflow Protection	No		Yes		Yes		No	

C2 Finetech® Glass Fiber Filter / Membrane Filter

Specifications

Grade	Application
MGC	For TSS or SS (Total suspended solids), 47mm Glass Fiber
MG550 HA	For TSS or SS (Total suspended solids)
M-MCE047G045I-G	47mm Pore Size:0.45µm Sterile, white membrane with black grid. Individual Pack
M-MCE047G045I-GS	47mm Pore Size:0.45µm Sterile, white membrane with black grid. Continuous Pack



C3 Waste Container

Specifications

Model No.	Capacity	Material
GM-PC01	1L	PC
GM-PC02	2L	PC
GM-PC04	4L	PC
SB1801	1.8L	PS

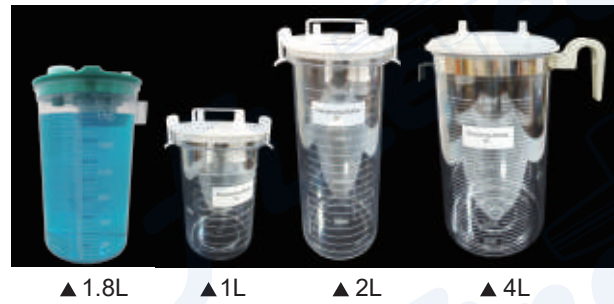

▲ 1.8L ▲ 1L ▲ 2L ▲ 4L

C4 Filtration Set

◆ C4-1 : Stainless Steel Vacuum Filtration Set

- SUS316
- Excellent Chemical Resistance
- Individual Control Valve



◀ SS-100-PP-3R

▲ SS-0292

◀ FC-MCE100G045I

Specifications

Model No.	Description	Package
SS-0289	0.3L stainless steel(316) funnel (Type A)	1set/Box
SS-1R-0289-A	1-place stainless steel(316) manifold with pressure gauge, and 0.3L stainless steel funnel (Type A)	1set/Box
SS-0290	2-place stainless steel(316) manifold, 47mm with 0.3L SS funnel*2 (Type A)	1set/Box
SS-0291	3-place stainless steel(316) manifold, 47mm with 0.3L SS funnel*3 (Type A)	1set/Box
SS-0292	6-place stainless steel(316) manifold, 47mm with 0.3L SS funnel*6 (Type A)	1set/Box
SS-1R-316	1-place stainless steel(316) manifold(Type A) with pressure gauge	1set/Box
SS-2R-316	2-place stainless steel(316) manifold(Type A)	1set/Box
SS-3R-316	3-place stainless steel(316) manifold(Type A)	1set/Box
SS-6R-316	6-place stainless steel(316) manifold(Type A)	1set/Box
FC-MCE100G045I	EZ-Tech Sterile Disposable Filter Units, 100mL	24pcs/CTN
SS-100-PP-3R	3-place stainless steel(316) manifold with EZ-Tech 47mm Sterile disposable filter units with Lid, 47mm, 100mL*3	1set/box
SS-100-PP-6R	6-place stainless steel(316) manifold with EZ-Tech 47mm Sterile disposable filter units with Lid, 47mm, 100mL*3	1set/box

◆ C4-2 : 47mm Glass Filtration Set

Type A

- Quality imported glass material, uniform thickness, no bubbles
- Good sealing performance, high flow rate, standard ground glass joint
- Autoclavable

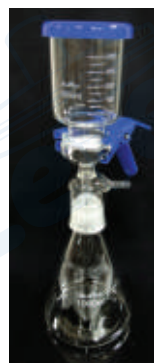

► 2000.1000.ST

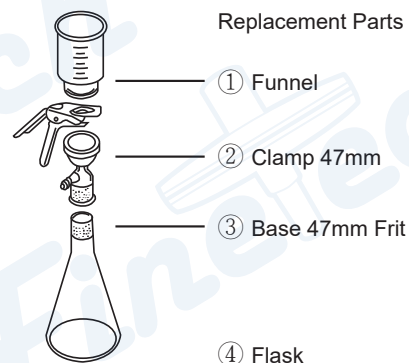

Type B

- Glass filter funnel capacity available in 300ml sizes.
- Anodized aluminum clamp.
- Flask available in 250ml, 500ml, 1000ml, and 2000ml sizes.
- Silicone plug connection. Top: ~38mm; Bottom: ~31mm; Length: ~28mm



Replacement Parts:
1. Funnel 300 ml
2. Base 47 mm Frit
3. Clamp 47 mm
5. Stopper

❖ Specifications(Type A)

Model No.	Description		Packaging
2000.250.ST	Glass Funnel:300mL Filtration Diameter: 47mm	Ground Joint Flask:250mL Size: 40/38	1set/Box 6sets/CTN
2000.500.ST	Glass Funnel:300mL Filtration Diameter: 47mm	Ground Joint Flask:500mL Size: 40/38	1set/Box 6sets/CTN
2000.1000.ST	Glass Funnel:300mL Filtration Diameter: 47mm	Ground Joint Flask:1000mL Size: 40/38	1set/Box 6sets/CTN
2000.2000.ST	Glass Funnel:300mL Filtration Diameter: 47mm	Ground Joint Flask:2000mL Size: 40/38	1set/Box 4sets/CTN
2000.3000.ST	Glass Funnel:300mL Filtration Diameter: 47mm	Ground Joint Flask:3000mL Size: 40/38	1set/Box 4sets/CTN

More information please visit our website

❖ Specifications(Type B)

Model No.	Description	Packaging
GFS-300-250	Funnel Capacity: 300ml Membrane Diameter: 47mm Flask Capacity: 250ml Flask Inner Neck Diameter: 34mm	1 set/box 6 set/carton
GFS-300-500	Funnel Capacity: 300ml Membrane Diameter: 47mm Flask Capacity: 500ml Flask Inner Neck Diameter: 34mm	
GFS-300-1000	Funnel Capacity: 300ml Membrane Diameter: 47mm Flask Capacity: 1000ml Flask Inner Neck Diameter: 34mm	
GFS-300-2000	Funnel Capacity: 300ml Membrane Diameter: 47mm Flask Capacity: 2000ml Flask Inner Neck Diameter: 34mm	

◆ C4-3 : Vacuum Driven Filter Cup

**Results:
no bacteria
growth**

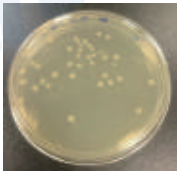
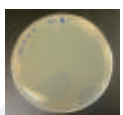
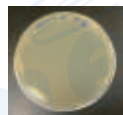
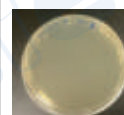
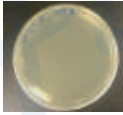
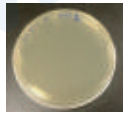
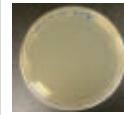

	Filter bacteria	Membrane	Finetech® Bacterial Retention		
	B. diminuta		Exp.-1	Exp.-2	Exp.-3
Sterilized Bacteria Residual Detection	Conc. : 2.6 x 10⁸ cfu/ml 	PES			
		PVDF			

❖ Characteristics

- Available with PVDF, PES, MCE, CA or Nylon
- Two pore sizes of membranes: 0.22 and 0.45µm
- Filter Diameter of 47mm with the volume size of 500mL
- Light weight and heavy wall construction
- Designed with a wide and easy access bottle mouth for efficient and stable pouring



❖ Product

- Model No. : ST-FC500
- Capacity: 500mL
- Filter Membrane: PVDF, PES
- Filter size: 47mm
- Filter pore size: 0.22, 0.45µm
- Filter area: 15.2cm²
- Residue: ≥3ml
- Package: 12pcs/box
- Resuable filter

C5 Bacteriological Petri Dishes

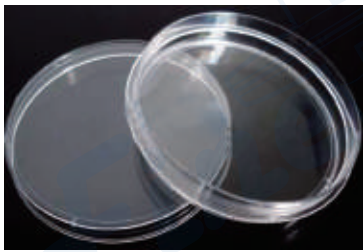

- Made of high quality polystyrene
- High degree of transparency for optimal analysis by microscopy
- Suitable for fungus, bacterial or other micro-organism culture
- Unique Vented lid for better gas exchange



Sterile Packaging

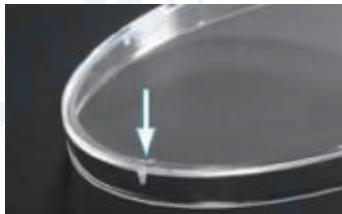

Unique Vented lid design for better gas exchange



Enhance the strength of edge

❖ Specifications

Model No.	Description	Packaging
FT506	Petri Dish, 15x90mm, Sterile	20pcs/pk, 500pcs/ctn
FT506-N	Petri Dish, 15x90mm, Non-Sterile	20pcs/pk, 500pcs/ctn
FT504	Petri Dish, 15x60mm, Sterile	26pcs/pk, 1040pcs/ctn
FT504-N	Petri Dish, 15x60mm, Non-Sterile	26pcs/pk, 1040pcs/ctn

D. Centrifuge Tubes

D1 Centrifuge Tubes



- Medical grade polypropylene
- Cap Material : HDPE
- Leakproof
- Black printed graduations
- Easy for one-handed operation
- Large white write-on area for easy marking

❖ Specifications



	15mL	50mL
Bottom Graduation Range	0.1 ~ 1mL	—
Bottom Graduation Interval	0.1mL	—
Graduation Range	1.5 ~ 14.5mL	5 ~ 47.5mL
Graduation Interval	0.5 mL	2.5 mL
Autoclavable	—	121°C
Freezable	- 20°C	- 45°C
Maximum RCF	13,000xg	9,500xg
Sterility	EO/Gamma	EO/Gamma

D2 50ml Digestion Vessels

- Made from Virgin Polypropylene
- Excellent Visibility
- Graduated to 50mL and have a total 63mL capacity



❖ Specifications

Volume (mL)L	50mL
Tube & Cap Materia	Description
Tube Bottom Shape	Flat
Tube & Cap Color	Transparent
Description	50mL Digestion Cap, 500pk

E. Microcentrifuge Tubes



❖ Features

- ▶ Constructed of high transparency PP, resistant to chemicals and low temperatures.
- ▶ Easy to open and close cap with one hand.
- ▶ DNase/RNase and pyrogen free.
- ▶ Heavy metal free
- ▶ Handles centrifuge speeds of up to 15,000 RPM.
- ▶ With clear and precise graduation on the sides.
- ▶ Frosted areas on cap and tube for easy labeling.
- ▶ Usable temperature range of -80°C - 121°C

❖ Ordering Information

◆ Microcentrifuge Tubes		
Model No.	Description	Packaging
FT301	0.2mL microcentrifuge tubes	50000pcs/CTN
FT305	0.5mL microcentrifuge tubes	20000pcs/CTN
FT306	1.5mL microcentrifuge tubes	10000pcs/CTN
FT327-3	2ml micro centrifuge tubes(snap cap) with safety cap,PP	6000pcs/CTN

F. Disposable Transfer Pipette



❖ Features

- ▶ Made of high quality non-toxic LDPE material. Used for drawing, transferring, or carrying small volumes of liquid.
- ▶ Smooth surface for easy liquid flow.
- ▶ High transparency for easy observation.
- ▶ Bendable for convenient drawing or transferring liquids in irregular or micro containers.
- ▶ Convenient and accurate for good repeatability.
- ▶ Tips can be heat-sealed liquid carrying.
- ▶ Available sterilized.

◆ Transfer Pipette		
Model No.	Description	Packaging
FT619	Non-sterile 1ml graduated transfer pipette	500pcs/pk 5000pcs/CTN
FT619-S	Sterile 1ml graduated transfer pipette	1pc/bag 500bag/box
FT626	Non-sterile 3ml graduated transfer pipette	500pcs/pk 5000pcs/CTN
FT626-s	Sterile 3ml graduated transfer pipette	1pc/bag 500bag/box 2000pcs/CTN

G. Vials, Caps & Septa

G1 2mL Vials & Caps (8-425)

- High quality
- Precise thread design
- USP TYPE I Grade
- OEM Accepted

❖ Specifications



Model No.	Size	Description
V8A	11.6x32mm	2mL small opening short screw-thread vial, clear
V8B		2mL small opening short screw-thread vial with write-on spot, clear
V8C		2mL small opening short screw-thread vial, amber
V8D		2mL small opening short screw-thread vial with write-on spot, amber
SC8A8A	Φ8mm	White PTFE/red Silicone Septa, black screw PP cap, 5.5mm centre hole
SC8AA8A		Pre-slit white PTFE/red Silicone Septa, 8mm black screw PP cap, 5.5mm centre hole
SC8F8F		Natural PTFE/white Silicone Septa, 8mm black screw PP cap, 5.5mm centre hole
S8A		White PTFE/red Silicone Septa
S8B		Red PTFE/white Silicone Septa
S8F		Natural PTFE/white Silicone Septa

G2 2mL Vials & Caps (9-425)

❖ Specifications



Model No.	Size	Description
V9A	11.6x32mm	2mL wide opening short screw-thread vial, clear
V9B		2mL wide opening short screw-thread vial with write-on spot, clear
V9C		2mL wide opening short screw-thread vial, amber
V9D		2mL wide opening short screw-thread vial with write-on spot, amber
SC9A9A	Φ9mm	White PTFE/red Silicone septa, blue screw-thread pp cap, 6mm centre hole
SC9A9A-1		Blue PP screw cap with bonded white PTFE/red Silicone Septa
SC9A9A-N (NEW)		White PTFE/red Silicone septa, Gold magnetic screw polypropylene cap, 6mm centre hole
SC9AA9A-2		Blue PP screw cap with bonded pre-slit white PTFE/red Silicone Septa
SC9F9F		Natural PTFE/white Silicone septa, blue screw-thread pp cap, 6mm centre hole
SC9F9F-C (NEW)		Nature PTFE/white Silicone septa blue screw polypropylene cap, Close-Top
SC9FF9F (NEW)		Pre-slit natural PTFE/non-slit white Silicone septa, blue screw-thread pp cap, 6mm centre hole
SC9F9F-N (NEW)		9mm Nature PTFE/white Silicone septa gold (color) screw magnetic cap, 6mm center hole
S9A		White PTFE/red Silicone septa
S9B		Red PTFE/white Silicone septa
S9F	Natural PTFE/white Silicone septa	
S9FF (NEW)	Pre-slit natural PTFE/non-slit white silicone septa	

100pcs/pk

New Design of Septa

• Pre-Slit PTFE/non-slit silicone Septa

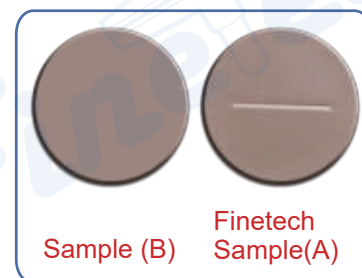
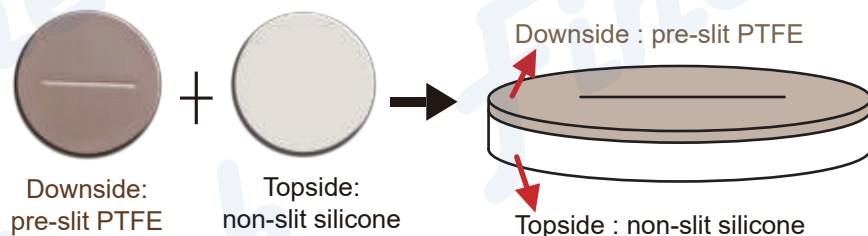

• Septa Benefit

Finetech® Sample (A) : Pre-slit PTFE / non-slit silicone septa

Sample (B) : Non-slit PTFE /silicone septa

Sample (C) : Pre-slit PTFE /silicone septa

1. Finetech® Sample (A) will not be dropped off after punching many times, as compared with Sample (B) (Fig1)
2. Finetech® Sample (A) can keep volatile solvents better than Sample (C) (Fig3)
3. Finetech® Sample (A) decreases the damages of micro-syringe
4. Finetech® Sample (A) decreases the resistance of punching more than Sample (B)
5. Finetech® Sample (A) is made of original PTFE and Silicone

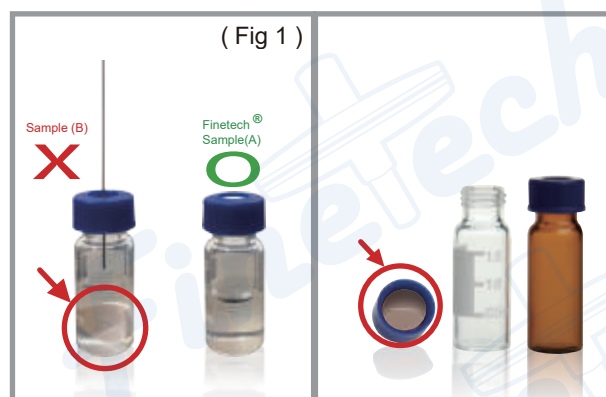

Quality Control of Caps

◆ Number on cap housing for traceability

■ Finetech(cave number)



■ Ohter brand (no cave number)



Chemical Testing

◆ Bleed Test of Septa Using HPLC Fixed Syringes

● Experimental goal:

Bleed test of septa by using HPLC fixed syringes.

1. The different brands of septa were mounted on the vial caps.
2. Use salicylic acid as standard and add 1 mL of ACN:H₂O=1:1 as solvent to the vials.
3. Analyze the solvents by HPLC-UV (n = 18).

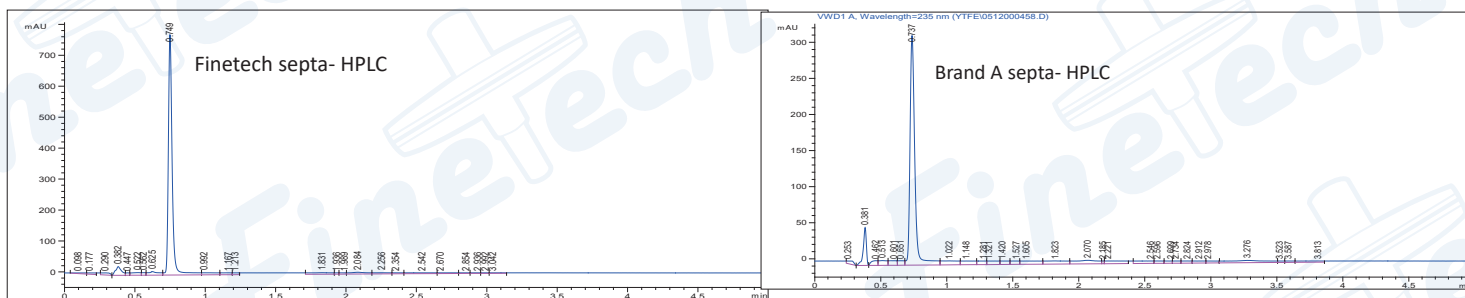

EXPERIMENTAL

Instrument	Brand A 1200 LC
Wavelength	235 nm
Mobile phase	ACN:H ₂ O=40:60
Column	Kinetex 5 μ C18 100A
Flow	1.5 mL/min
Injection size	20.0 uL
Solvent	ACN:H ₂ O=1:1

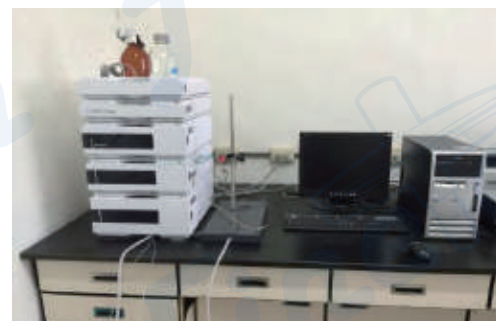

● Experimental results

1. The HPLC results show less interference and more signal area of the standard in Finetech's septa than Brand A. Therefore, Finetech's septa can be seen as being less likely to dissolve interfering compounds into the sample

	RetTime (min)	Width (min)	Area (mAU)	Height (mAU)	Area %
Finetech	0.749	0.0296	1481.08228	773.61224	69.021
Brand A	0.737	0.0386	814.18939	317.87524	49.748

2. Recovery rate of standard was 96-104%.

Test of Septa

◆ Volatility Test

◆ Punching Test

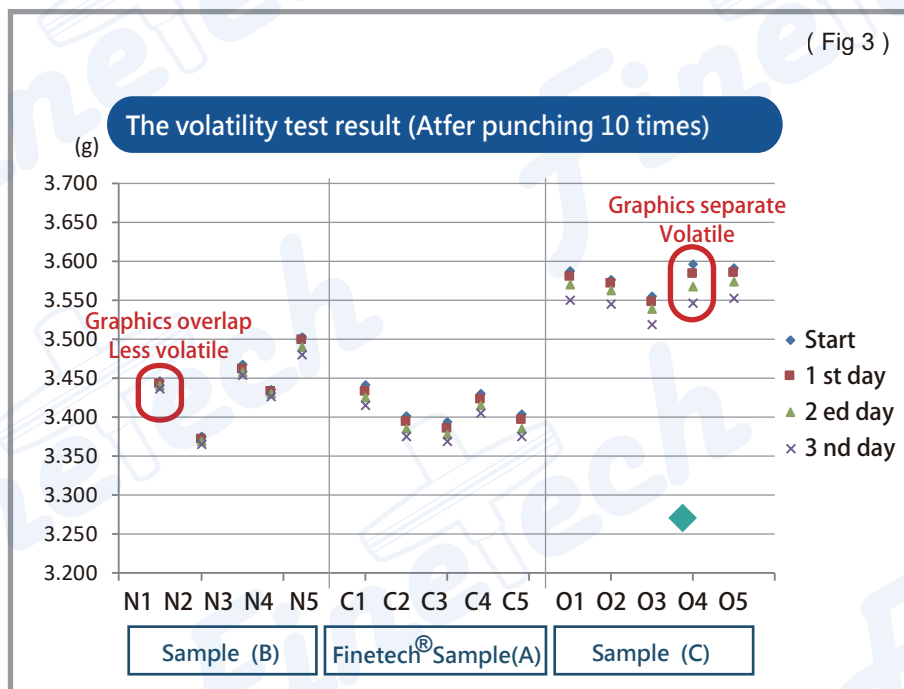

Digital Tensile Strength Test Machine

- I . Septa and caps are assembled as (Fig2)
- II . Simulator : Use digital Tensile Strength Test Machine to measure the resistance force
- III . Measure the strength of a flat needle to punch septa
- IV . Resistance force of Finetech® Sample(A) : 0.17-0.21 kgf Resistance force of Sample (B) : 0.34-0.39 kgf

Physical Testing

- **Purpose** : To test the adhesion strength between the PTFE and silicon layer. Results should exceed 19.6 N (about 2 kgf).
- **Procedure** : After bonding PTFE and silicon, let stand for 1 minute. Take 10 pcs and test the peel strength with tensile testing machine set at 50mm/min load rate.



Results:

	1	2	3	4	5	6	7	8	9	10
Peel Strength (N)	28	23.2	21	26.3	38.5	24.2	27.9	32	27.1	28.4

- **Conclusion:** The peel strength test conducted on the PTFE/silicon septa material shows to exceed the criteria of 19.6 newtons.

G3 2mL Crimp-Top Vials & Caps

- Compatible with Shimadzu, Varian, and other autosampler
- Caps are made of high quality aluminum



Specifications

Model No.	Size	Description
V11A	11.6x32mm	2mL wide opening crimp-top vial, clear
V11B		2mL wide opening crimp-top vial with write-on spot, clear
V11C		2mL wide opening crimp-top vial, amber
V11D		2mL wide opening crimp-top vial with write-on spot, amber
SC11A11B	Φ11mm	Pre-slit white PTFE/red Silicone septa, 11mm crimp-top aluminum cap, 5.5mm centre hole
SC11A11B-N		White PTFE/red Silicone septa, 11 mm crimp -top magnetic cap, 5.5 mm centre hole
SC11A11A	Φ12x32mm	White PTFE/red Silicone septa, 11mm crimp-top aluminum cap, 5.5mm centre hole
SC11F11A-1		Non-slip Nature PTFE/White Silicone septa, 11 mm crimp -top aluminum cap, 5.5 mm centre hole
SC11AA11A		Pre-slit white PTFE/red Silicone septa, 11mm crimp-top aluminum cap, 5.5mm centre hole

100pcs/pk

G4 Micro Insert & Shell Vials



Specifications

Model No.	Size	Description
IPA150	29x5mm	150µL Insert with mandrel interior and polymer feet, for ND8 Vials
IPB250	29x5.7mm	250µL Insert with mandrel interior and polymer feet, for ND9 Vials
IPB250-P	29x5.7mm	250µL Plastic Insert with mandrel interior and polymer feet, for ND9 Vials (200pcs/pk)
IA250	31x5mm	250µL Micro-Insert, clear glass, flat bottom, for ND8 Vials
IB300	31x6mm	300µL Micro-Insert, clear glass, flat bottom, for ND9 Vials
V18A	8.2x40mm	1mL shell vials, 1st hydrol glass, clear, 8mm PE-Plug, soft, without insertion

100pcs/pk

G5 4mL Vials & Caps



Specifications

Model No.	Size	Description
V13A	15x45mm	4mL screw-thread vial, clear
V13B		4mL screw-thread vial, clear with write-on spot
V13C		4mL screw-thread vial, amber
V13D		4mL screw-thread vial, with write-on spot, amber
SC13D13B	Φ13mm	Natural PTFE/natural silicone septa, 13mm black screw PP cap, closed-top
SC13A13A		White PTFE/red Silicone septa, 13mm black screw PP cap, 8.5mm centre hole
SC13AA13A		Pre-slit white PTFE/red Silicone septa, 13mm black screw PP cap, 8.5mm centre hole
S13A		White PTFE/red Silicone septa

100pcs/pk

G6 8mL & 12mL Vials & Caps



Specifications

Model No.	Size	Description
V08A	17x60mm	8mL screw-thread vial, clear, borosilicate
V08C	17x60mm	8mL screw-thread vial, amber, borosilicate
V12A	18.75x65mm	12mL screw-thread vial, clear, borosilicate
V12C	18.75x65mm	12mL screw-thread vial, amber, borosilicate
SC15D15B	15.5x10mm	Black Closed-top Cap with Natural PTFE/White Silicone septa

100pcs/pk

GC Headspace Vials

G7 10mL & 20mL Screw-Thread Headspace Vials & Caps

- Compatible with Shimadzu Varian, and other autosampler
- Caps are made of high quality aluminum



Specifications

Model No.	Size	Description
VA101A	22.5x46mm	10mL Clear precision screw-thread vial, round bottom
VA201A	22.5x75.5mm	20mL Clear precision screw-thread vial, round bottom
SACA00A	Φ18mm	Blue PTFE/white silicone septa, 18mm magnetic precision screw-thread metal cap, 8mm centre hold

100pcs/pk

G8 10mL & 20mL Crimp-Top Headspace Vials & Caps





Specifications

Model No.	Size	Description
VH10A	22.5x46mm	10mL crimp headspace clear vial, flat bottom
VH10B	22.5x46mm	10mL crimp headspace amber vial, flat bottom
VH20A	22.5x75.5mm	20mL crimp headspace clear vial, flat bottom
VH20B	22.5x75.5mm	20mL crimp headspace amber vial, flat bottom
S20A	22x1.5mm	Nature PTFE/nature silicone speta
C20A	Φ20mm	Crimp-top aluminum cap, 10mm centre hole
SC20B20A	Φ20mm	Natural PTFE/Natural silicone septa, 20mm crimp-top aluminum cap, 10mm centre hole
SBC20B20B	Φ20mm	Natural PTFE/Natural silicone speta, 20mm crimp-top blue magetic aluminum cap, 10mm centre hole

100pcs/pk

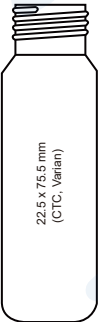
Choosing the right Headspace Vials

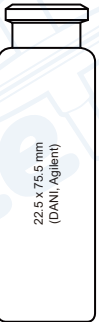
			
VA101A	VA201A	VH10A VH10B	VH20A VH20B
CTC Combi PAL (Varian, Gerstel, Atas, Shimadzu), PerkinElmer*, Agilent	CTC Combi PAL (Varian, Gerstel, Atas, Shimadzu), PerkinElmer*, Agilent	Agilent, Carlo Erba, DANI, Fisons	Agilent, Carlo Erba, DANI, Fisons

Headspace Vials and Closures

Headspace vials are available in both 10mL and 20mL capacities, flat or rounded bottom.

The 20mm crimp caps provide a consistently secure seal.

- Choice of crimp or screw top vials
- Beveled top for maximum secure seal
- Two neck lengths available
- Choice of a pressure safety release cap at 45 psi
- Available in flat or rounded bottom designs

Storage Vials: EPA/Storage/VOA Vial



G9 20mL Vials, Scintillation

❖ Specifications

Model No.	Size	Description
V20A22ET	27x58mm	20mL screw-thread vial, clear glass (22-400)
V20B22ET		20mL screw-thread vial, amber glass (22-400)
V20A24ET		20mL screw-thread vial, clear glass (24-400)
SC22WPEET	Φ22mm	White closed top PP cap + 22mm white PE septa (22-400)
SC22BPEET		Black closed top PP cap + 22mm white PE septa (22-400)
SC24WPEET	Φ24mm	White closed top PP cap + 24mm white PE septa (24-400)
SC24BPEET		Black closed top PP cap + 24mm white PE septa (24-400)

100pcs/pk

G10 20mL ~ 60mL Vials

- PTFE septa can resist organic solvents
- Caps are made of high quality polypropylene

❖ Specifications

V20A	27x58mm	20mL screw-thread vial, clear glass (24-400)
V20B		20mL screw-thread vial, amber glass (24-400)
V30A	27x75mm	30mL screw-thread vial, clear glass (24-400)
V40A	27x95mm	40mL screw-thread vial, clear glass (24-400)
V40B		40mL screw-thread vial, amber glass (24-400)
V60A	27x140mm	60mL screw-thread vial, clear glass (24-400)
V60B		60mL screw-thread vial, amber glass (24-400)
SC22A22A	Φ22x3mm	Natural PTFE/Natural Silicone septa 22x3mm, 22mm white screw PP cap, 15mm centre hole (24-400)
SC22A22B	Φ22x1.5mm	Natural PTFE/Natural Silicone septa 22x1.5mm, 22mm white screw PP cap, closed-top (24-400)
SC22A22C	Φ22x3mm	Natural PTFE/Natural Silicone septa 22x3mm, 22mm black screw PP cap, 15mm centre hole (24-400)
SC22A22D	Φ22x1.5mm	Natural PTFE/Natural Silicone septa 22x1.5mm, 22mm black screw polypropylene cap, closed-top (24-400)
S22A-I	Φ22x3mm	Natural PTFE/Natural Silicone septa 22x3mm
S22A-II	Φ22x1.5mm	Natural PTFE/Natural Silicone septa 22x1.5mm

100pcs/pk

Why Choose VOA Vials?

VOA vials are specifically designed for use with volatile organic compounds. They are available in both clear and amber borosilicate glass and have a temperature range of -40°C to 125°C.

- Ready to use caps: no time-consuming assembly
- No contamination of the liner that is normally caused by manual assembly
- Available as closed top screw or with centre hole in white or black 24-400 caps
- Broad variety of different septa materials for almost all applications



G11 9mm Plastic Micro Vials



Product

- ▶ Product Name: 9mm Plastic Micro Vial
- ▶ Maximum capacity: 300µL
- ▶ Recommended capacity: 250µL
- ▶ Bottle height: 32mm
- ▶ Thread diameter: 9mm
- ▶ Bottom diameter: 11.6mm
- ▶ Material: Polypropylene (PP)
- ▶ Packing quantity: 100 pcs / box

Specifications

Model No.	Size	Description
VP9A	9x11.6mm	0.3mL Short thread micro injection sample vials, clear, Polypropylene
VP9C	9x11.6mm	0.3mL Short thread micro injection sample vials, amber, Polypropylene

100pcs/pk

G12 9mm Glass Micro Vials



Product

- ▶ Product Name: 9mm Glass Micro Vial
- ▶ Maximum capacity: 300µL
- ▶ Recommended capacity: 250µL
- ▶ Bottle height: 32mm
- ▶ Thread diameter: 9mm
- ▶ Bottom diameter: 11.6mm
- ▶ Material: borosilicate
- ▶ Packing quantity: 100 pcs / box

Specifications

Model No.	Size	Description
VL9A	9x11.6mm	300µL thread fusion type vials, clear, borosilicate
VL9B	9x11.6mm	300µL thread fusion type vials, clear, write-on spot, borosilicate
VL9C	9x11.6mm	300µL thread fusion type vials, amber, borosilicate
VL9D	9x11.6mm	300µL thread fusion type vials, amber, write-on spot, borosilicate

100pcs/pk

H. Accessories

Hand Crimpers & Vial Racks

H1 Crimping and Decrimping Tools



Specifications

Model No.	Description
HD11-S	hand crimper, with 11mm crimp seals for 2mL Crimp Top Vial
HD11-O	hand decapper, with 11mm crimp open for 2mL Crimp Top Vial
HD20-S	hand crimper, with 20mm crimp seals for 20mL Crimp Top Vial
HD20-O	hand decapper, with 20mm crimp open for 20mL Crimp Top Vial

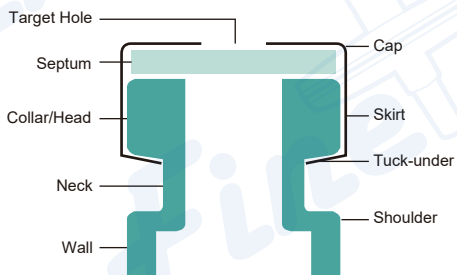

Correctly Crimped Vial

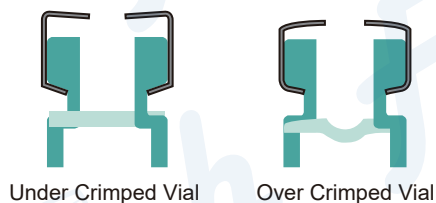

- Painted, plated and coated for maximum corrosion resistance
- Adjustable stop for optimal sealing performance
- Textured handles for excellent grip
- Controlled, low-effort method for removing caps, reducing both sample spillage and breakages

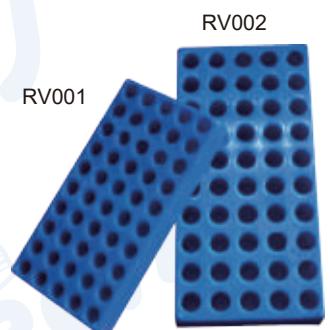

H2 Vials Racks

- 50 slots
- For 2mL or 4mL vials
- Made of polypropylene
- Easy handling and transportation of sample vials
- Solidly constructed for stable standing position

Specifications

Model No.	Description
RV001	2mL vials rack(PP), 18.7x9.7x2.1 cm, 50 slots
RV002	4mL vials rack(PP), 23.6x11.6x2.8 cm, 50 slots

Other Glasswares

1 COD Test Tubes

For use in Chemical Oxygen Demand (COD) analysis to determine the amount of organic compounds in a water source.

High optical glass quality for accurate colorimetric analysis.



❖ Specification

- ▶ Capacity: 10mL
- ▶ Max Capacity: 12mL
- ▶ Height: 10±0.02cm
- ▶ Diameter: 1.58±0.02cm
- ▶ Neck Inner Diameter: 0.95±0.02cm
- ▶ Neck Outer Diameter: 1.50±0.02cm

❖ Ordering Information

Model No.	Description	Package
Tube-T10R	Glass TestTube(screw top),Rounded Bottom 16mmX100mm, 250pcs/pk for C.O.D (5.0 Schott material)	600pcs/CTN
Tube-T10F	Glass TestTube(screw top),flat Bottom 16mmX100mm, 100pcs/pk (5.0 Schott material)	600pcs/CTN
Tube-T10R-C	PP screw cap with PTFE setpa for 16X100mm Glass Tube	600pcs/CTN
Tube-T10R-C1	PTFE/butyl rubber/PTFE sep tatransparent PC cap for Tube-T10R	600pcs/CTN

2 Disposable Glass Culture Tubes

- Constructed of borosilicate 3.3 glass.
- Flat mouth or with rim available.
- With or without graduation.
- Flat bottom or with round bottom.



❖ Ordering Information

Model No.	Description	Package
Tube-G12075	Glass Test Tube(culture), 12mmX75mm	2000pcs/CTN
Tube-G12100	Glass Test Tube(culture), 12mmX100mm	2000pcs/CTN
Tube-G13100	Glass Test Tube(culture), 12mmX100mm	2000pcs/CTN
Tube-G16100	Glass Test Tube(culture), 16mmX100mm	1000pcs/CTN
Tube-G15150	Glass Test Tube(culture), 15mmX150mm	1000pcs/CTN
Tube-G16125	Glass Test Tube(culture), 16mmX125mm	1000pcs/CTN
Tube-G16150	Glass Test Tube(culture), 16mmX150mm	1000pcs/CTN

More information please visit our website

J. Micropipettes & Tips

J1 Micropipettes



❖ Key Features

- ▶ Available in the range of 0.1uL to 10mL
- ▶ Autoclavable 121°C (20min)
- ▶ Corrosion-resistant ceramic-piston and ejector

❖ Product Description

Finetech's variable volume micropipettes are products of intensive ergonomic and operational studies and the application of modern innovative materials. They are the perfect manual pipettes for demanding laboratory applications and scientists who prefer central pipetting buttons. The micropipettes provide all of the features required by users working in the life sciences field. Robust, one-handed operation, easy to calibrate, completely autoclavable, with high precision and reliability.

The S Series micropipettes offers a ceramic piston for increased durability and corrosion resistance over the traditional plastic or metal pistons.

❖ Lightweight-Accurate-Low force

The piston-operated micropipettes provides maximum versatility and optimum quality over the entire volume range. There are 8 single-channel pipettes available in the 0.1uL to 10mL range in variable volume.

❖ Features

- ▶ Large central pipetting button and separate ejection function.
- ▶ One-handed operation for both right- and left-handers.
- ▶ Completely autoclavable at 121°C (20min).
- ▶ Volume-change protection.
- ▶ Vertical 4-position volume display, allows a clear view in either hand.
- ▶ Short stroke of only 12.5mm to reduce the risk of RSI (Repetitive Strain Injury).
- ▶ Corrosion-resistant ceramic-piston and ejector.
- ▶ Optimized standard design for the tip cone allows compatibility with a wide range of tips.

58
crosses
material
use of the
antibacterial
waterproof



Easy to calibrate



One-handed operation



4-position volume display



Anticorrosion ceramic piston



❖ Ordering Information

Model No.	Description	Package
MS-1H	Volume: 0.1-1µl, Increment 0.001µl A*≤±%: 2, CV*≤%: 1.2	1pcs/box
MS-10H	Volume: 0.5-10µl, Increment 0.01µl A*≤±%: 1, CV*≤%: 0.5	1pcs/box
MS-20H	Volume: 2-20µl, Increment 0.02µl A*≤±%: 0.8, CV*≤%: 0.4	1pcs/box
MS-50H	Volume: 5-50µl, Increment 0.05µl A*≤±%: 0.6, CV*≤%: 0.2	1pcs/box
MS-100H	Volume: 10-100µl, Increment 0.1µl A*≤±%: 0.6, CV*≤%: 0.2	1pcs/box
MS-200H	Volume: 20-200µl, Increment 0.2µl A*≤±%: 0.6, CV*≤%: 0.2	1pcs/box
MS-1000H	Volume: 100-1000µl, Increment 1µl A*≤±%: 0.6, CV*≤%: 0.2	1pcs/box
MS-5000H	Volume: 500-5000µl, Increment 5µl A*≤±%: 0.6, CV*≤%: 0.2	1pcs/box
MS-10000H	Volume: 1000-10000µl, Increment 10µl A*≤±%: 0.6, CV*≤%: 0.2	1pcs/box

J2 Pipette Tips

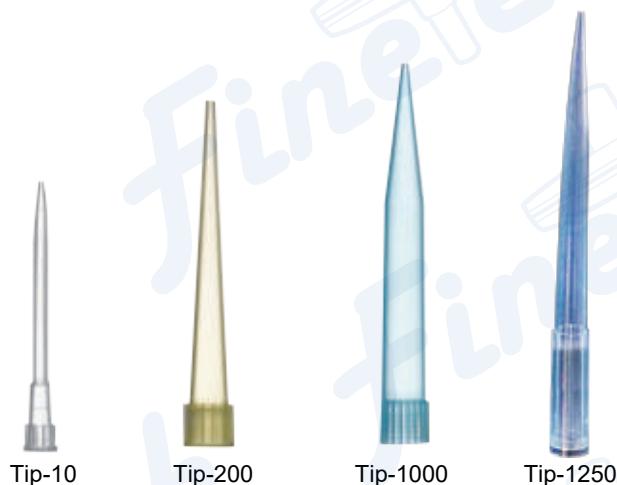

Tip-10

Tip-200

Tip-1000

Tip-1250

Model NO.	Description	Packaging
Tip-10	Clear tip for 10ul non sterile	1000pcs/bag, 20000pcs/cs
Tip-200	Yellow tip for 200ul non sterile	1000pcs/bag, 20000pcs/cs
Tip-1000	Blue tip for 1000ul non sterile	1000pcs/bag, 5000pcs/cs
Tip-1250	Blue tip for 1250ul non sterile	1000pcs/bag, 5000pcs/cs
Tip-5000-A	clear tip for 5ml non sterilen, for Dragon, Eppendorf	300pcs/bag 3000pcs/cs
Tip-5000-B	Clear tip for 5ml non sterile, for Finetech, Brand, Finn	300pcs/bag 3000pcs/cs
Tip-5000-C	Clear tip for 5ml non sterile, for CAPP, Rainin, Gilson	300pcs/bag 3000pcs/cs
Tip-10000	Clear tip for 10ml non Sterile 15mm*160mm for Finetech,Gilson, Brand, Eppendorf, Dragon, Axygen, Labsystem, Ranin, Satorius	100pcs/bag 1000PCS/cs

FINETECH RESEARCH & INNOVATION CORP.



US

Company Profile

- Since 1999, Finetech Research and Innovation Corporation has been manufacturing and supplying laboratory consumables to various types of labs all over the world. With exports to over 40 countries, Finetech has become one of the leading provider for environmental, pharmaceutical, biological, and other testing laboratories
- Finetech began with the research & development and manufacturing of syringe filters and other filtration products. In keeping with our core principle of innovation, Finetech has expanded their product line to include lab equipment and other supplies to meet the needs of their customers.
- Finetech follows the principles of quality over quantity and good services for all. The importance of quality can be seen in the use of quality imported materials and equipment, the use of a cleanroom, and the strict quality control standards.

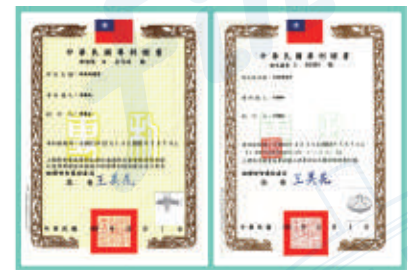

Contact us

FINETECH RESEARCH & INNOVATION CORP.

- Sample vials
- Glass fiber filters
- Biochemical supplies
- Syringe filters
- Air filters



China Office/factory

TAIWAN OFFICE

Vietnam Office/factory

Taipei

Hsinchu

Taichung

Changhua

Kaohsiung

✉ sales@finetech-filters.com ☎ +886-977-216-648

line/whatsapp: +886-977-216-648 (Patrick)