

# 01

LABORATORY  
GLASS BOTTLES  
AND ACCESSORIES

---

# LABORATORY GLASS BOTTLES AND ACCESSORIES

## Thoroughly proven – universally applicable

DURAN® laboratory glass bottles impress because of their outstanding properties. For more than forty years of production, the bottles have been consistently developed and improved. Thanks to this experience, the DWK Life Sciences offers quality that remains unmatched.

With numerous variants and the comprehensive original equipment from DURAN®, a broad range of high-quality products and systems is available, permitting almost unlimited applications.

## The advantages at a glance:

- **Standardised GL-thread and matching cap systems**  
for particularly tight sealing and simple, clean pouring out
- **Outstanding chemical resistance and near inert behaviour**  
no interfering ion exchange
- **High temperature and thermal shock resistance**  
ideal for autoclaving and dry sterilising
- **Sturdy design and uniform wall thickness distribution**  
for improved safety and longer service life
- **Transparent**  
contents and volume can be quickly checked
- **Glass Type 1 (neutral glass) conforming to USP/EP**  
especially suited to applications in the pharmaceutical and food industries
- **Very stable**  
due to large base
- **Easy labelling**  
thanks to large labelling field
- **Practicality**  
easy to read, permanent graduations
- **Retrace Code**  
using the eight-character Retrace Code and the corresponding article number, the batch and quality certificate for every DURAN® laboratory glass bottle can be obtained at [www.DWK-LifeSciences.com](http://www.DWK-LifeSciences.com)

01



> Find your nearest **distributor** on our global network:  
[www.DWK-LifeSciences.com/DURAN/distributors](http://www.DWK-LifeSciences.com/DURAN/distributors)

With easy-to-read scale and large labelling field for easy marking, in fired-on, highly durable white ceramic. With proven DURAN® properties. Complete with blue screw cap (PP, integral lip seal) and pouring ring (PP) for drip-free pouring and clean, safe working. Service temperature level of screw cap and pouring ring: +140 °C.

Typical applications: storage, sample preparation, transport. Autoclaving media.

Cat. No.	Capacity (mL)	DIN Thread (GL)	d (OD) (mm)	h (mm)	Remark	Pack Unit
with screw cap and pouring ring from PP (blue)						
21 801 08 51	10	25	36	54	Acceptance within ISO 4796 standard has been requested. With specially shaped glass edge for improved pouring out (so that an additional plastic pouring ring is not required).	10
21 801 14 53	25	25	36	74	With specially shaped glass edge for improved pouring out (so that an additional plastic pouring ring is not required).	10
21 801 17 53	50	32	46	91		10
21 801 24 58	100	45	56	105		10
21 801 29 55	150	45	62	115		10
21 801 36 51	250	45	70	143		10
21 801 44 59	500	45	86	181		10
21 801 51 55	750	45	95	208		10
21 801 54 55	1 000	45	101	230		10
21 801 63 57	2 000	45	136	265		10
21 801 69 57	3 500	45	160	300		1
21 801 73 53	5 000	45	182	335		1
21 801 86 58	10 000	45	227	415		1
21 801 88 55	15 000	45	268	450		1
21 801 91 57	20 000	45	288	510		1
21 801 92 51	25 000	45	316	545		1
without screw cap and pouring ring						
21 801 08 02	10	25	36	50	Acceptance within ISO 4796 standard has been requested. With specially shaped glass edge for improved pouring out (so that an additional plastic pouring ring is not required).	10
21 801 14 04	25	25	36	70	With specially shaped glass edge for improved pouring out (so that an additional plastic pouring ring is not required).	10
21 801 17 04	50	32	46	87		10
21 801 24 09	100	45	56	100		10
21 801 29 06	150	45	62	110		10
21 801 36 02	250	45	70	138		10
21 801 44 01	500	45	86	176		10
21 801 51 06	750	45	95	203		10
21 801 54 06	1 000	45	101	225		10
21 801 63 08	2 000	45	136	260		10
21 801 69 08	3 500	45	160	295		1
21 801 73 04	5 000	45	182	330		1
21 801 86 09	10 000	45	227	410		1
21 801 88 06	15 000	45	268	445		1
21 801 91 08	20 000	45	288	505		1

## DURAN® Original Laboratory Bottle

with DIN thread

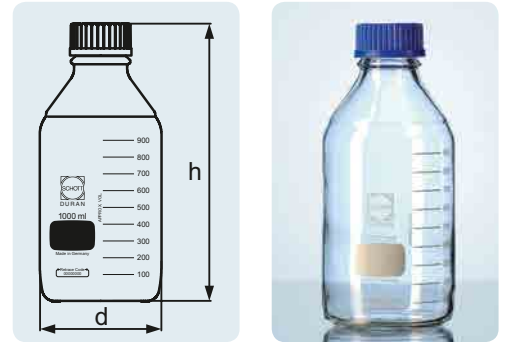

## 01 LABORATORY GLASS BOTTLES AND ACCESSORIES

### DURAN® Original GL 45 Laboratory Bottles complete with High Temperature Closures

with DIN Thread, clear, graduated



DURAN® original GL 45 Laboratory Bottles are available complete with high temperature screw caps and pouring rings. The PBT cap and ETFE pouring rings offer greater thermal and chemical resistance than the equivalent polypropylene components.

Typical applications: Dry heat sterilization, autoclaving of liquid media, storage of corrosive reagents and sampling.

Cat. No.	Capacity (mL)	DIN Thread (GL)	d (OD) (mm)	h (mm)	Pack Unit
With high temperature screw cap and ETFE pouring ring					
21 801 24 17	100	45	56	105	10
21 801 36 19	250	45	70	143	10
21 801 44 18	500	45	86	181	10
21 801 54 14	1 000	45	101	230	10
21 801 63 16	2 000	45	136	265	10
21 801 73 12	5 000	45	182	335	1
21 801 86 17	10 000	45	227	415	1

With easy-to-read scale and large labelling field for easy marking, in fired-on, highly durable white ceramic. UV protection up to approx. 500 nm wavelength. Unchanged DURAN® properties within the bottle, as colouration is only on the outer surface. Very uniform, durable and chemically resistant amber colour due to use of innovative technology.

Typical applications: storage and transport of light-sensitive substances.

Cat. No.	Capacity (mL)	DIN Thread (GL)	d (OD) (mm)	h (mm)	Remark	Pack Unit
with screw cap and pouring ring from PP (blue)						
21 806 08 56	10	25	36	54	Acceptance within ISO 4 796 standard has been requested. With specially shaped glass edge for improved pouring out (so that an additional plastic pouring ring is not required).	10
21 806 14 58	25	25	36	74	With specially shaped glass edge for improved pouring out (so that an additional plastic pouring ring is not required).	10
21 806 17 58	50	32	46	91		10
21 806 24 54	100	45	56	105		10
21 806 29 51	150	45	62	115		10
21 806 36 56	250	45	70	143		10
21 806 44 55	500	45	86	181		10
21 806 51 51	750	45	95	208		10
21 806 54 51	1 000	45	101	230		10
21 806 63 53	2 000	45	136	265		10
21 806 69 53	3 500	45	160	300		1
21 806 73 58	5 000	45	182	335		1
21 806 86 54	10 000	45	227	415		1
without screw cap and pouring ring						
21 806 08 07	10	25	36	50	Acceptance within ISO 4 796 standard has been requested. With specially shaped glass edge for improved pouring out (so that an additional plastic pouring ring is not required).	10
21 806 14 09	25	25	36	70	With specially shaped glass edge for improved pouring out (so that an additional plastic pouring ring is not required).	10
21 806 17 09	50	32	46	87		10
21 806 24 05	100	45	56	100		10
21 806 29 02	150	45	62	110		10
21 806 36 07	250	45	70	138		10
21 806 44 06	500	45	86	176		10
21 806 51 02	750	45	95	203		10
21 806 54 02	1 000	45	101	225		10
21 806 63 04	2 000	45	136	260		10
21 806 69 04	3 500	45	160	295		1
21 806 73 09	5 000	45	182	330		1
21 806 86 05	10 000	45	227	410		1
21 806 88 02	15 000	45	268	445		1
21 806 91 04	20 000	45	288	505		1

## DURAN® Laboratory Bottle Amber

with DIN thread, USP <660> and USP <671> (Spectral Transmission) compliant

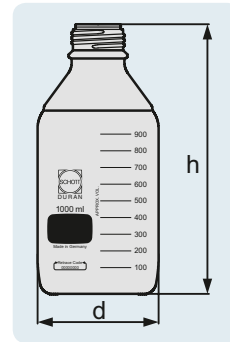

## DURAN® Protect Laboratory Bottle

with DIN thread, plastic coated



With easy-to-read scale. In fired-on, highly durable white ceramic. Service temperature limit of the PU plastic coating: -30 °C to +135 °C. The coating provides scratch, leak\* and splinter\* protection and is ideally suited to both the transport and storage of hazardous media or valuable samples. UV protection up to approx. 380 nm wavelength. High transparency. Suitable for microwaving. (\* only applies to bottles 5 000 mL and less)

Typical applications: storage, transport and safe handling of hazardous or valuable substances.

Cat. No.	Capacity (mL)	DIN Thread (GL)	d (OD) (mm)	h (mm)	Remark	Pack Unit
<b>with screw cap and pouring ring</b>						
21 805 24 53	100	45	56	100		10
21 805 29 59	150	45	62	110		10
21 805 36 55	250	45	70	138		10
21 805 44 54	500	45	86	176		10
21 805 51 59	750	45	95	203		10
21 805 54 59	1 000	45	101	225		10
21 805 63 52	2 000	45	136	260		10
21 805 69 52	3 500	45	160	295		1
21 805 73 57	5 000	45	182	330		1
<b>without screw cap and pouring ring</b>						
21 805 08 06	10	25	36	50	Acceptance within ISO 4 796 standard has been requested. With specially shaped glass edge for improved pouring out (so that an additional plastic pouring ring is not required).	10
10 926 76	25	25	36	70	With specially shaped glass edge for improved pouring out (so that an additional plastic pouring ring is not required).	10
10 926 77	50	32	46	87		10
21 805 24 04	100	45	56	100		10
21 805 29 01	150	45	62	110		10
21 805 36 06	250	45	70	138		10
21 805 44 05	500	45	86	176		10
21 805 51 01	750	45	95	203		10
21 805 54 01	1 000	45	101	225		10
21 805 63 03	2 000	45	136	260		10
21 805 69 03	3 500	45	160	295		1
21 805 73 08	5 000	45	182	330		1
21 805 86 04	10 000	45	228	410		1
21 805 88 01	15 000	45	268	445		1
21 805 91 03	20 000	45	289	505		1

With easy-to-read scale. In fired-on, highly durable white ceramic. Service temperature limit of the PU plastic coating: -30 °C to +135 °C. The coating provides scratch, leak and splinter protection and is ideally suited to both the transport and storage of hazardous media or valuable samples. UV protection up to approx. 500 nm wavelength. Unchanged DURAN® properties within the bottle, as colouration is only on the outer surface. Very uniform, durable and chemically resistant amber colour due to use of innovative technology. Suitable for microwaving.

Typical applications: storage, transport and safe handling of hazardous or valuable substances.

Cat. No.	Capacity (mL)	DIN Thread (GL)	d (OD) (mm)	h (mm)	Remark	Pack Unit
without screw cap and pouring ring						
21 806 14 33	25	25	36	70	With specially shaped glass edge for improved pouring out (so that an additional plastic pouring ring is not required).	10
21 806 17 33	50	32	46	87		10
21 806 24 38	100	45	56	110		10
21 806 36 31	250	45	70	138		10
21 806 44 39	500	45	86	176		10
21 806 54 35	1000	45	101	225		10
21 806 63 37	2000	45	136	260		10
21 806 73 33	5000	45	182	330		1
11 735 48	10000	45	227	410		1

With easy-to-read scale and large labelling field for easy marking, in fired-on, highly durable ceramic. Pressure resistance conforms to DIN EN 1595, confirmed by GS marking (TÜV ID: 0000020716). Vacuum and/or pressure resistant from -1 bar to +1.5 bar due to modified geometry (based on ISO 4796-1). When pressure loaded the following apply: thermal shock resistance 30 K and maximum usage temperature +140 °C. Blue scale for visual differentiation from the standard laboratory bottle. Also available in amber.

Typical applications: safe working under pressure or vacuum, sampling under pressure, storage of gas generating media.

Cat. No.	Capacity (mL)	DIN Thread (GL)	d (OD) (mm)	h (mm)	Pack Unit
without screw cap and pouring ring					
21 810 24 06	100	45	56	100	10
10 922 34	250	45	70	138	10
10 922 35	500	45	86	176	10
21 810 54 03	1000	45	101	225	10

### DURAN® Protect Laboratory Bottle Amber

with DIN thread, plastic coated, USP <660> and USP <671> (Spectral Transmission) compliant

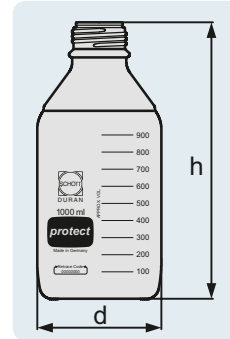

### DURAN® pressure plus+ Laboratory Bottle

with DIN thread, GL 45

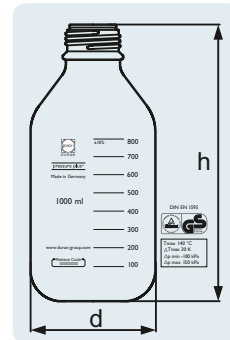

### DURAN® pressure plus+ Laboratory Bottle Amber

with DIN thread, GL 45, USP <660> and USP <671> (Spectral Transmission) compliant

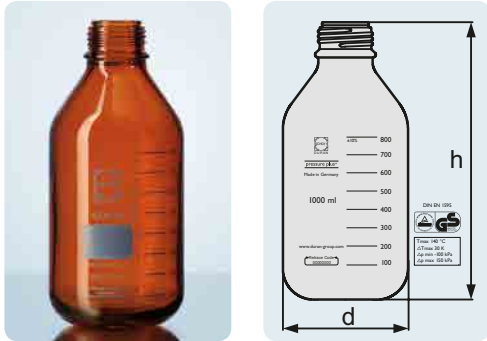

With easy-to-read scale and large labelling field for easy marking, in fired-on, highly durable ceramic. Pressure resistance conforms to DIN EN 1595, confirmed by GS marking (TÜV ID: 0000020716). Vacuum and/or pressure resistant from –1 bar to +1.5 bar due to modified geometry (based on ISO 4796-1). When pressure loaded the following apply: thermal shock resistance 30 K and maximum usage temperature +140 °C. Blue scale for visual differentiation from the standard laboratory bottle. UV protection up to approx. 500 nm wavelength. Unchanged DURAN® properties within the bottle, as colouration is only on the outer surface. Very uniform, durable and chemically resistant amber colour due to use of innovative technology.

Typical applications: safe working under pressure or vacuum, sampling under pressure, storage of gas generating media.

Cat. No.	Capacity (mL)	DIN Thread (GL)	d (OD) (mm)	h (mm)	Pack Unit
without screw cap and pouring ring					
21 816 24 03	100	45	56	100	10
10 943 67	250	45	70	138	10
10 943 68	500	45	86	176	10
21 816 54 09	1000	45	101	225	10

### DURAN® pressure plus+ Laboratory Bottle Protect

plastic coated, with DIN thread, GL 45

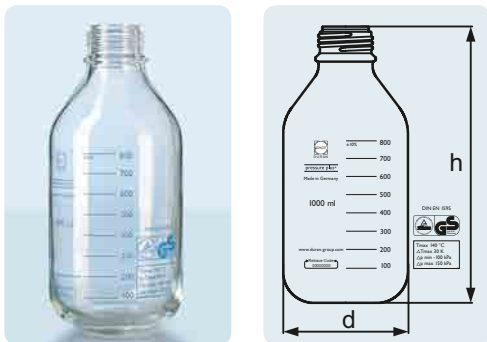

With easy-to-read scale and large labelling field for easy marking, in fired-on, highly durable ceramic. Pressure resistance conforms to DIN EN 1595, confirmed by GS marking (TÜV ID: 0000020716). Vacuum and/or pressure resistant from –1 bar to +1.5 bar due to modified geometry (based on ISO 4796-1). When pressure loaded the following apply: thermal shock resistance 30 K and maximum usage temperature +140 °C. Blue scale for visual differentiation from the standard laboratory bottle. The coating provides scratch, leak and splinter protection and is ideally suited to both the transport and storage of hazardous media or valuable samples.

Typical applications: safe working under pressure or vacuum, sampling under pressure, storage of gas generating media.

Cat. No.	Capacity (mL)	DIN Thread (GL)	d (OD) (mm)	h (mm)	Pack Unit
without screw cap and pouring ring					
21 815 24 02	100	45	56	100	10
11 759 25	250	45	70	138	10
11 759 26	500	45	86	176	10
21 815 54 08	1000	45	101	225	10



With easy-to-read scale and large labelling field for easy marking, in fired-on, highly durable ceramic. Complete system comprising: DURAN® pressure plus+ laboratory bottle with 4-port screw cap (PP); four screw connections (black, M8 thread) and silicone seals. Connection of different hose diameters (1.6 mm and 3.2 mm) as well as sterile pressure equalisation sets (syringe filter 0.2 µm) is possible. Unused ports can be sealed with silicone blanking seals.

Typical applications: safe transfer of liquid media within a closed and sterile system (evaporation is reduced).

Cat. No.	Description	Capacity (mL)	DIN Thread (GL)	d (OD) (mm)	h (mm)	Pack Unit
11 298 21	HPLC Bottle complete	500	45	86	176	2
11 298 20	HPLC Bottle complete	1 000	45	101	225	2
<b>Accessories</b>						
11 298 12	Screw cap HPLC, GL 45, 4 ports, complete (GL 45 screw cap, 4 x M8 black screw caps, 12 x silicone seals for 1.6, 3.2 mm tubing or blanks)					2
11 298 13	Replacement parts for HPLC screw cap includes M8 caps and 1.6, 3.2 mm and blind silicone seals					1
11 378 01	Pressure compensation set 4-port cap (incl. 0.2 µm syringe filter)					1
11 298 19	Spare syringe filter for pressure compensation, 0.2 µm					2

### DURAN® HPLC Bottle

with DIN thread, GL 45

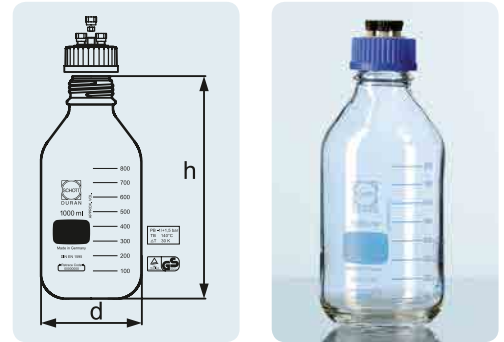

With easy-to-read scale and large labelling field for easy marking, in fired-on, highly durable white ceramic. Complete with blue screw cap (PP, integral lip seal) and pouring ring (PP) for drip-free pouring and clean, safe working. Service temperature limit of screw cap and pouring ring: +140 °C. Ergonomic handling due to angular shape, highly stable, good stackability. Alongside proven DURAN® properties, a space saving of 44% in comparison with standard laboratory bottles (example applies to 100 mL bottles). Screw caps are also available in the following colours: green, yellow and grey.

Typical applications: space-saving storage, space-saving transport.

Cat. No.	Capacity (mL)	DIN Thread (GL)	d (OD) (mm)	h (mm)	Pack Unit
<b>with screw cap and pouring ring from PP (blue)</b>					
21 820 24 53	100	32	50	109	10
21 820 36 55	250	45	64	143	10
21 820 44 54	500	45	78	181	10
21 820 54 59	1 000	45	94	222	10
<b>without screw cap and pouring ring</b>					
21 820 24 04	100	32	50	109	10
10 088 34	250	45	64	143	10
10 088 42	500	45	78	181	10
10 088 43	1 000	45	94	222	10

### DURAN® Laboratory Bottle, Square

with DIN thread

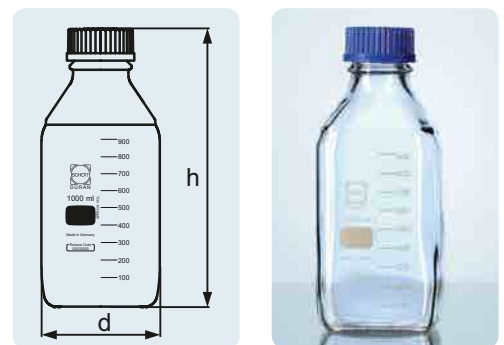

## DURAN® Premium Bottle

with DIN thread, GL 45

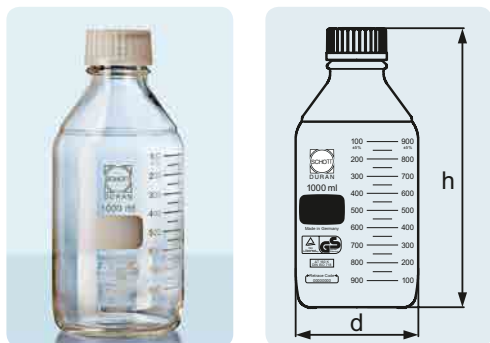

With easy-to-read scale and large labelling field for easy marking, in fired-on, highly durable white ceramic. Complete with pouring ring and cap from TpCh260 (similar to PFA ). The premium cap with its PTFE coated silicone seal is colourless and temperature resistant from  $-196\text{ }^{\circ}\text{C}$  to  $+200\text{ }^{\circ}\text{C}$ . Together with proven DURAN® properties, TÜV tested thermal shock resistance of 160 K, confirmed by GS-marking (TÜV ID: 0000020715). USP/FDA conformity for the entire system comprised of bottle, screw cap and pouring ring. Accurate scale:  $\pm 5\%$ . Additional graduations as well as additional opposing scale simplify reading off.

Typical applications: Due to its properties, ideal for applications in the pharmaceutical industry, handling of aggressive media, sterilisation processes (hot air and dry sterilisation) and depyrogenation.

Cat. No.	Capacity (mL)	DIN Thread (GL)	d (OD) (mm)	h (mm)	Pack Unit
with premium screw cap and pouring ring					
11 270 75	100	45	56	105	10
11 270 76	250	45	70	143	10
11 270 77	500	45	86	181	10
11 270 78	1000	45	101	230	10

## Stainless Steel Laboratory Bottle

with DIN thread, GL 45



The unbreakable steel bottle is ideal for storage applications where glass is not applicable, due to the risk of breakage or chemical incompatibility. Manufactured from corrosion resistant AISI Type 316L (1.4404) stainless steel, and hygienically constructed with all welded seams. The bottle has a smooth inner surface finish that corresponds to IIIc (DIN 17441) with rounded inner edges for ease of cleaning. Polished and brushed durable exterior finish. The bottle has a GL 45 thread with a built-in pouring lip. Supplied without a cap, stainless steel cap is available. It is fully compatible with all the GL 45 caps.

Typical applications: Hazardous materials laboratory container for storage of liquids, intermediates, or solid product. Storage of precious materials, such as high purity fine chemicals, pharmaceutical or cosmetic products. Storage of light sensitive materials.

Cat. No.	Description	Capacity (mL)	DIN Thread (GL)	d (OD) (mm)	h (mm)	Pack Unit
29 901 60 06	GL 45 Stainless Steel Laboratory Bottle	1500	45	122.5	207	1
29 911 28 08	Stainless Steel cap, with PTFE sealing-disc GL 45		45	50	27	1

The unbreakable steel bottle is ideal for the storage and safe shipping of dangerous liquid goods such as solvents, and reagents, without the need for additional protective outer packaging. Manufactured from corrosion resistant AISI Type 316L (1.4404) stainless steel, and hygienically constructed with all welded seams. The bottle has a smooth inner surface finish that corresponds to IIIc (DIN 17441) with rounded inner edges for ease of cleaning. Polished and brushed durable exterior finish. The bottle has a GL 45 thread with a built-in pouring lip. Supplied complete with GL 45 Stainless Steel screw cap and PTFE surfaced Platinum-catalyzed silicon cap liner, and UN certification number. Certified to UN standards for the carriage of liquids classified as dangerous goods in UN packing Groups II (medium danger) and III (low danger). It is suitable for liquids with a relative density of 2.0 or less. International regulations are subject to change, it is the user's responsibility for complying with all applicable laws and regulations.

Typical applications: Container for the shipping of hazardous or non-hazardous liquids. Storage or shipping of precious liquids, such as high purity fine chemicals, pharmaceutical or cosmetic products. Storage of light sensitive liquids.

Cat. No.	Description	Capacity (mL)	DIN Thread (GL)	d (OD) (mm)	h (mm)	Pack Unit
29 901 60 55	Stainless Steel Shipping Bottle, UN-certified, complete	1 500	45	120	201	1

## Stainless Steel Shipping Bottle UN certified

from stainless steel type 316 L (1.4404)



These larger sized bottles / carboys are ideal for bulk storage and handling of both liquid and solid intermediates and final formulations. Manufactured from Type 1 borosilicate 3.3 glass for durable performance and resistance to thermal stress. The glass conforms to American (USP), European (EP) and Japanese pharmacopoeia (JP) standards making the carboys ideal for pharmaceutical production applications. Manufactured with thickened, uniform side walls for higher mechanical strength. Retrace Code for batch traceability and conformance certification. Manufactured from inorganic materials (Certified BSE / TSE free). Suitable for high temperature sterilization, depyrogenisation or autoclaving. Feature large, permanent, easy-to-read, white enamel graduations marks. Also available with an external Polyurethane coating for enhanced scratch resistance, and to contain leakage in the event of damage. Available with customized logos, identification labeling or graduations. Supplied without screw cap or pouring ring, but can be used in conjunction caps and connector systems.

Typical applications: Flat robust base is ideal for mixing processes with large magnetic stir bars.

Cat. No.	Capacity (mL)	DIN Thread (GL)	d (OD) (mm)	h (mm)	Pack Unit
without screw-cap and pouring ring					
11 601 00	20 000	45	289	505	1
11 602 00	10 000	45	228	410	1

## DURAN® Production and Storage Bottle Carboys

with DIN thread, GL 45

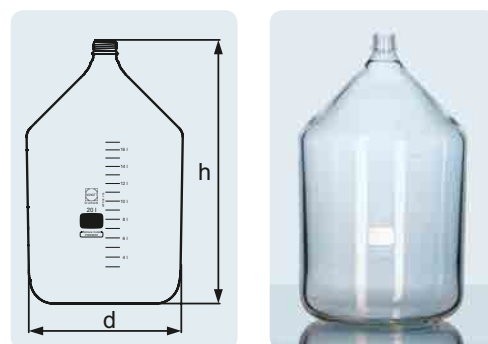

## DURAN® YOUTILITY Laboratory Bottle

GL 45

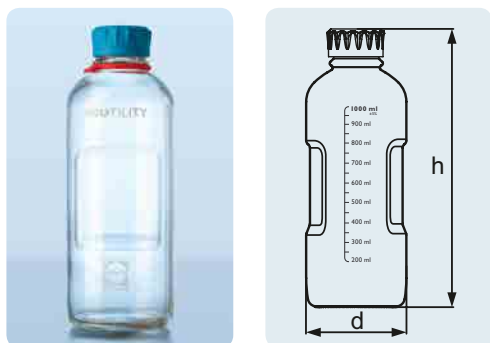

The specially shaped gripping zones on both sides of the bottle enable easier and safer handling. With the new DURAN® YOUTILITY bottle thread opening or closing the bottle is significantly faster. The thread is fully compatible with DIN GL 45 closures and other accessories. The slimmer DURAN® YOUTILITY bottle shape allows a more optimal use of limited space in autoclaves and laboratory refrigerators. A pre-defined labelling area is compatible with the dedicated DURAN® self-adhesive YOUTILITY bottle labels. Nominal volume is shown at the top of the easy-to-read graduation scale for fast determination of the volumes. Each DURAN® YOUTILITY bottle is supplied as a complete system, with a pouring ring (PP) and a GL 45 cap (PP).

Cat. No.	Capacity (mL)	DIN Thread (GL)	d (OD) (mm)	h (mm)	Pack Unit
with screw-cap and pouring ring from PP					
21 881 28 54	125	45	55	124	4
21 881 36 53	250	45	66	158	4
21 881 44 52	500	45	78	193	4
21 881 54 57	1000	45	93	253	4



## DURAN® YOUTILITY Laboratory Bottle Amber

GL 45, USP <660> and USP <671> (Spectral Transmission) compliant

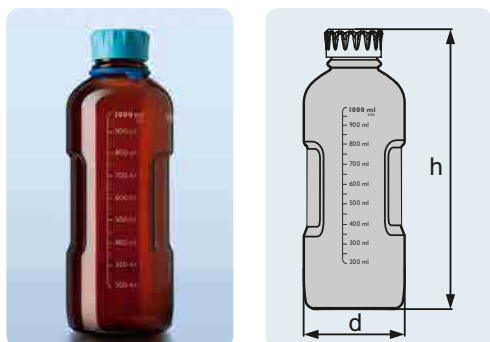

The specially shaped gripping zones on both sides of the bottle enable easier and safer handling. With the new DURAN® YOUTILITY bottle thread opening or closing the bottle is significantly faster. The thread is fully compatible with DIN GL 45 closures and other accessories. The slimmer DURAN® YOUTILITY bottle shape allows a more optimal use of limited space in autoclaves and laboratory refrigerators. A pre-defined labelling area is compatible with the dedicated DURAN® self-adhesive YOUTILITY bottle labels. Nominal volume is shown at the top of the easy-to-read graduation scale for fast determination of the volumes. The glass bottle body is moulded from the tried and tested DURAN® borosilicate 3.3 pharmacopoeial Type 1 neutral glass. DURAN® glass offers very good chemical resistance and high temperature resistance. Each DURAN® YOUTILITY bottle is supplied as a complete system, with a pouring ring (PP) and a GL 45 cap (PP).

Cat. No.	Capacity (mL)	DIN Thread (GL)	d (OD) (mm)	h (mm)	Pack Unit
with screw-cap and pouring ring from PP					
21 886 28 59	125	45	55	124	4
21 886 36 58	250	45	66	158	4
21 886 44 57	500	45	78	193	4
21 886 54 53	1000	45	93	253	4



## DURAN® YOUTILITY Screw Cap from PP

GL 45

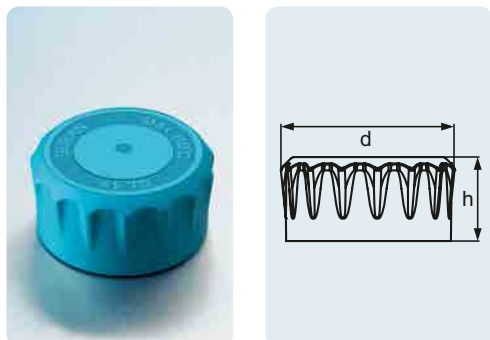

The DURAN® YOUTILITY Screw Cap GL 45 is manufactured from a food-grade polypropylene (PP). Ergonomically shaped screw cap with optimised grooves and ridges for a more efficient and easier tightening or removal. The faster opening and closing thread of the YOUTILITY screw cap is fully compatible with DIN GL 45 bottle threads. The optimised cap sealing system ensures a liquid tight seal. A pre-defined labelling area on the cap is compatible with the dedicated DURAN® self-adhesive YOUTILITY labels.

Cat. No.	DIN Thread (GL)	d (OD) (mm)	h (mm)	Colour	Pack Unit
screw cap					
29 229 28 02	45	53	25	cyan	10
pouring ring					
29 241 28 08	45		4	cyan	16



# DURAN® YOUTILITY

## DESIGNED FOR YOU



[www.duran-yutility.com](http://www.duran-yutility.com)



**DURAN  
WHEATON  
KIMBLE**

Excellence in your hands

## DURAN® YOUTILITY Bottle Tag

GL 45, from silicone

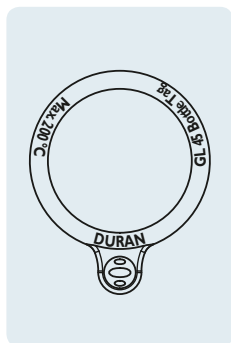

The silicone GL 45 Bottle Tags can be securely attached around the neck of the YOUTILITY bottle for easy customisation and unambiguous bottle identification. The elastic Bottle Tags will fit around any DIN GL 45 bottle neck.

Cat. No.	Thread	Colour	Pack Unit
29 243 29 04	45	eight colours, two pieces each	16
29 243 28 18	45	red	20
29 243 28 26	45	orange	20
29 243 28 34	45	yellow	20
29 243 28 42	45	green	20
29 243 28 59	45	blue	20
29 243 28 67	45	purple	20
29 243 28 75	45	black	20
29 243 28 83	45	white	20



## DURAN® YOUTILITY LABELS

Printable self-adhesive

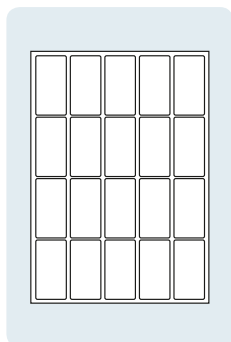

The robust DURAN® YOUTILITY identification labels are suitable for use with the YOUTILITY bottle, plus many other types of laboratory glassware, such as GL 45 bottles, beakers and conical flasks. The tear resistant, white polyester labels use a high performance, peelable adhesive. An easy-to-use label creator web app. is available ([www.duranlabels.com](http://www.duranlabels.com)) to design, and print your own label designs. Ideal for use in fridges, freezers, autoclaves, incubators, and water baths, without the risk of the labels falling off. Can be printed with office printers, copiers, or marked with technical lab pens. Chemically resistant to many typical laboratory chemicals, and solvents. Wide -40 to +150 °C thermal performance range.

Cat. No.	Description	Pack Unit
29 401 02 03	white, polyester	1 x 100 labels

## DURAN® Original GL Screw Cap from PP

with lip seal

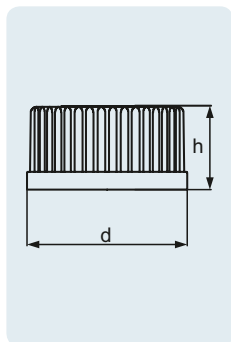

Available in the colours blue, green, yellow and grey with matching colour pouring rings. Distinguishing media types is simplified and interchanging of screw caps and carry over of substances is practically eliminated.

Typical applications: visual aid to the safe identification of different media.

Cat. No.	DIN Thread (GL)	d (OD) (mm)	h (mm)	Colour	Pack Unit
<b>screw cap</b>					
29 239 13 07	25	33	19	blue	10
29 239 19 07	32	40	24	blue	10
29 239 28 09	45	54	25	blue	10
29 338 28 02	45	54	25	yellow	10
29 338 28 68	45	54	25	green	10
29 338 28 84	45	54	25	grey	10
<b>Pouring ring</b>					
29 242 19 07	32		4	blue	10
29 242 28 09	45		4	blue	10
10 899 11	45		4	green	10
10 899 14	45		4	grey	10
10 899 17	45		4	yellow	10



For all GL 45, GL 32 and GL 25 threads. Ideal for autoclaving processes because the 0.2 micron ePTFE membrane permits pressure equalisation and tight sealing, greatly reducing the risk of contamination. Ingress of liquids or solids is prevented and the bottle contents remain sterile.

Typical applications: storage or transport of gas generating media, autoclaving of media.

Cat. No.	DIN Thread (GL)	d (OD) (mm)	h (mm)	Pack Unit
29 118 13 07	25	33	19	5
29 118 19 07	32	41	24	5
29 118 28 09	45	54	25	5

### DURAN® GL Membrane Vented Screw Cap

from PP, blue, with welded-in PTFE, membrane for pressure equalisation

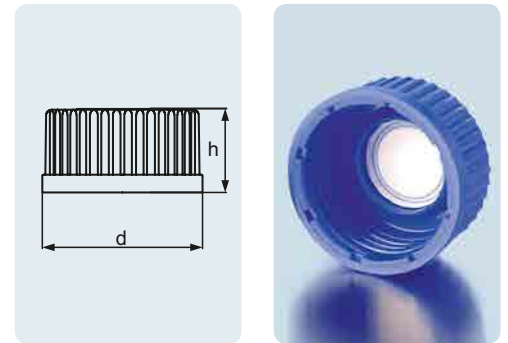

A  
121 °C

Tmax.  
140 °C

High leak tightness through use of PTFE coated silicone seal (peroxide-cured silicone). More chemically and heat resistant than PP screw cap. A matching ETFE pouring ring is also available, permitting clean, drip-free use.

Cat. No.	DIN Thread (GL)	d (OD) (mm)	h (mm)	Pack Unit
screw cap				
29 240 08 06	14	20	17	10
29 240 11 08	18	23	20	10
29 240 13 05	25	33	23	10
29 240 19 05	32	41	26	10
29 240 28 07	45	54	28	10
Pouring ring				
29 244 19 09	32		4	10
29 244 28 02	45		4	10

### DURAN® Red GL High Temperature Screw Cap from PBT

with PTFE coated silicone seal

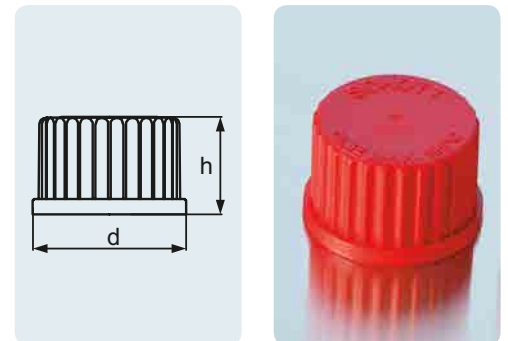

A  
121 °C

Tmax.  
180 °C

Suitable for PBT screw caps and tamper-evident screw caps. Heat resistance: 130 °C (vapour) and 200 °C (dry heat). Good chemical resistance due to PTFE coating. Silicon is peroxidically cured.

Cat. No.	For screw-caps, red (GL)	Pack Unit
29 248 08 05	14	10
29 248 11 07	18	10
29 248 13 04	25	10
29 248 19 04	32	10
29 248 28 06	45	10

### DURAN® Replacement Cap Liner

PTFE coated silicone, VMQ

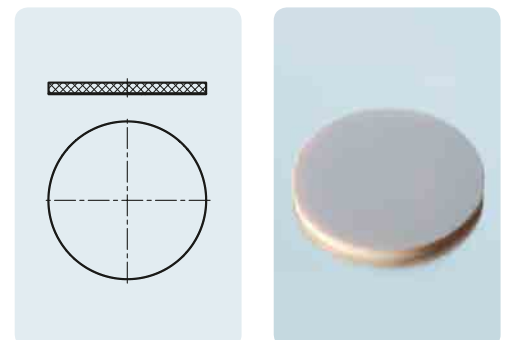

A  
121 °C

Tmax.  
200 °C



## DURAN® Screw Cap with aperture

from PBT, red

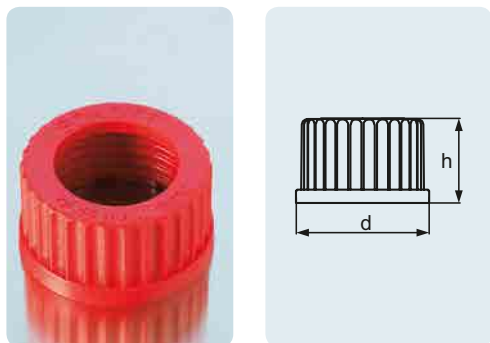

A  
121 °C

Tmax.  
180 °C

Suitable for silicone seal for piercing (Septa). More chemically resistant than PP cap.

Typical applications: Injection or removal of media.

Cat. No.	DIN Thread (GL)	Aperture bore d (OD) (mm)	d (OD) (mm)	h (mm)	Pack Unit
29 227 05 08	14	9.5	20	17	10
29 227 06 02	18	11	23	20	10
29 227 09 02	25	15	33	23	10
29 227 08 08	32	20	42	26	10
29 227 10 07	45	34	54	28	10

## DURAN® Silicone Septum Seal

for piercing, VMQ

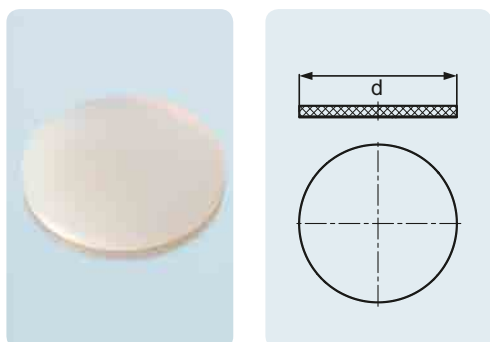

A  
121 °C

Tmax.  
200 °C

Suitable for PBT screw cap with aperture Heat resistance: 130 °C (vapour) and 200 °C (dry heat). Silicon is peroxide catalysed.

Typical applications: injection or removal of media.

Cat. No.	DIN Thread (GL)	d (OD) (mm)	Thickness (mm)	Pack Unit
29 246 05 03	14	12	2	100
29 246 06 06	18	16	2	100
29 246 09 06	25	22	2	100
29 246 08 03	32	29	2	100
29 246 10 02	45	42	3	100

## DURAN® PTFE coated GL 45 Silicone Septum for piercing

Platinum catalysed VMQ

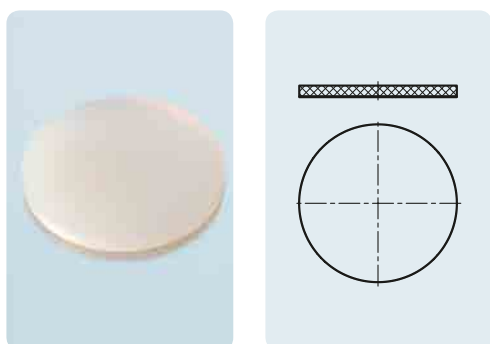

High purity PTFE coated silicone septum for use with DURAN® GL 45 open topped screw cap and all sizes of DURAN® GL 45 laboratory bottles. Can be used for the addition, inoculation or sampling using a syringe and needle. Ideal for chemistry, life science and biopharma laboratories.

Cat. No.	Thread	d (OD) (mm)	Thickness (mm)	Pack Unit
29 248 30 05	GL 45	43	3	10



DURAN® bromobutyl rubber closure provide a gas tight seal for all GL 45 laboratory bottles. Bromobutyl rubber is essentially impermeable to most gasses, and provides a controlled environment inside the glass bottle for oxygen sensitive materials. Useful for maintaining anaerobic culture conditions. Butyl rubber allows for multiple punctures providing easy access to the contents with a syringe.

### DURAN® GL 45 Bromobutyl Rubber Stopper

straight plug, Grey Bromobutyl, for GL 45 laboratory bottles

Cat. No.	DIN Thread (GL)	d (OD) (mm)	h (mm)	Pack Unit
29 206 28 03	GL 45	41	21	10

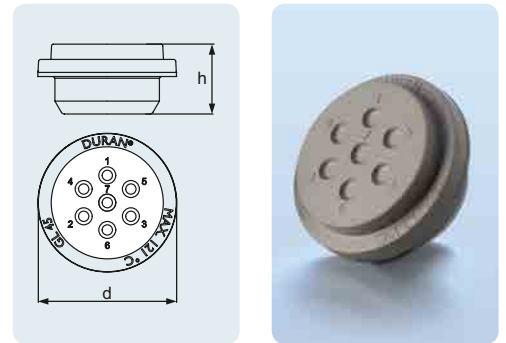

Cap is moulded from a pigment free polymer to reduce the risk of leaching. Wide usable temperature range from –196 °C to +200 °C. Very high chemical resistance. Complete with colourless PTFE faced silicone cap liners for high leak tightness. The matching PFA pouring ring permits drip-free pouring is available separately. Replacement PTFE faced silicone cap liners are available (platinum-cured silicone).

### DURAN® Premium Cap

PFA, with PTFE faced silicone cap liner

Typical applications: Due to its exceptional properties, it is ideal for applications in the pharmaceutical industry, storage of aggressive materials, and demanding sterilisation processes such as hot air sterilisation or depyrogenation.

Cat. No.	DIN Thread (GL)	d (OD) (mm)	h (mm)	Colour	Pack Unit
<b>Screw cap</b>					
10 886 79	45	51	26	colourless	5
11 296 00	25	32	22	colourless	5
<b>Pouring ring</b>					
10 886 78	45		4	colourless	5
<b>Replacement cap liners</b>					
29 248 14 07	25	23.5	3.1		10
29 248 29 09	45	43.1	3.1		10

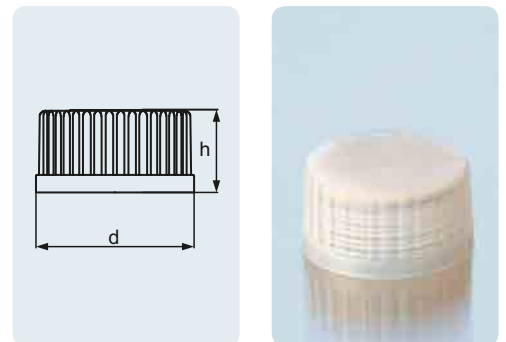

## DURAN® Tamper Evident Screw Caps

from PP, for laboratory bottles, with DIN thread

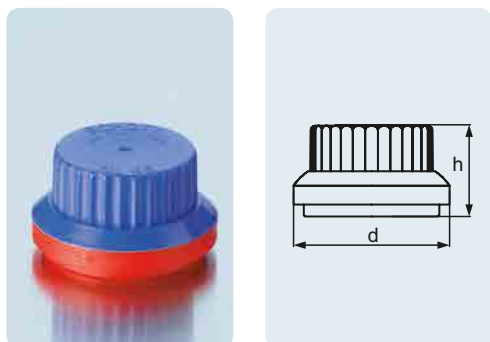

A  
121 °C

Tmax.  
140 °C

The tamper-evident screw caps are available with either a plug seal or a PTFE faced silicone cap liner (peroxide cured silicone). The integral coloured plastic ring tears when the cap is first opened, and is retained on the bottle neck. Therefore it can be clearly seen if the bottle has been opened after being first sealed. After the initial removal, both caps will still function as “normal” screw cap.

Typical applications: secure storage and transport / shipping of valuable media.

Cat. No.	DIN Thread (GL)	d (OD) (mm)	h (mm)	Colour	Pack Unit
Plug sealing					
10 175 26	45	66	38	blue-red	10
PTFE faced silicone cap liner					
11 558 86	45	66	38	blue-yellow	10

## DURAN® Stainless Steel Multiport Connector GL 45

from PBT, GL 45, with 2 or 3 ports

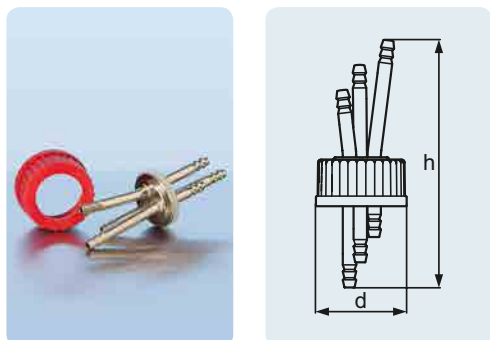

A  
121 °C

Tmax.  
180 °C

Retrace Code

A robust and durable tubing connection system for use with all sizes of DURAN® GL 45 laboratory and media bottles. The bottle top adaptor facilitates the transfer of liquids within a closed and sterile system. The barbed hose connectors are suitable for flexible tubing with an 8.0mm inner diameter. Freely rotating stainless steel centre allows the bottle to be unscrewed without the need to disconnect the tubing. Connectors and body are manufactured from Type 316L (1.4404 / S31603) stainless steel. A silicone gasket and the red PBT GL 45 screw cap provide a liquid tight seal. Wide temperature usage range (up to 180 °C). Autoclavable (121 °C for 15 minutes). Retrace coded for full traceability. Ideal for chemistry, life science and biopharma laboratories.

Cat. No.	Description	DIN Thread (GL)	d (OD) (mm)	h (mm)	Pack Unit
29 261 27 01	2-port connector	45	54	137	1
29 261 28 04	3-port connector	45	54	145	1
Replacement silicone gasket					
29 223 28 05	silicone gasket with aperture (diameter 27.5 mm)		40.5	3	10

GL 45 cap connection system for the easy connection of flexible tubing to the DURAN® GL 45 bottles. The two polypropylene connectors have angled top and straight underside connectors. Grey polypropylene cap center rotates freely, allowing the bottle to be unscrewed without the need to disconnect the tubing. The cap is ideal for use with soft elastic tubing that has an inner diameter of 6 – 9 mm silicone tubing. An optional venting connector is available with, or without a syringe filter. Highly versatile as the screw cap is based on the standard GL 45 thread. Temperature resistant up to + 140 °C. Fully autoclavable and washer-proof.

Typical applications: Possible biotech applications include the transfer of sterile media from one container to another using a peristaltic pump.

Cat. No.	Description	DIN Thread (GL)	Pack Unit
29 310 28 07	DURAN® Screw Cap GL 45 with 2 hose connections EDPM Gasket	45	2
11 298 25	Syringe Filter (0.2 µm) with connector, non-sterile 0.2 µm filter and female Luer Slip to 5.8 mm male connector, with o-ring seal		2
11 298 29	Syringe Filter Connector only (without syringe filter), female Luer Slip to 5.8 mm male connector, with o-ring seal		2
11 527 52	40 mm ring gasket seal for GL 45 multifunction caps. Circular EPDM Seals 1.5 mm thick with a 40 mm outer and 29 mm inner diameter.		5

### DURAN® GL 45 Screw Cap with two hose connections

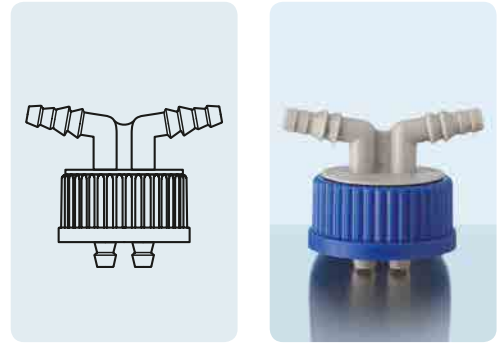

A  
121 °C

Tmax.  
140 °C

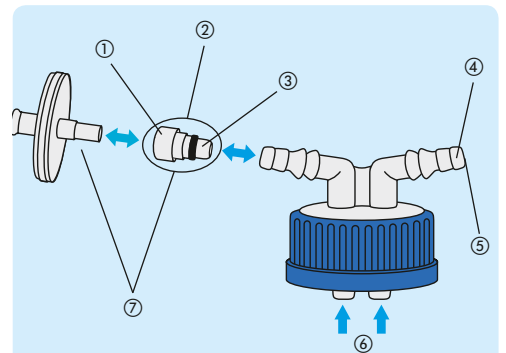

Screw cap GL 45 with 2 hose connections  
(29 310 28 07)

- ① Female Luer slip
- ② Syringe Filter Connector (11 298 29)
- ③ 5.8 mm connector with O-ring seal
- ④ Connector suitable for tubing with 6 – 9 mm inner diameter
- ⑤ 5.8 mm inner diameter
- ⑥ Connectors suitable for tubing with 6 – 9 mm inner diameter
- ⑦ Syringe Filter with connector (11 298 25)

## DURAN® GL 45 Connection System

screw cap GL 45, with two or three ports, GL 14 thread

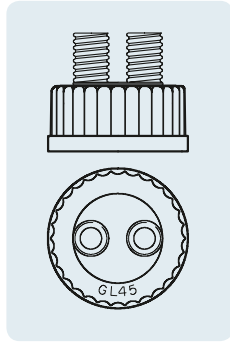

A  
121 °C

Tmax.  
140 °C

Materials used: PP and PTFE. Flexible modular system. Four different tubing diameters (1.6 mm; 3.0 mm; 3.2 mm and 6.0 mm) can be connected. Sterile pressure equalisation is possible through use of syringe filter. Unused ports can be sealed off with a red GL 14 screw cap.

Typical applications: Safe transfer of liquid media within a closed and sterile system (evaporation is reduced).

Cat. No.	Description	DIN Thread (GL)	Pack Unit
11 297 50	Screw cap GL 45, PP, 2 ports GL 14	45	2
11 297 51	Screw cap GL 45, PP, 3 ports GL 14	45	2
11 298 14	Screw cap GL 14 PP, for tubing connection	14	2
11 298 15	Insert for screw cap GL 14, ID 1.6 mm (1/16 inch)		1
11 298 16	Insert for screw cap GL 14, ID 3.0 mm (~1/8 inch)		1
11 298 17	Insert for screw cap GL 14, ID 3.2 mm (1/8 inch)		1
11 298 18	Insert for screw cap GL 14, ID 6.0 mm (~1/4 inch)		1
11 298 19	Spare syringe filter for pressure compensation, 0.2 µm		2
11 562 92	Screw cap, PBT, with PTFE coated seal, red, GL 14	14	2
11 377 99	Set for pressure compensation 2- and 3-port screw cap (incl. 0.2 µm syringe filter), GL 14	14	1

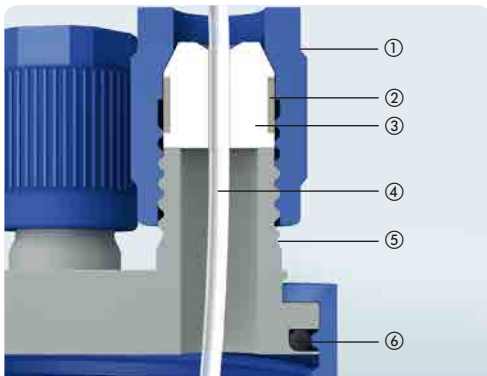

Schematic diagram of GL 45 connection system

- ① Screw cap GL 14 (PP)
- ② Silicone sealing ring on insert
- ③ PTFE insert / tubing connector
- ④ Tubing (not supplied)
- ⑤ Port (PP)
- ⑥ O-ring seal

DURAN® GL 25 connector caps with multiple ports are suitable for a range of applications where small volumes of liquid need to be sampled or dispensed, such as a media supply for small bioreactors, in a perfusion circuit for cell culture, or oxygenation of very small samples. The caps feature a GL 25 thread that fits 10 or 25 mL DURAN® bottles, and are available with two tubing connectors. The barbed male tubing connector are made from a surgical grade stainless steel (316L) and will fit tubing with a 3.2 mm (1/8") inner diameter. Construction materials are certified as approved for food contact, and offer a high temperature resistance (up to 180 °C). The caps are fully autoclavable (121 °C / 15 minutes) and reusable.

Cat. No.	DIN Thread (GL)	d (OD) (mm)	h (mm)	Pack Unit
<b>2-ports</b>				
29 260 13 01	25	33	32	1
<b>3-ports</b>				
29 261 13 02	25	33	32	1
<b>4-ports</b>				
29 262 13 03	25	33	32	1

## DURAN® Multiport Connector Cap GL 25

from PBT, GL 25, with 2, 3 or 4 ports

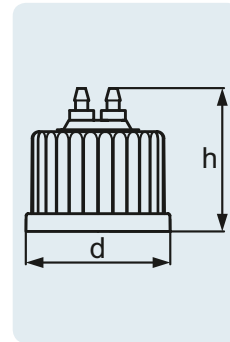

A  
121 °C

Tmax.  
180 °C

Self contained stirring system ideal for mixing processes. Stirrer shaft can be adjusted to the optimal position in either a 500 or 1000 mL DURAN® GL 45 bottles. Drive with standard magnetic stirrers up to 500 rpm. Significantly improved mixing performance compared to standard magnetic stirring bars. Multi-connector cap is compatible with the proven DURAN® connection systems; tubing with 1.6 mm to 6.0 mm bores can be used to add or remove liquid or gas. Fully autoclavable. Parts in contact with media conform to FDA requirements. Available separately or with bottle.

Typical applications: mixing chemicals, media or cultures in the DURAN® GL 45 laboratory bottle.

Cat. No.	Description	DIN Thread (GL)	Pack Unit
12 003 95	GL 45 stirred reactor, incl. 500 mL DURAN® GL 45 bottle, folding magnetic stirrer and GL 45 PP cap with 2 x GL 14 ports, 2 x GL 14 PBT caps red	45	1
12 003 96	GL 45 stirred reactor, incl. 1000 mL DURAN® GL 45 bottle, folding magnetic stirrer and GL 45 PP cap with 2 x GL 14 ports, 2 x GL 14 PBT caps red	45	1
12 003 91	Folding magnetic stirrer for GL 45 stirred reactor, incl. shaft	45	1
12 003 90	Spare screw cap 2-ports for GL 45 stirred reactor (excl. stirrer) with GL 14 screw cap (PP, blue)	45	1

## DURAN® GL 45 Stirred Reactor

materials used PP / PTFE / PEEK / stainless steel



A  
121 °C

Tmax.  
140 °C

## DURAN® Screw Cap with Temperature Probe Holder

GL 45

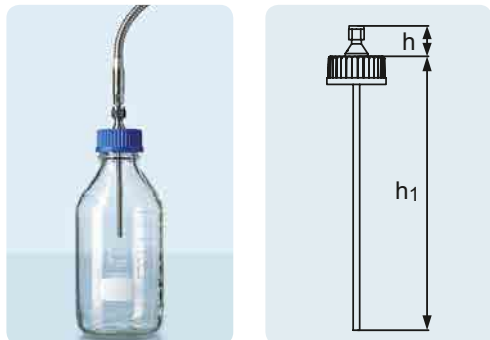

The DURAN® temperature probe holder GL 45 consists of a stainless steel holder that is permanently fitted into a blue DURAN® polypropylene GL 45 cap. The holder will accept the 6.0mm metal temperature measuring probes that are commonly used in laboratory autoclaves and sterilizers. Many DURAN® customers use an autoclave to sterilise the liquid contents of DURAN® original GL 45 laboratory bottles. Autoclaves use a metal temperature measuring probe to ensure that the correct sterilisation temperature as been reached.

Cat. No.	DIN Thread (GL)	d (OD) (mm)	h (mm)	h <sub>1</sub> (mm)	Pack Unit
29 991 28 01	45	54	21.3	25.7	1



## DURAN® Screw Cap with Thermocouple Holder

GL 45

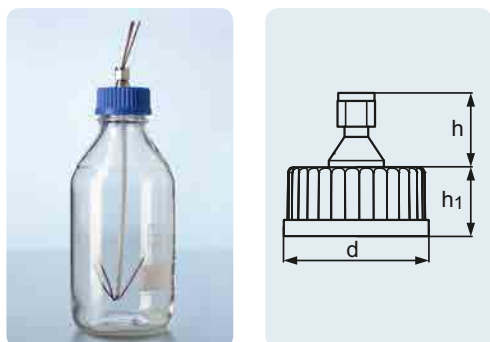

The DURAN® Screw Cap GL 45 Thermocouple Holder consists of a holder fitted into a blue DURAN® polypropylene GL 45 cap that accepts up to three separate thermocouple wires used in autoclaves or sterilizers. A particular issue when using thermocouples is that their very thin connection wires have a tendency to curl, making it difficult to maintain the tip (where the temperature is measured) in the correct position within the bottle during the entire sterilizing cycle. To overcome this problem, the DURAN® Screw Cap GL 45 Thermocouple Holder has a hollow PTFE tube to keep the wires straight.

Cat. No.	DIN Thread (GL)	d (OD) (mm)	h (mm)	h <sub>1</sub> (mm)	Pack Unit
29 992 28 02	45	54	21.3	248.7	1



## DURAN® Screw Cap GL 45 for pH Sensor

from PBT

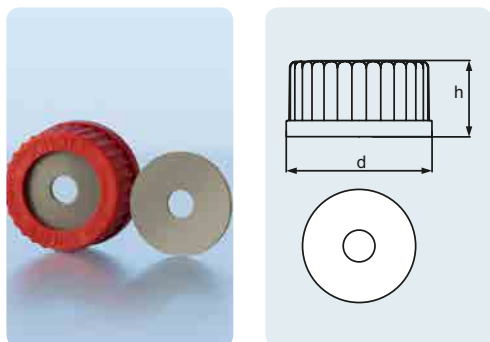

Cat. No.	DIN Thread (GL)	d (OD) (mm)	h (mm)	Pack Unit
11 713 95	45	54	28	1



# DURAN® *TILT*

## CHANGES EVERYTHING



As awarded by The Chicago Athenaeum:  
Museum of Architecture and Design.



Discover a new angle in cell culture media preparation, with the new tilting bottle system that turns usability into security.  
**DURAN® TILT Media Bottle System.**



[www.duran-tilt.com](http://www.duran-tilt.com)



**DURAN  
WHEATON  
KIMBLE**

Excellence in your hands

### Silicone Bottle Holder

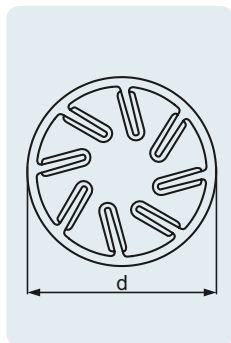

The holder helps stabilise bottles during activities such as liquid dispensing or pipetting. The flexible ribs accommodate both round and square bottles with diameters or base widths of between 75 mm and 120 mm. The solid silicone construction makes the holder autoclavable, durable, and chemically resistant.

Cat. No.	d (OD) (mm)	h (mm)	Colour	Pack Unit
29 213 54 01	165	40	grey	1

### DURAN® TILT Media Bottle

GL 56

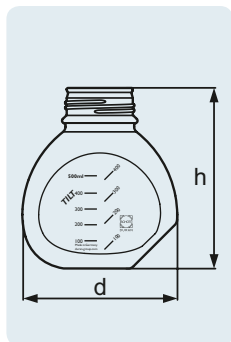

The DURAN® TILT bottle has two positions: upright for filter sterilization or storage, and tilted at 45° for pipetting. The bottle systems allows working with cell culture media under sterile conditions in biosafety cabinets and clean hoods.

Cat. No.	Capacity (mL)	DIN Thread (GL)	d (OD) (mm)	h (mm)	Pack Unit
with screw cap and pouring ring from PP (blue)					
21 891 44 59	500	56	124	148	4



### DURAN® TILT Screw Cap

GL 56, from PP

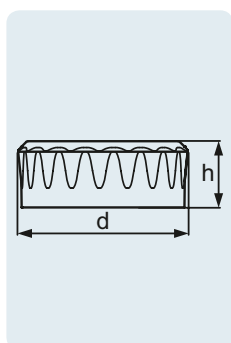

The ergonomic cap is easy to open and close. Made from non-cytotoxic materials.

Cat. No.	DIN Thread (GL)	d (OD) (mm)	h (mm)	Colour	Pack Unit
29 229 56 02	56	62	27	white	10





The Bottle Tags can be used on their own for colour identification or to secure the protective Light Shield around the bottle. The GL 56 Bottle Tags are available in four colours: orange, yellow, blue and purple.

### DURAN® TILT Bottle Tag

GL 56, from silicone

Cat. No.	DIN Thread (GL)	Colour	Pack Unit
29 243 56 26	56	orange	20
29 243 56 34	56	yellow	20
29 243 56 59	56	blue	20
29 243 56 67	56	purple	20

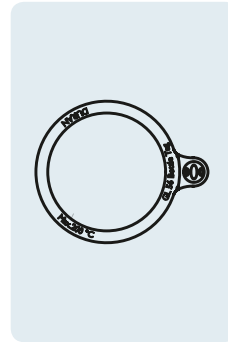

Tmax.  
200 °C

A  
121 °C

The DURAN® TILT Light Shield is a white silicone sleeve that covers 94 % of the bottle surface. The sleeve has a number of protective functions: it blocks damaging ultraviolet light (UV), protects the glass surface from damage, and facilitates safer handling. DURAN® TILT Light Shield includes four GL 56 Bottle Tags (Orange, Yellow, Blue, Purple) made from silicone.

### DURAN® TILT Light Shield

white, from silicone

Cat. No.	Colour	Pack Unit
29 243 56 01	white	4

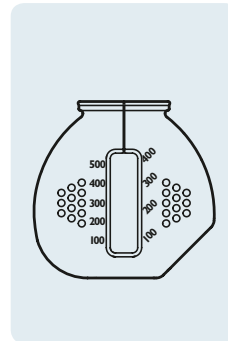

Tmax.  
200 °C

A  
121 °C

Designed for sterilization or clarification of aqueous cell culture media Supplied as a filter funnel unit for use with the DURAN® TILT bottle (with GL 45 thread adaptor) or 45mm media bottles. Comes in three different asymmetric pore sizes (0.1µm, 0.2µm, or 0.45µm). Raised moulded graduation marks for easy volume reading. Manufactured in a Class 100,000 clean room from Class VI, non-cytotoxic materials. Supplied sterile.

### DURAN® TILT Bottle Top Filter Unit

GL 45

Cat. No.	Description	Capacity (mL)	DIN Thread (GL)	d (OD) (mm)	h (mm)	Pack Unit
29 270 28 18	PES 0.1 µm	500	45	92	103	12
29 270 28 26	PES 0.2 µm	500	45	92	103	12
29 270 28 42	PES 0.45 µm	500	45	92	103	12

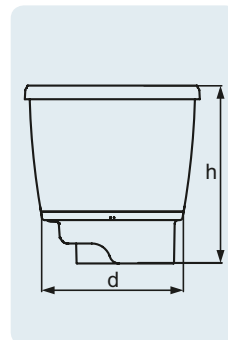

Retrace Code

## DURAN® TILT Adaptor

GL 45 / GL 56, from PTFE

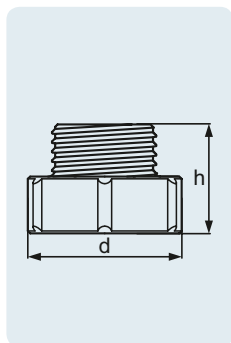

The re-usable adaptor (GL 45 external / GL 56 internal) allows the use of the DURAN® TILT bottle with 45 mm filtration units for the filter sterilisation of cell culture media. Manufactured from inert PTFE; can be autoclaved and depyrogenised at 300 °C.

Cat. No.	Thread	d (OD) (mm)	h (mm)	Colour	Pack Unit
29 119 56 01	GL 45 / GL 56	65	46	white	1



## DURAN® TILT GL 56 Cap Labels

self-adhesive

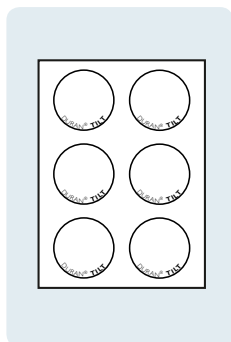

Careful labelling is very important to prevent mix-ups and mistakes. The GL 56 self-adhesive polyester cap labels can be used to clearly indicate the separate bottles of media for each cell line, preventing possible cross-contamination. A pack contains 60 screw cap labels.

Cat. No.	Description	Pack Unit
29 401 56 04	White polyester	1



With easy-to-read scale and large labelling field for easy marking, in fired-on, highly durable white ceramic. Complete with blue quick release closure (PP, integral lip seal) and pouring ring (PP) for drip-free pouring and clean, safe working. Service temperature limit of closure and pouring ring: +140 °C. Special thread means opening takes less than a turn. The 80 mm wide outer diameter of the bottle mouth permits easy filling and pouring out of powders and viscous substances.

Typical applications: storage, transport, safekeeping and sampling of substances, easy to use with granulated material, powders and viscous media, sampling of hot media.

### DURAN® GLS 80® Laboratory Bottle Wide Mouth

with GLS 80® thread

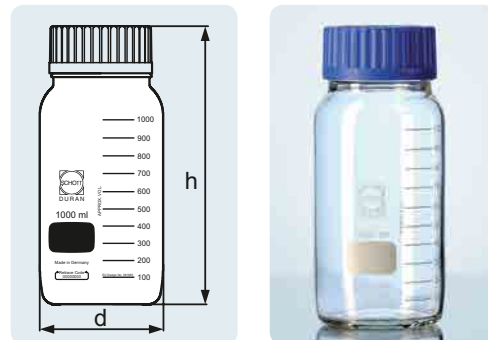

Cat. No.	Capacity (mL)	Thread	d (OD) (mm)	h (mm)	Pack Unit
with screw cap and pouring ring from PP (blue)					
21 860 36 56	250	80	95	110	10
11 126 27	500	80	101	153	10
11 127 13	1 000	80	101	223	10
11 127 15	2 000	80	136	253	10
21 860 69 53	3 500	80	160	276	1
11 139 49	5 000	80	182	315	1
11 139 50	10 000	80	227	390	1
11 139 51	20 000	80	288	485	1
12 002 65	30 000	80	340	548	1
12 001 54	50 000	80	400	590	1
without screw cap and pouring ring from PP (blue), clear					
21 860 36 07	250	80	95	105	10
11 783 92	500	80	101	148	10
11 784 24	1 000	80	101	218	10
11 784 25	2 000	80	136	248	10
21 860 69 04	3 500	80	160	271	1
11 784 26	5 000	80	182	310	1
11 784 27	10 000	80	227	385	1
11 784 28	20 000	80	288	480	1

## DURAN® GLS 80® Laboratory Bottle Wide Mouth Amber

with GLS 80®, USP <660> and USP <671> (Spectral Transmission) compliant



With easy-to-read scale and large labelling field for easy marking, in fired-on, highly durable white ceramic. Complete with blue quick release closure (PP, integral lip seal) and pouring ring (PP) for drip-free pouring and clean, safe working. Service temperature limit of closure and pouring ring: + 140 °C. Alongside easy handling, UV protection up to 500nm. Unchanged DURAN® properties within the bottle, as colouration is only to the outer surface. Very uniform, durable and chemically resistant amber colour due to use of innovative technology.

Typical applications: storage, transport and safekeeping of light-sensitive substances, easy to use with granulated material, powders and viscous media.

Cat. No.	Capacity (mL)	Thread	d (OD) (mm)	h (mm)	Pack Unit
with screw cap and pouring ring from PP (blue)					
21 866 36 53	250	80	95	110	10
11 601 46	500	80	101	153	10
11 601 47	1 000	80	101	223	10
11 601 48	2 000	80	136	253	10
21 866 69 59	3 500	80	160	276	1
11 601 49	5 000	80	182	315	1
11 601 50	10 000	80	227	390	1
11 601 51	20 000	80	288	485	1
without screw cap and pouring ring					
21 866 36 04	250	80	95	105	10
11 784 29	500	80	101	148	10
11 784 30	1 000	80	101	218	10
11 784 31	2 000	80	136	248	10
21 866 69 01	3 500	80	160	271	1
11 784 32	5 000	80	182	310	1
11 784 33	10 000	80	227	385	1
11 784 34	20 000	80	288	480	1

With easy-to-read scale. In fired-on, highly durable white ceramic. Complete with blue quick release closure (PP, integral lip seal) and pouring ring (PP) for drip-free pouring and clean, safe working. Service temperature limit of closure and pouring ring: +140 °C. Service temperature limit of the PU plastic coating: -30 °C to +135 °C. The coating provides scratch, leak and splinter protection and is ideally suited to both the transport and storage of hazardous media or valuable samples. UV protection up to approx. 380nm wavelength. High transparency. Suitable for microwaving.

Typical applications: storage, transport and safe handling of hazardous substances. Storage of high value viscous liquids, pastes and powder.

Cat. No.	Capacity (mL)	Thread	d (OD) (mm)	h (mm)	Pack Unit
with screw cap and pouring ring from PP (blue)					
21 865 36 52	250	80	95	110	10
11 601 52	500	80	101	153	10
11 601 63	1 000	80	101	223	10
11 601 64	2 000	80	136	253	10
21 865 69 53	3 500	80	160	276	1
11 601 65	5 000	80	182	315	1
without screw cap and pouring ring					
21 865 36 03	250	80	95	105	10
21 865 69 09	3 500	80	160	271	1

With easy-to-read scale and large labelling field for easy marking, in fired-on, highly durable white ceramic. Complete with blue quick release closure (PP, integral lip seal) and pouring ring (PP) for drip-free pouring and clean, safe working. Service temperature limit of closure and pouring ring: +140 °C. Service temperature limit of the PU plastic coating: -30 °C to +135 °C. The coating provides scratch, leak and splinter protection and is ideally suited to both the transport and storage of hazardous media or valuable samples. UV protection up to approx. 380nm wavelength. Suitable for microwaving.

Typical applications: storage, transport and safe handling of hazardous substances. Storage of high value viscous liquids, pastes and powder.

Cat. No.	Capacity (mL)	Thread	d (OD) (mm)	h (mm)	Pack Unit
with screw cap and pouring ring from PP (blue)					
11 673 08	500	80	101	153	10
11 673 09	1 000	80	101	223	10
without screw cap and pouring ring					
21 866 44 36	500	80	101	148	10
21 866 54 32	1 000	80	101	218	10
21 866 63 34	2 000	80	136	248	10
21 866 73 39	5 000	80	182	310	1

## DURAN® GLS 80® Protect Laboratory Bottle Wide Mouth

with GLS 80® thread, plastic coated

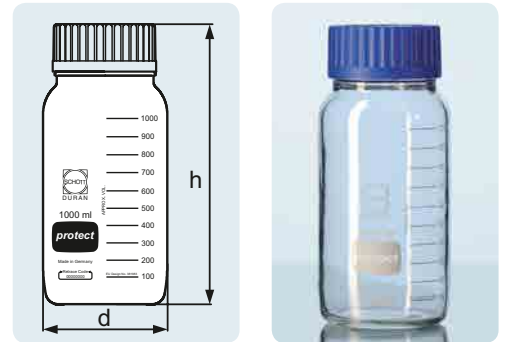

## DURAN® GLS 80® Protect Laboratory Bottle Wide Mouth Amber

with GLS 80®, plastic coated, USP <660> and USP <671> (Spectral Transmission) compliant

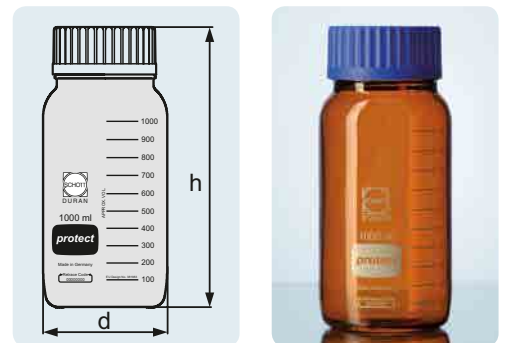

### DURAN® GLS 80® Baffled Bottle Wide Mouth

with GLS 80® thread



During mixing in standard DURAN® GLS 80® laboratory bottles, the liquid moves in a swirling motion that approximates a solid-body rotation. This is a very inefficient flow pattern, and very little mixing actually occurs. By adding three vertical baffles into the inner surface of the DURAN® GLS 80® bottles, the swirling motion is disrupted and an improvement of the top-to-bottom circulation occurs which produces a greater radial and more effective mixing.

Cat. No.	Capacity (mL)	Thread	d (OD) (mm)	h (mm)	Pack Unit
with screw cap and pouring ring from PP (blue)					
21 286 36 58	250	80	95	110	1
21 286 44 57	500	80	101	153	1
21 286 54 53	1 000	80	101	223	1

### DURAN® GLS 80® Double Walled Bottle Wide Mouth

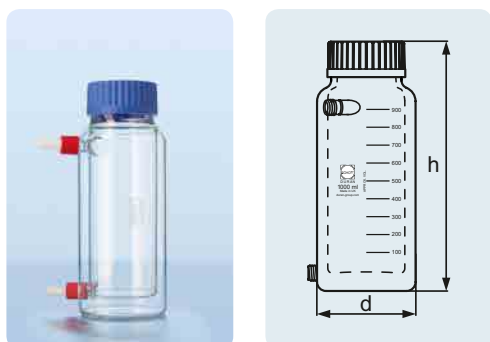

The DURAN® double walled, wide mouth bottles GLS 80® incorporate an integral jacket that isolates the contents from the external environment. Heated or cooled liquids can be circulated through the jacket to control the temperature within the screw topped DURAN® bottle. The DURAN® double walled bottles offer a sealable and more flexible alternative to open topped jacketed beakers.

Cat. No.	Capacity (mL)	Thread	d (OD) (mm)	h (mm)	Pack Unit
with screw cap and pouring ring from PP (blue)					
24 256 44 51	500	80	110	175	1
24 256 54 56	1 000	80	110	275	1

### DURAN® GLS 80® Production and Storage Bottle Carboys

with GLS 80® thread

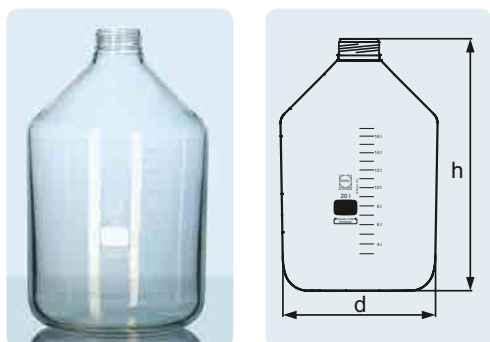

These larger sized bottles / carboys are ideal for bulk storage and handling of both liquid and solid intermediates and final formulations. Manufactured from Type 1 borosilicate 3.3 glass for durable performance and resistance to thermal stress. The glass conforms to American (USP), European (EP) and Japanese pharmacopoeia (JP) standards making the carboys ideal for pharmaceutical production applications. Manufactured with thickened, uniform side walls for higher mechanical strength. Retrace Code for batch traceability and conformance certification. Manufactured from inorganic materials (Certified BSE / TSE free). Suitable for high temperature sterilization, depyrogenisation or autoclaving. Feature large, permanent, easy-to-read, white enamel graduations marks. Available with customized logos, identification labeling or graduations Supplied without screw cap or pouring ring, but can be used in conjunction caps and connector systems.

Typical applications: Flat robust base is ideal for mixing processes with large magnetic stir bars.

Cat. No.	Capacity (mL)	Thread	d (OD) (mm)	h (mm)	Pack Unit
without screw cap and pouring ring					
11 602 20	10 000	80	228	385	1
11 601 10	20 000	80	289	480	1

These larger sized bottles / carboys are ideal for bulk storage and handling of both liquid and solid intermediates and final formulations. Manufactured from Type 1 borosilicate 3.3 glass for durable performance and resistance to thermal stress. The glass conforms to American (USP), European (EP) and Japanese pharmacopoeia (JP) standards making the carboys ideal for pharmaceutical production applications. Manufactured with thickened, uniform side walls for higher mechanical strength. Retrace Code for batch traceability and conformance certification. Manufactured from inorganic materials (Certified BSE / TSE free). Suitable for high temperature sterilization, depyrogenisation or autoclaving. Feature large, permanent, easy-to-read, white enamel graduations marks. External polyurethane protect coating for enhanced scratch resistance. Available with customized logos, identification labeling or graduations Supplied without screw cap or pouring ring, but can be used in conjunction caps and connector systems.

Typical applications: Flat robust base is ideal for mixing processes with large magnetic stir bars.

Cat. No.	Capacity (mL)	Thread	d (OD) (mm)	h (mm)	Pack Unit
without screw cap and pouring ring					
21 991 86 03	10 000	80	228	385	1
21 991 91 02	20 000	80	289	480	1

### DURAN® GLS 80® Protect Coated Production Bottle carboys

with GLS 80® thread, plastic coated

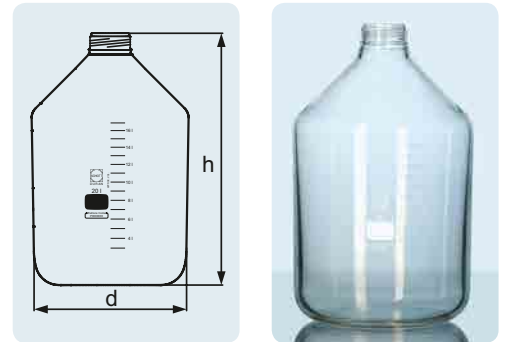

Permits opening and closing of the DURAN® GLS 80® bottle with only a three-quarter turn. A matching PP pouring ring is also available, permitting clean, drip-free use.

Cat. No.	Thread	d (OD) (mm)	h (mm)	Pack Unit
screw cap				
11 127 16	80	87	40	10
Pouring ring				
11 601 66	80		6.85	10

### DURAN® GLS 80® Quick Release Screw Cap

from PP, blue, with lip seal

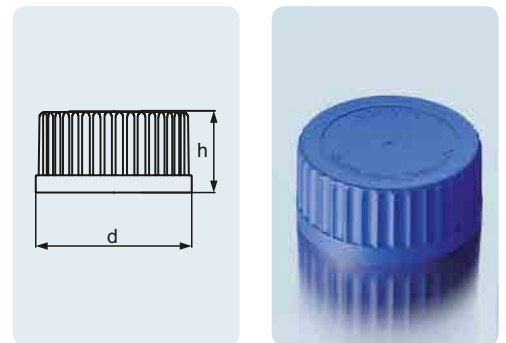

## DURAN® GLS 80® Membrane Vented Screw Cap

from PP, blue, with welded-in PTFE membrane for pressure equalisation

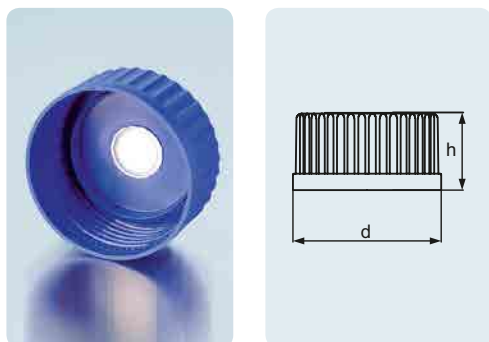

**A**  
121 °C

**Tmax.**  
140 °C

For GLS 80® thread. Ideal for autoclaving processes because the 0.2 micron ePTFE membrane permits pressure equalisation and screw tight sealing. Hence the risk of contamination is greatly reduced. Ingress of liquids or solids is prevented and the bottle contents remain sterile.

Typical applications: storage or transport of gas generating media, autoclaving of media.

Cat. No.	Thread	d (OD) (mm)	h (mm)	Pack Unit
29 118 91 05	80	87	40	2

## DURAN® GLS 80® High Temperature Screw Cap

with cap liner, PSU material

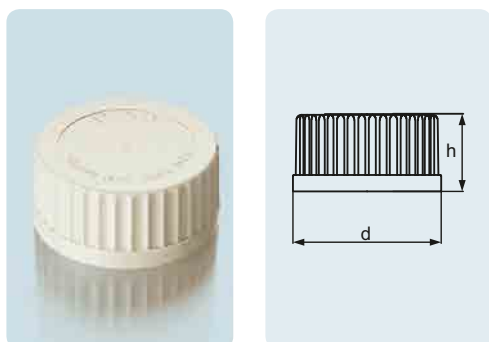

**A**  
121 °C

**Tmax.**  
180 °C

The material used is a special compound based on polyarylsulphone. Consequently the chemical, thermal and mechanical properties of the material are noticeably improved and matched to laboratory requirements. Thanks to the thread, the DURAN® GLS 80® bottle can be opened or closed with only a three-quarter turn. The seal, which is coated on both sides with PTFE, ensures the bottle can be tightly sealed (cap liner: Platinum-cured silicone). A matching PTFE pouring ring is also available, permitting clean, drip-free use.

Cat. No.	Thread	d (OD) (mm)	h (mm)	Pack Unit
screw cap				
11 658 88	80	88.5	40	5
pouring ring				
11 673 07	80		6.85	5
replacement cap liner				
11 529 21	80	79	3.1	5

## DURAN® GLS 80® Connection Cap System for Overhead Mixer

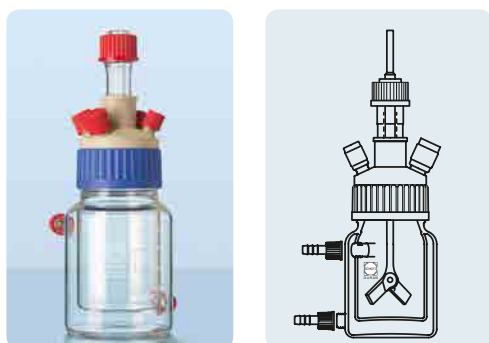

**A**  
121 °C

**Tmax.**  
140 °C

For use with overhead laboratory mixers, Materials used: PP and PTFE. Flexible modular system with a central ground joint 29/32 fitting. Five different tubing diameters (3.2 mm; 6.0 mm; 8.0 mm; 10.0 mm and 12.0 mm) can be used by changing the inserts. Sterile pressure equalisation is possible by using the syringe filter. Unused ports can be closed with a blind cap. Components: Screw Cap GLS 80® with NS 29/32 (Cat. no. 11 601 75), KPG® Stirrer Shaft WS 10 (Cat. no. 24 583 84 04), KPG® Stirrer Bearing HB 10 (Cat. no. 24 750 09 06), Screw Cap GL 14 (Cat. no. 29 240 08 14, 2 pieces) and Screw Cap GL 18 (Cat. no. 29 240 11 16, 2 pieces). Not supplied with GLS 80® bottle.

Typical applications: safe transfer of liquid media within a closed and sterile system (evaporation is reduced).

Cat. No.	Pack Unit
29 120 91 04	1



Materials used: PP and PTFE. Flexible modular system with a central ground joint 29/32 fitting. Five different tubing diameters (3.2 mm; 6.0 mm; 8.0 mm; 10.0 mm and 12.0 mm) can be connected. Sterile pressure equalisation is possible by using the syringe filter. Unused ports can be closed with a blind cap.

Typical applications: safe transfer of liquid media within a closed and sterile system (evaporation is reduced).

Cat. No.	Thread	d (OD) (mm)	h (mm)	Pack Unit
11 601 75	80	87	94	2

### DURAN® GLS 80® Connection System

screw cap GLS 80®, with NS 29/32, with four ports GL 18 thread

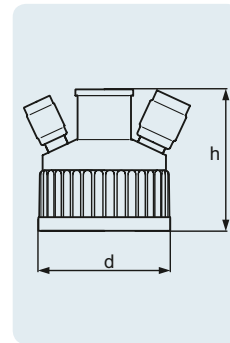

Cat. No.	d (OD) (mm)	d <sub>1</sub> (OD) (mm)	Pack Unit
11 529 13	78	63.5	5

### DURAN® O-Ring Gasket Seal from EPDM

for GLS 80® bottles

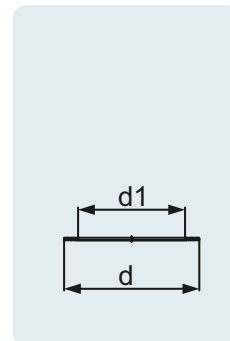

## DURAN® GLS 80® Connection Cap System

screw cap GLS 80®, with four ports, GL 18 thread, EPDM seal

Materials used: PP and PTFE. Flexible modular system. Five different tubing diameters (3.2mm; 6.0mm; 8.0mm; 10.0mm and 12.0mm) can be connected. Sterile pressure equalisation is possible by using the syringe membrane filter. Unused ports can be closed with a closed top GL 18 PBT cap.

Typical applications: safe transfer of liquid media within a closed and sterile system (evaporation is reduced).

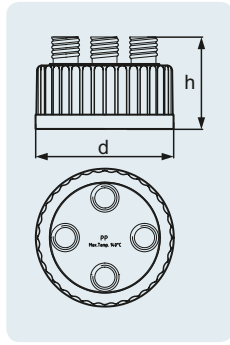

A  
121 °C

Tmax.  
140 °C

Cat. No.	Description	Thread	d (OD) (mm)	h (mm)	Pack Unit
29 310 91 03	GLS 80® 4-port EPDM seal	80	87	59	2
<b>Accessories</b>					
11 601 69	Insert for screw cap GL 18, ID 3.2mm				1
11 601 70	Insert for screw cap GL 18, ID 6.0mm				1
11 601 71	Insert for screw cap GL 18, ID 8.0mm				1
11 601 72	Insert for screw cap GL 18, ID 10.0mm				1
11 601 73	Insert for screw cap GL 18, ID 12.0mm				1
11 601 74	Screw cap for tube connection, blue, GL 18				2
11 601 67	Pressure equalisation cap set for 4-port, GL 18				1
11 706 82	Blanking screw cap, red, PBT, GL 18				2

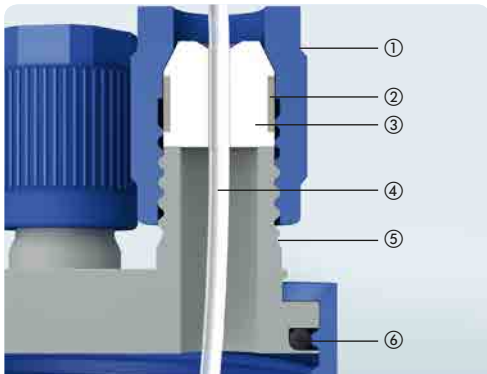

Schematic diagram of GLS 80® connection system

- ① Screw cap GL 18 (PP)
- ② Silicone sealing ring on insert
- ③ PTFE insert / tubing connector
- ④ Tubing (not supplied)
- ⑤ Port (PP)
- ⑥ O-ring seal

The GLS 80® stirred reactor is suitable for a wide range of laboratory mixing processes. The connections (2 x GL 14 and 2 x GL 18) provided permit addition or removal of media from the bottle during the mixing process. The whole unit can be autoclaved and is therefore suitable for biological applications. By using components from the GLS 80® connection system, an additional media bottle (Tubing outer diameter: 1.6 – 12.0 mm) can be connected or a sterile pressure equalizer attached. Drive for the stirrer may provided by a standard commercial magnetic stirrer. The variable stirrer shaft can be used in DURAN® GLS 80® laboratory glass bottles (1 000 mL and 2 000 mL) and provides notably improved mixing in comparison with standard magnetic stir bars. The stirrer unit is interchangeable and can be used up to 500 rpm is possible.

Typical applications: mixing of liquids, dissolving of solids, simple fermentation processes.

## DURAN® GLS 80® Stirred Reactor

materials used: PP / PTFE / PEEK / stainless steel

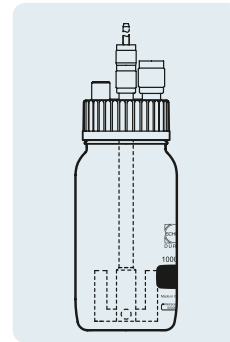

Cat. No.	Description	Thread	Anchor stirrer d (mm)	Impeller stirrer d (mm)	Pack Unit
12 003 79	Stirred reactor cap, stirrer anchor type, magnetic, complete with shaft, connection and screw cap	80	62		1
21 263 91 07	Stirred reactor anchor type, magnetic, complete with DURAN® GLS 80® bottle (250 mL), 1x GLS 80® cap (PP, grey / blue), 1x GL 14 screw cap (PP, blue), 2x GL 14 screw cap (PBT red), 2x GL 18 screw cap (PBT red)	80	62		
12 003 80	Stirred reactor anchor type, magnetic, complete with DURAN® GLS 80® bottle (1 000 mL), 1x GLS 80® cap (PP, grey / blue), 1x GL 14 screw cap (PP, blue), 2x GL 14 screw cap (PBT red), 2x GL 18 screw cap (PBT red)	80	62		1
12 003 81	Stirred reactor anchor type, magnetic, complete with DURAN® GLS 80® bottle (2 000 mL), 1x GLS 80® screw cap (PP, grey / blue), 1x GL 14 screw cap (PP, blue), 2x GL 14 screw cap (PBT red), 2x GL 18 screw cap (PBT red)	80	62		1
<b>Accessories for GLS 80® stirred reactor</b>					
12 003 82	Stirrer impeller type, magnetic, for GLS 80® stirred reactor			62	1
12 003 83	Stirrer anchor type, magnetic, for GLS 80® stirred reactor		62		1
12 003 85	Spare screw cap for GLS 80® stirred reactor, PP, blue/grey	80			1
12 003 86	Spare shaft for GLS 80® stirred reactor, stainless steel, including PEEK connection				1

### DURAN® Reagent Bottle Wide Neck

With precision ground neck. All glass components, therefore also suitable for storage of aggressive media, which could attack plastic parts.



Typical application: storage of powders.

Cat. No.	Capacity (mL)	Neck	d (OD) (mm)	h (mm)	Remark	Pack Unit
Neck with standard ground joint and glass flat-head stopper						
21 185 17 07	50	24/20	44	79		10
21 185 24 03	100	29/22	52	97		10
21 185 36 05	250	34/35	70	133		10
21 185 44 04	500	45/40	86	163		10
21 185 54 09	1 000	60/46	107	201		10
21 185 63 02	2 000	60/46	133	247		10
21 185 73 07	5 000	85/55	182	358	No norm available.	1
21 185 86 03	10 000	85/55	229	443	No norm available.	1
21 185 91 02	20 000	85/55	290	570	No norm available.	1
Neck with standard ground joint						
21 184 17 06	50	24/20	44	79		10
21 184 24 02	100	29/22	52	97		10
21 184 36 04	250	34/35	70	133		10
21 184 44 03	500	45/40	86	163		10
21 184 54 08	1 000	60/46	107	201		10
21 184 63 01	2 000	60/46	133	247		10
21 184 73 06	5 000	85/55	182	358	No norm available.	1
21 184 86 02	10 000	85/55	229	443	No norm available.	1
21 184 91 01	20 000	85/55	290	570	No norm available.	1

### DURAN® Reagent Bottle Wide Neck Amber

With precision ground neck. All glass components, therefore also suitable for storage of aggressive media, which could attack plastic parts. Unchanged DURAN® properties within the bottle, as colouration is only on the outer surface. Very uniform, durable and chemically resistant amber colour due to use of innovative technology.

USP <660> and USP <671> (Spectral Transmission) compliant



Typical application: storage of powders.

Cat. No.	Capacity (mL)	Neck	d (OD) (mm)	h (mm)	Remark	Pack Unit
Neck with standard ground joint and glass flat-head stopper						
21 188 17 01	50	24/20	44	79		10
21 188 24 06	100	29/22	52	97		10
21 188 36 08	250	34/35	70	133		10
21 188 44 07	500	45/40	86	163		10
21 188 54 03	1 000	60/46	107	201		10
21 188 63 05	2 000	60/46	133	247		10
21 188 73 01	5 000	85/55	182	358	No norm available.	1
21 188 86 06	10 000	85/55	229	443	No norm available.	1
21 188 91 05	20 000	85/55	290	570	No norm available.	1

With precision ground neck. All glass components, therefore also suitable for storage of aggressive media, which could attack plastic parts.

Typical application: storage of liquids.

Cat. No.	Capacity (mL)	Neck	d (OD) (mm)	h (mm)	Remark	Pack Unit
Neck with standard ground joint and glass flat-head stopper						
21 165 08 09	10	10/19	28	52	Non ISO size.	10
21 165 14 02	25	12/21	36	64		10
21 165 17 02	50	14/15	42	80		10
21 165 24 07	100	14/15	52	96		10
21 165 36 09	250	19/26	70	130		10
21 165 44 08	500	24/29	86	164		10
21 165 54 04	1 000	29/32	107	200		10
21 165 63 06	2 000	29/32	134	248		10
21 165 73 02	5 000	45/40	182	323		1
21 165 86 07	10 000	60/46	227	398		1
21 165 91 06	20 000	60/46	288	492		1
Neck with standard ground joint						
21 164 08 08	10	10/19	28	52		10
21 164 14 01	25	12/21	36	64		10
21 164 17 01	50	14/15	42	80		10
21 164 24 06	100	14/15	52	96		10
21 164 36 08	250	19/26	70	130		10
21 164 44 07	500	24/29	86	164		10
21 164 54 03	1 000	29/32	107	200		10
21 164 63 05	2 000	29/32	134	248		10
21 164 73 01	5 000	45/40	182	323		1
21 164 86 06	10 000	60/46	227	398		1
21 164 91 05	20 000	60/46	288	492		1

## DURAN® Reagent Bottle Narrow Neck

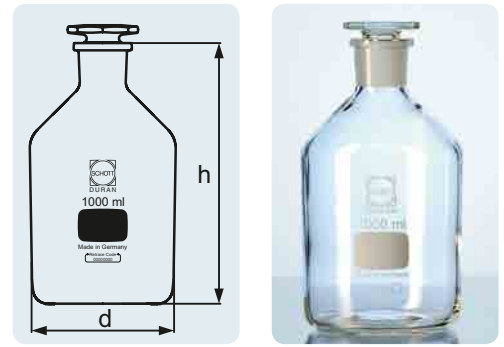

With precision ground neck. All glass components, therefore also suitable for storage of aggressive media, which could attack plastic parts. Unchanged DURAN® properties within the bottle, as colouration is only on the outer surface. Very uniform, durable and chemically resistant amber colour due to use of innovative technology.

Typical application: storage of liquids.

Cat. No.	Capacity (mL)	Neck	d (OD) (mm)	h (mm)	Pack Unit
Neck with standard ground joint and glass flat-head stopper					
21 168 14 05	25	12/21	36	64	10
21 168 17 05	50	14/15	42	80	10
21 168 24 01	100	14/15	52	96	10
21 168 36 03	250	19/26	70	130	10
21 168 44 02	500	24/29	86	164	10
21 168 54 07	1 000	29/32	107	200	10
21 168 63 09	2 000	29/32	134	248	10
21 168 73 05	5 000	45/40	182	323	1
21 168 86 01	10 000	60/46	227	398	1
21 168 91 09	20 000	60/46	288	492	1

## DURAN® Reagent Bottle Narrow Neck Amber

USP <660> and USP <671> (Spectral Transmission) compliant

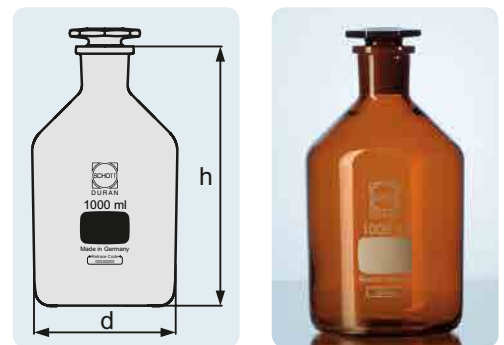

## Reagent Bottle Wide Neck from Soda-lime Glass

neck with standard ground joint



ISO  
4796-2

A maximum usage temperature of +100 °C is recommended. Thermal shock resistance 30 K. Hydrolytic class 3. Note on using DURAN® glass stoppers with soda-lime glass bottles: If the bottle and the stopper have a temperature difference greater than 30 °C, the glass stoppers can become stuck!

Cat. No.	Capacity (mL)	Neck	d (OD) (mm)	h (mm)	Pack Unit
with standard ground glass flat-head stopper					
23 185 17 08	50	24/20	44	79	10
23 185 24 04	100	29/22	52	97	10
23 185 36 06	250	34/24	71	129	10
23 185 44 05	500	45/40	86	164	10
23 185 54 01	1000	60/46	107	200	10
without stoppers					
23 184 17 07	50	24/20	44	79	10
23 184 24 03	100	29/22	52	97	10
23 184 36 05	250	34/24	71	129	10
23 184 44 04	500	45/40	86	164	10
23 184 54 09	1000	60/46	107	200	10

## Reagent Bottle Wide Neck, Amber from Soda-lime Glass

neck with standard ground joint

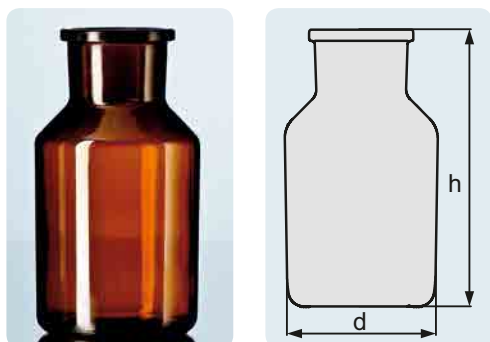

ISO  
4796-2

A maximum usage temperature of +100 °C is recommended. Thermal shock resistance 30 K. Hydrolytic class 3. Note on using DURAN® glass stoppers with soda-lime glass bottles: If the bottle and the stopper have a temperature difference greater than 30 °C, the glass stoppers can become stuck!

Cat. No.	Capacity (mL)	Neck	d (OD) (mm)	h (mm)	Pack Unit
with standard ground glass flat-head stopper					
23 188 24 07	100	29/22	52	97	10
23 188 36 09	250	34/24	71	129	10
23 188 44 08	500	45/27	86	164	10
23 188 54 04	1000	60/46	107	200	10
without stoppers					
23 187 24 06	100	29/22	52	97	10
23 187 36 08	250	34/24	71	129	10
23 187 44 07	500	45/27	86	164	10
23 187 54 03	1000	60/46	107	200	10

## Reagent Bottle Narrow Neck from Soda-lime Glass

neck with standard ground joint



ISO  
4796-2

A maximum usage temperature of +100 °C is recommended. Thermal shock resistance 30 K. Hydrolytic class 3. Note on using DURAN® glass stoppers with soda-lime glass bottles: If the bottle and the stopper have a temperature difference greater than 30 °C, the glass stoppers can become stuck!

Cat. No.	Capacity (mL)	Neck	d (OD) (mm)	h (mm)	Pack Unit
with standard ground glass flat-head stopper					
23 165 24 08	100	14/15	52	96	10
23 165 36 01	250	19/26	72	130	10
23 165 44 09	500	24/29	89	165	10
23 165 54 05	1000	29/32	110	200	10
without stoppers					
23 164 24 07	100	14/15	52	96	10
23 164 36 09	250	19/26	72	130	10
23 164 44 08	500	24/29	89	165	10
23 164 54 04	1000	29/32	110	200	10

A maximum usage temperature of + 100 °C is recommended. Thermal shock resistance 30 K. Hydrolytic class 3. Note on using DURAN® glass stoppers with soda-lime glass bottles: If the bottle and the stopper have a temperature difference greater than 30 °C, the glass stoppers can become stuck!

## Reagent Bottle Narrow Neck, Amber from Soda-lime Glass

neck with standard ground joint

Cat. No.	Capacity (mL)	Neck	d (OD) (mm)	h (mm)	Pack Unit
with standard ground glass flat-head stopper					
23 168 17 06	50	14/15	42	80	10
23 168 24 02	100	14/15	52	96	10
23 168 36 04	250	19/26	72	130	10
23 168 44 03	500	24/29	89	165	10
23 168 54 08	1 000	29/32	110	200	10
without stoppers					
23 167 17 05	50	14/15	42	80	10
23 167 24 01	100	14/15	52	96	10
23 167 36 03	250	19/26	72	130	10
23 167 44 02	500	24/29	89	165	10
23 167 54 07	1 000	29/32	110	200	10

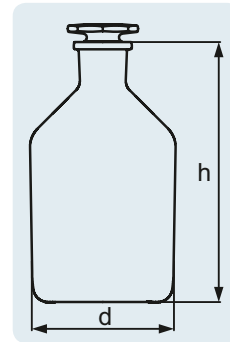

ISO  
4796-2

From borosilicate 3.3 glass. Note on using DURAN® glass stoppers with soda-lime glass bottles: If the bottle and the stopper have a temperature difference greater than 30 °C, the glass stoppers can become stuck!

## DURAN® Glass Stopper

with standard ground joint, octagonal

Cat. No.	Neck	Pack Unit
solid		
21 624 03 07	10/19	10
21 624 04 01	12/21	10
21 624 07 01	19/26	10
21 624 08 04	24/29	10
semi-hollow		
21 624 09 07	29/32	10
21 624 11 06	34/35	1
21 624 12 09	45/40	1
21 624 13 03	60/46	1
21 624 16 03	85/55	1

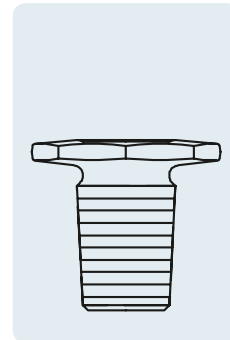

DIN  
12252

From borosilicate 3.3 glass. Note on using DURAN® glass stoppers with soda-lime glass bottles: If the bottle and the stopper have a temperature difference greater than 30 °C, the glass stoppers can become stuck!

## DURAN® Glass Stopper Amber

with standard ground joint, octagonal

Cat. No.	Neck	Pack Unit
solid		
21 627 03 01	10/19	10
21 627 04 04	12/21	10
21 627 08 07	24/29	10
semi-hollow		
21 627 09 01	29/32	10
21 627 11 09	34/35	1
21 627 12 03	45/40	1
21 627 13 06	60/46	1
21 627 16 06	85/55	1

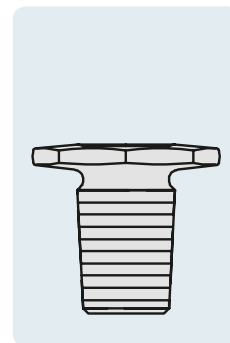

DIN  
12252

### Glass Stopper from SBW glass

with standard ground joint, octagonal

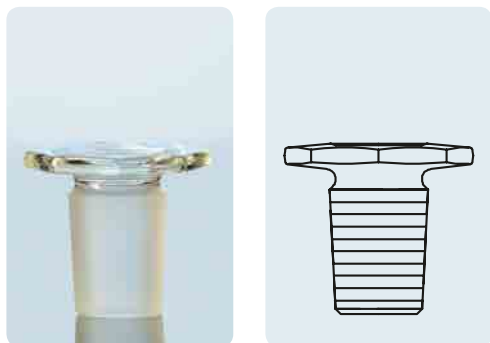

DIN  
12252

Cat. No.	Neck	Pack Unit
solid		
24 624 06 04	14/23	10

### Glass Stopper Amber from SBW glass

with standard ground joint, octagonal

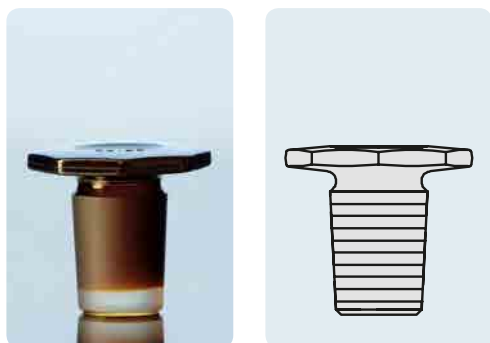

DIN  
12252

Cat. No.	Neck	Pack Unit
solid		
24 627 06 07	14/23	10
24 627 07 01	19/26	10

### DURAN® Glass Stopper

with short ground joint, octagonal

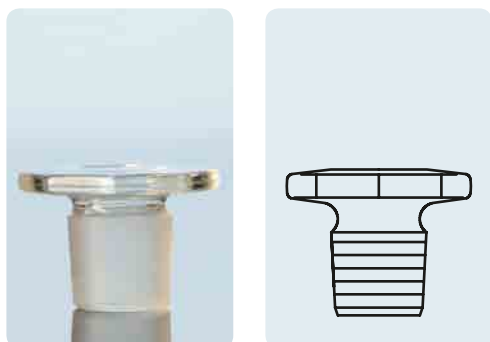

DIN  
12252

From borosilicate 3.3 glass. Note on using DURAN® glass stoppers with soda-lime glass bottles: If the bottle and the stopper have a temperature difference greater than 30 °C, the glass stoppers can become stuck!

Cat. No.	Neck	Pack Unit
semi-hollow		
21 625 09 08	29/22	10



Cat. No.	Neck	Pack Unit
solid		
24 625 06 05	14/15	10
24 625 08 02	24/20	10
semi-hollow		
24 625 09 05	29/22	10
24 625 11 04	34/24	1
24 625 12 07	45/27	1

### Glass Stopper from SBW glass

with short ground joint, octagonal



DIN  
12252

From borosilicate 3.3 glass. Note on using DURAN® glass stoppers with soda-lime glass bottles: If the bottle and the stopper have a temperature difference greater than 30 °C, the glass stoppers can become stuck!

Cat. No.	Neck	Pack Unit
solid		
24 622 06 02	14/23	10
21 622 07 08	19/26	10

### DURAN® Glass Stopper

ground conical, for reagent bottles, oxygen bottles according to Winkler



Cat. No.	Neck	Remark	Pack Unit
29 204 02 09	7/16		10
29 204 03 03	10/19		10
29 204 04 06	12/21		10
29 204 06 03	14/23		10
29 204 07 06	19/26		10
29 204 08 09	24/29		10
29 204 09 03	29/32		10
29 204 11 02	34/35	Non-DIN size.	1
29 204 12 05	45/40	Non-DIN size.	1
29 204 13 08	60/46	Non-DIN size.	1
29 204 16 08	85/55	Non-DIN size.	1

### DURAN® Plastic Stopper

from polyethylene, octagonal

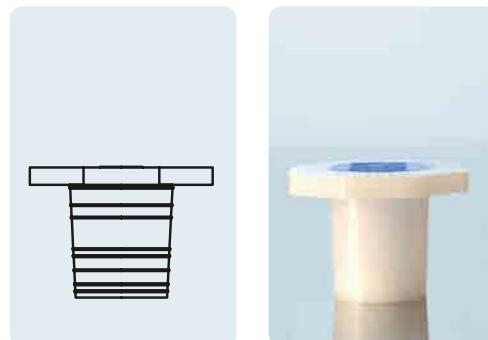

DIN  
12254

Tmax.  
80 °C

### DURAN® Acid Bottle

with standard ground "pennyhead" stopper, conical shoulders, interchangeable glass cap



In addition to the ground stopper, a glass cap with ground joint is supplied. This provides an improved seal and protection against acid vapours.

Cat. No.	Description	Capacity (mL)	Neck	d (OD) (mm)	h (mm)	Pack Unit
21 275 24 08		100	19/17	55	145	10
21 275 36 01		250	19/17	75	180	10
21 275 44 09		500	24/20	82	220	10
21 275 54 05		1 000	29/32	109	260	10
<b>Components</b>						
21 273 24 06	Bottle	100	19/17	55	104	10
21 273 36 08	Bottle	250	19/17	75	133	10
21 273 44 07	Bottle	500	24/20	87	166	10
21 273 54 03	Bottle	1 000	29/32	108	208	10
21 274 24 07	Cap for Bottle 100 mL			48	73	10
21 274 36 09	Cap for bottle 250 mL			55	75	10
21 274 44 08	Cap for Bottle 500 mL			66	87	10
21 274 54 04	Cap for Bottle 1 000 mL			75	103	10

### DURAN® Acid Bottle Amber

with standard ground "pennyhead" stopper, conical shoulders, interchangeable glass cap

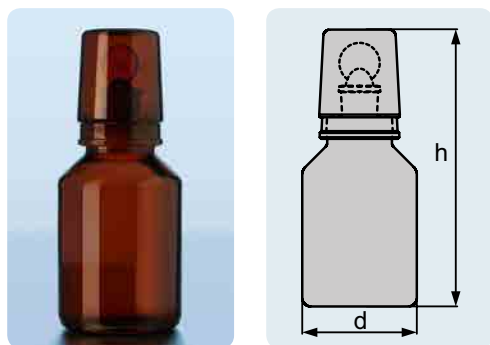

In addition to the ground stopper, a glass cap with ground joint is supplied. This provides an improved seal and protection against acid vapours.

Cat. No.	Description	Capacity (mL)	Neck	d (OD) (mm)	h (mm)	Pack Unit
21 275 24 65		100	19/17	55	145	10
21 275 36 67		250	19/17	75	180	10
21 275 44 66		500	24/20	82	220	10
21 275 54 62		1 000	29/32	109	260	10
<b>Components</b>						
21 273 24 63	Bottle	100	19/17	55	104	10
21 273 36 65	Bottle	250	19/17	76	133	10
21 273 44 64	Bottle	500	24/20	87	166	10
21 273 54 69	Bottle	1 000	29/32	108	208	10
21 274 24 64	Cap for Bottle 100 mL			48	73	10
21 274 36 66	Cap for Bottle 250 mL			55	75	10
21 274 44 65	Cap for Bottle 500 mL			66	87	10
21 274 54 61	Cap for Bottle 1 000 mL			75	103	10

For dosing use with the dropping pipette. Spare pipettes, clear glass, Cat. No. 23 271 17 09 and 23 271 24 05 (Quantity 10); Rubber teats, transparent, Cat. No. 29 200 01 02 (Quantity 100).

Cat. No.	Capacity (mL)	Neck	h (mm)	Pack Unit
23 270 17 08	50	14/15	79	10
23 270 24 04	100	14/15	105	10

### Dropping Bottle from Soda-lime Glass

with interchangeable clear glass pipette standard ground joint, complete with rubber teats

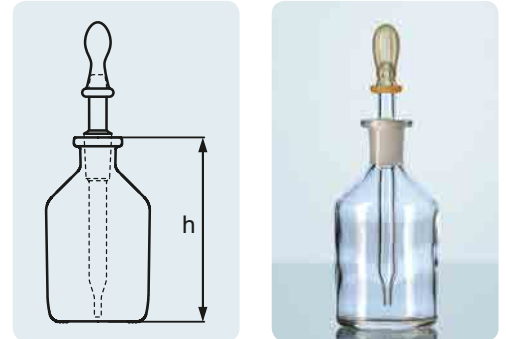

For dosing use the dropping pipette. Spare pipettes, clear glass, Cat. No. 23 271 17 09 and 23 271 24 05 (Quantity 10); rubber teats, transparent, Cat. No. 29 200 01 02 (Quantity 100).

Cat. No.	Capacity (mL)	Neck	h (mm)	Remark	Pack Unit
23 270 17 65	50	14/15	79		10
23 270 24 61	100	14/15	105	from borosilicate 3.3	10

### Dropping Bottle Amber from Soda-lime Glass

with interchangeable clear glass pipette standard ground joint, complete with rubber teats

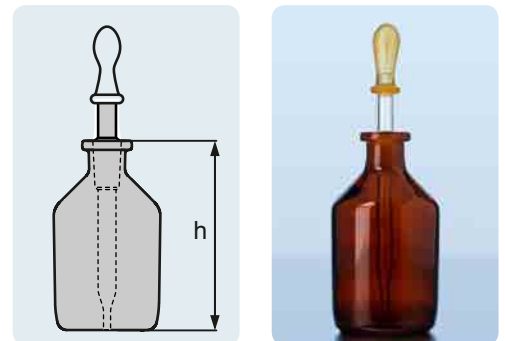

Cat. No.	d <sub>1</sub> (OD) (mm)	h (mm)	Pack Unit
29 200 01 02	15	35	100

### Rubber Teat transparent

from natural rubber



### DURAN® Aspirator (levelling) Bottle

with plain neck and bottom sidearm

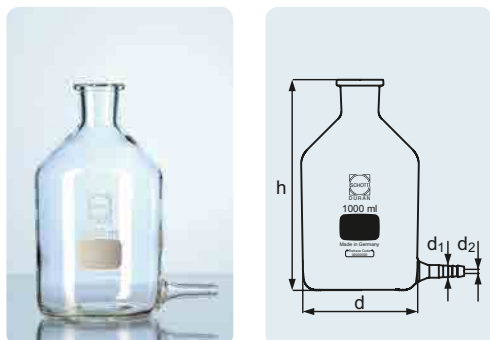

Useful as a delivery or storage container for solutions. Outlet facilitates attachment of flexible tubing.

Cat. No.	Capacity (mL)	d (OD) (mm)	d <sub>1</sub> (OD) (mm)	d <sub>2</sub> (OD) (mm)	h (mm)	Pack Unit
24 708 36 03	250	73	11	5	130	10
24 708 44 02	500	89	11	5	164	10
24 708 54 07	1 000	111	11	5	200	1



### DURAN® Aspirator (levelling) Bottle

tubulated with standard ground joint, without stoppers, neck unground



Dosing of liquids is possible via an outlet.

Cat. No.	Capacity (mL)	Tubulature (NS)	d (OD) (mm)	h (mm)	Pack Unit
24 701 44 04	500	19/26	86	164	10
24 701 54 09	1 000	19/26	107	200	10
24 701 63 02	2 000	19/26	134	249	1
24 701 73 07	5 000	29/32	182	320	1
24 701 86 03	10 000	29/32	228	398	1
24 701 91 02	20 000	29/32	289	492	1



Dosing of liquids is possible via a stopcock.

Cat. No.	Capacity (mL)	Neck	Tubulature (NS)	d (OD) (mm)	h (mm)	Pack Unit
24 702 44 05	500	24/29	19/26	86	164	10
24 702 54 01	1 000	29/32	19/26	107	200	10
24 702 63 03	2 000	29/32	19/26	134	249	1
24 702 73 08	5 000	45/40	29/32	182	320	1
24 702 86 04	10 000	60/46	29/32	228	398	1
24 702 91 03	20 000	60/46	29/32	289	492	1

### DURAN® Aspirator (levelling) Bottle

tubulated with standard ground joint, complete with standard ground stopcock and standard ground stopper

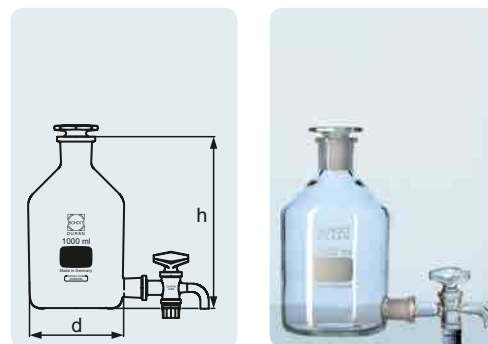

ISO 4796-3    Retrace Code    A 121 °C

Complete with screw connection cap, silicone seal and stopcock with PTFE spindle. Dosing of liquids is possible via a stopcock.

Cat. No.	Capacity (mL)	DIN Thread (GL)	d (OD) (mm)	h (mm)	Pack Unit
24 703 54 02	1 000	45	101	225	1
24 703 63 04	2 000	45	136	260	1
24 703 73 09	5 000	45	182	330	1
24 703 86 05	10 000	45	230	410	1

### DURAN® Aspirator (levelling) Bottle

neck with DIN thread GL 45, tubulatur with GL 32

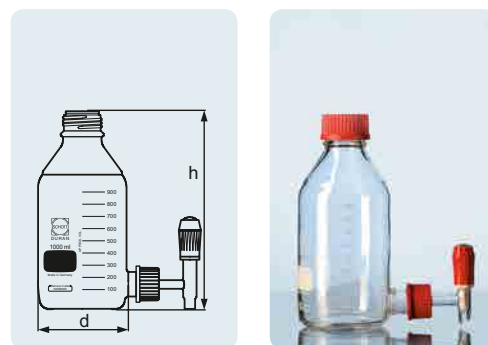

ISO 4796-3    Retrace Code    A 121 °C

## DURAN® Aspirator (levelling) Bottle

neck with DIN thread GLS 80®, tabulator with GL 32

Complete with screw connection cap, silicone seal and stopcock with PTFE spindle. Dosing of liquids is possible via a stopcock.

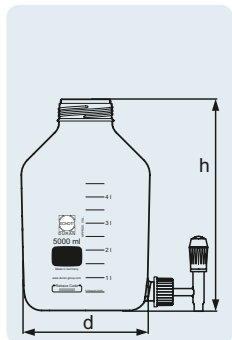

Cat. No.	Capacity (mL)	DIN Thread (GL)	d (OD) (mm)	h (mm)	Pack Unit
24 704 73 01	5 000	80	182	330	1



## Stopcock with Standard Ground Joint for Aspirator Bottle

Spare part for aspirator bottle.

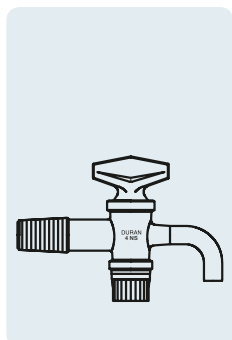

Cat. No.	Capacity (mL)	Neck	Pack Unit
24 148 03 07	500 – 2 000	19/26	1
24 148 04 01	5 000 – 20 000	29/32	1

## Stopcock for Aspirator Bottle

with PTFE spindle, for GL 32 screw thread

Cat. No.	Capacity (mL)	Hole (mm)	Remark	Pack Unit
24 147 03 06	1 000 + 2 000	6	suitable silicone sealing ring: cat.no. 29 236 10 04	1
24 147 04 09	5 000 + 10 000	8	suitable silicone sealing ring: cat. no. 29 236 12 01	1

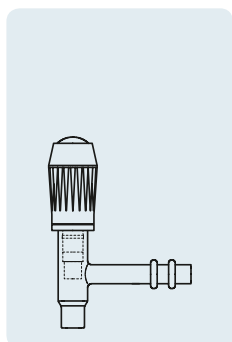

High form glass thread. A maximum usage temperature of + 100 °C is recommended. Thermal shock resistance 30 K. Hydrolytic class 3.

### Screw Cap Bottle Square from Soda-lime Glass

narrow neck, with thread, high form

Cat. No.	Capacity (mL)	Thread	d (OD) (mm)	h (mm)	Pack Unit
23 810 24 56	100	32	49	119	10
23 810 36 58	250	32	64	155	10
23 810 44 57	500	32	77	186	10
23 810 54 53	1 000	45	97	223	10

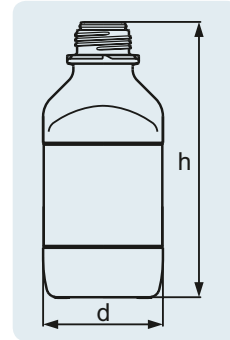

High form glass thread. A maximum usage temperature of + 100 °C is recommended. Thermal shock resistance 30 K. Hydrolytic class 3.

### Screw Cap Bottle Square, Amber from Soda-lime Glass

narrow neck, with thread, high form

Cat. No.	Capacity (mL)	Thread	d (OD) (mm)	h (mm)	Pack Unit
23 816 24 53	100	32	49	119	10
23 816 36 55	250	32	64	155	10
23 816 44 54	500	32	77	186	10
23 816 54 59	1 000	45	97	223	10

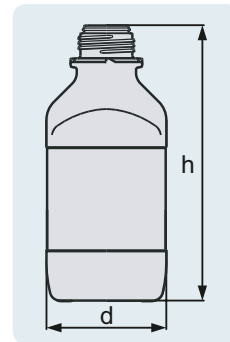

High form glass thread. A maximum usage temperature of + 100 °C is recommended. Thermal shock resistance 30 K. Hydrolytic class 3.

### Screw Cap Bottle Round, Amber from Soda-lime Glass

with thread, high form

Cat. No.	Capacity (mL)	Thread	d (OD) (mm)	h (mm)	Pack Unit
23 835 66 56	2 500	45	139	283	1

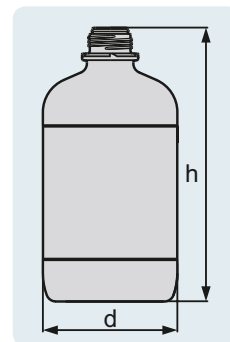

### Vented Screw Cap Narrow Neck

from PP, with valve, red, for soda-lime screw cap bottles

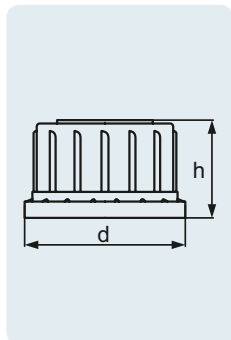

A  
121 °C

Tmax.  
140 °C

High form thread

Cat. No.	Thread	d (OD) (mm)	h (mm)	Pack Unit
29 302 19 09	32	45	32	10
29 302 28 02	45	60	35	10

### Tamper-Evident Screw Cap Narrow Neck

from PP (blue), for soda-lime screw cap bottle

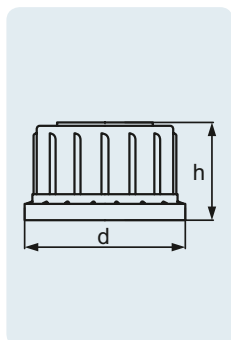

A  
121 °C

Tmax.  
140 °C

High form thread.

Cat. No.	Thread	d (OD) (mm)	h (mm)	Pack Unit
Temper evident screw cap				
29 301 19 08	32	45	32	10
29 301 28 01	45	60	35	10
Pouring ring				
29 251 19 04	32	45	32	10
29 251 28 06	45	60	35	10

### Screw Cap Bottle Square from Soda-lime Glass

wide neck, with thread, short form

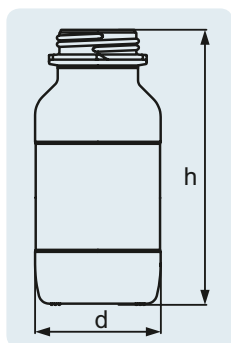

Short form glass thread. A maximum usage temperature of + 100 °C is recommended. Thermal shock resistance 30 K. Hydrolytic class 3.

Cat. No.	Capacity (mL)	Thread	d (OD) (mm)	h (mm)	Pack Unit
23 820 17 09	50	32	48	70	10
23 820 24 05	100	32	49	111	10
23 820 36 07	250	45	64	146	10
23 820 44 06	500	54	76	173	10
23 820 54 02	1 000	60	97	213	10



Short form glass thread. A maximum usage temperature of + 100 °C is recommended. Thermal shock resistance 30 K. Hydrolytic class 3.

### Screw Cap Bottle Square, Amber from Soda-lime Glass

wide neck, with thread, short form

Cat. No.	Capacity (mL)	Thread	d (OD) (mm)	h (mm)	Pack Unit
23 826 24 02	100	32	49	111	10
23 826 36 04	250	45	64	146	10
23 826 44 03	500	54	76	173	10
23 826 54 08	1000	54	97	213	10

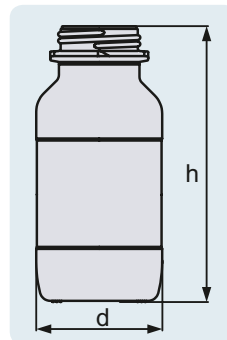

Short form thread.

### Tamper Evident Screw Cap Wide Neck

from PP (blue), for soda-lime square screw cap bottles

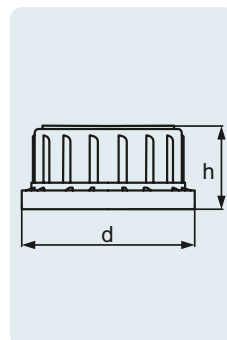

Cat. No.	Thread	d (OD) (mm)	h (mm)	Pack Unit
29 303 19 01	32	44	23	10
29 303 28 03	45	58	27	10
29 303 32 08	54	69	29	10
29 303 35 08	60	78	29	10



A  
121 °C

Tmax.  
140 °C

## DURAN® RANGE OF GL 25 / GL 32 / GL 45 BOTTLES

Product range		DURAN® ORIGINAL LABORATORY BOTTLE			DURAN® LABORATORY BOTTLE, AMBER		DURAN® LABORATORY BOTTLE, PROTECT			
Borosilicate 3.3. glass bottle body										
Caps <sup>5</sup>		Available with blue PP, or red PBT GL cap, or as a bottle only			Available with or without GL screw cap from PP		Available with or without GL screw cap from PP			
Temperature resistance		Bottle: -70 °C to +500 °C Cap, blue: -40 °C to +140 °C Cap, red: -45 °C bis +180 °C			Bottle: -70 °C to +500 °C Cap: -40 °C to +140 °C		Bottle: -30 °C to +135 °C Cap: -40 °C to +140 °C			
Main advantage		Tried and tested, classic DURAN® bottle suitable for multiple applications			<ul style="list-style-type: none"> <li>• UV protection up to approx. 500 nm wavelength</li> <li>• USP &lt;660&gt; and USP &lt;671&gt; (Spectral Transmission) compliant</li> </ul>		<ul style="list-style-type: none"> <li>• The coating provides scratch, leak<sup>4</sup> and splinter<sup>4</sup> protection</li> <li>• UV protection up to ca. 380 nm (ca. 500 nm Amber)</li> </ul>			
Color of bottle		clear			amber		clear		amber	
mL	GL thread	With blue screw Cap (PP)	With red screw Cap (PBT)	Without screw cap	With screw Cap (PP)	Without screw cap	With screw Cap (PP)	Without screw cap	With screw Cap (PP)	Without screw cap
10 <sup>1,2</sup>	25	21 801 08 51	-	21 801 08 02	21 806 08 56	21 806 08 07	-	21 805 08 06	-	-
25 <sup>1</sup>	25	21 801 14 53	-	21 801 14 04	21 806 14 58	21 806 14 09	-	10 926 76	-	21 806 14 33
50	32	21 801 17 53	-	21 801 17 04	21 806 17 58	21 806 17 09	-	10 926 77	-	21 806 17 33
100	45	21 801 24 58	21 801 24 17	21 801 24 09	21 806 24 54	21 806 24 05	21 805 24 53	21 805 24 04	-	21 806 24 38
150	45	21 801 29 55	-	21 801 29 06	21 806 29 51	21 806 29 02	21 805 29 59	21 805 29 01	-	-
250	45	21 801 36 51	21 801 36 19	21 801 36 02	21 806 36 56	21 806 36 07	21 805 36 55	21 805 36 06	-	21 806 36 31
500	45	21 801 44 59	21 801 44 18	21 801 44 01	21 806 44 55	21 806 44 06	21 805 44 54	21 805 44 05	-	21 806 44 39
750	45	21 801 51 55	-	21 801 51 06	21 806 51 51	21 806 51 02	21 805 51 59	21 805 51 01	-	-
1 000	45	21 801 54 55	21 801 54 14	21 801 54 06	21 806 54 51	21 806 54 02	21 805 54 59	21 805 54 01	-	21 806 54 35
2 000	45	21 801 63 57	21 801 63 16	21 801 63 08	21 806 63 53	21 806 63 04	21 805 63 52	21 805 63 03	-	21 806 63 37
3 500	45	21 801 69 57	-	21 801 69 08	21 806 69 53	21 806 69 04	21 805 69 52	21 805 69 03	-	-
5 000	45	21 801 73 53	21 801 73 12	21 801 73 04	21 806 73 58	21 806 73 09	21 805 73 57	21 805 73 08	-	21 806 73 33
10 000	45	21 801 86 58	21 801 86 17	21 801 86 09	21 806 86 54	21 806 86 05	-	21 805 86 04	-	-
15 000	45	21 801 88 55	-	21 801 88 06	-	21 806 88 02	-	21 805 88 01	-	-
20 000	45	21 801 91 57	-	21 801 91 08	-	21 806 91 04	-	21 805 91 03	-	-
25 000	45	21 801 92 51	-	-	-	-	-	-	-	-

<sup>1</sup> With specially shaped glass lip for improved pouring out, so a separate pouring ring from PP is not required.

<sup>2</sup> Acceptance within ISO 4796-1:2013 standard has been requested.

<sup>3</sup> Bottle with plastic coating available on request.





<sup>4</sup> Only applies to bottles 5 000 mL and less.





<sup>5</sup> All these bottles are compatible with the full range of DURAN® GL caps, including chemically resistant, venting membrane, temper-evident, pharmaceutical grade, and connection system caps.

<sup>6</sup> Only available with GL 32 thread.

DURAN® LABORATORY BOTTLE, PRESSURE PLUS+			DURAN® PREMIUM BOTTLE		DURAN® LABORATORY BOTTLE, SQUARE	
Supplied without screw cap			Available with or without GL 45 Premium cap from PFA		Available with or without GL screw cap from PP	
Bottle: -70 °C to +140 °C			Bottle: -70 °C to +500 °C Cap: -196 °C to +200 °C		Bottle: -70 °C to +500 °C Cap: -40 °C to +140 °C	
<ul style="list-style-type: none"> <li>Vacuum and pressure resistance -1 to +1.5 bar</li> <li>Suitable for HPLC applications</li> <li>UV protection up to ca. 500 nm (Amber)</li> </ul>			USP/FDA Conformity of bottle, screw cap and pouring ring		<ul style="list-style-type: none"> <li>Space saving shape</li> <li>Ideal for storage and transport</li> </ul>	
clear	clear, protect	amber	clear		clear	
Without screw cap	Without screw cap	Without screw cap	With premium screw cap PFA	Without premium screw cap	With screw Cap (PP)	Without screw cap
-	-	-	-	-	-	-
-	-	-	-	-	-	-
-	-	-	-	-	-	-
21 810 24 06	21 815 24 02	21 816 24 03	11 270 75	11 270 79	21 820 24 53 <sup>6</sup>	21 820 24 04 <sup>6</sup>
-	-	-	-	-	-	-
10 922 34	11 759 25	10 943 67 <sup>3</sup>	11 270 76	-	21 820 36 55	10 088 34
10 922 35	11 759 26	10 943 68 <sup>3</sup>	11 270 77	-	21 820 44 54	10 088 42
-	-	-	-	-	-	-
21 810 54 03	21 815 54 08	21 816 54 09 <sup>3</sup>	11 270 78	11 279 76	21 820 54 59	10 088 43
-	-	-	-	-	-	-
-	-	-	-	-	-	-
-	-	-	-	-	-	-
-	-	-	-	-	-	-
-	-	-	-	-	-	-
-	-	-	-	-	-	-
-	-	-	-	-	-	-

## DURAN® RANGE OF GL THREADED SCREW CAPS AND CLOSURES

Name	DURAN® Original GL Laboratory Bottle Cap		DURAN® GL Membrane Vented Cap		DURAN® GL Tamper Evident Cap		DURAN® GL Tamper Evident Cap	
								
Description	Excellent general purpose cap. Autoclavable. Good chemical resistance. Colour choice.		Venting membrane. Safe autoclaving. Sterile storage of liquids.		Tamper evident cap. Liner less sealing. Autoclavable.		Tamper evident cap. Reliable liner sealing. Autoclavable.	
Materials of Construction	Polypropylene + colour		Polypropylene + colour + PTFE membrane		Polypropylene + colour		Polypropylene + colour (PTFE / silicone cap liner)	
Available Colours	Blue / Yellow / Green or Grey		Blue		Blue / red		Blue / yellow	
Type of Seal	Plug seal / Liner less		Plug seal / Liner less		Plug seal / Liner less		Cap liner	
Maximum Temperature	+140 °C		+140 °C		+140 °C		+140 °C	
Minimum Temperature	-40 °C		-40 °C		-40 °C		-40 °C	
Available GL Thread Sizes (acc. DIN 168-1 (1998-04))	25, 32 and 45		25, 32 and 45		45		45	
Safe for Food Contact (E.g. FDA & EU)	Yes		Yes		Yes		Yes	
Pharmacopoeia Compliant (USP / EP)	No		No		No		No	
Lot Specific Retrace Code	No		No		No		No	
Matching Pouring Ring	Yes, GL 32 and GL 45 only Polypropylene + colour (Blue / Yellow / Green or Grey)		Yes, GL 45 only Polypropylene + colour (Blue)		Yes, GL 45 only Polypropylene + colour (Blue)		Yes, GL 45 only Polypropylene + colour (Blue)	
GL 14	-		-		-		-	
GL 18	-		-		-		-	
GL 25	● 29 239 13 07		● 29 118 13 07		-		-	
GL 32	Cap	Pouring ring	Cap	Pouring ring	-		-	
	● 29 239 19 07	● 29 242 19 07	● 29 118 19 07	● 29 242 19 07	-		-	
GL 45	Cap	Pouring ring	Cap	Pouring ring	Cap	Pouring ring	Cap	Pouring ring
	● 29 239 28 09	● 29 242 28 09	● 29 118 28 09	● 29 242 28 09	● 10 175 26	● 29 242 28 09	● 11 558 86	● 29 242 28 09
	● 29 338 28 02	● 10 899 17						
	● 29 338 28 68	● 10 899 11						
	● 29 338 28 84	● 10 899 14						
GL 56	-		○ 29 118 56 09		-		-	

	DURAN® GL 45 YOUTILITY Cap		DURAN® TILT GL 56 Cap		DURAN® GL PBT Cap		DURAN® GL PBT Open Topped (Aperture) Cap		DURAN® GL PREMIUM Cap	
										
	Ergonomic shape. Autoclavable. Faster thread GL 45 compatible.		Ergonomic shape. Autoclavable.		High temperature and chemical resistance. Autoclavable. Reliable sealing.		Excellent temperature and chemical resistance. Autoclavable. Open topped for septa or connectors.		High purity and performance. Autoclavable. Uncoloured for biopharmaceutical processing.	
	Polypropylene + colour		Polypropylene + colour		Polybutylene terephthalate (PBT) + 30% glass fibre + colour (PTFE / silicone cap liner)		Polybutylene terephthalate (PBT) + 30% glass fibre + colour		Uncoloured Perfluoroalkoxy alkanes (PFA / TpCH260) (PTFE / silicone cap liner)	
	Cyan		White		Red		Red		Translucent	
	Plug seal / Liner less		Plug seal / Liner less		Cap liner		Not applicable – open topped		Cap liner	
	+140 °C		+140 °C		+180 °C		+180 °C		+200 °C	
	-40 °C		-40 °C		-45 °C		-45 °C		-196 °C	
	45		56		14, 18, 25, 32 and 45		14, 18, 25, 32 and 45		25 and 45	
	Yes		Yes		Yes		Yes		Yes	
	No		No		No (Cap liner – Yes EP)		No		Yes (Cap body – USP <87> Class VI (120 °C)) (Cap liner – EP)	
	Yes		Yes		No		No		Yes	
	Yes, GL 45 only Polypropylene + colour (Cyan)		None		Yes, for GL 32 and GL 45 only red ETFE		Yes, for GL 32 and GL 45 only red ETFE		Yes, for GL 45 only PFA Translucent	
	-		-		● 29 240 08 06		● 29 227 05 08		-	
	-		-		● 29 240 11 08		● 29 227 06 02		-	
	-		-		● 29 240 13 05		● 29 227 09 02		● 11 296 00	
	-		-		Cap		Pouring ring		-	
	-		-		● 29 240 19 05		● 29 244 19 09		-	
	Cap		-		Cap		Pouring ring		Cap	
	● 29 229 28 02		-		● 29 240 28 07		● 29 244 28 02		● 29 227 08 08	
	● 29 241 28 08		-		-		-		● 29 227 10 07	
	-		○ 29 229 56 02		-		-		● 10 886 79	
	-		-		-		-		● 10 886 78	
	-		-		-		-		-	

## DURAN® RANGE OF GLS 80® BOTTLES AND CAPS

Product range		DURAN® GLS 80® WIDE MOUTH LABORATORY BOTTLE		DURAN® GLS 80® WIDE MOUTH LABORATORY BOTTLE, AMBER		DURAN® GLS 80® WIDE MOUTH LABORATORY BOTTLE, PROTECT			
Borosilicate 3.3. glass bottle body									
Caps <sup>1</sup>		Available with or without GLS 80° screw cap from PP		Available with or without GLS 80° screw cap from PP		Available with or without GLS 80° screw cap from PP			
Temperature resistance		Bottle: -70 °C to +500 °C Cap: -40 °C to +140 °C		Bottle: -70 °C to +500 °C Cap: -40 °C to +140 °C		Bottle: -30 °C to +135 °C Cap: -40 °C to +140 °C			
Main advantage		<ul style="list-style-type: none"> <li>• Tried and tested, DURAN® glass</li> <li>• Wide mouth enables easy access</li> </ul>		<ul style="list-style-type: none"> <li>• USP &lt;660&gt; and USP &lt;671&gt; (Spectral Transmission) compliant</li> <li>• UV protection up to ca. 500 nm</li> </ul>		<ul style="list-style-type: none"> <li>• The coating provides scratch, leak and splinter protection<sup>2</sup></li> <li>• UV protection up to ca. 380 nm (ca. 500 nm Amber)</li> </ul>			
Colour		clear		amber		clear		amber	
mL	GLS thread	With screw cap (PP)	Without screw cap	With screw cap (PP)	Without screw cap	With screw cap (PP)	Without screw cap	With screw cap (PP)	Without screw cap
250	80	21 860 36 56	21 860 36 07	21 866 36 53	21 866 36 04	21 865 36 52	21 865 36 03	-	-
500	80	11 126 27	11 783 92	11 601 46	11 784 29	11 601 52	-	11 673 08	21 866 44 36
1000	80	11 127 13	11 784 24	11 601 47	11 784 30	11 601 63	-	11 673 09	21 866 54 32
2000	80	11 127 15	11 784 25	11 601 48	11 784 31	11 601 64	-	-	21 866 63 34
3500	80	21 860 69 53	21 860 69 04	21 866 69 59	21 866 69 01	21 865 69 53	21 865 69 09	-	-
5000	80	11 139 49	11 784 26	11 601 49	11 784 32	11 601 65	-	-	21 866 73 39
10000	80	11 139 50	11 784 27	11 601 50	11 784 33	-	-	-	-
20000	80	11 139 51	11 784 28	11 601 51	11 784 34	-	-	-	-

<sup>1</sup> All these bottles are compatible with the full range of DURAN® GLS caps, including chemically resistant, venting membrane, pharmaceutical grade, and connection system caps.

<sup>2</sup> For the bottle sizes from 250 – 5 000 mL

	DURAN® GLS 80® QUICK RELEASE CLOSURE FROM PP		DURAN® GLS 80® QUICK RELEASE CLOSURE WITH CAP LINER (PSU COMPOUND)			DURAN® GLS 80® MEMBRANE VENTED SCREW CAP FROM PP
						
	A matching PP pouring ring is available		A matching PTFE pouring ring is available			Use with either PP or PTFE pouring ring
	-40 °C to +140 °C		-45 °C to +180 °C			-40 °C to +140 °C
	Permits opening and closing of the DURAN® GLS 80® bottle with only a three-quarter turn		The PSU material with PTFE coated liners offers improved chemical, thermal and mechanical properties			Ideal for autoclave application, membrane permits pressure equalisation
	blue		white			blue
	Screw cap	Pouring ring	Screw cap	Pouring ring	Replacement cap liner	Screw cap
	11 127 16	11 601 66	11 658 88	11 673 07	11 529 21	29 118 91 05



250 ml  
Made in Germany

SCHOTT  
DURAN