

# Molding Innovation

Leadership In True 3D CAE Technology

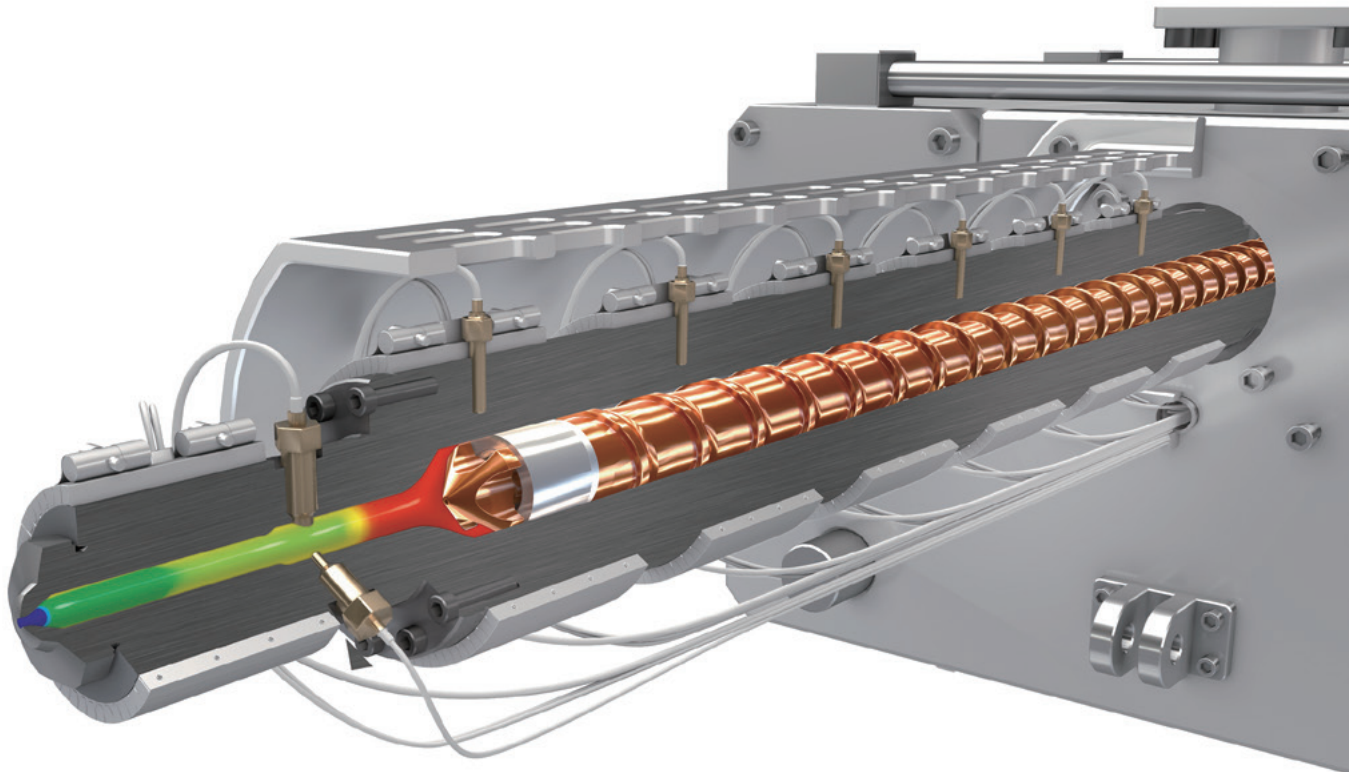

# Key to Your Core Competitiveness

## Cost Saving for Your Business

Moldex3D CAE Software provides the true 3D simulation and visualization technology you need if you are fed up with countless trial-and-errors and want to save time, energy, and money more efficiently during the mold-making process.

- Shorten time to market and increase revenue and ROI.
- Reduce the tool trials time and its cost of electricity and manpower.
- Increase margin rate with minimized cycle time and manufacturing cost.
- Reduce product scrap rate and extend mold life.

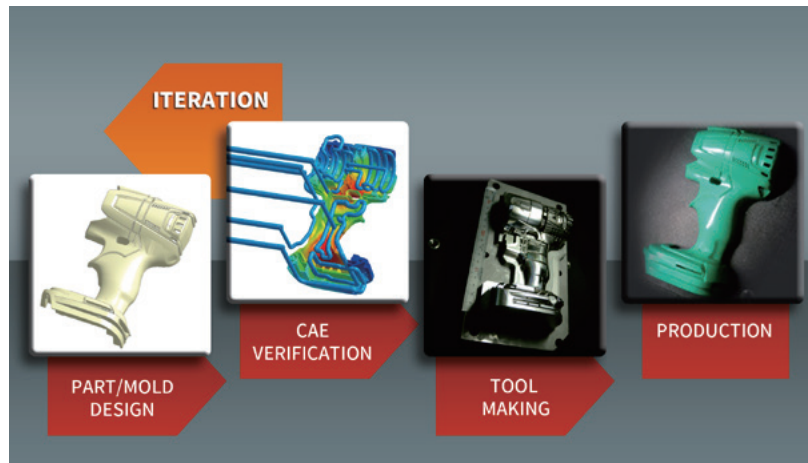

## Optimize Part/Mold Design Process

### Intuitive User Interface to Streamline Simulation Workflows

- Single platform for all powerful Moldex3D simulation functions.
- Integrated workflow through out to ensure modeling accuracy.
- High quality render performance for upgraded usability.
- Convenient result inspection and comparison functions.
- A variety of Pre/Post tools and customized report.

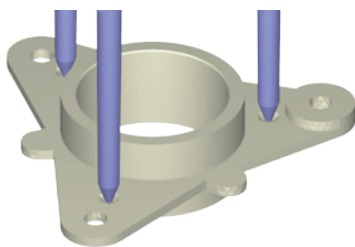

Model Design

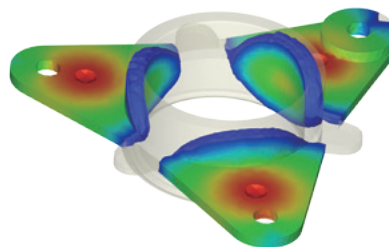

Powerful Simulation

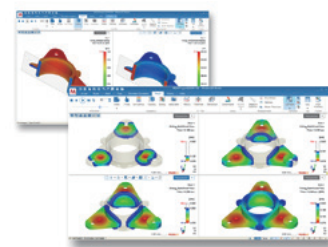

Convenient Result Display

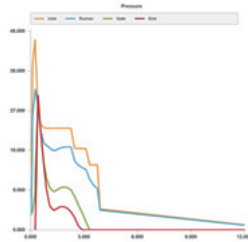

Variety of XY Plot

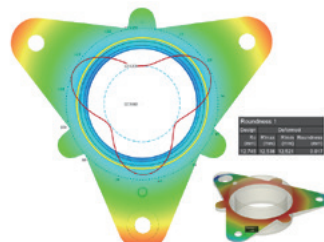

Measurement Tools



Customized Report

# Validate and Optimize with Plastics Injection Molding Simulation

Moldex3D is the world-leading CAE product for the plastic injection molding industry. With the best-in-class analysis technology, Moldex3D can help you carry out in-depth simulation of the most extensive range of injection molding processes and optimize product designs and manufacturability. Also, its high compatibility and adaptability have provided users with an instant connection to mainstream CAD systems, generating a flexible simulation-driven design platform.

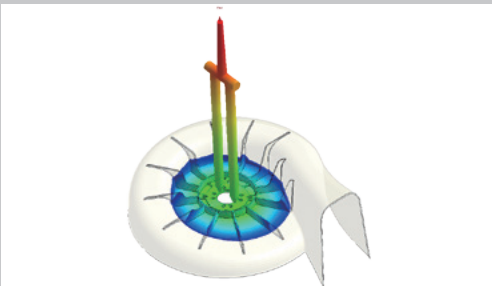

## Flow

- Predict melt front and flow pattern.
- Optimize gating locations and design.
- Diagnose common manufacturing issues (weld line, flow imbalance, air trap, hesitation, short shot, etc.).

## Issue Diagnosis for Your Product

Predict upfront most of the common manufacturing problems, such as short shot, flow imbalance, air trap, or hesitation. It greatly improves part quality, structure, and appearance.



Weld Line



Flow Imbalance

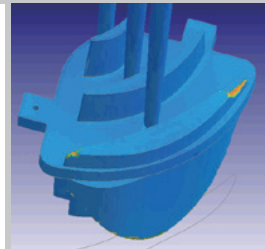

Air Trap

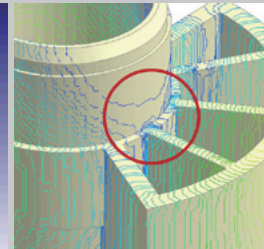

Hesitation

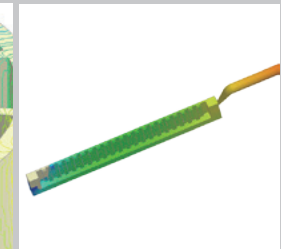

Short Shot

## Pack

- Evaluate gate-freeze time.
- Avoid sink mark or flash.
- Optimize packing profile.

## Cool

- Improve cooling efficiency.
- Reduce cycle time.
- Predict hot spots.

## Warp

- Predict final part shape.
- Identify warpage causes.
- Calculate residual stress.

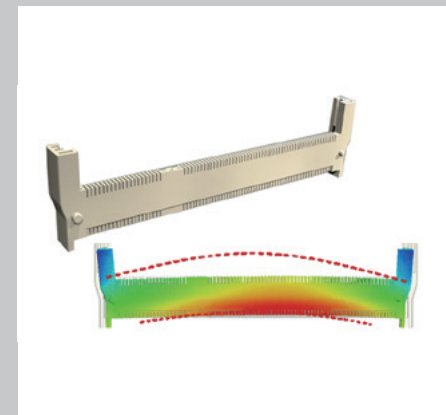
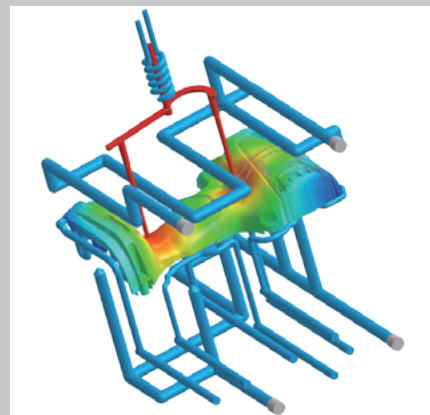
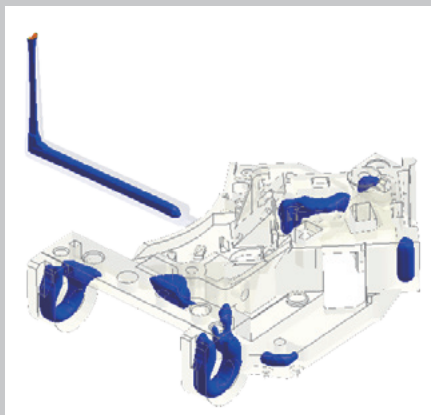

# Cooling System Design and Thermal Management

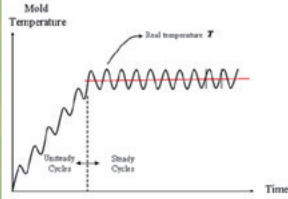
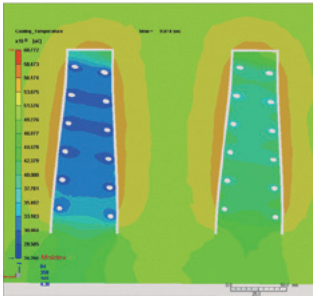

## Transient Cool

- Support various dynamic variotherm technologies, including Heat & Cool™, Induction Heating Molding (IHM), Electricity Heating Mold (E-Mold), etc.
- Utilize rapid temperature-changing molding process to increase melt fluidity in the filling stage.

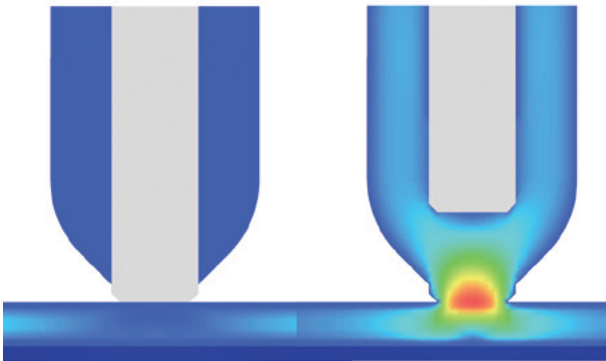

## Advanced Hot Runner (AHR)

- Visualize temperature distributions over time in hot runners and moldbase.
- Predict problems, such as non-uniform melt temperature, unbalanced filling, etc.
- Support quick, steady analysis for complex hot runner layout design.
- Support pin movement control simulation by flow front location.

## 3D Coolant CFD

- Simulate coolant flow in 3D cooling channels to guarantee cooling efficiency.
- Visualize the streamline direction and predict dead spot.
- Optimize cooling system design and achieve cycle time reduction.

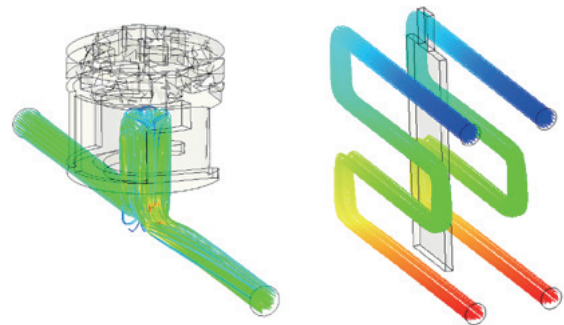

## Moldex3D Conformal Cooling

- Allow conformal cooling modeling with the combination of different line and geometry defined components.
- Provide wizard interface for a fast and intuitive workflow to build complex cooling system.

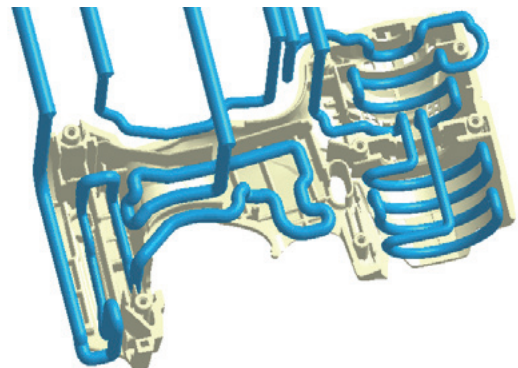

# Multiple-Material Product and Design

## Multi-Component Molding (MCM)

- Simulate Insert and Sequential Shot Molding.
- Detect potential re-melt issue.
- Predict warpage and cooling with different materials.
- Evaluate the impact by thermal and fiber condition in insert component from another shot.

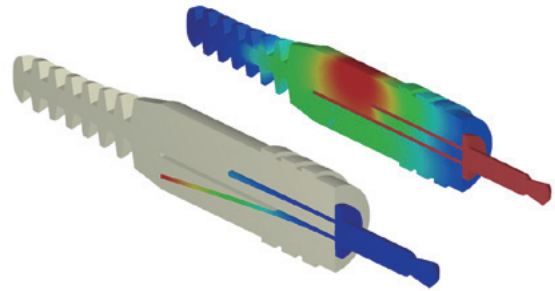

## In-Mold Decoration (IMD)

- Enable easy IMD film modeling workflow with minimum human effort.
- Provide wash-out index to better predict the wash-off ink decoration of the film.



# Plastic Molding Simulation Transformation

## Stress

- Predict stress and displacement distributions of parts and part inserts.
- Evaluate displacements of plastics under certain external loadings.
- Support FSI (Fluid-structure interaction) calculation.
- Predict annealing with Viscoelasticity.

## Viscoelasticity (VE)

- Analyze the viscous and elastic properties of polymeric materials.
- Calculate flow-induced residual stress, warpage, and optical properties (with Optics module).
- Observe advanced flow-fiber induced special molding phenomenon.

## Optics

- Predict flow- or thermally-induced birefringence, retardation, fringed orders, and fringed patterns.
- Integrate with CODE V by providing non-uniform refractive index prediction and deformed shape.

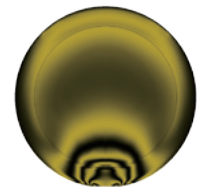

# DOE & Optimization

## Expert

- Manage analysis variation and provide graphical summaries automatically.
- Evaluate the optimal process conditions, such as injection velocity, packing time, cooling time, or mold temperature.

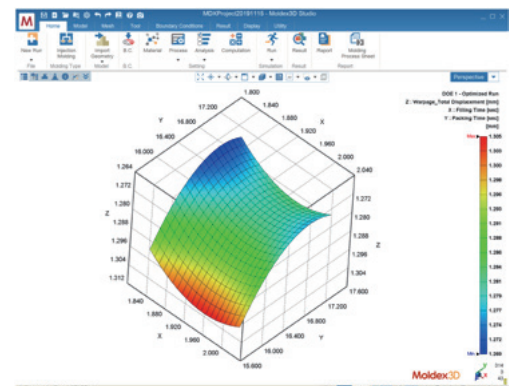

# Lightweight Composite Products

## Fiber

- Visualize fiber orientation, length, and concentration inside fiber-reinforced plastics.
- Evaluate the filler effect to mechanical properties and final shrinkage.
- Optimize process conditions to enhance the part strength.
- Support short, long, flat fiber and flake orientation simulation.

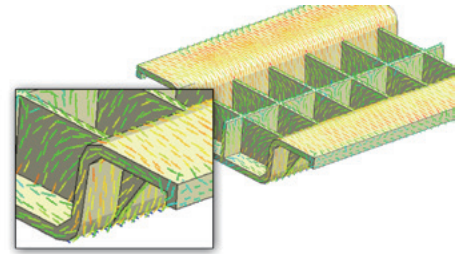

## FEA/Micromechanics Interface

- Export fiber orientation, material anisotropy, residual stresses, and molding pressure to structural software.
- Validate the structural performance of products and mold sustainability.

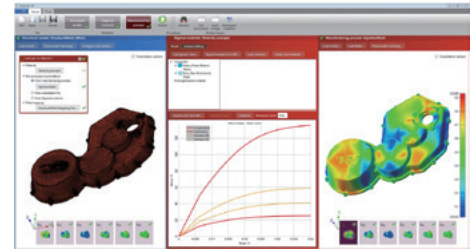

## Moldex3D Digimat-RP

- Bridge manufacturing process and FEA analysis.
- Predict the mechanical behaviors with nonlinear material modeling technology for reinforced plastic.
- Define material properties and criteria of failure properties for reinforced plastic.
- Support automatic reverse engineering for material model generation based on experiment data.

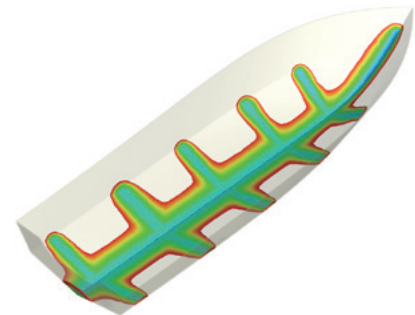

## Resin Transfer Molding (RTM)

- Control resin infusion by pressure or flow rate.
- Capture cure reaction trend during molding through viscosity and kinetics models.

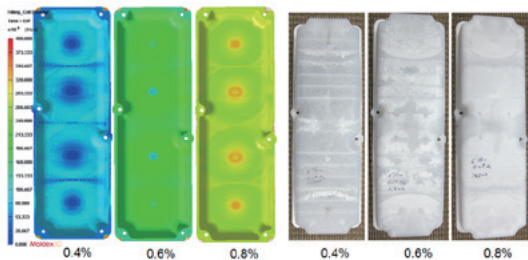

## Foam Injection Molding (FIM)

- Visualize the filling behavior of the polymer-gas solution into the cavity.
- Visualize bubble density and size considering the bubble nucleation and growth.
- Evaluate the surface quality, weight reduction, tonnage reduction, shrinkage reduction, etc.
- Support CBA material simulation as an initial gas concentration option for thermoplastic analysis.

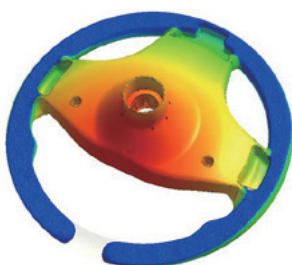

## PU Chemical Foaming Molding (CFM)

- Provide foaming kinetics for different by-products in chemical foaming process.
- Optimize for a desired volume-to-weight ratio of the product.

# Molding Innovation

## Reaction Injection Molding (RIM)

- Simulate thermoset injection molding.
- Simulate cavity filling, curing, part warpage, fiber orientation, multi-component molding, etc.

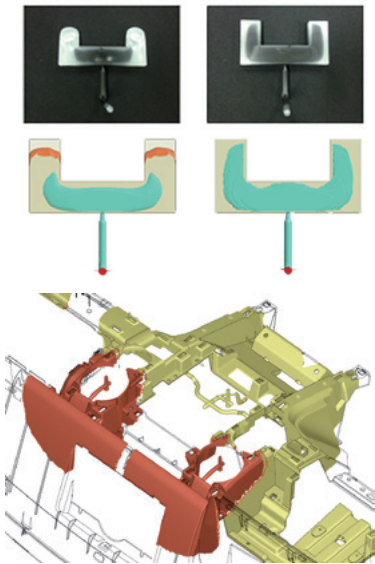

## Co-Injection Molding (CoIM)

- Visualize the flow behaviors of skin and core materials.
- Optimize geometry thickness and process conditions based on core breakthrough prediction.
- Consider temperature imbalance and pressure resistance variations of skin layer and center core.

## Bi-Injection Molding (BiIM)

- Define independent melt entrances and filling/packing parameters for different materials.
- Visualize the melt front time for each melt entrance in the filling stage.
- Predict weld line through melt front advancement.



## Gas/Water-Assisted Injection Molding (GAIM/WAIM)

- Specify the gas/fluid injected from single or multiple gas entrances or from the melt entrance.
- Optimize gas/fluid channel designs and locations of gas/fluid entrances.
- Visualize the skin thickness and core-out ratio distributions and predict corner effect and blow through.

## Compression Molding (CM)

- Visualize pressure distribution, volume shrinkage, residual stress distribution, fiber orientation, etc.
- Predict potential molding defects, such as flashing.

## Injection Compression Molding (ICM)

- Visualize property changes in the compression molding process over time.
- Calculate residual stress and evaluate process designs.

## Powder Injection Molding (PIM)

- Visualize flow behaviors of the feedstock.
- Predict black line due to phase separation of powder and binder (non-uniform powder concentration).

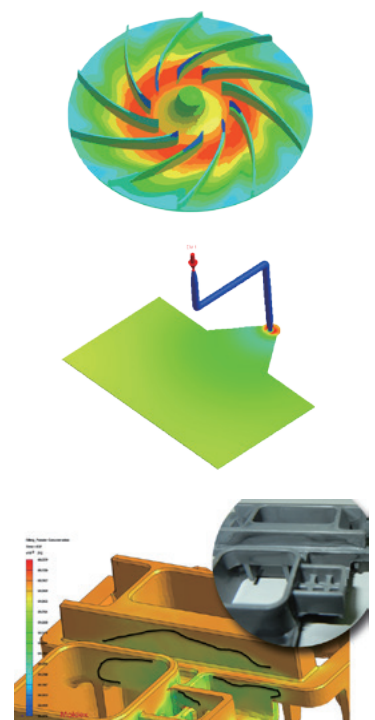

## High-Performance Computing (HPC)

---

### Parallel Processing (PP)

Speed up analysis with options of utilizing the strength of multi-core, multi-CPU, and multi-PC cluster.

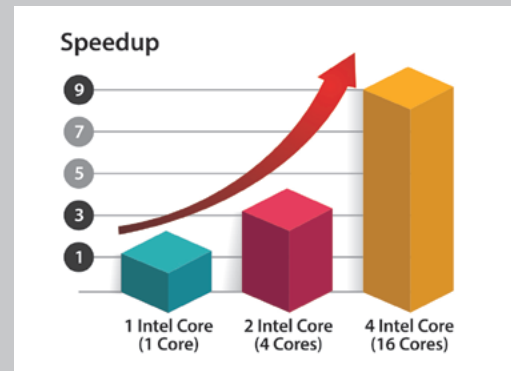

### Cloud Extension

- Provide scalable license seats for fluctuating demands.
- Support full Moldex3D simulation capabilities.
- Offer a 16-core computing node for one job.

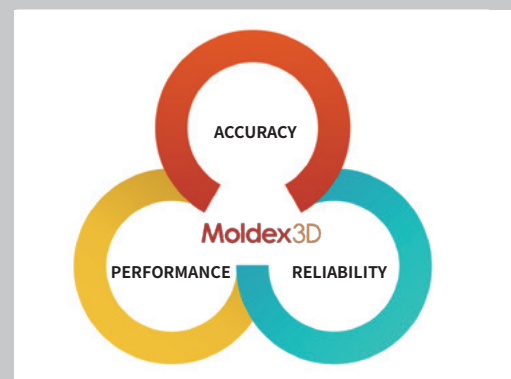

## CAD Interoperability

---

### SYNC

- Integrated with PTC® Creo®, NX, and SOLIDWORKS®.
- Provide the automatic mesh engine and intelligent wizards for CAE analysis and help to build a complete injection molding system in CAD environment.
- Synchronize design changes with simulations to effectively optimize the product designs.
- Enable CAD users to quickly validate part designs directly in familiar CAD/CAM environments.

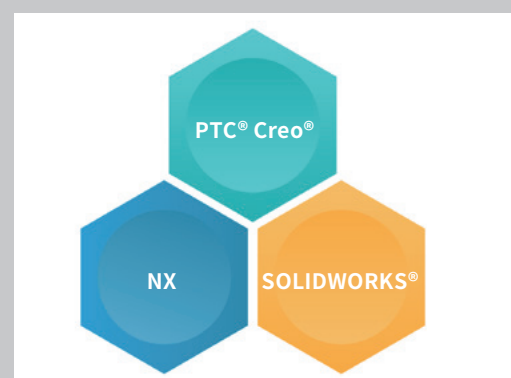

### API

- Enable users the automatic workflow via the pre/post-processing API.
- Integrate with CAD and structural analysis software.



## Boost Work Efficiency in Pre-processing

### High Resolution 3D Mesh Technology (BLM)

- Enable automatic mesh generation, especially for complicated 3D geometry, with less complex and faster workflow.
- Mixed type to construct runner system with combination of curve and geometry runner/gate.
- Support non-matching technology for part insert and moldbase.
- Support tetra elements and Boundary Layer Mesh (BLM).

### Auto 3D Meshing Engine (eDesign)

Support auto mesh generation for saving time and variant level of mesh generation with intelligent wizards.

### Hybrid Mesh Technology

- Create mesh manually for the most customized purpose.
- Increase mesh resolution significantly with acceptable element count.
- Control uniform or biasing mesh pattern and element layer count in thickness direction by users.
- Support tetra, hexahedral, prism, and pyramid elements.

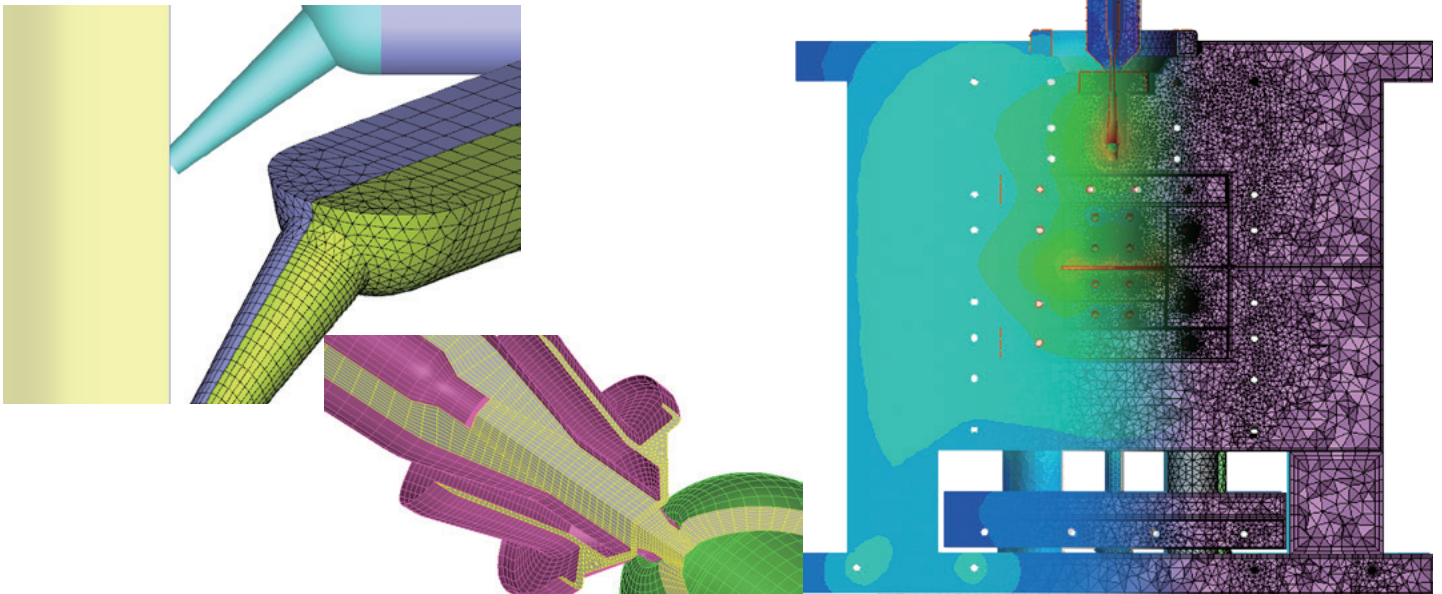

## Integrated Geometry Healing Tool

### Moldex3D CADdoctor

- Enable multi-CAD data exchange between Moldex3D preprocessing and multi-CAD platform.
- Fix the defects of part and simplify the complicated geometry structure with high-quality surfaces and entities for better BLM generation.

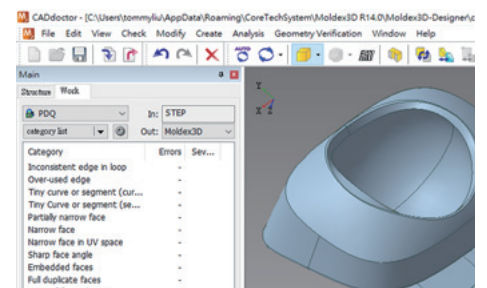

# Product Portfolio and Features

## Standard Injection Molding

● Essential features contained | ○ Optional features

	Professional Basic	eDesign	Professional	Advanced
<b>Solver Capabilities</b>				
Simultaneous Filling Analysis (max.)	1	1	1	3
Parallel Processing (PP)	4	4	8	12
Cloud Extension	●	●	●	●
Material Database <sup>1</sup>	●	●	●	●
Thermoplastic Injection Molding (IM)	●	●	●	●
Reaction Injection Molding (RIM)	●	●	●	●
<b>Simulation Capabilities</b>				
Filling	●	●	●	●
Surface Defect Prediction	●	●	●	●
Venting Design	●	●	●	●
Gate Design	●	●	●	●
Cold & Hot Runners	●	●	●	●
Runner Balancing	●	●	●	●
Machine Response <sup>2</sup>	○	○	○	○
Packing		●	●	●
Cooling		●	●	●
Transient Mold Cooling or Heating		●	●	●
Conformal Cooling		●	●	●
3D Coolant CFD		○	●	●
Rapid Temperature Cycling		●	●	●
Induction Heating		●	●	●
Heating Elements		●	●	●
Warpage		●	●	●
Insert Molding	●	●	●	●
Multi-shot Sequential Molding		●	●	●
<b>Mesh Technology</b>				
Boundary Layer Mesh (BLM)	●		●	●
eDesign	●	●	●	●
Solid (Hexa, Prism, Pyramid, Hybrid)				●
Shell (2.5D Mesh)				●

## System Requirements

<b>Platform</b>	
Windows	Windows 10, 8, 7, Server 2016, Server 2012 R2
<b>Hardware</b>	
Minimum	Intel® Core i7 Sandy Bridge series, 16 GB RAM, and at least 1 TB free space
Recommended	Intel Xeon Platinum 8000 series processor, at least 64 GB RAM & 4 TB free space HDD, NVIDIA Quadro & AMD Radeon series graphic card and 1920 x 1080 screen resolution

## Solution Add-on

● Essential features contained | ○ Optional features

	Professional Basic	eDesign	Professional	Advanced
<b>CAD Interoperability</b>				
SYNC <sup>3</sup>	○	○	○	○
Moldex3D CADdoctor	○	○	○	○
<b>Fiber Reinforced Plastics</b>				
Fiber <sup>4</sup>	○	○	○	○
FEA Interface <sup>5</sup>	○	○	○	○
Micromechanics Interface <sup>6</sup>	○	○	○	○
Moldex3D Digimat-RP	○	○	○	○
<b>Flow-Structure Interaction</b>				
In-Mold Decoration (IMD)			○	○
Stress		○	○	○
Viscoelasticity (VE)		○	○	○
Optics				○
<b>Design Management and Optimization</b>				
Expert (DOE)		○	○	○
Advanced Hot Runner (AHR)		○	○	○
API	○	○	○	○
<b>Special Molding Processes</b>				
Powder Injection Molding (PIM)	○	○	○	○
Foam Injection Molding (FIM)		○	○	○
Gas-Assisted Injection Molding (GAIM)			○	○
Water-Assisted Injection Molding (WAIM)			○	○
Co-Injection Molding (CoIM)			○	○
Bi-Injection Molding (BiIM)			○	○
PU Chemical Foaming Molding (CFM)			○	○
Compression Molding (CM)				○
Injection Compression Molding (ICM)				○
Resin Transfer Molding (RTM)				○

1. Database: Thermoplastics materials, thermoset materials, molding materials, coolant materials, and mold materials.
2. Machine Response function requires the machine file received from Machine Characterization service.
3. Moldex3D SYNC supports PTC® Creo®, NX, and SOLIDWORKS®.
4. Flat Fiber and Flow-Fiber Coupling function require additional license EnhancedFiber.
5. Moldex3D FEA Interface supports Abaqus, ANSYS, MSC.Nastran, NXNastran, LS-DYNA, MSC.Marc, and OptiStruct.
6. Moldex3D Micromechanics Interface supports Digimat and CONVERSE.

**Moldex3D**



CoreTech System Co., Ltd.

[mail@moldex3d.com](mailto:mail@moldex3d.com)

For more information, please visit [www.moldex3d.com](http://www.moldex3d.com)

Copyright © 2020 Moldex3D. All rights reserved.

DMFull2020EN20-1