

Portable Speakers

iNSPIRE iP82

2 Way 8" Full Range Loudspeaker for
Portable PA Applications

- 2 way full range loudspeaker for portable PA applications
- 150 Watts continuous, 600 Watts peak power
- Satellite speaker for use with iP subwoofers
- 8" low frequency driver with low mass voice coil for improved transient response
- High temperature dome 1" compression driver
- Low distortion waveguide provides 70° H x 70° V dispersion
- 15 mm (5/8") birch plywood enclosure with hard wearing semi matt black paint finish
- Rugged powder coated perforated steel mesh grille
- Integral 35 mm pole mount and handle
- Neutrik speakON* NL4 connector for reliable long life operation
- 3-Year Warranty Program*
- Designed and engineered in England



The 2-way full range iP82 is a passive 600-Watt 8" loudspeaker system ideally suited for a wide range of portable speech and music sound reinforcement applications. The iP82 provides optimal performance as a FOH satellite speaker when used with our iP12B and iP15B active subwoofers. The versatile iP82 is also an exceptional choice for sidefill, stage lip, balcony and delay line applications – and is perfect for small to medium-sized performance venues, such as house of worship, boardroom, nightclubs, and much more.



Custom-Engineered Drivers

Our speakers are designed specifically for each application – it's what sets us apart from the competition. When you buy a **TURBOSOUND** speaker system, you can rest assured that the speakers inside have been engineered to perform flawlessly in conjunction with every other element for truly professional results. The iP82 loudspeaker features an 8" low frequency driver with a low mass voice coil for improved transient response, and a high temperature dome 1" compression driver mounted on a low distortion 70° horizontal by 70° vertical dispersion waveguide. All drivers are matched with an internal passive crossover network in a reflex-loaded enclosure, which ensures truly professional results.

*All third-party trademarks are the property of their respective owners. Their use neither constitutes a claim of the trademark nor affiliation of the trademark owners with MUSIC Group. Product names are mentioned solely as a reference for compatibility, effects and/or components. Warranty details can be found at music-group.com.

Portable Speakers

iNSPIRE iP82

2 Way 8" Full Range Loudspeaker for
Portable PA Applications

Solid Construction

Finished in a highly durable semi matt black paint, the cabinet is constructed from 15 mm (5/8") birch plywood – and includes a rugged powder coated perforated steel mesh grille backed with reticulated foam. The iP82 also features a 35 mm socket for pole mounting atop iP15B / iP12B active subwoofers, or on industry-standard loudspeaker stands.

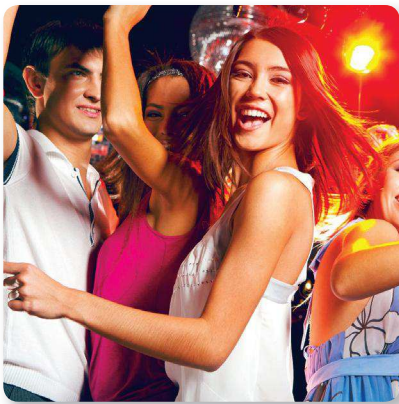

Stunning Performance – Superb Value

The iNSPIRE iP82 portable PA loudspeaker stands head and shoulders above the rest of the pack and delivers exceptional performance, even when pushed to the limit. Built rugged to withstand the rigors of the road, the versatile iP82's custom-designed transducers handle up to 600 Watts of input power and is ideal for portable applications – at a price unheard of in this class.

Experience the iP82 at your local dealer today, or get yours online today – and let **TURBOSOUND** take your performance to the next level!

You Are Covered

We always strive to provide the best possible Customer Experience. Our products are made in our own **MUSIC Group** factory using state-of-the-art automation, enhanced production workflows and quality assurance labs with the most sophisticated test equipment available in the world. As a result, we have one of the lowest product failure rates in the industry, and we confidently back it up with a generous **3-Year Warranty** program.



iNSPIRE iP82

2 Way 8" Full Range Loudspeaker for
Portable PA Applications

Frequency Response Sensitivity 1 W / 1 m

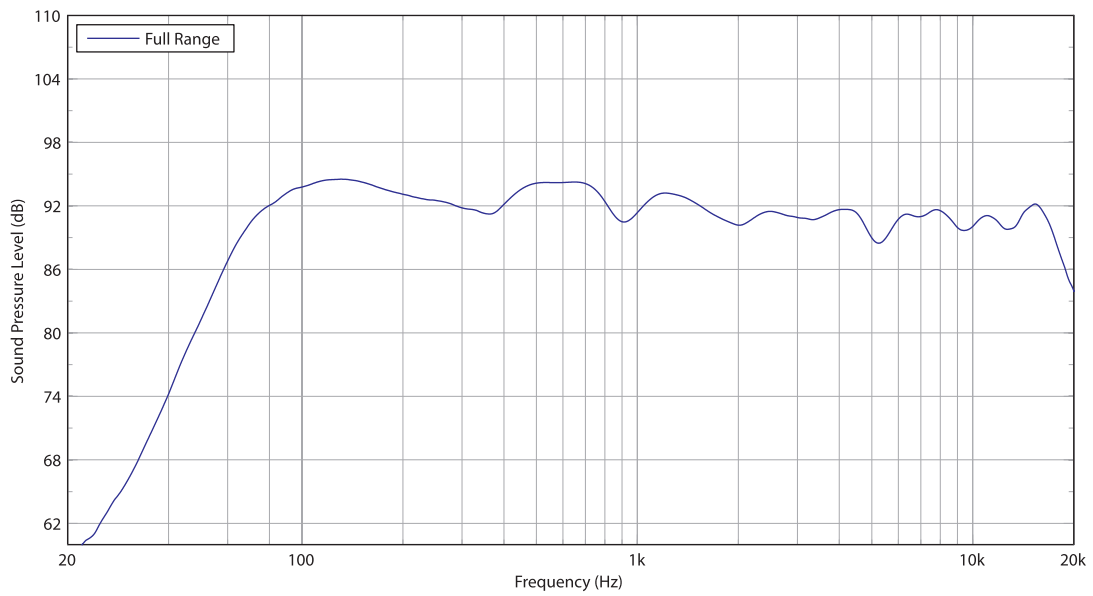

Impedance

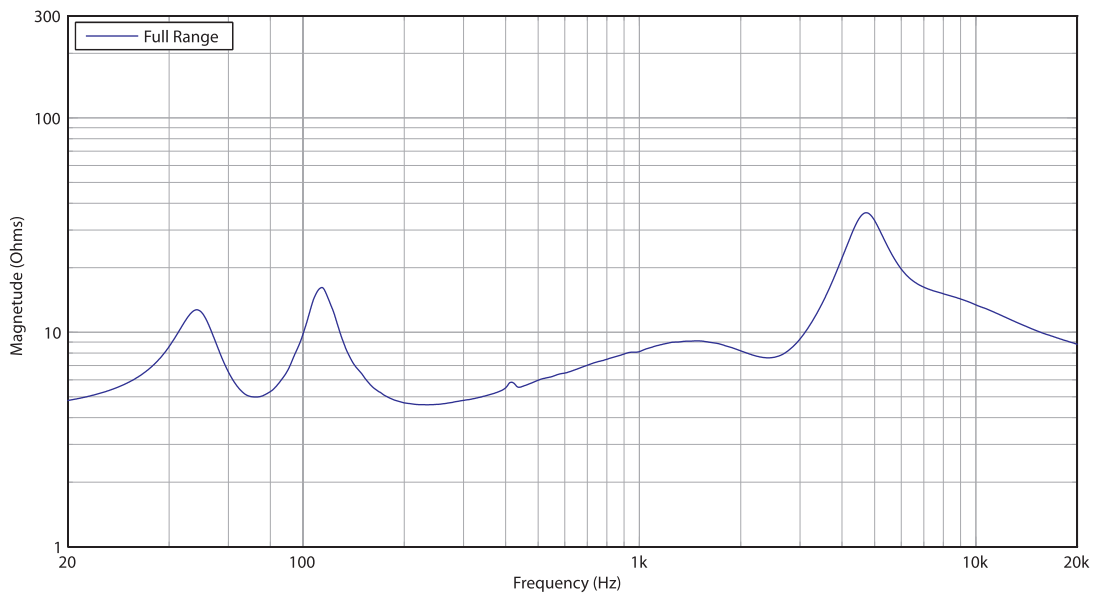

iNSPIRE iP82

2 Way 8" Full Range Loudspeaker for
Portable PA Applications

Horizontal Beamwidth

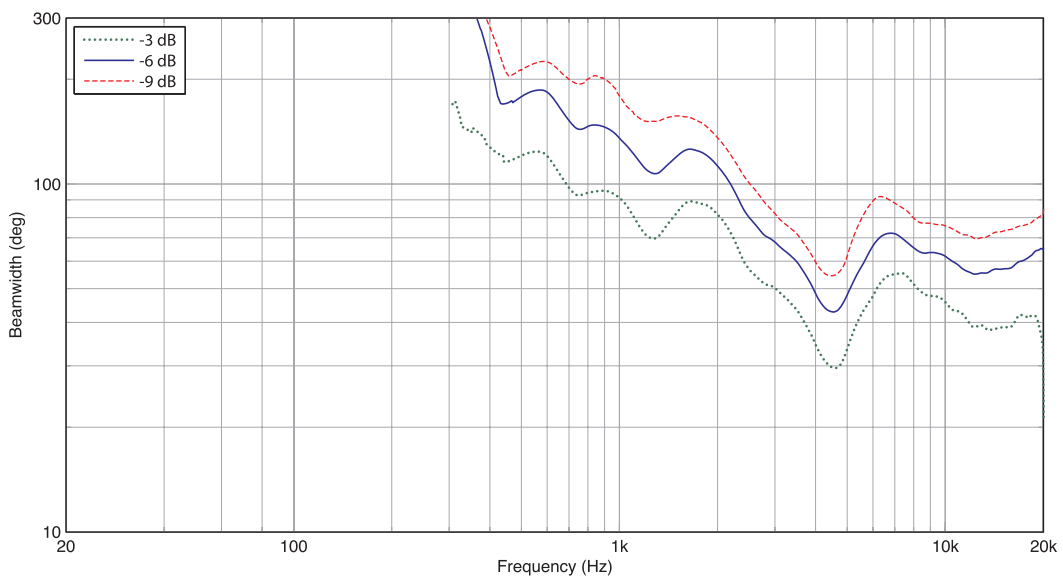

Vertical Beamwidth

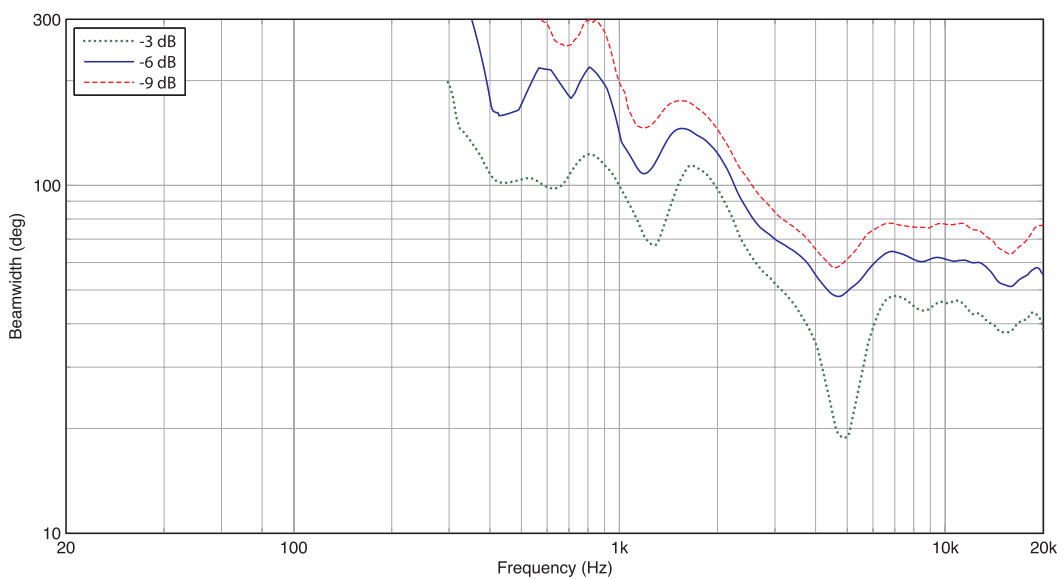

iNSPIRE iP82

2 Way 8" Full Range Loudspeaker for
Portable PA Applications

Horizontal Polar Plots

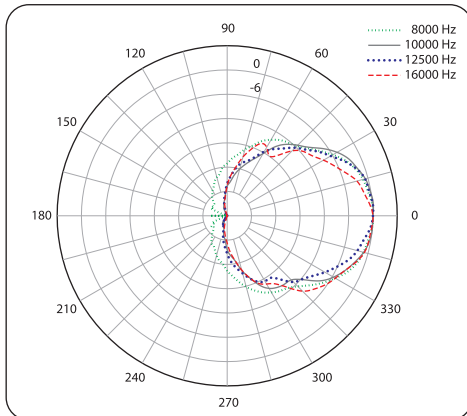
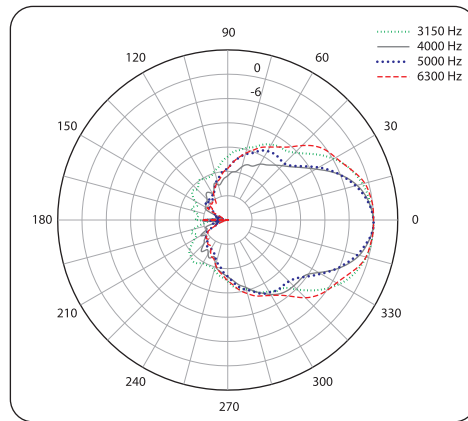
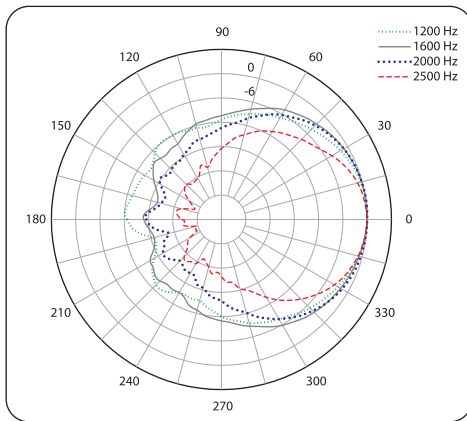
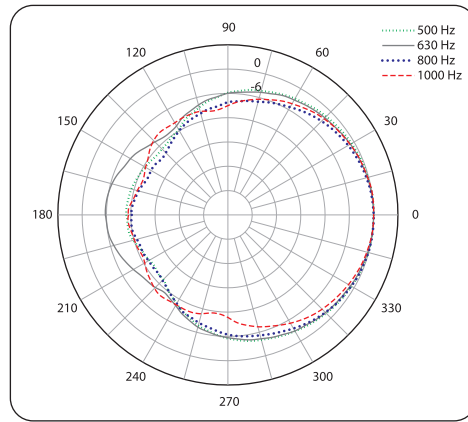
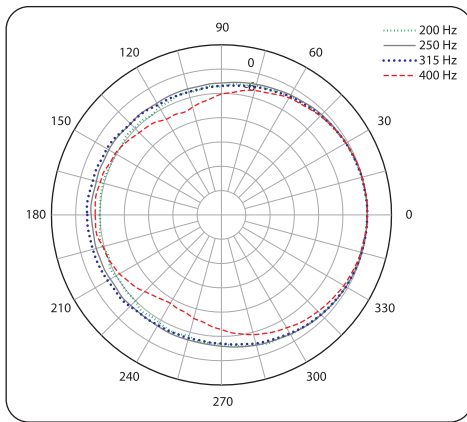

Portable Speakers

iNSPIRE iP82

2 Way 8" Full Range Loudspeaker for
Portable PA Applications

Vertical Polar Plots

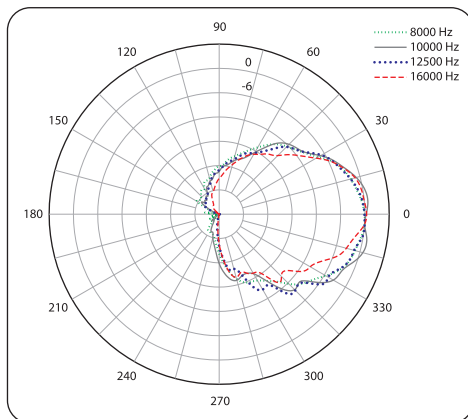
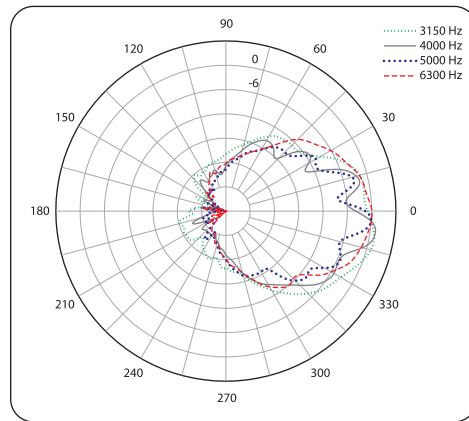
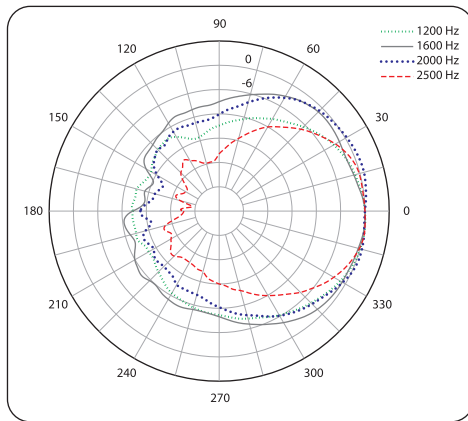
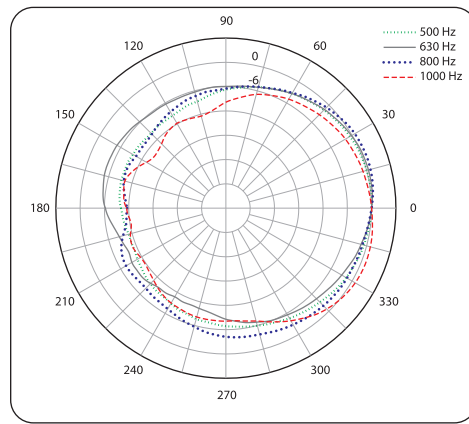
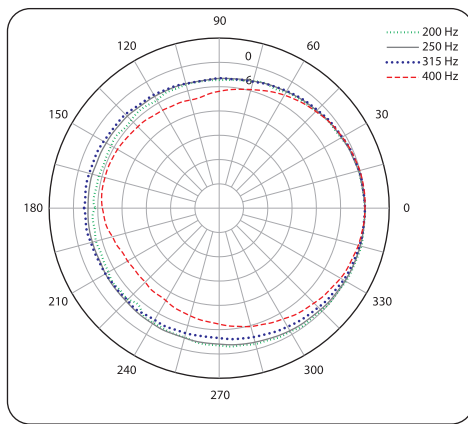

iNSPIRE iP82

2 Way 8" Full Range Loudspeaker for
Portable PA Applications

Dimensions

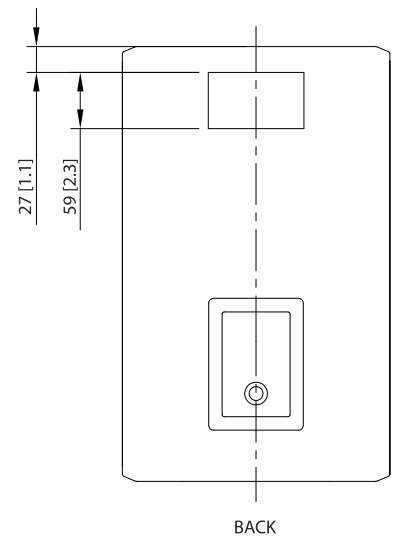
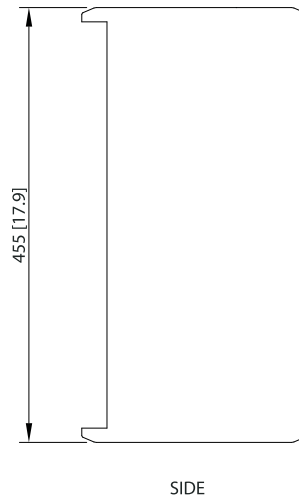
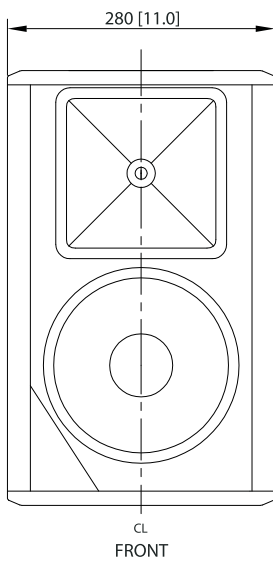
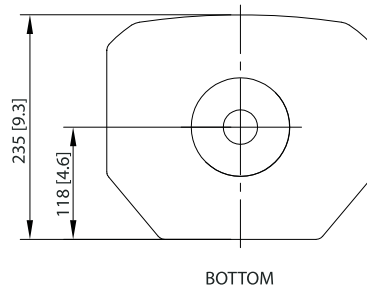
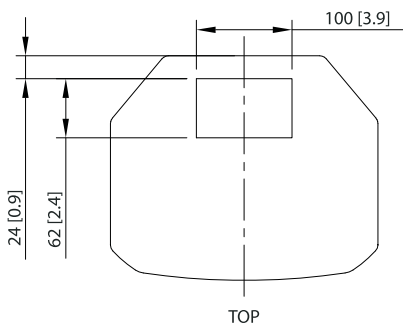

iNSPIRE

iP82

2 Way 8" Full Range Loudspeaker for
Portable PA Applications

Technical Specifications

System

Frequency response	70 Hz - 18 Hz \pm 3 dB 58 Hz - 20 Hz -10 dB
Nominal dispersion	70° H x 70° V @ -6 dB points
Power handling (IEC)	150 W continuous, 600 W peak
Sensitivity	91 dB (1 W @ 1 m)
Maximum SPL	113 dB continuous, 119 dB peak
Impedance	4 Ω
Components	1 x 8" (203 mm) LF drive 1 x 1" (25 mm) HF compression driver

Enclosure

Connectors	1 x Neutrik speakON* NL4
Wiring	Pins 1+ / 1- input, pins 2+ / 2- N/C
Dimensions HWD	455 x 280 x 235 mm (17.9 x 11.0 x 9.3")
Net weight	9.3 kg (20.5 lbs)
Construction	15 mm (5/8") birch plywood
Finish	Semi matt black paint
Grille	Powder coated perforated steel

iNSPIRE

iP82

2 Way 8" Full Range Loudspeaker for
Portable PA Applications



iNSPIRE iP82

2 Way 8" Full Range Loudspeaker for
Portable PA Applications



iNSPIRE iP82

2 Way 8" Full Range Loudspeaker for
Portable PA Applications

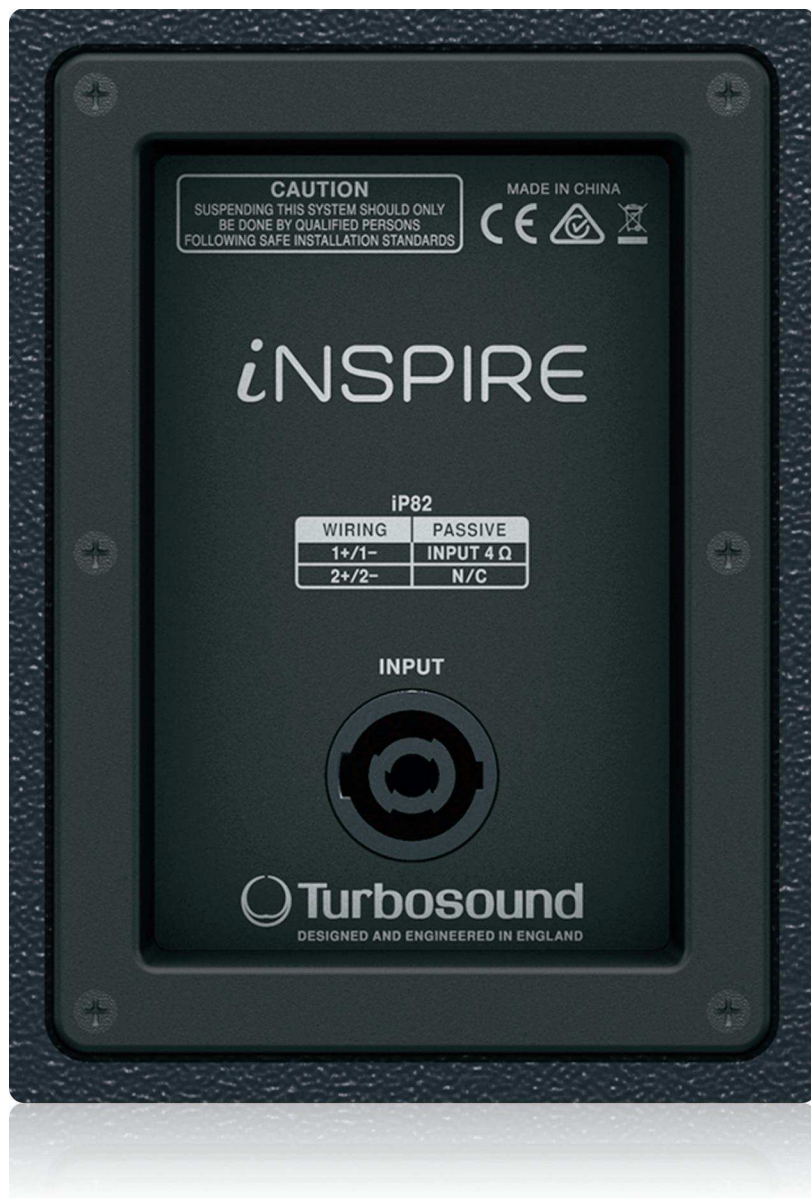

For service, support or more information contact the TURBOSOUND location nearest you:

Europe
MUSIC Group Services UK
Tel: +44 156 273 2290
Email: CARE@music-group.com

USA/Canada
MUSIC Group Services NV Inc.
Tel: +1 702 800 8290
Email: CARE@music-group.com

Japan
MUSIC Group Services JP K.K.
Tel.: +81 3 6231 0454
Email: CARE@music-group.com

MUSIC Group accepts no liability for any loss which may be suffered by any person who relies either wholly or in part upon any description, photograph, or statement contained herein. Technical specifications, appearances and other information are subject to change without notice. All trademarks are the property of their respective owners. MIDAS, KLARK TEKNIK, LAB.GRUPPEN, LAKE, TANNOY, TURBOSOUND, TC ELECTRONIC, TC-HELICON, BEHRINGER, BUGERA, DDA and TC APPLIED TECHNOLOGIES are trademarks or registered trademarks of MUSIC Group IP Ltd. © MUSIC Group IP Ltd. 2015 All rights reserved.