

Digital Mixers

MR12

12-Input Digital Mixer for iPad/Android Tablets with 4 MIDAS PRO Preamps, 8 Line Inputs, Integrated Wifi Module and USB Stereo Recorder



- ⊗ iPad*/Android* tablet controlled 12-input digital mixer for studio and live application
- ⊗ 4 award-winning MIDAS PRO microphone preamplifiers
- ⊗ Built-In Tri-Mode Wifi router for direct operation—no need for external routers
- ⊗ Dugan*-style Auto-Mixing automatically manages microphone gain sharing
- ⊗ USB connector for uncompressed stereo WAV recording and playback
- ⊗ 4 digital signal processing effects engines
- ⊗ Rack ears and protection bumpers included for flexible rack and onstage applications
- ⊗ 6 aux buses and main LR with inserts, full dynamics processing and 6-band parametric or 31-band graphic EQ
- ⊗ 2 TRS aux outputs and 2 XLR main outputs plus phones connector
- ⊗ 40 bit floating point digital signal processing
- ⊗ Free iOS, Android and PC/Mac*/Linux* apps available for remote operation via Ethernet, LAN or WiFi
- ⊗ MIDI In/Out allows controlling the mixer via MIDI equipment
- ⊗ Future firmware updates, incl. new FX "Plug Ins", downloadable from midasconsoles.com free of charge

The MIDAS M32 completely redefined what is possible from a digital mixer – and thousands of users are enjoying the results. Now that technology has been incorporated into the small but powerful MR12 rack-mountable mixer, which will forever change the way you record and the way you play live music.

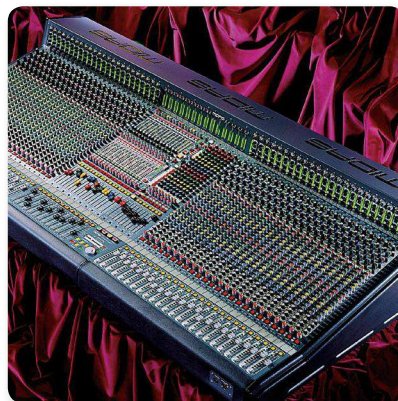

enable you to move about the venue or the tracking room and manipulate all the parameters of your mix, and the performers have the freedom to dial-in a shared monitor mix. Advanced engineering and meticulous design combine to deliver professional-grade performance and impressive affordability – the MR12.

A Mixer Whose Time has Come

Over the past few years, the world of recording and performance audio has experienced a major paradigm shift, one that requires musicians and performers alike to take advantage of emerging technologies that offer flexibility and ease of use. The MR12 is an 12-input portable mixer housed in a sturdy stage box design for use with iPad and Android tablets. It is ideally suited for both live and studio applications thanks to 4 award-winning MIDAS PRO mic preamps, integrated Wifi module for wireless control, MIDI I/O – and a USB connector for storing files or the recording and playback of uncompressed stereo WAV files. Free iOS, Android and PC apps

MR12

12-Input Digital Mixer for iPad/Android Tablets with 4 MIDAS PRO Preamps, 8 Line Inputs, Integrated Wifi Module and USB Stereo Recorder

- ⊗ Auto-ranging universal switch-mode power supply
- ⊗ 3-Year Warranty Program*
- ⊗ Designed and engineered in the U.K.

4 MIDAS PRO Mic Preamps

The MIDAS PRO mic amp was developed for the PRO Series mixing consoles and is also found in the M32 – and has been recognised by leading live sound and recording engineers as the very essence of the famous MIDAS sound. It is here in the MR12 that more than 40 years of design excellence has come together with premium grade components to provide unparalleled warmth and depth, subtle ambience, and immaculate spatial positioning – for more precise imaging than competing models. The award-winning MIDAS microphone preamplifier has inspired generations of live sound engineers to their best work, creating sonic landscapes that have captivated audiences worldwide. MR12 comes equipped with 4 MIDAS PRO preamps, all of which are literally ready for your input via the Neutrik combo connectors with locking latches.



*iPad and Mac are trademarks of Apple Inc. Android is a trademark of Google Inc. Linux is the registered trademark of Linus Torvalds in the U.S. and other countries. All third-party trademarks are the property of their respective owners. Their use neither constitutes a claim of the trademark nor affiliation of the trademark owners with MUSIC Group. Product names are mentioned solely as a reference for compatibility, effects and/or components. iPad is not included. Warranty details can be found at music-group.com.

Digital Mixers

MR12

12-Input Digital Mixer for iPad/Android Tablets with 4 MIDAS PRO Preamps, 8 Line Inputs, Integrated Wifi Module and USB Stereo Recorder

Built-In Tri-Mode Wifi Router

Designed for the ultimate in mobility, the MR12 comes with an integrated Wifi module for direct control of your mixer's functions – without the need to setup and configure an external router. The MR12 gives you the freedom to focus on your mix, while allowing you to move about the venue to experience what every part of the audience is hearing. Plus you can adjust live monitor wedges from the artist's perspective – or better yet, let them mix their own IEMs and floor monitors via their own tablets.

1. Access Point is the easiest way to connect up to 4 clients directly and concurrently (i.e., iPad, Android smartphone/tablet or laptop). This mode should have your remote control up and running in less than a minute.
2. Wifi Client allows you to add your mixer to the existing wireless network where the controlling apps and devices are connected.
3. Alternately, wired connections can be made directly to your PC, to a local area network (LAN), or when connecting to a dedicated Wifi router, e.g., for extended range or 5 GHz applications.

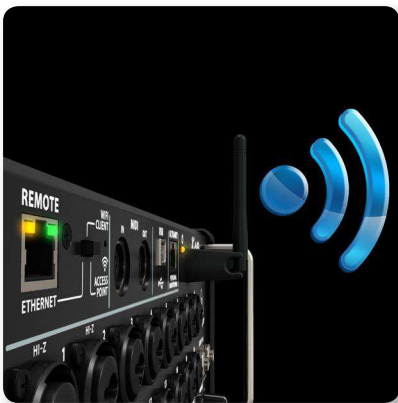

Recording Simplified

MR12 features a convenient USB connector that makes it easy to record and playback uncompressed stereo WAV files of your mix. Dial in the perfect live mix with effects and zero-latency, while sending a dedicated stereo mix to your USB thumb drive for recording – or use the USB connector for playing background music during your break. Stereo playback can also be routed to mono input channels for sending click and backing tracks to monitoring and main mixes respectively.

Whether you are making rock history in the studio, or you want to capture intimate live performances – it has never been easier to record stunning tracks with exceptional clarity.



MR12

12-Input Digital Mixer for iPad/Android Tablets with 4 MIDAS PRO Preamps, 8 Line Inputs, Integrated Wifi Module and USB Stereo Recorder



Revolutionary Auto-Mixing

When your application calls for a multiple-microphone setup, such as an onstage panel discussion, press conference or courtroom proceeding, etc., it can become a challenge to maintain so many open mics – and preserve maximum gain and priority for the moderator.

A major first for compact audio mixers, our revolutionary M AIR Gain Sharing technology can easily manage fully automated mixes with up to 4 live microphones. Based on the legendary Dan Dugan automix system, the MR12's gain sharing paradigm automatically controls the levels of all selected microphones in real time, without any gating artifacts or noise modulation.

This function dramatically reduces the typical feedback, studio noise and comb filtering challenges that can occur when two, or more mics are in close proximity of each another. M AIR Gain Sharing technology provides a consistent system gain structure, even when multiple speakers are talking at the same time.

4 Onboard M32 Effects Engines

Equipped with the very same FX engines as the now legendary M32 Digital Mixing Console, the onboard virtual FX Rack provides access to four true-stereo (8 mono), multi-effects processors including delay, chorus, dynamics – plus the MR12 can run production-quality, true-stereo reverbs concurrently with 31-band EQ on the main and aux buses, all without the need for any additional hardware.

You can select any combination of high-end simulations of legendary studio effects, such as the Lexicon 480L and PCM70, as well as the EMT250 and Quantec QRS reverbs. Onboard processing means your computer no longer has to do the heavy lifting during a mixing session with DAW plugins, as the MR12 has a whole studio of FX under its bonnet.

Custom-designed, and physically modeled after some of the most iconic and sought-after processors, all effects run inside the low-latency environment of the M32 mix engine, ensuring flawless performance, flexible routing and the end of cable faults.



Digital Mixers

MR12

12-Input Digital Mixer for iPad/Android
Tablets with 4 MIDAS PRO Preamps,
8 Line Inputs, Integrated Wifi Module and
USB Stereo Recorder

High-End FX Racks at Your Finger Tips

The immaculate tube signal path in Teletronix' LA-2A Leveling Amplifier has left its exceptional clarity, its rich and warm compression on countless albums of the past decades.



The ultra-smooth optical attenuator is closely modeled in our LEISURE COMPRESSOR. It provides breezy, natural and effortlessly musical compression. (Inspired by Teletronix LA-2A*)

When Urei released the 1176LN Limiting Amplifier in the late 60's, it broke new ground. Field Effect Transistors employed were just invented, and the 1176 was one of the first audio processors to benefit from this new technology.



Our digital reincarnation, **ULTIMO COMPRESSOR**, is based on the early Rev. E model, and authentically captures the smooth character of the original Class-A output stage and its FET's legendary fast Attack. (Inspired by Urei 1176LN*)

Digital Mixers

MR12

12-Input Digital Mixer for iPad/Android Tablets with 4 MIDAS PRO Preamps, 8 Line Inputs, Integrated Wifi Module and USB Stereo Recorder

The Fairchild 670 tube compressor not only achieves record bids in high-end vintage gear auctions, it also delivers some of the finest colorations in compressor history. Two small trim VRs preset the control side chain action, a six-step switch determines the timing, and the two large Input and Threshold knobs adjust the levels.



Our FAIR COMPRESSOR model is true to the original signal path, and conveniently provides models for dual, stereo-linked or M/S operation. (Inspired by Fairchild 670*)



The COMBINATOR is an amazing 5-band compressor that emulates famous broadcasting and mastering compressors. A highly complex processor, the COMBINATOR utilizes automatic parameter control that produces stunning and “inaudible” results. Makeup-gain for each frequency band will automatically be adjusted by the Spectral Balance Control (SBC) function, to maintain a balanced audio spectrum.



The XTEC EQ1 emulates one of the undisputedly best passive studio equalizers ever manufactured. Virtually indescribable, recording engineers claim the Pultec EQP-1a to be the “secret sauce” of sound enhancement. We analyzed this classic to the core and created an exact physical model that reproduces the multi-faceted sound in painstaking detail. Even the transformers and tube output stage have been faithfully modeled! (Inspired by Pultec EQP-1a*)

Digital Mixers

MR12

12-Input Digital Mixer for iPad/Android Tablets with 4 MIDAS PRO Preamps, 8 Line Inputs, Integrated Wifi Module and USB Stereo Recorder



Put simply, Pultec literally wrote the book on passive equalization. By digitally “rebuilding” every aspect of this original classic, we captured the very essence in our mid-range focused parametric equalizer XTEC EQ5. Our digital re-incarnation authentically emulates the smooth character of its rather unique components. (Inspired by Pultec MEQ5*)



The new **SUB OCTAVER** provides two channels of earth-shattering sub-harmonics generation, one or even two octaves below the input signal. While originally designed for bass players, the effect can be adjusted for Hi, Mid and Low frequency tracking to apply to a wide range of applications. This is your secret weapon for beatboxing...



The **EDISON EX1** is the reincarnation of one of our own analog classics. This remarkably effective tool allows manipulation of the stereo field. Selectable Mono or Stereo I/O modes allow the processing, or creation, of Mono/Stereo recorded sound sources. (Inspired by BEHRINGER EDISON)

Digital Mixers

MR12

12-Input Digital Mixer for iPad/Android Tablets with 4 MIDAS PRO Preamps, 8 Line Inputs, Integrated Wifi Module and USB Stereo Recorder



The **SOUND MAXER** restores natural brilliance and clarity to any audio signal by adjusting the phase and amplitude integrity to reveal more of the natural texture of the sound, which is often hidden when using some effects and equalizers. (Inspired by Sonic Maximizer 482i*)

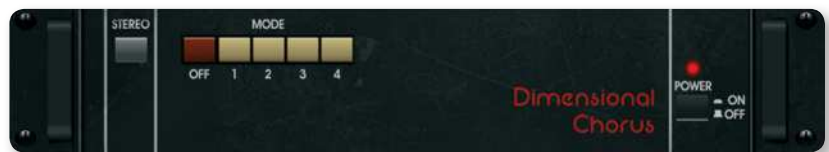

The **DIMENSIONAL CHORUS** is the perfect emulation of what has been referred to as “the best analog Chorus unit ever created”. Four simple Mode preset buttons activate amazing effects, best described as “space” and “dimension”. Absolutely faithful to the original, multiple preset buttons can be pressed simultaneously. (Inspired by Roland Dimension D Chorus*)



MODULATION DELAY combines three of the most-used time modulation effects into one easy-to-operate unit. Enjoy true-stereo delay with a lush and spacious chorus, topped off with your choice of three very unique reverb models, Ambience, Club and Hall.

Digital Mixers

MR12

12-Input Digital Mixer for iPad/Android
Tablets with 4 MIDAS PRO Preamps,
8 Line Inputs, Integrated Wifi Module and
USB Stereo Recorder



ENHANCERS let you emphasize the Bass, Midrange and Hi output at selectable frequencies, allowing you to generate maximum punch, clarity and detail – without turning up the overall volume. (Inspired by SPL Vitalizer*)



EXCITERS increase presence and intelligibility in live sound applications, and are indispensable for adding clarity, air and harmonic overtones in the studio. (Inspired by Aphex Aural Exciter*)

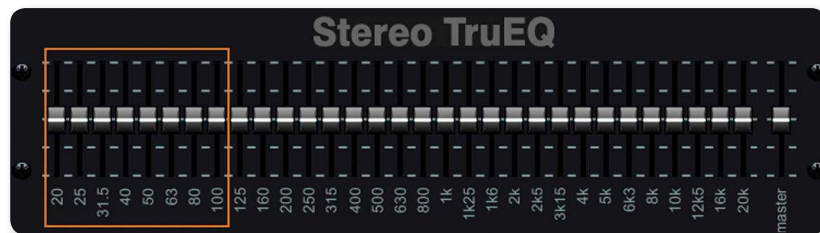

Unlike typical graphic EQs, our **STEREO TruEQ** delivers the exact frequency response for the new fader setting, taking neighboring fader settings into account – for surgical and responsive filtering or general room equalization (Modeled after BEHRINGER UltraCurve DEQ2496). The MR12 can provide up to 16 mono graphic EQs – one in each of the 6 Aux Buses and Main LR, plus 8 additional mono GEQ effects (4 stereo) that may be inserted into channels.

Digital Mixers

MR12

12-Input Digital Mixer for iPad/Android Tablets with 4 MIDAS PRO Preamps, 8 Line Inputs, Integrated Wifi Module and USB Stereo Recorder



VINTAGE ROOM stands out head and shoulders over other competing reverberation strategies in the way it models sound propagation in the air and room resonances. Invented in the early '80s, the role model delivered authentic room character from an algorithmic reverb long before convolution-based processing was available. It is an ideal reverb for mixes or sub-groups, as it adds space to complex signals – highly valued in classical music and broadcasting environments. (Inspired by Quantec QRS*)



PLATE REVERB emulates the characteristics of a plate reverb chamber with control over the damping pad, modulation depth and speed, and crossover. This classic effect will give your tracks the sound heard on countless hit records since the late 1950s. (Inspired by Lexicon PCM70*)



The **3-TAP DELAY** in the M32 records the input signal and then echoes it back after a user-definable period of time and number of repeats. What makes the stereo and triple delay useful and outstanding is the linked tap-timing and musical choice of echo patterns. Use the 3-TAP DELAY to fatten up vocals and instruments, or to add an enhanced spatial element to any performance.

Digital Mixers

MR12

12-Input Digital Mixer for iPad/Android Tablets with 4 MIDAS PRO Preamps, 8 Line Inputs, Integrated Wifi Module and USB Stereo Recorder

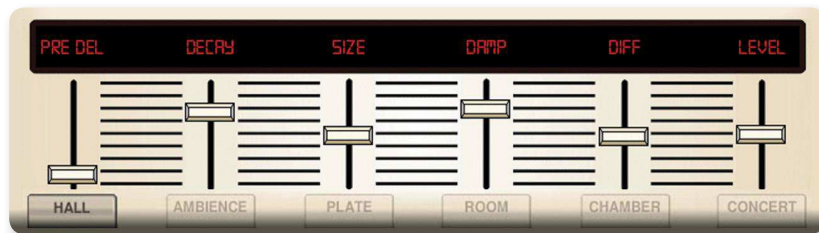

The **HALL REVERB** effect provides a broad spectrum of reverberation possibilities, from small room to large, or even cavernous proportions. When softly mixed with the original signal, Hall Reverb can be used to create a warm, more natural sound. (Inspired by Lexicon 480L*)

The Lexicon 480L* has been recognized as the gold standard of digital reverb. In addition to the Hall Reverb program, we have included four more of the finest reverb models: Ambience, Rich Plate, Room and Rich Chamber. These models precisely capture all nuances based on our "True Physical Modeling", and our algorithms even incorporate the unit's AD/DA gain stepping converters – nailing the entire analog and digital circuit paths right down to the last detail. (Inspired by Lexicon 480L*)



This handy dynamic **FLANGER & DELAY** duo blends the "whoosh" of soaring jet planes with classic Delay, and can be adjusted from mild to wild. This combination effect only takes up one FX slot. (Inspired by Lexicon PCM70*)



WAVE DESIGNER is a powerful tool for adjusting signal transients and dynamics such as attack and sustain. Use it to make a snare drum really "crack" in the mix or level out volume inconsistencies of slap bass tracks. (Inspired by SPL Transient Designer*)

Digital Mixers

MR12

12-Input Digital Mixer for iPad/Android
Tablets with 4 MIDAS PRO Preamps,
8 Line Inputs, Integrated Wifi Module and
USB Stereo Recorder

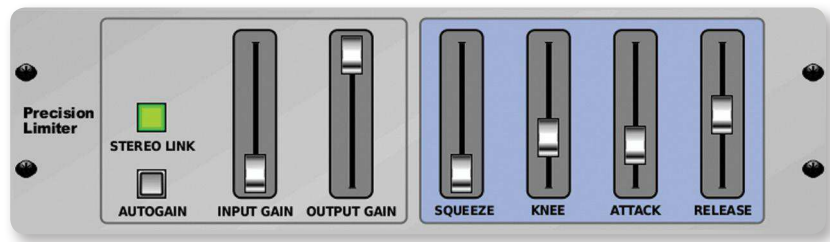

The **STEREO PRECISION LIMITER** is perfect for setting a precise volume limits, ensuring distortion-free and optimal signal integrity. Use the Stereo Precision Limiter to boost quiet signals or reduce the level of "hot" signals to prevent clipping. (Inspired by Sony Oxford Dynamics*)



The **DE-ESSER** is a "must-have" tool for reducing the amount of sibilance in vocal mics while adeptly preserving the natural voice timbre of a performance. Use it to enhance the smoothness of the upper mid to high frequencies in vocals as well as drum overheads and strings, etc. (Inspired by SPL 1219*)

Digital Mixers

MR12

12-Input Digital Mixer for iPad/Android
Tablets with 4 MIDAS PRO Preamps,
8 Line Inputs, Integrated Wifi Module and
USB Stereo Recorder



Based on the legendary EMT250, the **VINTAGE REVERB** delivers a shimmering, bright reverb that will not drown out or overpower your live/recorded tracks. Use the VINTAGE REVERB to sweeten vocals and snare drums without sacrificing clarity. (Inspired by EMT250 Plate Reverb*)



Taking up only one FX slot, the **CHORUS & CHAMBER** effect combines the shimmer and doubling characteristics of a studio-grade Chorus with the sweet sound of a traditional Chamber reverb. (Inspired by Lexicon PCM70*)

MR12

12-Input Digital Mixer for iPad/Android
Tablets with 4 MIDAS PRO Preamps,
8 Line Inputs, Integrated Wifi Module and
USB Stereo Recorder

100-Band RTA for all Channel/Bus EQs

The MR12 includes a high-resolution 100-band Real Time Analyzer (RTA), with full Bar and Spectrograph views. This high-resolution RTA displays the audio energy distribution in 100 frequency bands over time – capturing a sonogram window of a full 10 seconds.

Switch between the Large RTA view, displaying any available signal in full screen resolution, or the Combined RTA view shown above each of the channel and bus EQ curves – and see the results of your filtering choices. Additionally, the RTA can be displayed on top of the 31-band graphic EQs in the Main LR or Aux buses. Monitoring and controlling frequencies has never been easier!

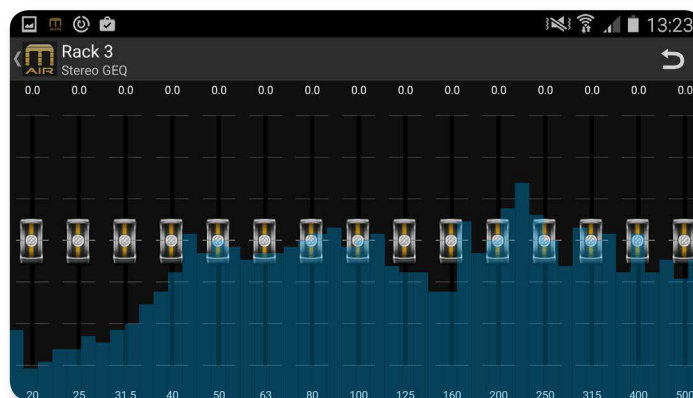
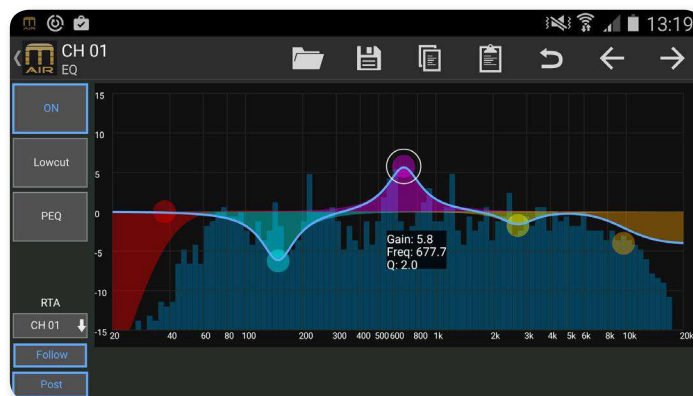

MR12

12-Input Digital Mixer for iPad/Android
Tablets with 4 MIDAS PRO Preamps,
8 Line Inputs, Integrated Wifi Module and
USB Stereo Recorder

Uncompromised Channel Processing

The MR12 allows you to achieve the same incredible level of EQ finesse as the award-winning M32 thanks to its 100-band Real Time Analyzer, which is built into every input channel and bus EQ. Visual feedback built into the control app allows you to see and make fast, surgical adjustments to frequencies in need of a boost or a cut. You will wonder how you ever EQ'd without it!

Every input channel also features Low-Cut, 4-band fully parametric EQ and the same Gate and Compressor dynamics suite found in the M32 – with one very special addition; you can choose either Expert or Simple functionality. In Expert mode, you can drill down and take total control over every nuance of your dynamics. Or, if you are more of the 'plug and play' type, Simple mode lets you either select from one of 4 carefully-optimized presets – or load your own channel templates. Add to this 40-Bit, floating-point DSP and you will experience virtually "unlimited" dynamic range with no internal overload and near-zero overall latency.

In addition to the Main L/R bus for Front of House, 2 Aux buses are provided for dialing in the perfect monitor mixes, or creating a dedicated mix for your USB stereo recording – complete with inserts, dynamics, and either a 6-band parametric EQ or 31-band graphic EQ. And if you want even more precise control over your EQ, 100-band RTAs are available for all of these buses, too.

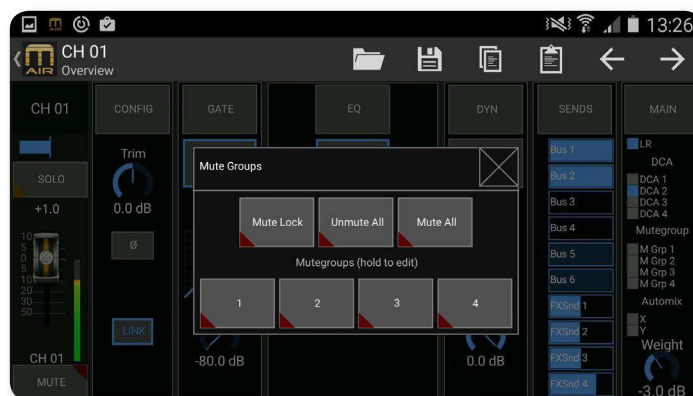
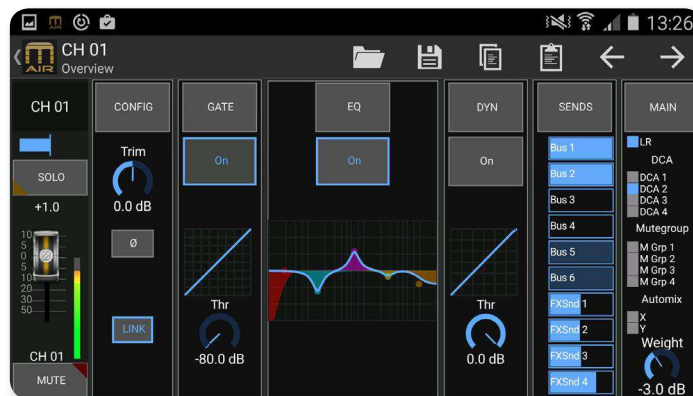

MR12

12-Input Digital Mixer for iPad/Android
Tablets with 4 MIDAS PRO Preamps,
8 Line Inputs, Integrated Wifi Module and
USB Stereo Recorder

MIDI In/Out for Live Performance Controllers

The physical MIDI I/O port on the MR12 mixer can also be used for connecting external MIDI controllers, such as [BEHRINGER X-TOUCH](#) or [B-CONTROL](#) products, for dynamically controlling channel level, muting and panorama adjustments during your performance. The installed firmware also supports the Mackie Control protocol, allowing you to easily apply comprehensive remote editing and parameter adjustments via any compatible MIDI device.



Digital Mixers

MR12

12-Input Digital Mixer for iPad/Android Tablets with 4 MIDAS PRO Preamps, 8 Line Inputs, Integrated Wifi Module and USB Stereo Recorder

Networked or MIDI Control via BEHRINGER X-TOUCH Surface

MIDAS M AIR mixers and BEHRINGER X-TOUCH control surfaces communicate in an optimised XCTL protocol mode for seamless access to almost all mixer parameters. The control surface's individual channel LCDs indicate the corresponding mixer channel color, name and parameters, while its 9 motor faders, mute, solo and select buttons offer a hands-on mixing experience. Connections can be made by: directly linking MIDI I/O ports between M AIR mixer and X-TOUCH; directly connecting the Ethernet ports of X-TOUCH and M AIR mixer; or via IP based Ethernet networks Wifi/LAN.



Dedicated Apps and Software – All Platforms Covered

Since we wanted the MR12 to benefit from the best remote apps, we engaged dedicated development teams for the iOS*, Android*, and PC/Linux/Mac* based remote control applications. When you download an M AIR app for your operating system, you can rest assured that you will get the fully optimized experience we intended. Future firmware updates will be available free of charge and add even more professional-grade features, FX "Plug-Ins", and functionality.



Digital Mixers

MR12

12-Input Digital Mixer for iPad/Android Tablets with 4 MIDAS PRO Preamps, 8 Line Inputs, Integrated Wifi Module and USB Stereo Recorder

M AIR EDIT (PC/Mac/Linux/RPi)

If your application requires a computer for MIDAS M AIR mixer remote control, then M AIR EDIT was made just for you. Simply copy and launch the free software with your computer, connect to the mixer via its built-in Ethernet (LAN) connector using a Cat 5e cable (max. 100 m length) – and all M AIR mixer functions are instantly mirrored on your computer screen. Since a PC screen is larger than the one on your telephone, M AIR EDIT allows the opening and scaling of more app windows, such as routing or FX editing – letting you decide how much information you need at a glance. All touch screens are supported, or you can use a mouse to adjust your physical mixer's settings. You can even control multiple mixers remotely from a single computer, or create several strategically placed computer stations to control the same mixer. With M AIR EDIT, your PC, Linux or Mac computer becomes your virtual mixer – both live and in the studio.

Download the free M AIR EDIT software from midasconsoles.com.

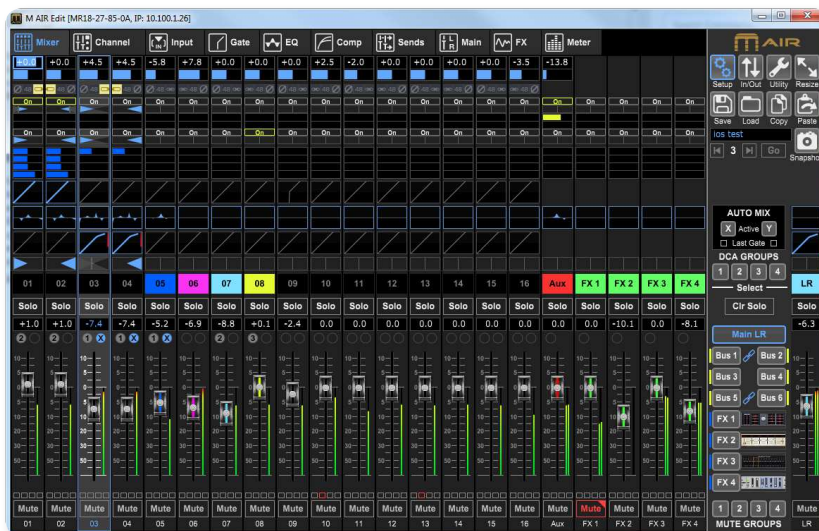

Digital Mixers

MR12

12-Input Digital Mixer for iPad/Android
Tablets with 4 MIDAS PRO Preamps,
8 Line Inputs, Integrated Wifi Module and
USB Stereo Recorder

M AIR for iPad

Front of House is wherever you and your iPad are – thanks to the new M AIR app for iPad. Simply download the free app to your iPad, set the MIDAS M AIR mixer to Access Point mode and connect your iPad to the MR12 network that will show up. After launching the M AIR app, select the mixer image, and all of your M AIR mixer's settings can now be adjusted directly from your iPad. You can save your favorite scenes, and load previously stored scenes and presets to/from your iPad or customize your channel layout – all with the support of innovative drag 'n' drop functionality.

Download the free M AIR App for iPad from the Apple App Store



Digital Mixers

MR12

12-Input Digital Mixer for iPad/Android
Tablets with 4 MIDAS PRO Preamps,
8 Line Inputs, Integrated Wifi Module and
USB Stereo Recorder

M AIR for Android

Designed specifically for all Android mobile devices (4.0 or higher), which includes tablets and smartphones, the app can be used in one of two modes: full access mixing mode; or bound to a specific Aux bus for creating personal monitor mixes remotely on MIDAS M AIR mixers. This free and easy to learn M AIR app offers a full access mixing mode, with the app providing control over all channel processing including the RTA overlay, effects editing, storing/loading scenes or presets, and much more – whether you are running a 12" tablet or a 5" smartphone.

Download the free M AIR for Android App from the Google Play Store

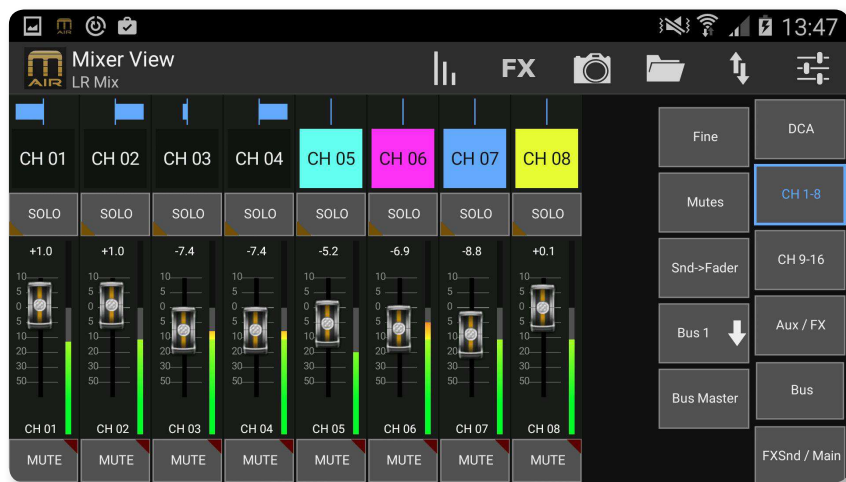

Digital Mixers

MR12

12-Input Digital Mixer for iPad/Android
Tablets with 4 MIDAS PRO Preamps,
8 Line Inputs, Integrated Wifi Module and
USB Stereo Recorder

M AIR Q Personal Monitoring for Android

Designed specifically with Android smartphones in mind (2.2 or higher), the app can be used to control a specific Aux bus for creating personal monitor mixes remotely on M AIR mixers. Using this free and easy to learn app, each performer can use their Android device to dial-in the perfect personal IEM or wedge monitor mix, without having to consult the audio engineer for assistance. Up to 4 MCA groups can be populated with any of the input channels, controlling several signals in one move for minimal distraction during performance. The app also allows panning channels to stereo linked Aux buses for stereo-IEM applications. With the M AIR Q App for Android, personal monitor mixing just got a whole lot more personal – both live and in the studio!

Download the free M AIR Q for Android App from the Google Play Store

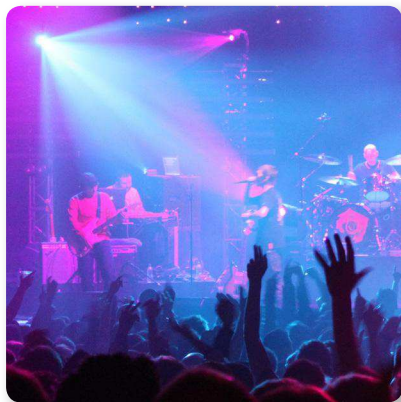

Superb Value

The feature-packed MR12 is the result of the engineering, manufacturing and application expertise of legendary console manufacturer MIDAS, the iconic signal processing genius of KLARK TEKNIK – and MUSIC's unique ability to deliver a superior value proposition. MR12's sound quality far surpasses that of competing models, both on paper and in performance. With 12 inputs, 4 MIDAS PRO mic preamps, 2 Aux buses, a built-in Wifi router, a USB connector for simple recording and playback of uncompressed stereo WAV files, MIDI I/O, and free downloadable apps for iOS, Android and PC, and a host of other high-end professional features, the M AIR MR12 is equipped to handle your most demanding audio application.

Visit your local dealer and take a closer look at the M AIR MR12 Digital Mixer, or get yours online – today!

You Are Covered

We always strive to provide the best possible Customer Experience. Our products are made in our own MUSIC Group factory using state-of-the-art automation, enhanced production workflows and quality assurance labs with the most sophisticated test equipment available in the world. As a result, we have one of the lowest product failure rates in the industry, and we confidently back it up with a generous 3-Year Warranty program.



Digital Mixers

MR12

12-Input Digital Mixer for iPad/Android
Tablets with 4 MIDAS PRO Preamps,
8 Line Inputs, Integrated Wifi Module and
USB Stereo Recorder

Dimensions

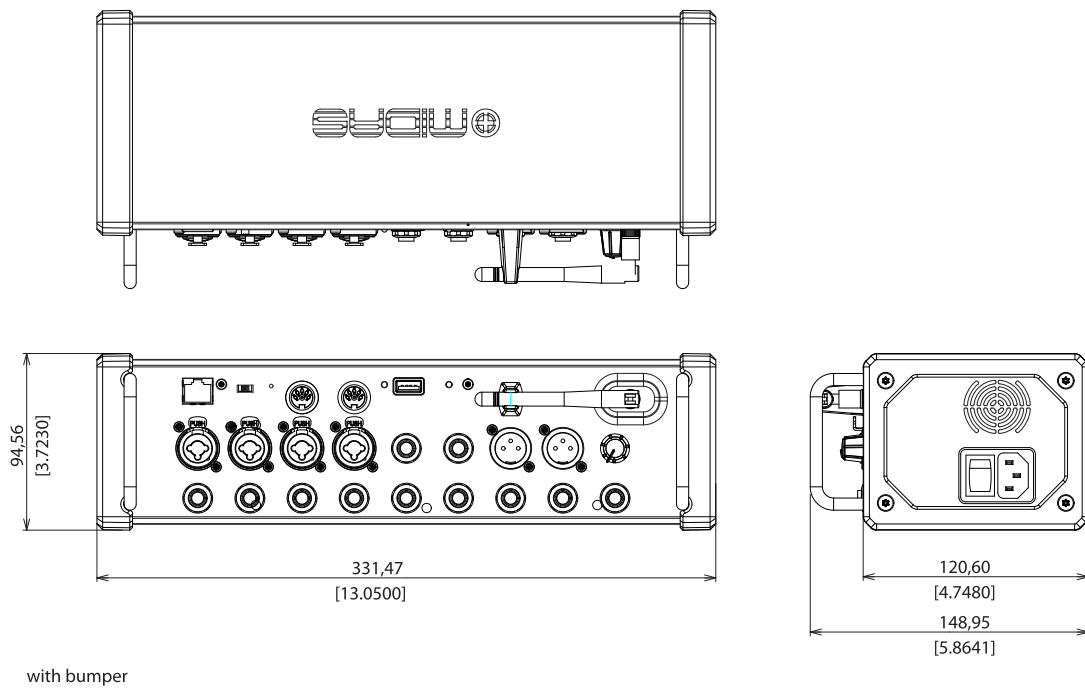

Digital Mixers

MR12

12-Input Digital Mixer for iPad/Android
Tablets with 4 MIDAS PRO Preamps,
8 Line Inputs, Integrated Wifi Module and
USB Stereo Recorder

Dimensions

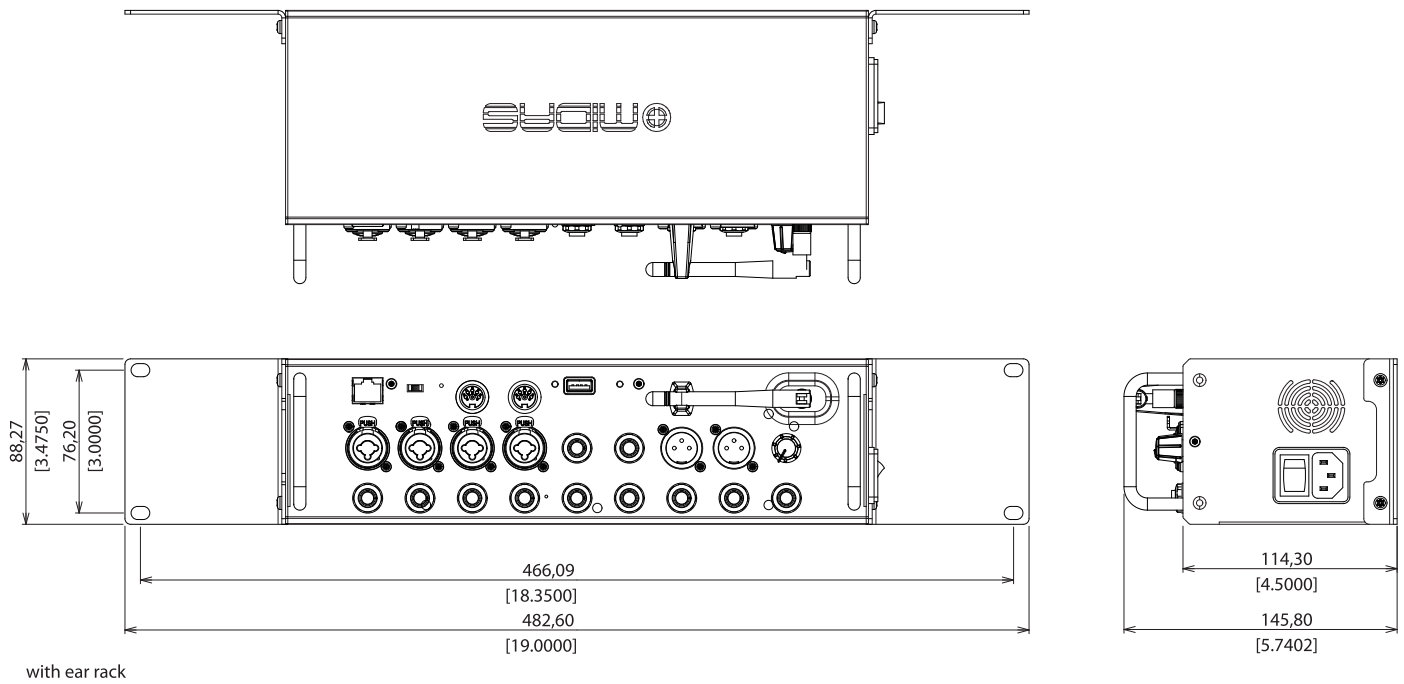

Digital Mixers

MR12

12-Input Digital Mixer for iPad/Android Tablets with 4 MIDAS PRO Preamps, 8 Line Inputs, Integrated Wifi Module and USB Stereo Recorder

Technical Specifications

Processing

Number of processing channels	16 input channels, 1 stereo USB return channel, 4 stereo FX return channels, 6 aux buses, main LR
Internal effects engines	4 true stereo
Signal processing	40-bit floating point
A/D-D/A conversion	24-bit @ 44.1 / 48 kHz, 115 dB dynamic range
Analog I/O latency*	0.8 ms

Connectors

Programmable mic preamps, designed by MIDAS PRO	4 XLR/TRS combo jacks, balanced
Line inputs	2 TRS, balanced
Main outputs	2 XLR, balanced
Aux outputs	2 TRS, balanced
Phones outputs	1 TRS
MIDI inputs / outputs	1/1 DIN
Ethernet	1 RJ45
USB port	Type A

Mic Input Characteristics

Preamp design	MIDAS PRO
THD + noise, unity gain, 0 dBu, 1 kHz	0.005%, unweighted
Phantom power, switchable per input	48 V
EIN noise, at +60 dB gain, 150R source	-125 dBu, 22 Hz - 22 kHz unweighted
CMRR, XLR, 1 kHz @ unity gain	Typically 65 dB
CMRR, XLR, 1 kHz @ +60 dB gain	Typically 90 dB

Input/Output Characteristics

Frequency range, @ 48 kHz sample rate, +/- 0.5 dB	20 Hz - 20 kHz
Dynamic range, analog in to analog out	107 dB, 22 Hz - 22 kHz unweighted
A/D dynamic range, preamp to converter	110 dB, 22 Hz - 22 kHz unweighted
D/A dynamic range, converter and output	111 dB, 22 Hz - 22 kHz unweighted
Cross talk rejection @ 1 kHz, adjacent channels	90 dB
Mic/Line 1-16 Input impedance XLR jack, unbal. / bal.	10 k Ω
Non clip maximum input level, XLR	+23.5 dBu
Hi-Z input impedance TRS jack, unbal. / bal.	1 M Ω / 2 M Ω
Line input 5-10 impedance TRS jack, unbal. / bal.	20 k Ω / 40 k Ω
Non clip maximum input level, TRS	+21 dBu

MR12

12-Input Digital Mixer for iPad/Android Tablets with 4 MIDAS PRO Preamps, 8 Line Inputs, Integrated Wifi Module and USB Stereo Recorder

Technical Specifications

Output Characteristics

Output impedance, XLR	50 Ω
Maximum output level, XLR	+21 dBu
Aux 1-2 output impedance, TRS	50 Ω
Aux 1-2 maximum output level, TRS	+21 dBu
Phones output impedance	50 Ω
Maximum phones output level	+21 dBu
Noise @ unity gain, 1 input assigned, XLR and TRS	-86 dBu, 22 Hz - 22 kHz unweighted
Noise when muted, XLR and TRS	-90 dBu, 22 Hz - 22 kHz unweighted

WLAN Module

Antenna	External, SMA connector, 50 Ω
Access Point, number of clients	Max. 4
IEEE 802.11 b/g standard	2.4 GHz
Frequency Range	2412-2462 MHz
WLAN channels (Wifi Client, Access Point)	1-11
Max Output Power	19 dBm (802.11 b) / 18 dBm (802.11 g)

Power

Switch-mode power supply	Autorange 100-240 V, (50/60 Hz)
Power consumption	30 W

Physical

Standard operating temperature range	5°C – 40°C (41°F – 104°F)
Dimensions	333 (W) x 149 (D) x 95 (H) mm, (13.1 x 5.9 x 3.7")
Weight	2.9 kg (6.4 lbs)

* including all channel and bus processing, excluding insert effects

MR12

12-Input Digital Mixer for iPad/Android
Tablets with 4 MIDAS PRO Preamps,
8 Line Inputs, Integrated Wifi Module and
USB Stereo Recorder

Architecture & Engineering Specifications

The MR12 shall be an 12-input digital audio mixer intended for remote control via iPad/Android/PC mobile applications

The product shall have 4 MIDAS PRO microphone preamplifiers with Neutrik latching XLR/TRS-combo connectors

The product shall provide a CD-quality stereo recorder/player for WAV media files on attached USB drives

The product shall have 2 auxiliary TRS outputs plus main Left and Right outputs on Neutrik XLR connectors

The product shall include an integrated WLAN/LAN Module for networked remote control

The product shall provide automatic mixing and gain sharing for all input channels

The product shall include 4 integrated digital effects processors

The product shall be using 40-bit floating point digital signal processing at 44.1 or 48 kHz sample rates

The product shall include rubber protection bumpers and 19" rack adaptors

The processing shall provide dynamics processing plus 6-band parametric or 31-band graphic equalisers on all Main Left/Right and the 6 aux buses/groups

The product shall be operated via free iOS, Android and PC/Mac*/Linux* apps available for remote operation via Ethernet, LAN or WiFi

The product shall have a detachable 2.4 GHz antenna on the front panel

The product shall have a MIDI In and Out for controlling the mixer via MIDI equipment

The product shall provide a stereo phones output on TRS jack socket with dedicated front panel level control for monitoring

The product shall be fitted with an internal auto-ranging switch mode power supply, capable of operation at AC voltages ranging from 100 to 240 VAC, at 50/60Hz

The mains connector shall be a standard IEC receptacle

The MR12 shall be 331 mm wide x 149 mm deep x 95 mm high (13.1" x 5.9" x 3.7"), with nominal weight 2.9 kg (6.4 lbs)

The product shall be the MIDAS MR12 and no other alternative shall be acceptable

MR12

12-Input Digital Mixer for iPad/Android
Tablets with 4 MIDAS PRO Preamps,
8 Line Inputs, Integrated Wifi Module and
USB Stereo Recorder



Digital Mixers

MR12

12-Input Digital Mixer for iPad/Android
Tablets with 4 MIDAS PRO Preamps,
8 Line Inputs, Integrated Wifi Module and
USB Stereo Recorder



MR12

12-Input Digital Mixer for iPad/Android
Tablets with 4 MIDAS PRO Preamps,
8 Line Inputs, Integrated Wifi Module and
USB Stereo Recorder



MR12

12-Input Digital Mixer for iPad/Android
Tablets with 4 MIDAS PRO Preamps,
8 Line Inputs, Integrated Wifi Module and
USB Stereo Recorder



Digital Mixers

MR12

12-Input Digital Mixer for iPad/Android
Tablets with 4 MIDAS PRO Preamps,
8 Line Inputs, Integrated Wifi Module and
USB Stereo Recorder



For service, support or more information contact the MIDAS location nearest you:

Europe
MUSIC Group Services UK
Tel: +44 156 273 2290
Email: CARE@music-group.com

USA/Canada
MUSIC Group Services NV Inc.
Tel: +1 702 800 8290
Email: CARE@music-group.com

Japan
MUSIC Group Services JP K.K.
Tel: +81 3 6231 0454
Email: CARE@music-group.com

MUSIC Group accepts no liability for any loss which may be suffered by any person who relies either wholly or in part upon any description, photograph, or statement contained herein. Technical specifications, appearances and other information are subject to change without notice. All trademarks are the property of their respective owners. MIDAS, KLARK TEKNIK, LAB GRUPPEN, LAKE, TANNOY, TURBOSOUND, TC ELECTRONIC, TC HELICON, BEHRINGER, BUGERA and DDA are trademarks or registered trademarks of MUSIC Group IP Ltd.
© MUSIC Group IP Ltd. 2017 All rights reserved.

