

Video Conference PTZ Joystick Controller

USER INSTRUCTION

USE/INSTALLATION

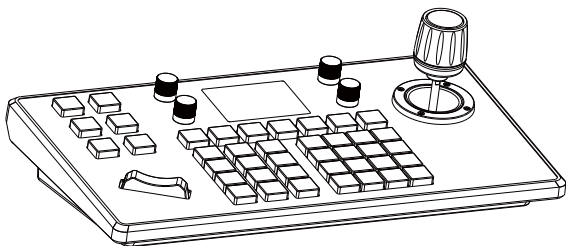

Preface

Thank you very much for purchasing our products. Please be free to contact us if there is any questions or requirements. The purpose of this manual is to ensure that the user can use the product correctly to avoid danger or property damage during operation. Before using this product, please read the this manual carefully and keep it for future reference.

Declaration

The contents described in this manual may be different from the current version you used.If you have any questions,please do not hesitate to contact us to get technical support.

This user manual will be updated from time to time and we reserves the right without notice.

1. Product Overview	01
1.1. Product Description	01
1.2. Product Features	01
2. Product Interface Description	01
2.1. Product Connection Diagram	02
2.1.1. Network Connection	02
2.1.2. RS485 Connection	03
2.1.3. Analog Mode-Control video conference camera via RS422	03
2.1.4. Connection Between Cameras	04
3. Button Function Description	05
3.1. Function Button Description	05
3.2. Joystick & Knob Description	08
4. Installtion & Setup	08
4.1. Add Network Device	08
4.2. Add Analog Device	09
5. Inquiry & Control	09
6. Network Configuration	10
6.1. Home Connection & Login	10
6.2. WEB Interface Setup	12
6.3. System Upgrade	12
6.4. System Reset	13
6.5. Restart	13
6.6. Import Configuration	13
6.7. Export Configuration	14
6.8. Version Information	14
7. FAQ	15

1. Product Overview

1.1 Product Description

This video conference ptz joystick is made of sheet metal and scratch-resistant PC matte film, and the aluminum die-casting surface design with a powder-bottomed bottom shell. The appearance is simple and beautiful. Adopt the industrial-grade LCD panel excellent display and the characters are delicate and clear. It supports VISCA, ONVIF protocols, and VISCA is fully compatible and extensible. Built in web server makes the configuration interface simple and clear, easy to operate. It only takes few steps to achieve perfect control of the video conferencing camera.

1.2 Product Features

- (1) Support network and analog two control modes, have independent IP addresses in network mode.
- (2) Support VISCA, VISCA over IP, Onvif, PELCO-P, PELCO-D protocols, and VISCA is fully compatible.
- (3) Support software function control of conference cameras.
- (4) Adopt high-quality variable speed 4D joystick control, comfortable operations. Rotate the joystick and control the conference camera omnidirectional movements.
- (5) Adopt addable seesaw to adjust the camera focus, operation is convenient and powerful.
- (6) Support IE browser to add camera configuration parameters.
- (7) Support up to 7 cameras shortcut control buttons for quick and easy operation.
- (8) Support standard POE power supply.

2. Product Interface Description

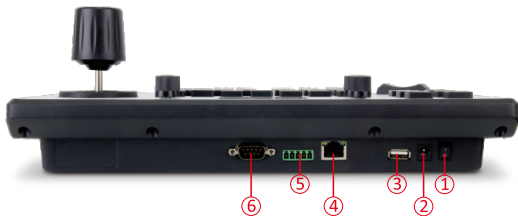

Corresponding function introduction

Number	Name	Function
1	POWER	Power switch
2	DC12V	Power interface, standard 5.5/2.1 power interface DC 12V2A±10%
3	USB	Using for joystick upgrading
4	Ethernet	Network interface, connect RJ45 for controlling
5	RS422	Support VISCA with full compatibility
6	RS232	Support PELCO

2.1 Product Connection Diagram

2.1.1 Network Connection

(1) Network Mode: Network VISCA, ONVIF Control PTZ Camera Connection Diagram

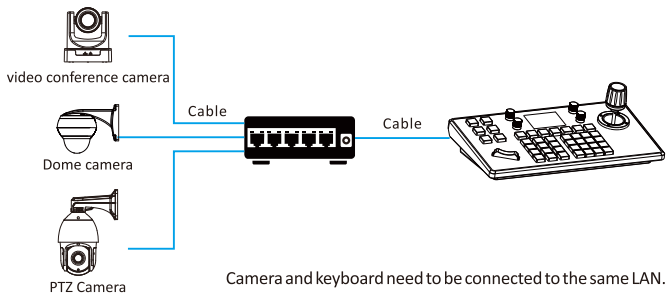

Connect the camera and joystick controller in the same LAN and ensure their IP address in the same network segment. Such as 192.168.1.123 & 192.168.1.111 belong to the same network segment, while 192.168.1.123 & 192.168.0.125 do not belong to the same network segment, then you need to modify the joystick controller or the ptz camera ip address at this time. The joystick controller get its IP address dynamically.

2.1.2 RS485 Connection

Analog Mode: Control Common PTZ Camera Via RS485 Connection Diagram

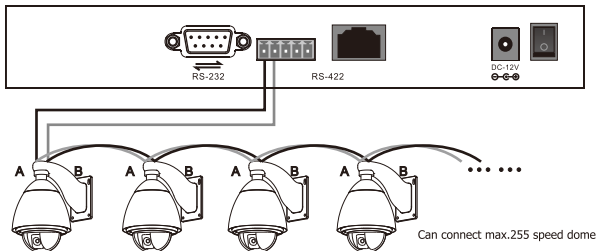

Control Output: RS485+ of PTZ camera connect to Ta of joystick controller & RS485- of PTZ Camera Connect to Tb of Joystick controller.

2.1.3 Analog Mode: Control Video Conference PTZ Camera Via

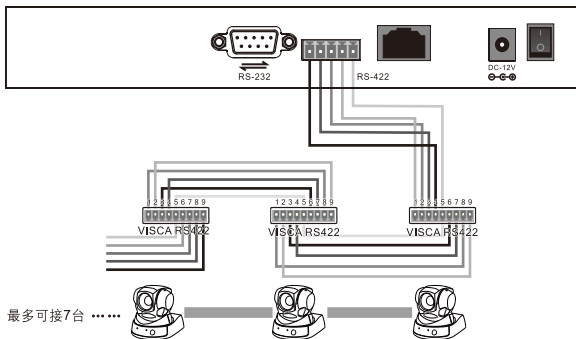

- (1) Using RS422 bus connection method, the third pin Ra of the joystick controller connect to TXD IN- of the camera, the fourth pin Rb of the joystick controller connect to TXD IN + of the camera, and the first pin Ta of the joystick controller connect to RXD IN- of the camera, the second pin Tb of the joystick controller connect to RXD IN- of the camera.

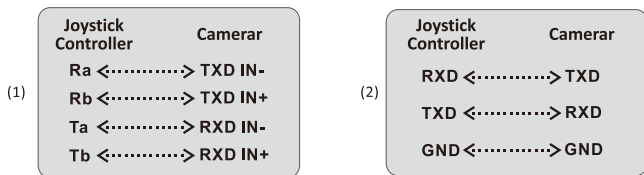

(2) Using RS232 connection method. The first pin RXD of joystick controller(10pin terminal) connect to the input interface TXD of camera, the second pin TXD of joystick controller connect to RXD of camera, the third pin of joystick controller connect to GND of camera(also can use the standard RS232 interface(DB0) of joystick controller to connect the camera.)

2.1.4 Connection Between Cameras

Using RS422 bus cascade connection method. The output of camera #1 connect to the input of camera #2 and the output of camera #2 connect to the input of camera #3 and so on like below:

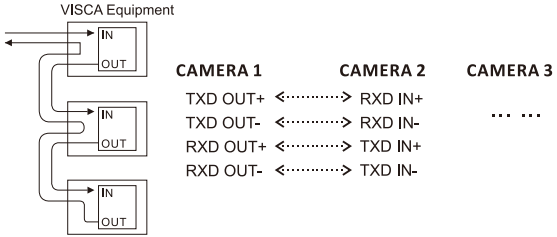

Using RS232 cascade connection almost the same as RS422. The output of camera #1 connect to the input of camera #2 and the output of camera #2 connect to the input of camera #3 and so on:

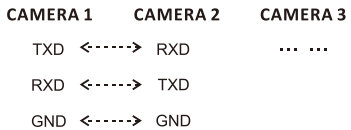

3. Button Function Description

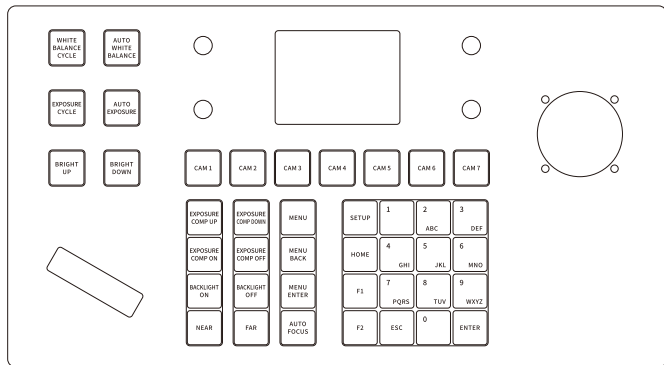

3.1 Function Button Description

[WHITE BALANCE CYCLE] Auto white balance: Click the button to enter the reuse function: the indoor white balance/outdoor white balance/manual white balance/one-button white balance mode.

[AUTO WHITE BALANCE] Auto white balance: Click the button to select the white balance setting.

[EXPOSURE] Auto Exposure: Increase the exposure of the video screen, click the button to enter the manual exposure / brightness priority.

[AUTO EXPOSURE] Auto exposure: Click the button to enter the automatic exposure adjustment mode.

[BRIGHT UP] Brightness+: Click the button to increase the screen brightness setting.

[BRIGHT DOWN] Brightness -: Click the button to down the screen brightness setting.

[EXPOSURE COMP UP] Exposure compensation level+: Click the button the device screen will increase changes according to the exposure compensation level.

[EXPOSURE COMP DOWN] Exposure compensation level-: Click the button the device screen will decrease changes according to the exposure compensation level.

[EXPOSURE COMP ON] Exposure compensation ON: Click the button to turn on the exposure compensation setting.

[EXPOSURE COMP OFF] Exposure compensation OFF: Click the button to turn off the exposure compensation setting.

[BACKLIGHT ON] Backlight ON: Click the button to set the screen brightness gain.

[BACKLIGHT OFF] Backlight OFF: Click the button to set the screen brightness to the initial value display state..

[NEAR]Near: After pressing **[NEAR]** button,screen will make the nearby objects clearer.Long press will change the focus of the screen to be close focus.

[FAR] Far: After pressing **[FAR]** button,screen will make the distant objects clearer. Long press will change the focus of the screen to be far focus.

[MENU] Camera menu: Click the button will appear the the camera menu setting.
(for conference ptz camera)

[MENU BACK] Camera menu back: Click the button to back to the previous level after entering the menu to set the parameters,one by one to back to the main menu incrementally.(for conference ptz camera)

[MENU ENTER] Camera menu confirmation: Click the button to enter the menu of each item for related setting.(for conference ptz camera)

[AUTO FOCUS] Auto focus: Click the button to set the camera focus on the object automatically.

[SETUP] Menu setup: Click the button to enter the joystick controller parameters setting and devices addition.

Joystick Controller Setting	Decription	
1. Add Network Devices	Camera	Serial number of the camera,can input 1-7; After adding all camera information, press[Enter] button to save.
	Protocol	Optional: VISCA(UDP), SONY VISCA(UDP), VISCA(TCP), ONVIF, Select the protocol corresponding to the camera
	IP address	Camera ip address
	Port	Input the camera port number
	User name Password	Input the correct user name and passord corresponding to each camera.

2. Add Analog Device	Camera	Serial number of the camera,can input 1-7; After adding all camera information, press[Enter] button to save.
	Protocol	Select the protocol corresponding to the camera
	Address Code	Select the address code corresponding to the camera
	Baud rate	Select the baud rate corresponding to the camera
3. Device List	Added camera list, you can use the joystick to switch up and down, you can press the button on the top of joystick or press [Enter] button to confirm the control.	
4. Network properties: static/dynamic	Network properties:	Switch via joystick left and right, press [Enter] button to confirm.
	Dynamic	Dynamic allocation based on switch settings
	Static	Need to fill in IP, gateway, subnet mask, make sure the same network segment as the camera.
5. Lanuage: EN/CN	Switch via joystick left and right, press[Enter] button to cofnirm.	
6. Beeps: ON/OFF	Switch via joystick left and right, press[Enter] button to cofnirm.	
7. Reset	Double-click [ENTER] to enter reset [ESC] to cancel	
8. System Information	Chenk Joystick Controller software, hardware, web version, gateway and subnet mask information.	

[HOME] This button function is the origin of the camera.

[F1][F2] Buttons for development.

[0-9] Numeric key presets: Long press for preset setting while short press for preset calling.

For Example: Set preset #1

First move the camera to the position where you want to set the preset , long press the number [1], “PRESET 1” will appear at the bottom of the screen, then move the camera to another position, short press the number [1] to call and it will turn to preset#1 position which you set.

[ESC] Escape







[ENTER] Confirmation

[CAM1] [CAM2] [CAM3] [CAM4] [CAM5] [CAM6] [CAM7]

Click the button to enter the corresponding device control function.

- Mark: 1.Click the address code to switch the camera quickly.
2.Each CAM enjoys network mode and analogue mode.

3.2 Joystick & Knob Description

Operating	Output Control	Operating	Output Control	Operating	Output Control
	Upward		Downward		Left
Operating	Output Control	Operating	Output Control	Operating	Output Control
	Right		Zoom +		Zoom -

Press the middle joystick button to confirm in menu mode

(1) ZOOM SPEED/PT SPEED Zoom speed/ Control speed:

turn the knob to the right+, to the left -. Press the knob to switch the speed type.

(2) IRIS Iris, turn the knob to the right+, to the left -. Press the knob no function.

(3) RGAIN/BGAIN Red-blue gain, turn the knob to the right+, to the left -. Press the knob to switch the gain type.

(4) NAR/FAR Focus, turn the knob to the right+, to the left-. Press the knob no function.

(5) Joystick clockwise / joystick counterclockwise: Zoom + / Zoom -.

(6) Addable seesaw: T zoom +; W zoom -.

4. Installation & Setup

4.1 Add Network Device

Use the joystick controller to add a LAN device as follows

1. Click [SETUP] button to enter the main menu;

Keyboard Settings

- > 1. Add Network Device
2. Add Analog Device
3. Device List
4. Network Attribute: Static
5. Language: English
6. Button Tone: Off
7. Restore Factory
8. System Info



2. Click to add a network device, input the camera ip address and then input its protocol and port number, press [Enter] to confirm.



3. Enter Device List and select the device which you want to be added through joystick "UP" & "DOWN" press the button on the top of joystick or press [Enter] to control.

4.2 Add Analog Device

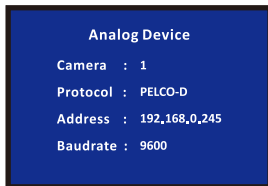
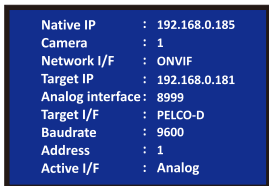

1. Long press the button on the top of joystick to switch the mode into analog mode.
2. Press [SETUP] button to enter setting interface and select adding analog device.
3. Enter the device add interface, select #1-#7 camera, select the protocol corresponding to the camera, select the address code and baud rate, press [Enter] to confirm addition.

5. Inquiry & Control

1. On the main menu interface, press [SETUP] button to enter setting interface, select Device List through joystick up and down and press [Enter] button to view the added devices.

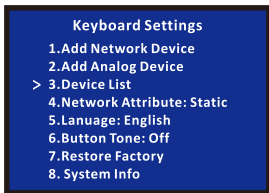

2. Through joystick up and down to check saved devices , press the button on the top of joystick or [Enter] to select the camera you want to control.
3. When the scree shows the connection is successful,which means the joystick controller has been connected to this ip device. At this time you can control the PTZ, zoom, preset setting,etc.

6. Network Configuration

6.1 Home Connection & Login

Well connect the joystick controller power cable and connect the network cable.After the joystick controller startup is completed, it will display its ip address: 192.168.x.xxx on screen. Enter this IP address to the browser to access the page configuration. The initial user name:admin; password:empty.

- (1) Connect the joystick controller and computer to the same LAN, enter the joystick controller IP address to the browser. The page display as follows:



2.Default user name: admin; password: empty

3.Enter device web interface, the page display as follows:

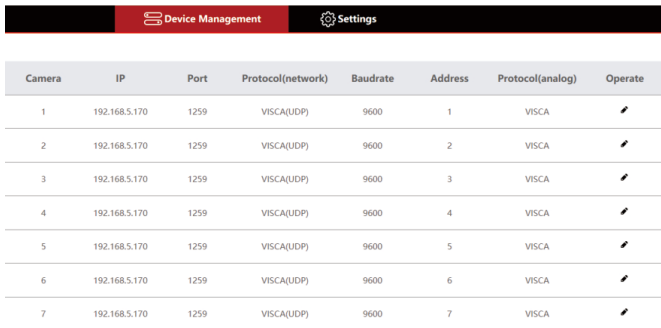

The screenshot shows a web interface with a black header bar. On the left, there is a red button labeled 'Device Management' with a camera icon. On the right, there is a gear icon labeled 'Settings'. Below the header is a table with 8 columns: Camera, IP, Port, Protocol(network), Baudrate, Address, Protocol(analog), and Operate. The table contains 7 rows of data, each representing a camera configuration. The 'Operate' column contains a pencil icon for each row.

Camera	IP	Port	Protocol(network)	Baudrate	Address	Protocol(analog)	Operate
1	192.168.5.170	1259	VISCA(UDP)	9600	1	VISCA	
2	192.168.5.170	1259	VISCA(UDP)	9600	2	VISCA	
3	192.168.5.170	1259	VISCA(UDP)	9600	3	VISCA	
4	192.168.5.170	1259	VISCA(UDP)	9600	4	VISCA	
5	192.168.5.170	1259	VISCA(UDP)	9600	5	VISCA	
6	192.168.5.170	1259	VISCA(UDP)	9600	6	VISCA	
7	192.168.5.170	1259	VISCA(UDP)	9600	7	VISCA	

4. After entering the device homepage, you can view the details of the device parameters, which can be changed.

5. Click " "to add and modify the device parameters in the LAN, the page display as follows:

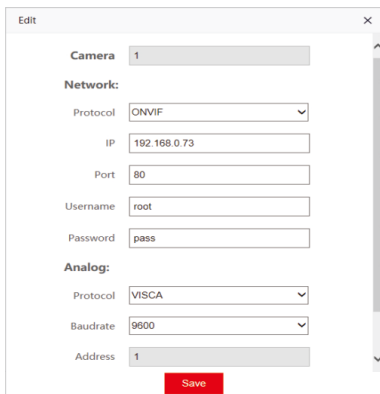

The screenshot shows a web form titled 'Edit' with a close button (X) in the top right corner. The form is divided into several sections: 'Camera' with a text input field containing '1'; 'Network:' section with a 'Protocol' dropdown menu set to 'ONVIF', an 'IP' text input field containing '192.168.0.73', a 'Port' text input field containing '80', a 'Username' text input field containing 'root', and a 'Password' text input field containing 'pass'; 'Analog:' section with a 'Protocol' dropdown menu set to 'VISCA', a 'Baudrate' dropdown menu set to '9600', and an 'Address' text input field containing '1'. At the bottom of the form is a red 'Save' button.

(Input the device number, corresponding IP address, port number and user name and click save.

Note:

When entering the joystick controller web interface to add a device successfully, which is synchronized with the joystick controller. After adding the device on the web interface successfully, click the joystick controller corresponding number to control the camera.

6.2 WEB Interface Setup

Network settings can modify the device's IP acquisition method and port parameters, as shown below:

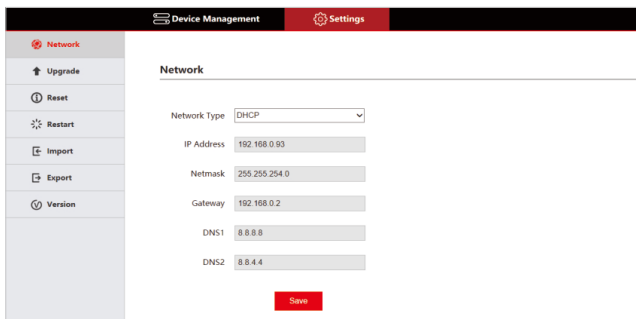

The screenshot shows the 'Network' settings page. The top navigation bar includes 'Device Management' and 'Settings'. The left sidebar contains options: Network (selected), Upgrade, Reset, Restart, Import, Export, and Version. The main content area is titled 'Network' and contains the following fields:

Network Type	DHCP
IP Address	192.168.0.93
Netmask	255.255.254.0
Gateway	192.168.0.2
DNS1	8.8.8.8
DNS2	8.8.4.4

A red 'Save' button is located at the bottom right of the form.

Dynamic Address(DHCP)(Default acquisition method):The joystick controller will request an IP address from the router automatically. After the request is successful, it will be displayed on the joystick controller's display. The display format is: "Local IP: 192.168.x.xxx".

Static Address (STATIC):When the user wants to set the network segment by himself, modify the network type to a static address and fill in the information of the network segment that requires to be modified.

6.3 System Upgrade

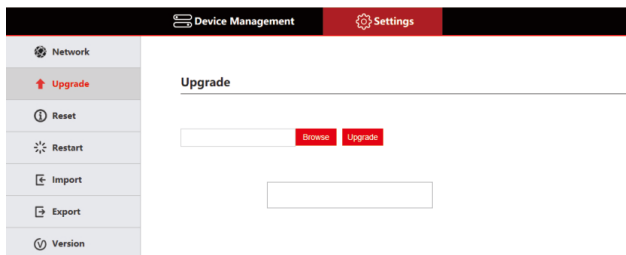

The screenshot shows the 'Upgrade' page. The top navigation bar includes 'Device Management' and 'Settings'. The left sidebar contains options: Network, Upgrade (selected), Reset, Restart, Import, Export, and Version. The main content area is titled 'Upgrade' and contains the following elements:

A text input field with a red 'Browse' button and a red 'Upgrade' button.

A large empty text input field below the first one.

Upgrade function is used as the maintenance and update joystick function. After entering the upgrade page, select the correct upgrade file and click "Start". The device will automatically restart after the upgrade is completed.

Note: Do not perform any operations against the device during its upgrade process, and do not power off or disconnect the network!

6.4 System Reset

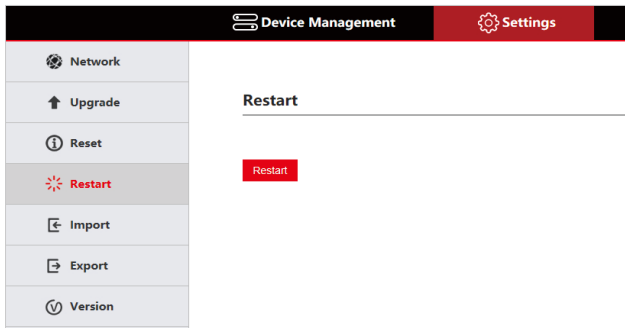

When click the device to reset, the joystick controller will remove all data, and the network will automatically default to a static IP. Recommended caution operation.

6.5 Restart

After the device is used for a long time, you need to restart it for maintenance. Click Restart is OK.

6.6 Import Configuration

Import the previous joystick controller device information, (for example, when you added multi-channel device to the previous joystick controller, export the file type and use it as an import to another device when adding a new joystick controller.)

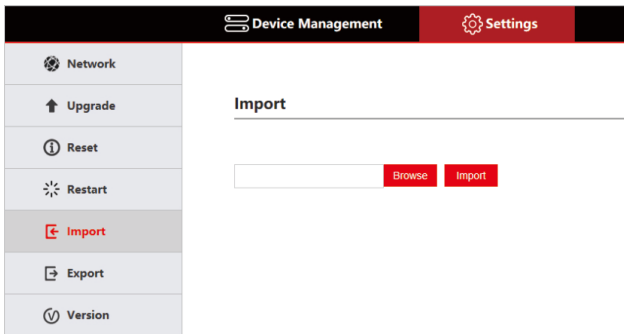

6.7 Export Configuration

Export the related information about the current joystick controller added multiple devices, which can be exported to other joystick controller for use.

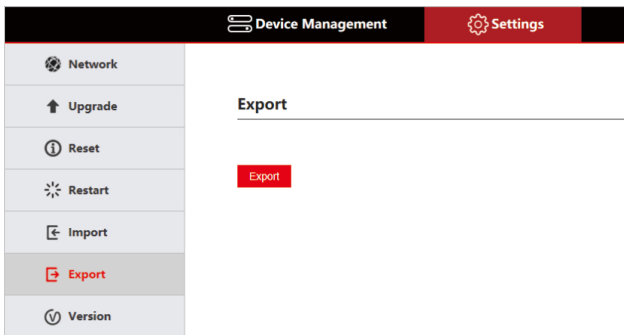

6.8 Version Information

Display the current joystick controller software and hardware information.

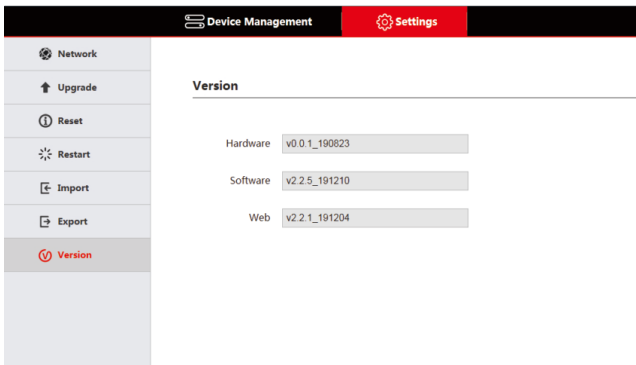

7. FQA

1. When the screen displays "Connection failed", please check the device corresponding to this IP address is normally connected in the LAN.
2. When adding other brand device fails, please check its ONVIF protocol is turned on or not.

Note:

- (1) Add device for manual addition
- (2) Enter the correct port number and device connection protocol in Add Device.

