

DesignMax DM8S

surface-mounted loudspeaker

Product Overview

DesignMax loudspeakers bring outstanding audio and aesthetics to any commercial space. Delivering SPL suitable for foreground music, the 125-watt DesignMax DM8S loudspeaker features a two-way, 8-inch coaxially mounted woofer and a center-firing 1-inch compression driver, delivering a 52 Hz - 20 kHz frequency range. The DM8S is surface-mounted and locks onto a hidden QuickHold U-bracket for fast, secure installation. With both black and white versions available, the DM8S is easy to integrate with any décor.



Key Features

Deliver instantly impressive sound with custom Bose drivers — no DSP or EQ required. For even better sound, use select Bose DSPs and amplifiers to enable Bose loudspeaker EQ and SmartBass processing, which expands performance and response at any listening level

Blend into any room design with elegant form factors, minimum-bezel grilles available in black or white, and removable logos

Reduce installation time with the patented QuickHold mounting system, which also reduces strain, hassle, and the chance of product damage

Install easily — includes Euroblock connectors; makes installation and troubleshooting easier

Deliver high SPL for clear foreground music

Technical Specifications

SINGLE LOUDSPEAKER PERFORMANCE		
Frequency Response (-3 dB) ⁽¹⁾	60 - 20,000 Hz	
Frequency Range (-10 dB) ⁽¹⁾	52 - 20,000 Hz	
Nominal Coverage Angle (H x V) ⁽²⁾	130° x 130°	
Nominal Coverage Angle (1 - 10 kHz)	115° x 115°	
	Bose extended-lifecycle test ⁽⁵⁾	AES component test ⁽⁶⁾
Power Handling, long-term continuous	125 W	150 W
Power Handling, peak	500 W	600 W
Sensitivity (SPL/1W @ 1 m) ⁽³⁾	90 dB	90 dB
Calculated Maximum SPL @ 1 m ⁽⁴⁾	111 dB	112 dB
Calculated Maximum SPL @ 1 m, peak	117 dB	118 dB
Crossover	1.5 kHz (passive 2-way crossover)	
Loudspeaker EQ	Not Required, Bose EQ voicing and SmartBass processing available	
Recommended High-Pass Protection	48 kHz with recommended 24 dB / octave filter	
Overload protection	Resistor-network power reduction with automatic reset	
Transformer taps	70V: 2.5, 5, 10, 20, 40, 80 W, bypass 100V: 5, 10, 20, 40, 80 W, bypass	
TRANSDUCERS		
Low Frequency	1 x 8-inch woofer (203 mm)	
High Frequency	1 x 1-inch compression driver, coaxial center-firing (25 mm)	
Nominal Impedance	8 ohms (transformer bypass)	

DesignMax DM8S

surface-mounted loudspeaker

PHYSICAL	
Enclosure Material	Engineered plastics, highly UV fade resistant
Bracket Material	Powder-coated steel
Grille	Magnetically attached perforated steel, powder-coated finish, paintable, tamper-resistant design, includes safety-tether
Logo	Rotatable, removable
Color	Black: Ral 9005, White: Bose Arctic White, similar to RAL 9003, Paintable
Environmental	Indoor only
Safety Agency	UL-1480A, S5591/ UL Listed, NFPA70, in accordance with IEC60268-5, ROHS, CE compliant
Operating Temperature Range	0 °C to 50 °C (32 °F to 122 °F)
Connectors	Euroblock 6-pin connector with loop-through, mounted on rear. Accepts 18 AWG (0.8 mm ²) to 14 AWG (2.5 mm ²) size wire
Suspension / Mounting	QuickHold Mounting System with included U-Bracket
	4 preset mounting angles: 0°, 15°, 30°, 45° for wall or ceiling placement
	Two (2) rear M8 screw inserts for use with optional pan & tilt bracket and one (1) rear M8 screw insert for safety-tether attachment
Dimensions (H x W x D)	395 x 249 x 253 mm (15.6 x 9.8 x 10 in)
Dimensions (H x W x D) with bracket	395 x 249 x 270 mm (15.6 x 9.8 x 10.7 in)
Net Weight, Loudspeaker with grille	10.3 kg (22.8 lbs)
Shipping Weight, Single	13.2 kg (29.0 lb)
Included Accessories	U-Bracket, powder-coated steel
Optional Accessories	Pan & Tilt Bracket
PRODUCT CODES	
801332-0110	DESIGNMAX DM8S SINGLE BLK
801332-0210	DESIGNMAX DM8S SINGLE WHT

Footnotes

- (1) Frequency response and range measured on-axis in half-space environment with Bose EQ voicing
- (2) 1 kHz to 4 kHz average
- (3) Sensitivity measured on-axis in half-space environment with Bose EQ voicing
- (4) Maximum SPL calculated from sensitivity and power handling specifications, exclusive of power compression.
- (5) Bose extended-lifecycle test using pink noise filtered to meet IEC268-5, 6-dB crest factor, 500-hour duration.
- (6) AES standard 2-hour duration with IEC system noise

For additional specifications and application information, please visit PRO.BOSE.COM.
 Specifications subject to change without notice. 11/2019

DesignMax DM8S

surface-mounted loudspeaker

On-Axis Frequency Response (half-space (2π) with Bose EQ voicing)

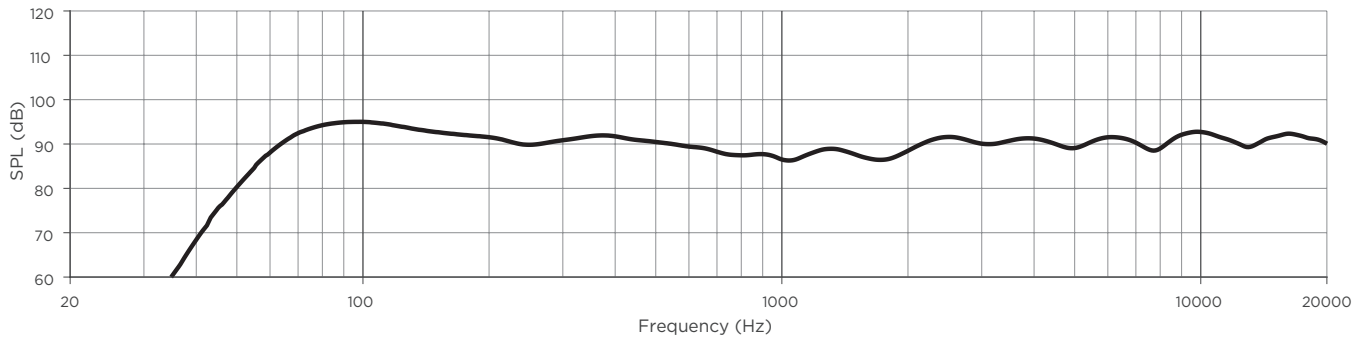

Impedance

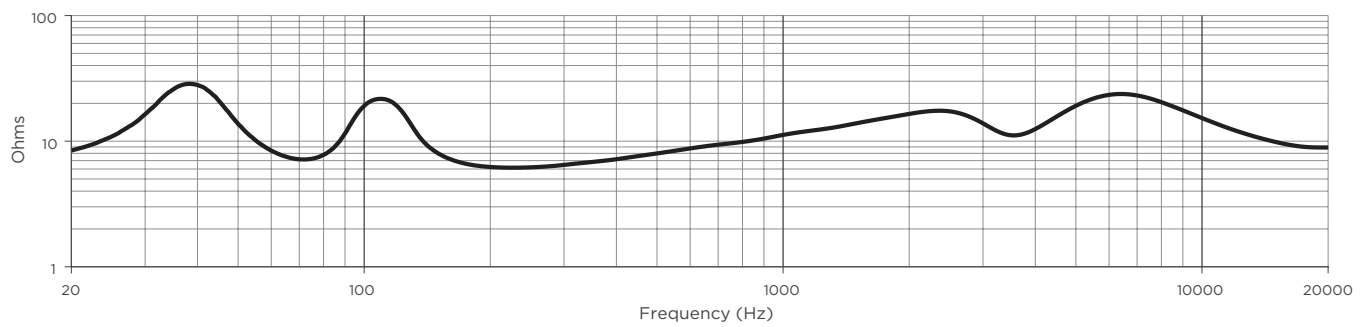

Beamwidth

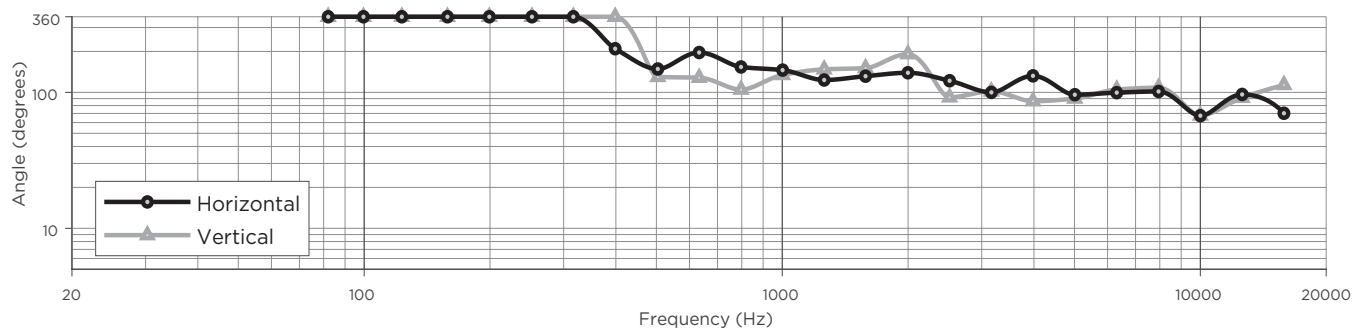

DesignMax DM8S

surface-mounted loudspeaker

Dimensions



Top View

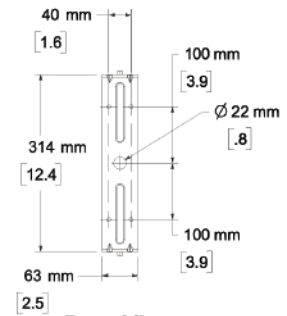

Rear View
BRACKET ONLY

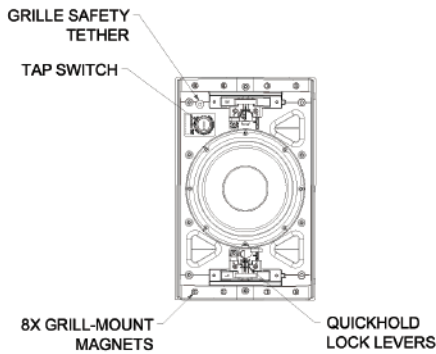

Front View
GRILLE REMOVED FOR CLARITY

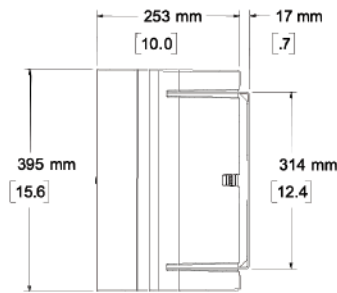

Right View
DIMENSIONS APPLY TO BOTH SIDES

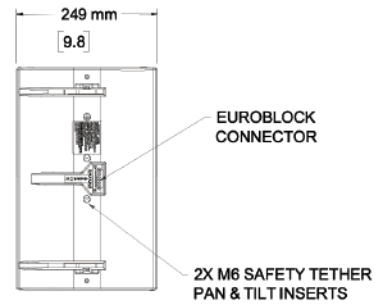

Rear View
BRACKET REMOVED FOR CLARITY

- NOTES:
1. DIMENSIONS ARE IN MILLIMETERS OVER INCHES
 2. WEIGHT 10.3kg [22.8lbs] (SPEAKER ONLY)
 3. WEIGHT W/BRACKET 11.3kg [24.9lbs]