



# BPHS2/BPHS2C/BPHS2S

## User Manual

Broadcast Stereo Headset with Dynamic Boom Microphone /  
Broadcast Stereo Headset with Condenser Boom Microphone /  
Single-Ear Broadcast Headset with Dynamic Boom Microphone

audio-technica

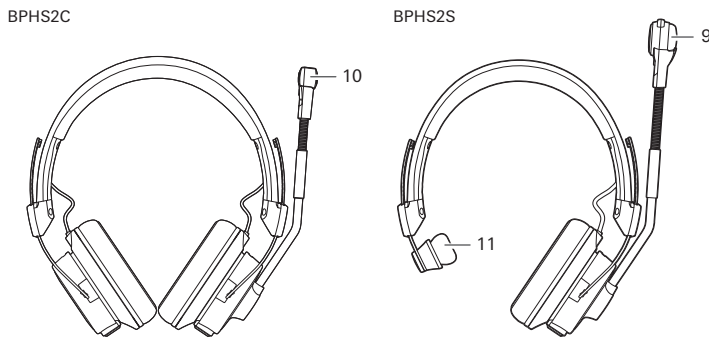
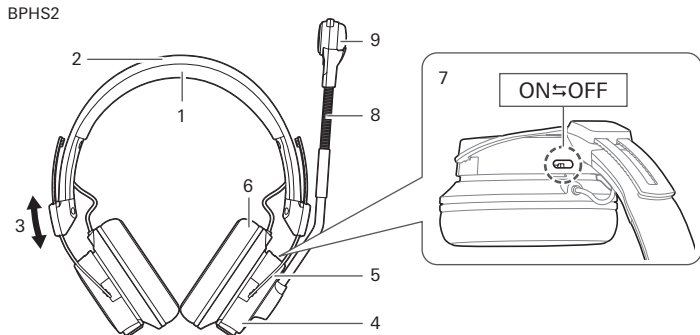

### Part names

Refer to the figures and confirm the parts of the headphones before use.

- |            |                              |
|------------|------------------------------|
| 1 Head pad | 7 Limiter switch             |
| 2 Headband | 8 Gooseneck                  |
| 3 Slider   | 9 Dynamic boom microphone    |
| 4 Housing  | 10 Condenser boom microphone |
| 5 Arm      | 11 Temple pad                |
| 6 Earpad   |                              |

### Cleaning the product

Get into the habit of regularly cleaning the product to ensure that it will last for a long time. Do not use alcohol, paint thinners or other solvents for cleaning purposes.

- To clean, wipe the main unit with a dry cloth.
- Wipe away perspiration and any other dirt from the cable with a dry cloth immediately after use. Failure to clean the cable may cause it to deteriorate and harden over time, resulting in malfunction.
- Wipe the plug with a dry cloth if dirty. Failure to clean the plug may cause the sound to cut out and may cause noise.
- Wipe the earpads and head pad with a dry cloth if dirty. Perspiration or water on the earpads or head pad may cause discoloration. Wipe with a dry cloth and allow to dry in the shade.

- If the product will not be used for an extended period of time, store it in a well-ventilated place free from high temperatures and humidity.
- The earpads, head pad, and temple pad are consumable items. They will deteriorate over time due to use and storage, so replace them when necessary. For information about replacing earpads, head pad, or other parts, or for information about other serviceable parts, contact your local Audio-Technica dealer.

### Using the product

You can use the microphone on the left or right side of your face by rotating the microphone boom as shown in the figure.

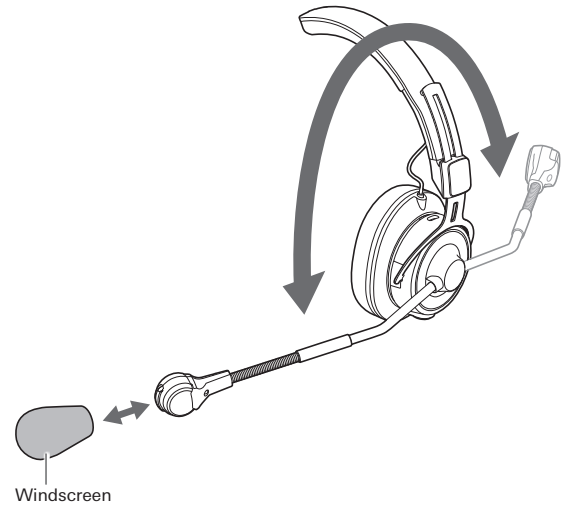

### Positioning the microphone boom

Use the microphone boom and gooseneck to place the microphone in the correct position.

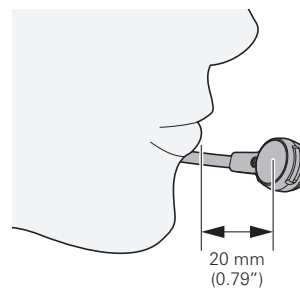
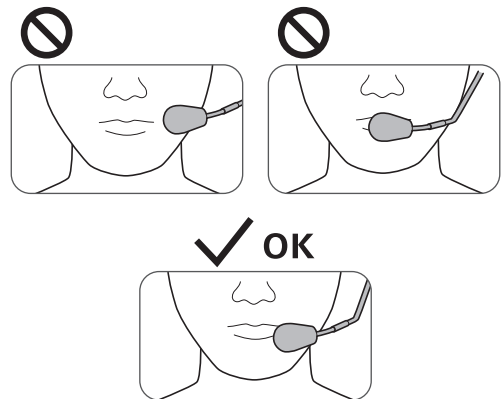

Position the microphone boom so that the microphone is about 20 mm (0.79") from the tip of your mouth. Positioning the microphone directly in front of your mouth will cause popping and other noise from breathing.

### Using the limiter switch

Use a thin-tipped tool to slide the limiter switch as shown in the figure.

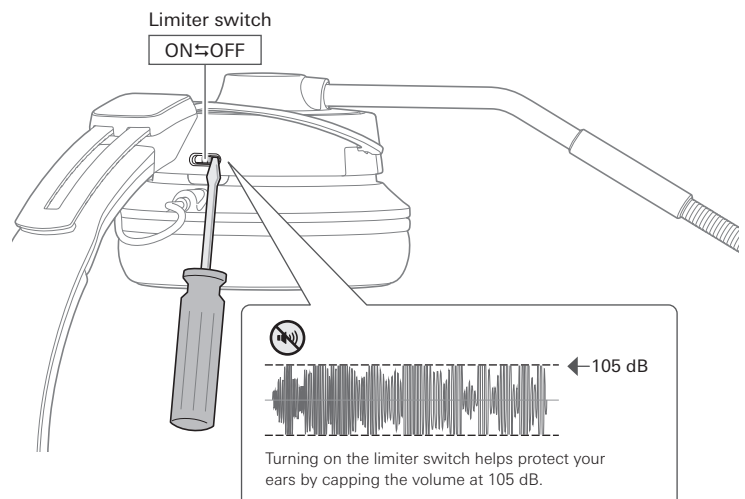

Turning on the limiter switch helps protect your ears by capping the volume at 105 dB.

## ■ Connecting the product

Connect cables such as BPCB2 (included) or BPCB3 (sold separately) to the connector jack of the product.

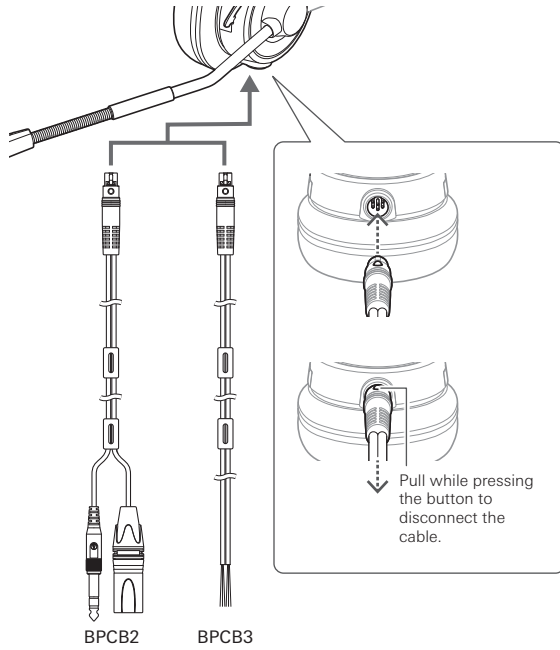

### ■ BPCB2

Cable for BPHS2 (all models) with a TA6F connector at one end and 3-pin XLRM connector and 6.3 mm (1/4") plug at the other.

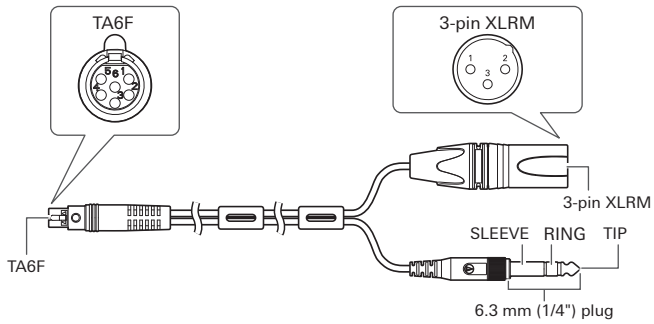

	Function	TA6F	3-pin XLRM	6.3 mm (1/4") plug
Microphone	MIC +	PIN 5	PIN 2 HOT	-
	MIC -	PIN 6	PIN 3 COLD	-
	SHIELD	PIN 1	PIN1 GND	-
Headphones	SPEAKER -	PIN 2	-	SLEEVE
	SPEAKER R+	PIN 4	-	RING
	SPEAKER L+	PIN 3	-	TIP

### ■ BPCB3

Cable for BPHS2 (all models) with a TA6F connector at one end and unterminated connector at the other.

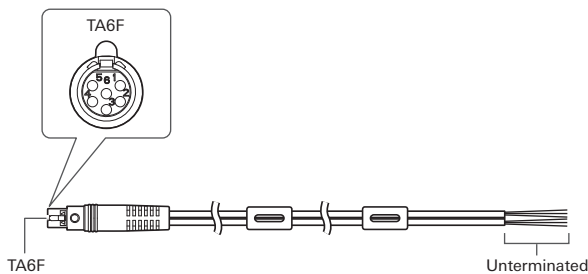

	Function	TA6F	Unterminated
Microphone	MIC +	PIN 5	RED
	MIC -	PIN 6	YELLOW
	SHIELD	PIN 1	COPPER
Headphones	SPEAKER -	PIN 2	BLACK
	SPEAKER R+	PIN 4	RED
	SPEAKER L+	PIN 3	GREEN

## Specifications

### Headphones

Type	Closed-back dynamic
Driver	Φ45 mm (1.77")
Sensitivity	102 dB/mW
Frequency response	15 to 28,000 Hz
Maximum output	1,600 mW
Impedance	38Ω (312Ω when limiter switch is on)
Input jack	TB6M jack
Weight (without cable)	BPHS2: 250 g (8.8 oz), BPHS2C: 240 g (8.5 oz), BPHS2S: 190 g (6.7 oz)
Accessories	Windscreen x 3, clip, pouch
Replacements/separately sold items	BPCB2 (3.0 m (9.8') / TA6F, 3-pin XLRM, plug), BPCB3 (3.0 m (9.8') / TA6F, unterminated), Earpad HP-M60x, Head pad

### Microphone

#### BPHS2/BPHS2S

Type	Dynamic
Polar pattern	Hypercardioid
Frequency response*	50 to 14,000 Hz (at 2 cm (0.79"))
Sensitivity*	-57 dB (1.4 mV) (0 dB = 1 V/Pa, 1 kHz)
Output impedance	550Ω
Dimensions	Height: 18.0 mm (0.71"), Main unit maximum diameter: 23.4 mm (0.92")
Output connector	TB6M

#### BPHS2C

Type	Back electret condenser
Polar pattern	Cardioid
Frequency response*	60 to 15,000 Hz (at 2 cm (0.79"))
Sensitivity*	-45 dB (5.6 mV) (0 dB = 1 V/Pa, 1 kHz)
Maximum input sound pressure level*	140 dB SPL (1 kHz THD1%)
S/N ratio*	60 dB (1 kHz at 1 Pa, A-weighted)
Dynamic range	106 dB (1 kHz at Max S.P.L.)
Phantom power	11 to 52V DC, 2 mA
Dimensions	Minimum width: 12 mm (0.47"), Height: 12.7 mm (0.5")
Output connector	TB6M

\*During a wired connection with the product. Performance varies depending on the device used.  
 • 1 Pascal = 10 dynes/cm<sup>2</sup> = 10 microbars = 94 dB SPL

For product improvement, the product is subject to modification without notice.

## Polar pattern/frequency response

### BPHS2/BPHS2S

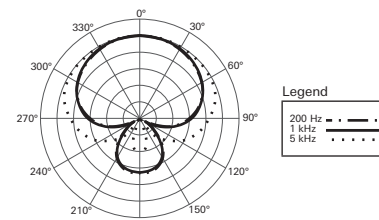

Sound pressure scale is 5 dB per unit

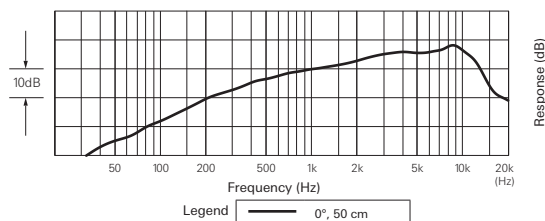
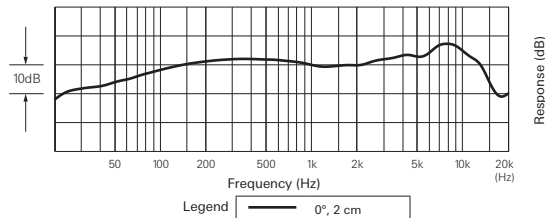

• During a wired connection with the product. Performance varies depending on the device used.

### BPHS2C

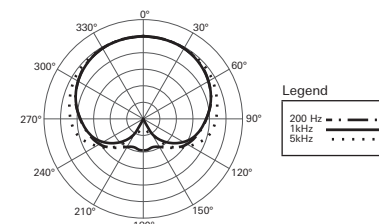

Sound pressure scale is 5 dB per unit

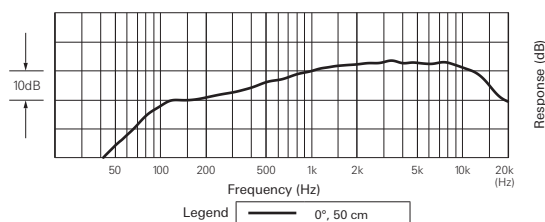
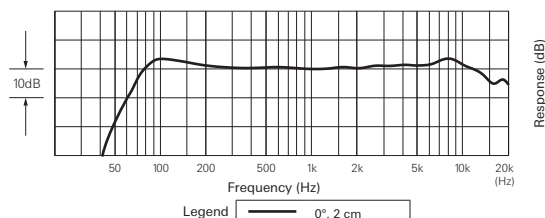

• During a wired connection with the product. Performance varies depending on the device used.

Audio-Technica Corporation

2-46-1 Nishi-naruse, Machida, Tokyo 194-8666, Japan

©2020 Audio-Technica Corporation

Global Support Contact: [www.at-globalsupport.com](http://www.at-globalsupport.com)

Made in Japan

142316130-02-02 ver.1 2018.08.01  
 ver.2 2020.02.15