

ATDM-0604

User Manual DIGITAL SMARTMIXER

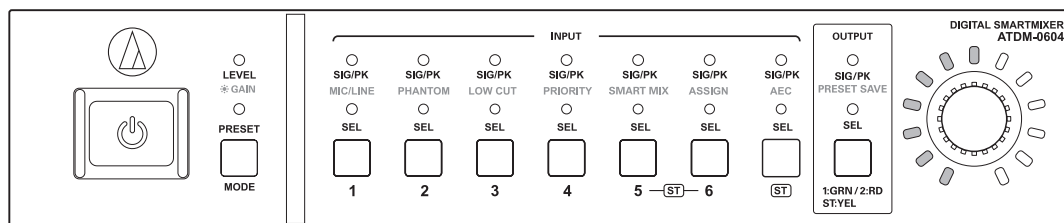

Contents

Introduction	3	Operator screen	21
Checking the package contents	3	Administrator screen	22
Trademarks	3	Header	22
Safety precautions	4	Indicators	23
Important information	4	How to view audio input and output screens	24
For customers in the USA/Canada	4	Setting the audio input details	25
Important safety instructions	4	Changing the input type (MIC/LINE)	25
FCC notice	5	Adjusting the gain	25
For customers in Canada	5	Turning the phantom power ON/OFF	25
Notes on use	6	Turning the phase ON/OFF	25
About the product	6	Turning the low-cut ON/OFF	25
Maintenance	6	Turning the 4-band EQ ON/OFF	25
Features	7	Adjusting the 4-band EQ	26
Features of ATDM-0604	7	Turning the AEC ON/OFF	27
About Audio-Technica LINK	7	Checking SmartMixer status	27
System installation	7	Turning the bus assignment ON/OFF	27
Installing on a rack	7	Setting channel names and colors	28
Unbalanced connection	9	Turning the mute ON/OFF	28
Power cable connection	9	Adjusting the input level	28
How to connect a Euroblock connector	9	Setting the audio output details	29
System connection examples	10	Setting the unity level	29
Local discussion (Preset #2)	10	Turning the FBS ON/OFF	29
Remote discussion - web conference (Preset #3)	10	Turning the EQ ON/OFF	29
Remote discussion - video conference (Preset #4)	11	Adjusting the FBS/EQ	29
Part names and function	12	Turning the dynamics function ON/OFF	32
Front panel	12	Adjusting the dynamics	32
Rear panel	13	Turning the delay function ON/OFF	34
Using the product	14	Setting the delay time for delay function	34
Starting the product	14	Setting channel names and colors	34
Front panel mode	14	Adjusting the output level	35
Changing the front panel mode (operator mode/advanced mode)	14	Setting the USB output	35
Selecting a function	14	Setting the system details (Settings & Maintenance)	36
Operations that can be performed in operator mode/advanced mode	15	Basic operations	36
Operations available only in advanced mode	15	Settings & Maintenance screen	36
Changing the IP config mode (Auto/Static)	16	General in System Settings	37
Locking the front panel	17	Network in System Settings	38
Checking the firmware version	17	User Access in System Settings	39
Web Remote	18	Audio in System Settings	40
What Is Web Remote?	18	Front Panel in System Settings	41
What is "Locate"?	18	Utilities in System Settings	42
Recommended environment	18	Operator Page in Operator Access	43
Preparing Web Remote	18	Presets in Presets	44
Overview of Web Remote	19	4 Band EQ Library in Presets	45
Launch/Log into Web Remote	20	12 Band EQ Library in Presets	46
Launching Web Remote	20	Logging in Logging	47
Login screen	20	System Info in System Info	48
Logging into Web Remote	20	Key functions	49
Logging out of Web Remote	20	AEC (Acoustic Echo Canceler)	49

Contents

SmartMixer	52
Audio-Technica LINK	55
Front panel operation restriction	58
Recalling Preset	59
About preset	60
Copying settings	63
Resetting settings	64
Linking channels	65
Using the ES954 (Hanging Microphone Array)	66
Ducking function	70
Menu Item	71
Audio Settings	71
Settings & Maintenance	75
Troubleshooting	77
ATDM-0604 unit	77
Web Remote	78
Error messages	79
Dimensions	80
Specifications	81
General specifications	81
Audio	81
Input/Output specifications	82
System diagram	83

Introduction

Thank you for purchasing this Audio-Technica product.

Before using the product, read through this user manual to ensure that you will use the product correctly. Please keep this manual for future reference.

Checking the package contents

Before use, check to make sure that all of the following items are contained in the package.

If any of the items is missing from your package or damaged, contact your local Audio-Technica dealer.

- ATDM-0604 unit
- Euroblock connector ×10
- Rack-mount (large, small)
- Rack-mount screw ×6
- Power cable
- Rubber feet ×4
- Quick Start Guide

Trademarks

- SMARTMIXER™ is a trademark or registered trademark of Audio-Technica Corporation.
- Apple and the Apple logo are trademarks of Apple Inc., registered in the U.S. and other countries.
- iOS is a trademark or registered trademark of Cisco in the U.S. and other countries.
- App Store is a service mark of Apple Inc.
- Google, the Google logo, Google Play, the Google Play logo, and Android™ are trademarks or registered trademarks of Google Inc.
- All other company and product names that appear in this document are trademarks or registered trademarks of their respective owners.

Safety precautions

Important information

Warning:

To prevent fire or shock hazard, do not expose this apparatus to rain or moisture.

Caution:

Do not expose this apparatus to drips or splashes.

To avoid electric shock, do not open the cabinet.

Refer servicing to qualified personnel only.

Do not expose this apparatus to excessive heat such as that generated by sunshine, fire or other heat sources.

Do not subject this apparatus to strong impact.

This apparatus should be located close enough to the AC outlet so that you can easily grasp the power cord plug at any time.

In case of emergency, disconnect the power cord plug of this apparatus quickly.

Do not place any objects filled with liquids, such as vases, on this apparatus.





To prevent fire, do not place any naked flame sources (such as lighted candles) on this apparatus.

Do not install this apparatus in a confined space such as a bookcase or similar unit.

Install this apparatus only in the places with good ventilation.

This apparatus is not disconnected from the mains as long as it is connected to the AC outlet, even if the unit itself has been turned off.

For customers in the USA/Canada

	CAUTION RISK OF ELECTRIC SHOCK DO NOT OPEN	
Caution: To prevent electric shock, do not remove the cover. There are no user-serviceable parts inside. Internal adjustments are for qualified professionals only. Refer all servicing to qualified service personnel.		
	The lightning flash with arrowhead symbol, within an equilateral triangle, is intended to alert the user to the presence of uninsulated "dangerous voltage" within the product's enclosure that may be of sufficient magnitude to constitute a risk of shock to persons.	
	The exclamation point symbol within an equilateral triangle is intended to alert the user to the presence of important operating and maintenance (servicing) instructions in the literature accompanying the product.	

Important safety instructions

- 1) Read these instructions.
- 2) Keep these instructions.
- 3) Heed all warnings.
- 4) Follow all instructions.
- 5) Do not use this apparatus near water.
- 6) Clean only with dry cloth.
- 7) Do not block any of the ventilation openings. Install in accordance with the manufacturer's instructions.
- 8) Do not install near any heat sources such as radiators, heat registers, stoves, or other apparatus (including amplifiers) that produce heat.
- 9) Do not defeat the safety purpose of the polarized or grounding plug. A polarized plug has two blades with one wider than the other. A grounding plug has two blades and a third grounding prong. The wide blade or the third prong is provided for your safety. If the provided plug does not fit into your outlet, consult an electrician for replacement of the obsolete outlet.
- 10) Protect the power cord from being walked on or pinched particularly at plugs, convenience receptacles, and the point where they exit from the apparatus.
- 11) Only use attachments/accessories specified by the manufacturer.
- 12) Use only with a cart, stand, tripod, bracket, or table specified by the manufacturer, or sold with the apparatus.
- 13) When a cart is used, use caution when moving the cart/apparatus combination to avoid injury from tip-over.
- 14) Unplug this apparatus during lightning storms or when unused for long periods of time.
- 15) Refer all servicing to qualified service personnel. Servicing is required when the apparatus has been damaged in any way, such as power-supply cord or plug is damaged, liquid has been spilled or objects have fallen into the apparatus, the apparatus has been exposed to rain or moisture, does not operate normally, or has been dropped.



Safety precautions

FCC notice

Warning:

This device complies with Part 15 of the FCC Rules. Operation is subject to the following two conditions: (1) This device may not cause harmful interference, and (2) this device must accept any interference received, including interference that may cause undesired operation.

Caution:

You are cautioned that any changes or modifications not expressly approved in this manual could void your authority to operate this equipment.

Note:

This equipment has been tested and found to comply with the limits for a Class B digital device, pursuant to part 15 of the FCC Rules. These limits are designed to provide reasonable protection against harmful interference in a residential installation. This equipment generates, uses and can radiate radio frequency energy and, if not installed and used in accordance with the instructions, may cause harmful interference to radio communications. However, there is no guarantee that interference will not occur in a particular installation. If this equipment does cause harmful interference to radio or television reception, which can be determined by turning the equipment off and on, the user is encouraged to try to correct the interference by one or more of the following measures:

- Reorient or relocate the receiving antenna.
- Increase the separation between the equipment and receiver.
- Connect the equipment into an outlet on a circuit different from that to which the receiver is connected.
- Consult the dealer or an experienced radio/TV technician for help.

For customers in Canada

IC statement

CAN ICES-3 (B)/NMB-3 (B)

Notes on use

About the product

- When using the product, also read the user manuals supplied with the devices that are to be connected.
- When not using the product, remove the power plug from the power outlet.
- Turn the product off before connecting or disconnecting cables.
- If you use the product near a TV or radio antenna, noise may be generated in the TV or radio. In this case, move the product away from the TV or radio antenna.

Maintenance

- If the product becomes dirty or dusty, disconnect the power plug first, and then wipe the product off with a dry soft cloth.
- Do not use benzine, thinner, contact restoring protective agent, or any other chemical agent. Doing so may cause deformation, damage, or malfunction.
- When storing the product for an extended period of time, wrap it with a plastic cover, and do not allow it to be exposed to humidity.

Features

Features of ATDM-0604

- 4 Mic inputs, 2 Mic/Line inputs, 1 unbalanced stereo input
- 2 balanced outputs, 1 unbalanced stereo output
- USB audio I/O (1 stereo input and 1 stereo output)
- Built-in SmartMixer that allows for a selection between gain sharing and gate modes
- Equipped with an echo canceler and a noise canceler that can be used simultaneously (with up to 6 Mic inputs)
- Includes a 4-band EQ for each input channel, and a 12-band EQ for each output channel
- Equipped with a compressor, a limiter, and a 8-band feedback suppressor for each output channel
- Audio input/output settings can be configured on the front panel, whereas the advanced settings can be configured on a computer using Web Remote.
- Allows for external control with IP Remote Protocol
- Supports ES954 Hanging Microphone Array and can be set from a Windows-based PC, Mac, iOS or Android device through the Web Remote
- Equipped with a ducking function

About Audio-Technica LINK

Up to six ATDM-0604 model mixers can be daisy-chained so that, as a whole system, it can handle audio inputs from 24 Mic channels, 12 Mic/Line channels, and 6 unbalanced stereo channels.

The proprietary Audio-Technica LINK functionality enables the transmission of low-latency, high-speed audio bus signals between devices, making it possible to steadily control and transmit uncompressed audio signals. Furthermore, the model offers excellent workability as it conforms to the Ethernet standards and can be connected to generic LAN cables (shielded cables of Cat5e or above with the conductor diameter size of 24 AWG or larger are recommended).

System installation

Installing on a rack

The product can be installed using the supplied rack-mount.

- When installing the product on a rack, make sure that the temperature inside the rack does not reach or exceed 40°C. Higher temperatures may negatively affect the internal parts of the product, causing the product to malfunction.
- Ensure at least a 10-centimeter space between the product and other devices or the top, side, and back faces of the rack.
- The required rack specifications are as follows.
 - EIA-standard 19-inch rack
 - 1U-size attachable rack
 - Rack with a shelf on which the product is placed or a guide rail that supports the product
- The rack mounts are affixed to the product with the following screws. Check the following when using screws other than those supplied.
 - S-tight (tapping screw), nominal diameter 4 × 6 mm

System installation

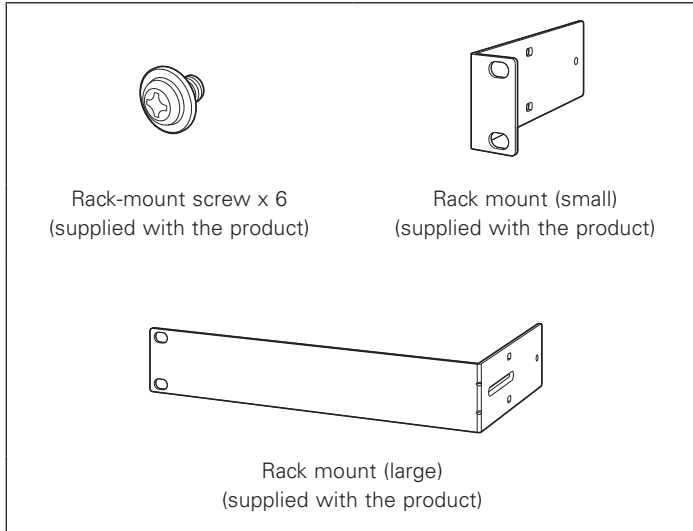

1. Attach the rack mounts to the product.

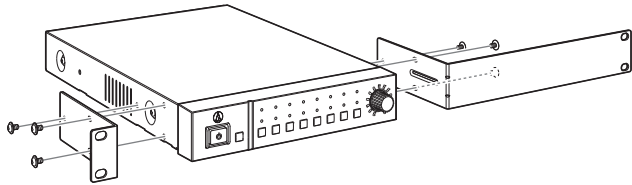

2. Install the product on the rack.

- To install the product on the rack, use the screws supplied with the rack or commercially available screws.

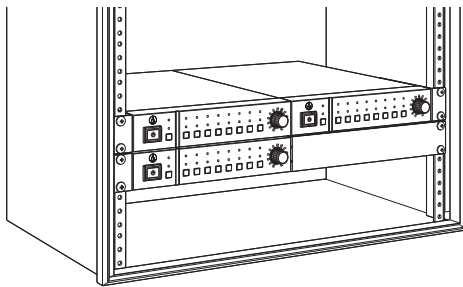

System installation

Unbalanced connection

An unbalanced connection tends to be subject to induction noise caused by the chassis potential differences. Be sure to match the chassis potentials between devices.

- Match the power supply phases between devices.
- Standardize the power supply systems.
- Connect the GND (ground) terminal or chassis of each device.

Power cable connection

- Connect the power plug to the appropriate outlet with protective grounding. Electric shock may result if the plug is not grounded securely.

How to connect a Euroblock connector

1. As shown in the figure, expose the wires inside the cable.

- Do not solder the stranded wires.

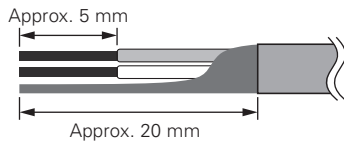

2. Loosen the screws with a flathead screwdriver.

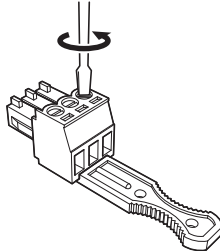

3. Verify the pin assignments, and connect each to the applicable wire.

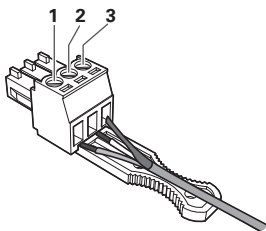

- Pin assignments

		1	2	3
INPUT	1 to 6	+: HOT	-: COLD	G: GND
	ST	R: RIGHT	L: LEFT	G: GND
OUTPUT	1/L, 2/R	+: HOT	-: COLD	G: GND
	UNBAL	R: RIGHT	L: LEFT	G: GND

4. Tighten the screws and bundle the wires with a cable tie.

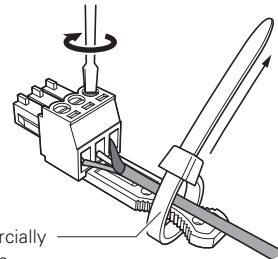

Use any commercially available cable tie.

5. Connect the Euroblock connector to the product.

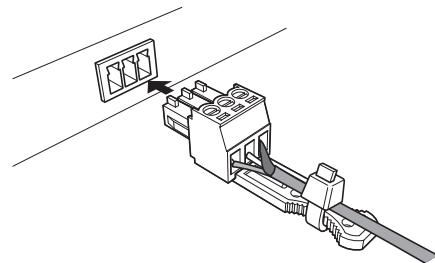

System connection examples

Local discussion (Preset #2)

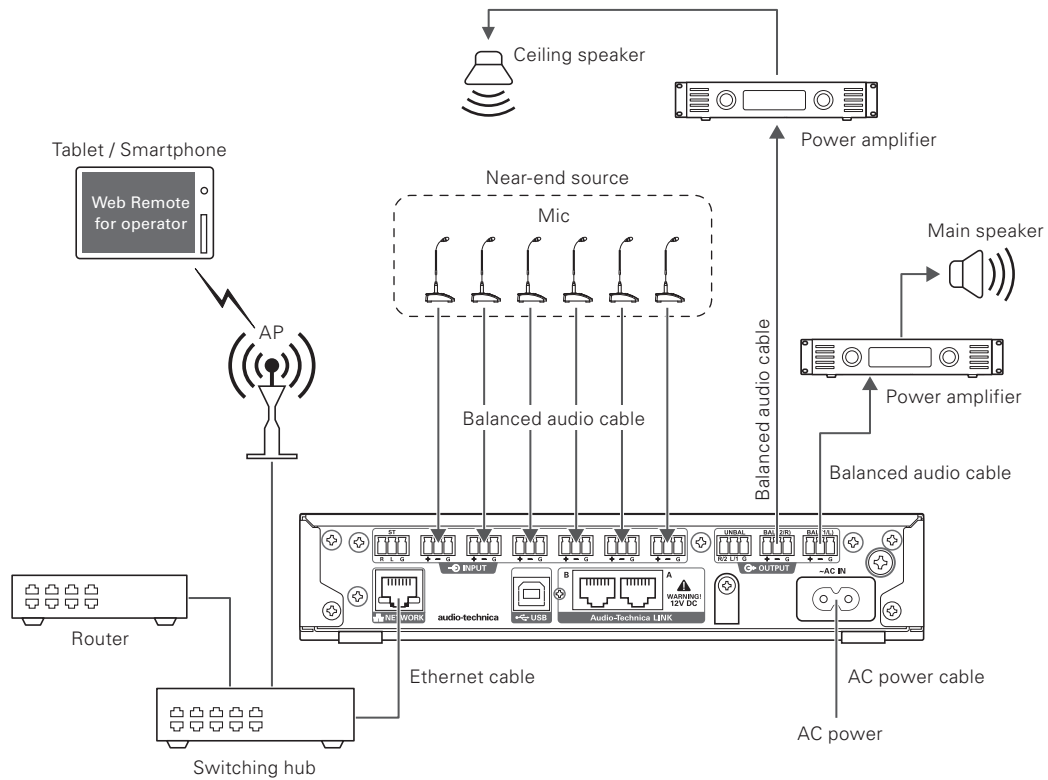

Remote discussion - web conference (Preset #3)

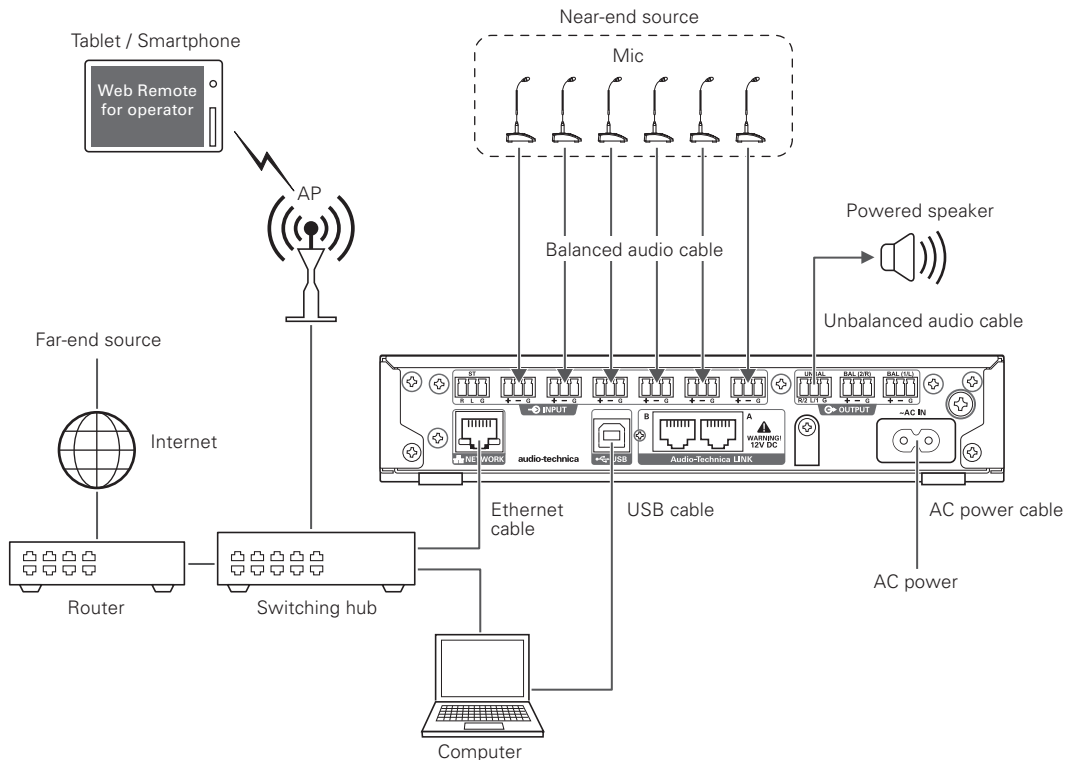

System connection examples

Remote discussion - video conference (Preset #4)

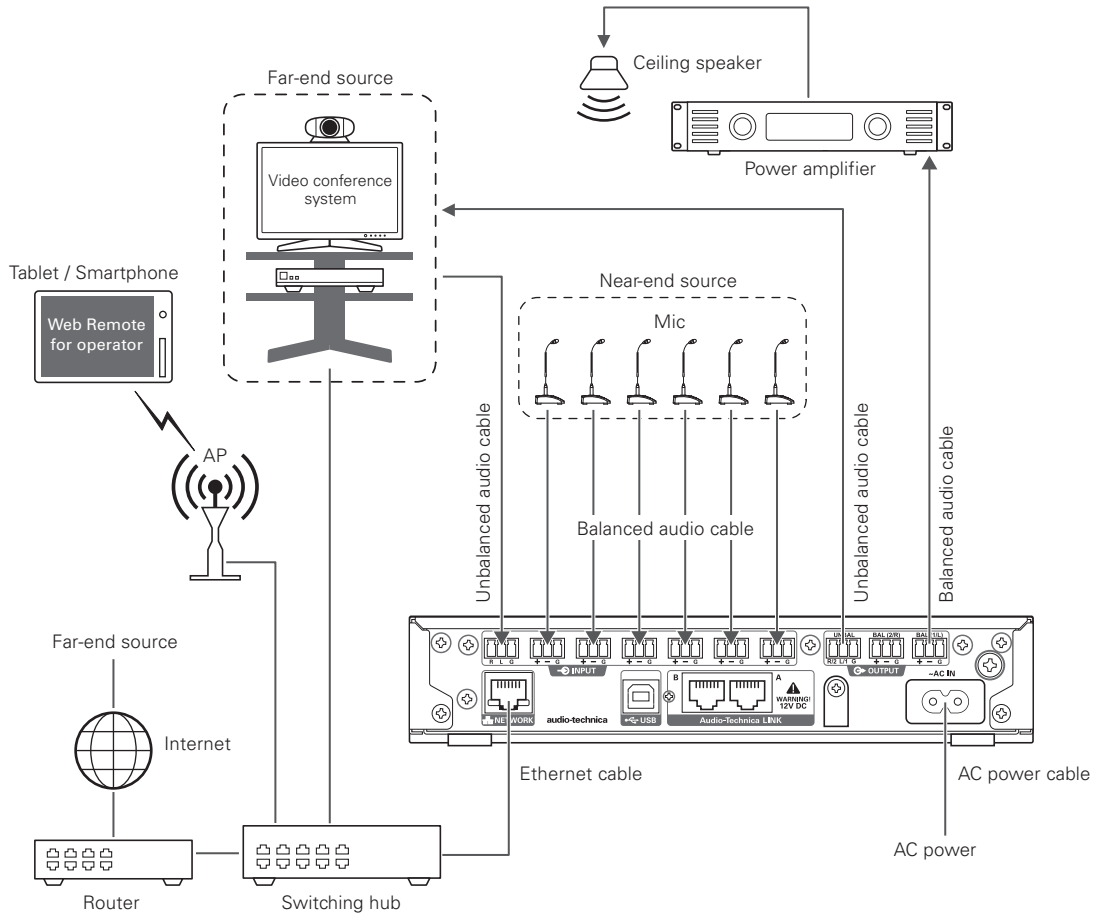

Part names and function

Front panel

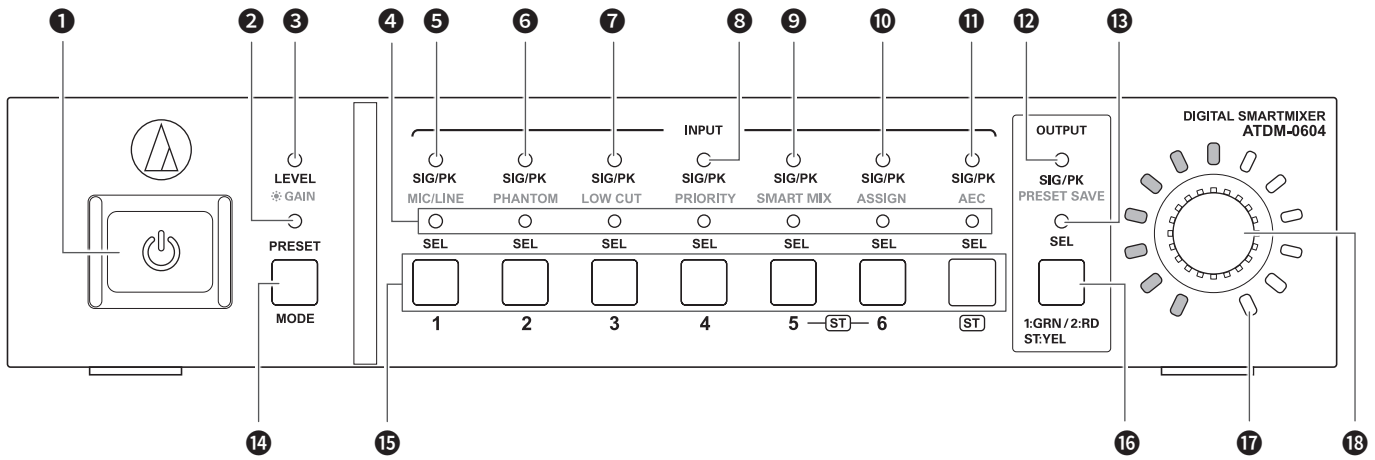

- 1** Power button ()
Turns on/off the power to the product.
- 2** PRESET LED
Lights and blinks when the power is turned on and indicates that the product is being started.
Lights when a preset is being recalled.
- 3** LEVEL-GAIN LED
Lit: You can adjust the input level and output level.
Blinking: You can adjust the gain.
- 4** INPUT SEL LED
Indicates the input channel, preset bank number, and the status of the function/setting of each channel.
- 5** SIG/PK-MIC/LINE LED
Indicates the signal level of input channel 1 when the level or gain is being adjusted.
Also lights when the input type is changed (MIC/LINE).
- 6** SIG/PK-PHANTOM LED
Indicates the signal level of input channel 2 when the level or gain is being adjusted.
Also lights when on/off of the phantom power is set.
- 7** SIG/PK-LOW CUT LED
Indicates the signal level of input channel 3 when the level or gain is being adjusted.
Also lights when on/off of the low-cut is set.
- 8** SIG/PK-PRIORITY LED
Indicates the signal level of input channel 4 when the level or gain is being adjusted.
Also lights when on/off of the priority is set.
- 9** SIG/PK-SMART MIX LED
Indicates the signal level of input channel 5 when the level or gain is being adjusted.
Also lights when on/off of the SmartMixer is set.
- 10** SIG/PK-ASSIGN LED
Indicates the signal level of input channel 6 when the level or gain is being adjusted.
Also lights when on/off of the output bus assignment is set.
- 11** SIG/PK-AEC LED
Indicates the signal level of input channel ST when the level or gain is being adjusted.
Also lights when on/off of the AEC is set.
- 12** SIG/PK-PRESET SAVE LED
Indicates the signal level of an output channel when the level or gain is being adjusted.
Also lights when a preset is saved.
- 13** OUTPUT SEL LED
Indicates if an output channel is selected.
- 14** MODE button
Selects a function.
- 15** INPUT SEL button
Selects an input channel or preset number.
- 16** OUTPUT SEL button
Selects the output channel. Lights green for Output 1, red for Output 2, or yellow for Output ST.
- 17** Volume LED
Indicates the current setting of the selected channel when the level or gain is being adjusted.
- 18** Dial button
Turn the dial button to select, and push to confirm the selection.

Part names and function

- An LED can be in one of five statuses.

- (1) Lit: Indicates that a function is selected and enabled, etc.
- (2) Off: Indicates that a function is not selected and disabled, etc.
- (3) Blinking: Indicates that a function is being selected. Repeats every 500 ms until the status changes.
- (4) Blinking fast: Indicates that the operation has been rejected. Repeats blinking five times every 200 ms.
- (5) Dimmer lit: Indicates lower brightness.

- The signal level ranges indicated by the SIG/PK LEDs are as follows.

- LED lit (red): 0 dBFS to -5 dBFS
- LED lit (yellow): -6 dBFS to -24 dBFS
- LED lit (green): -25 dBFS to -59 dBFS
- LED off: -60 dBFS or less

Rear panel

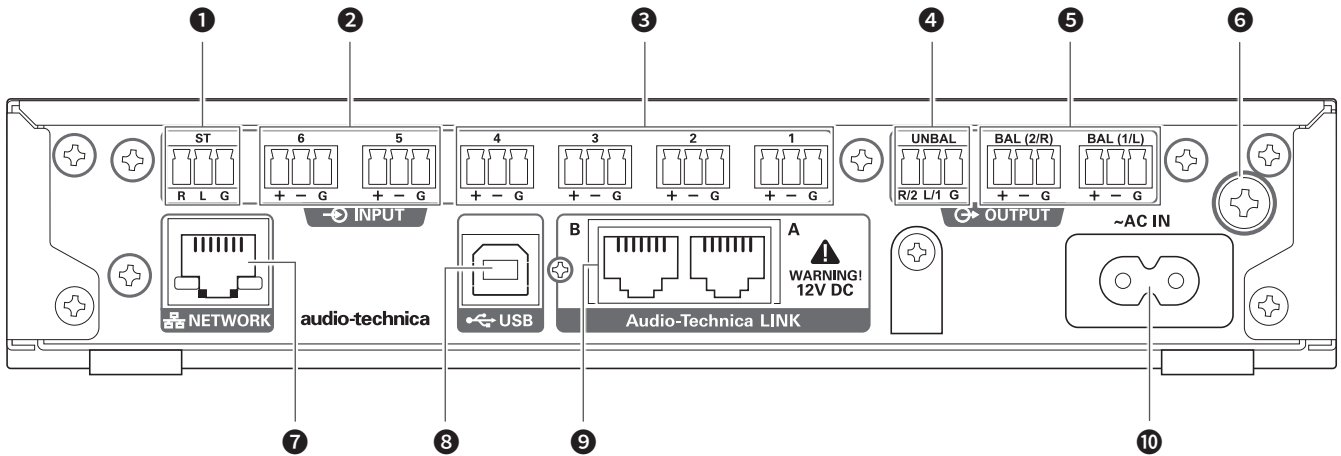

1 Unbalanced input port (ST)

An unbalanced input port. Connect an unbalanced cable.
Pin assignments are as follows. 1: STEREO R 2: STEREO L and 3: GND.

2 Balanced input port (MIC/LINE)

A balanced input port. Connect a balanced cable. The input type setting (MIC/LINE) can be changed.
Pin assignments are as follows. 1: HOT, 2: COLD, and 3: GND.

3 Balanced input port (MIC)

A balanced input port. Connect a balanced cable.
Pin assignments are as follows. 1: HOT, 2: COLD, and 3: GND.

4 Unbalanced output port (UNBAL)

An unbalanced output port. Connect an unbalanced cable.
Pin assignments are as follows. 1: STEREO R/2 2: STEREO L/1 and 3: GND.

5 Balanced output port (BAL 1/L-2/R)

A balanced output port. Connect a balanced cable.
Pin assignments are as follows. 1: HOT, 2: COLD, and 3: GND.

6 Grounding screw

The supplied power cable is a 2-core cable, and cannot be used for grounding. Ground the product as necessary.

7 NETWORK port

A NETWORK port. Connect an Ethernet cable (Cat5e or above).

8 USB port

A USB port (USB Type B). Connect a USB cable.

9 LINK A/B port

A LINK A/B port. Used for Audio-Technica LINK.
Connect an Ethernet cable (Cat5e or above with 24 AWG or larger ; shielded cable recommended). PoE will be available in a future software update.
The maximum current supplied is 0.24A per port.

10 AC inlet

Connect the power cable.

Using the product

Starting the product

1. Press the power button.

- The PRESET LED lights, blinks, and LEVEL-GAIN LED turns on. Then, the PRESET LED turns off, and the product starts in operator mode.

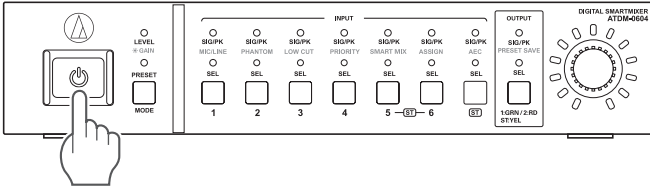

Front panel mode

The following two modes are available for operating the product by using the buttons and the dial on the front panel.

Operator mode:

In this mode, daily operations are performed, such as loading the preset settings and adjusting the audio level.

Advanced mode:

In this mode, advanced settings can be configured by installing and implementing the product on site.

- When the power is turned on, the product usually starts in operator mode. This prevents accidental device setting changes or other troubles, and ensures safe operation of the system.

Changing the front panel mode (operator mode/advanced mode)

Change between operator mode and advanced mode.

1. While pressing the MODE button, press and hold the dial button (for 1 or more seconds).

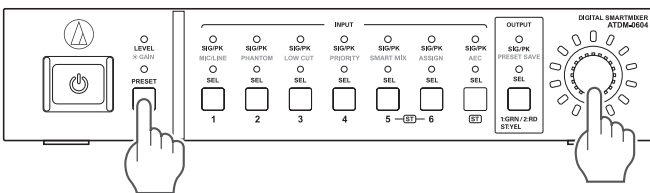

2. LEDs light/blink/turn off, and the front panel mode changes.

- When changing to operator mode
 - The LEVEL-GAIN LED and the PRESET LED light.
 - The PRESET LED turns off.
 - The front panel mode changes to operator mode.
- When changing to advanced mode
 - The LEVEL-GAIN LED, the PRESET LED, and the LEDs from SIG/PK-MIC/LINE to SIG/PK-PRESET SAVE become lit.
 - All LEDs turn off except the LEVEL-GAIN LED, which blinks.
 - The front panel mode changes to advanced mode.

Selecting a function

Press the MODE button, or turn the dial button while pressing the MODE button, to select the function.

- Determine the function selected based on the LED that lights (LEVEL-GAIN LED and PRESET LED, or an LED from SIG/PK-MIC/LINE to SIG/PK-PRESET SAVE).

Functions available in operator mode



Functions available in advanced mode

Press the MODE button to change the function in the clockwise direction as shown in the figure. While pressing the MODE button, turn the dial button to change the function to the one in the direction of the dial.

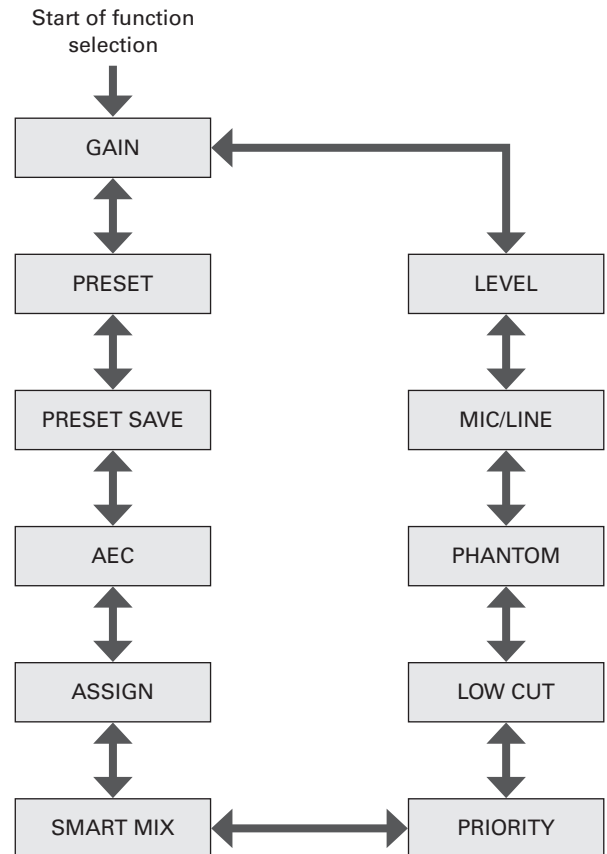

Using the product

Operations that can be performed in operator mode/advanced mode

Recalling a preset

Recall saved preset data to change the current setting.

1. Select "PRESET".
 - The PRESET LED lights.
2. Push the INPUT SEL button to select the preset data to recall (from 1 to 6).
 - The INPUT SEL LED and the volume LED light.
3. Press the dial button.
 - The preset data is read and the settings change.

Adjusting the input level

Set the input level to MIC or LINE. If "LINE" input type is selected, PAD (a function to attenuate the input signal by a certain level) is entered.

1. Select "LEVEL".
 - The LEVEL-GAIN LED lights.
 - The SIG/PK LED of each input channel becomes lit based on the input level.
2. Press the INPUT SEL button to select the input channel you want to adjust.
 - The INPUT SEL LED lights, and the volume LED lights according to the setting.
 - The volume LED that indicates the 0 dB (-20 dBFS) point blinks.
3. Turn the dial button to adjust the input level.
 - The volume LED becomes lit/turns off based on the adjusting operation.
 - When the level is at the 0 dB (-20 dBFS) point, the blinking volume LED becomes lit.

Adjusting the output level

Set the output level.

1. Select "LEVEL".
 - The LEVEL-GAIN LED lights.
 - The SIG/PK LED of the output channel becomes lit based on the output level.
2. Push the OUTPUT SEL button to select the output channel you want to adjust.
 - The color of the OUTPUT SEL LED changes, and it lights according to the selected output channel (OUTPUT 1: Green, OUTPUT 2: Red, OUTPUT ST: Yellow). The volume LED lights according to the setting.
 - The volume LED that indicates the 0 dB (-20 dBFS) point blinks.
3. Turn the dial button to adjust the output level.
 - The volume LED becomes lit/turns off based on the adjusting operation.
 - When the level is at the 0 dB (-20 dBFS) point, the blinking volume LED becomes lit.

Operations available only in advanced mode

Change to advanced mode to perform these operations.

Changing the input type (MIC/LINE)

Specify the input type. Only input channel 5 and input channel 6 can be set.

1. Select "MIC/LINE".
 - The SIG/PK-MIC/LINE LED lights.
2. Press the INPUT SEL button to change the input type between MIC and LINE (+4dBu).
 - The INPUT SEL LED lights when LINE is selected, and it turns off when MIC is selected.

Adjusting the gain

Set the input gain for MIC input.

1. Select "GAIN".
 - The LEVEL-GAIN LED blinks.
 - The SIG/PK LED of each input channel becomes lit based on the input level.
2. Press the INPUT SEL button to select the input channel you want to adjust.
 - The INPUT SEL LED lights, and the volume LED lights according to the setting.
 - The volume LED that indicates the -40 dB point blinks (only when "MIC" is selected as the input type).
3. Turn the dial button to adjust the gain.
 - The volume LED becomes lit/turns off based on the adjusting operation.
 - When the level is at the -40 dB point, the blinking volume LED becomes lit.

• During gain adjustment, press the dial button to switch the volume LED display between gain setting value and level meter. Change the display as necessary. Also, the unity level of each audio output can be switched using the OUTPUT SEL button and dial button.

Turning the phantom power ON/OFF

Turn on/off the phantom power (+48V). This setting can be made only when the input type is set to "MIC".

1. Select "PHANTOM".
 - The SIG/PK-PHANTOM LED lights.
2. Press the INPUT SEL button to switch the phantom power between ON and OFF.
 - The INPUT SEL LED lights when the phantom power is turned on, and it turns off when the phantom power is turned off.

Saving a preset

Save the current settings as a preset.

1. Select "PRESET SAVE".
 - The SIG/PK-PRESET SAVE LED lights.
 - If a preset is currently recalled, the INPUT SEL LED of that preset number becomes lit.
2. Press the INPUT SEL button to select the saving location (from PRESET 1 to PRESET 6).
 - The INPUT SEL LED and the volume LED blink.
3. Press the dial button.
 - The preset is saved to the specified saving location.

Using the product

Turning the low-cut ON/OFF

Specify whether or not to remove low frequencies from the audio signal.

1. Select "LOW CUT."
 - The SIG/PK-LOW CUT LED lights.
2. Press the INPUT SEL button to switch the low-cut between ON and OFF.
 - The INPUT SEL LED lights when the low-cut setting is turned on, and it turns off when the low-cut setting is turned off.

Turning the priority ON/OFF

Set the channel priority. The priority can be set only when SmartMixer is turned on, and gate mode is selected.

3. Select "PRIORITY."
 - The SIG/PK-PRIORITY LED lights.
4. Press the INPUT SEL button to switch the priority between ON and OFF.
 - The INPUT SEL LED lights when the priority is turned on. The INPUT SEL LED turns off when the priority is turned off.

Turning SmartMixer enable/disable

Switch SmartMixer between enable/disable.

Set SmartMixer mode (gate mode or gain sharing mode) via Web Remote (p. 52).

1. Select "SMART MIX."
 - The SIG/PK-SMART MIX LED lights.
2. Press the INPUT SEL button to switch the SmartMixer between enable/disable.
 - INPUT SEL LED lit:
The SmartMixer is turned enable and the audio of that channel is mixed in gate mode or gain sharing mode.
 - INPUT SEL LED off:
The SmartMixer is turned disable.

Setting the bus assignment

Assign and confirm the output bus for an input channel.

1. Select "ASSIGN."
 - The SIG/PK-AEC LED lights.
2. Press the OUTPUT SEL button to select the output bus to be assigned and confirmed.
 - The INPUT SEL LED lights when the channel is assigned to the selected output bus. The INPUT SEL LED turns off when the channel is not assigned.
 - Press the INPUT SEL button to switch the bus assignment.
INPUT SEL LED lit:
Assigned to an output bus. Audio signals not processed by SmartMixer are output even when SmartMixer is turned ON.
INPUT SEL LED blinking:
Assigned to an output bus. Audio signals processed by SmartMixer are output when SmartMixer is turned ON.
INPUT SEL LED off:
Not assigned to any output bus.

Turning the AEC ON/OFF

Turn on/off the AEC (Acoustic Echo Canceled).

1. Select "AEC."
 - The SIG/PK-AEC LED lights.
2. Press the INPUT SEL button to switch the AEC between ON and OFF.
 - The INPUT SEL LED lights when the AEC is turned on, and it turns off when the AEC is turned off.
 - Press the INPUT SEL button for the input channel ST to switch the AEC mode.
INPUT SEL LED of the input channel ST lit: AEC with NC
INPUT SEL LED of the input channel ST blinking: Noise Canceling
INPUT SEL LED of the input channel ST off: OFF

Changing the IP config mode (Auto/Static)

Specify how to obtain the IP address.

1. Press the power button.
 - The PRESET LED becomes lit.
2. When the PRESET LED starts blinking, press down the MODE button, the INPUT SEL button for INPUT channel 4 and the OUTPUT SEL button.
3. When the LEVEL LED becomes lit, release the MODE button, the INPUT SEL button for INPUT channel 4, and the OUTPUT SEL button.
4. The volume LED lights according to the IP Config Mode setting.

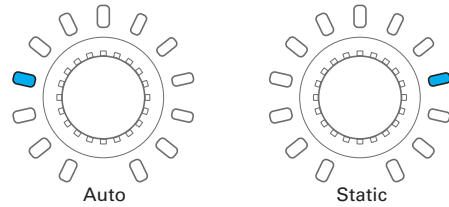

5. Turn the dial button and change the IP Config Mode.
6. Restart the product.

Using the product

Locking the front panel

A lock can be applied so that the front panel operation is disabled.

1. While pressing the OUTPUT SEL button, press and hold the dial button (for 1 or more seconds).

- The front panel becomes locked. Repeat the same steps to disable the lock and enable input/output level adjustment in operator mode or gain adjustment in advanced mode.
- The PRESET LED, the LEVEL/GAIN LED, the INPUT SEL LED, and the volume LED turn off.
- The OUTPUT SEL LED is on while the panel is locked.
- Other LEDs turn on based on the level of an audio input.

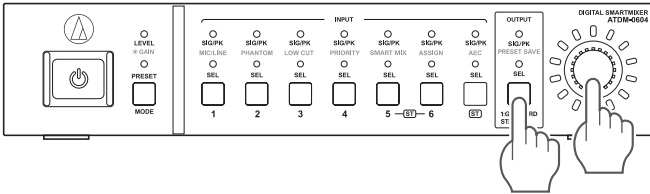

Checking the firmware version

You can view the firmware version of the product.

1. Press the power button.
 - The PRESET LED becomes lit.
2. When the PRESET LED starts blinking, press and hold the MODE button and the dial button.
3. When the LEVEL LED becomes lit, release the buttons.
 - LEDs light according to the firmware version.

(Example) When the firmware version is "02.03.05"

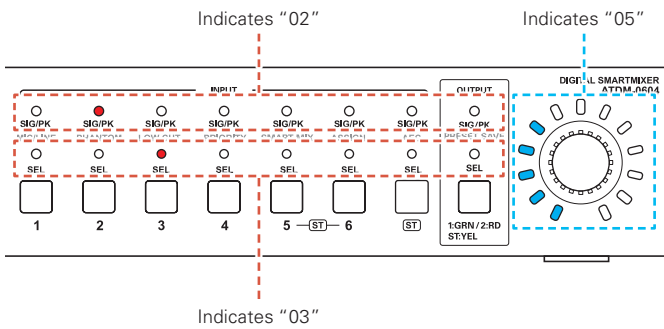

4. Check the firmware version, and turn off the product.

Web Remote

What Is Web Remote?

Web Remote is a web-based application for controlling this product. With Web Remote, you can remotely perform the following tasks from your Windows PC, Mac, iOS or Android device (hereinafter "control device").

- Check the status of the product
- Change the various settings of the product

What is "Locate"?

"Locate" is a launcher application for Web Remote. Connect your control device, then activate "Locate". With "Locate", you can quickly access Web Remote without entering the IP address assigned to the product.

- You can also launch Web Remote without using "Locate".

Recommended environment

OS supporting Web Remote and "Locate"

- Microsoft Windows 7 or later
- Apple OS X 10.11 El Capitan or later
- Android OS 5.0 or later
- iOS 9 or later

Recommended web browsers for Web Remote

- Microsoft Internet Explorer 11 (Windows)
- Google Chrome ver. 57 or later (Windows and Android)
- Mozilla Firefox ver. 52 or later (Windows)
- Safari 10 or later (OS X and iOS)

- You can log into Web Remote from up to 3 control devices at the same time. If two different web browsers are running on one control device, Web Remote recognizes access from two control devices.
- To exit Web Remote, make sure to log out first, and then close the web browser screen. If the screen is closed without logging out, the session may continue, and you may remain logged into Web Remote.
- The minimum size of the web remote screen is 1024 x 768 pixels. For the control device, use a large enough display monitor to display the Web Remote screen in the web browser.

Preparing Web Remote

Connect a control device to the product

1. Before connecting a control device to the product, network settings for both devices must be performed.

- If IP addresses are obtained automatically when connecting
 - (1) Set the product's IP Config Mode to "Auto".
 - The product ships from the factory in "Auto" mode.
 - (2) Set the control device's network settings so that it connects to the network.
- If static IP addresses are used when connecting
 - (1) Set the product's IP Config Mode to "Static".
 - The IP address is set to a static value.
The default value is "192.168.33.102".

2. Use a wired or wireless connection to connect the control device to the product.

3. Turn on the control device and the product.

- If IP addresses are obtained automatically when connecting, it may take some time before the IP address is set.

Setting up "Locate"

1. Download the "Locate" installer/application to the control device.

- For Windows and Mac:
Download from the Audio-Technica website (www.audio-technica.com) for your country or region.
- For iOS and Android:
Download from the App Store or Google Play.
Upon completion of the download, proceed to Step 4.

2. Double-click "setup.exe" you have downloaded.

- The Setup Wizard opens.

3. Follow the on-screen instructions to install "Locate".

- When installation is complete, the "Locate" icon appears on the desktop.

4. After confirming that the ATDM-0604 is powered up and connected to the same network as the control device, double-click the "Locate" icon.

- "Locate" launches. All ATDM-0604s connected to the network are automatically detected.

5. Select the ATDM-0604 you want to control via Web Remote, and click "Open".

- The Web Remote Login screen appears.



- When clicking the "Identify" button, the button will illuminate in red, and the indicators on the front panel of the selected ATDM-0604 will blink. Use this function to identify a specific ATDM-0604 when multiple ATDM-0604s are connected to the system.

Web Remote

Overview of Web Remote

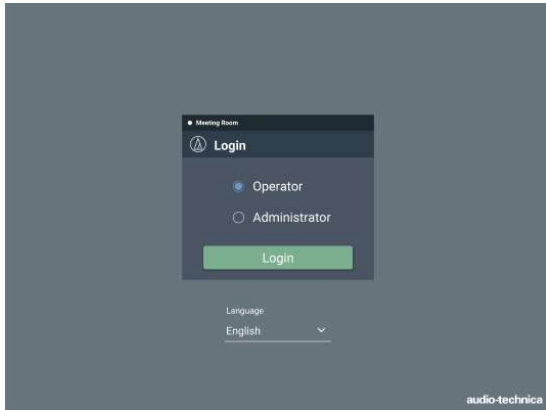

Login screen

Log in as the Operator



Windows/Mac display

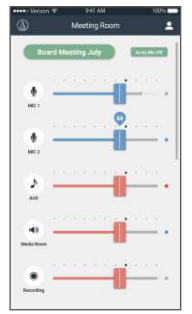

iOS/Android display

Log in as the Administrator



Audio setting

Input:

Set the various options, such as Gain, Level, EQ, and SmartMixer, for audio input from a microphone or other audio devices.

Output:

Set the various options, such as Level, FBS, EQ, and Dynamics, for audio output.

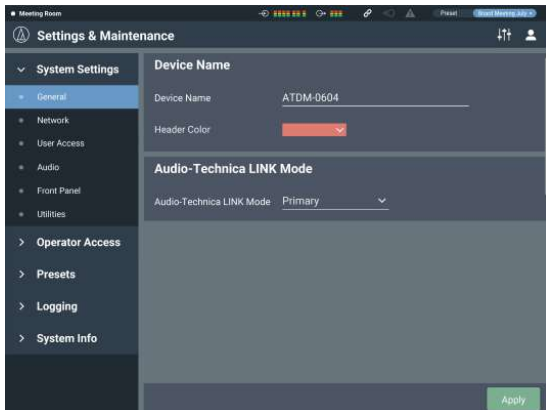

Settings & Maintenance

- System Settings:** Set the options relating to Network, Access Permissions, Audio-Technica LINK, etc., and update the firmware.
- Operator Access:** Set the various options relating to the operation screens you can access after logging in as the Operator.
- Presets:** Recall and save presets and import/export preset data to/from external devices.
- Logging:** Set the options relating to log messages, and download log messages.
- System Info:** System information, such as the various network settings and the product's serial number and firmware version, is displayed.

- To log in as the administrator, you must use a Windows PC or a Mac computer. Operations using a tablet or a smartphone are not guaranteed.

Launch/Log into Web Remote

Launching Web Remote

Launching from "Locate"

1. Launch "Locate" you have installed in the control device.
2. From the list, select the ATDM-0604 for which you want to launch Web Remote.
 - Web Remote launches, and the Login screen appears.

Specifying an IP address to launch the Web Remote

If you know the IP address of the product, you can launch Web Remote by specifying the IP address directly.

1. Open the control device's web browser.
2. Enter the IP address of the ATDM-0604 for which you want to launch Web Remote.
 - Web Remote launches, and the Login screen appears.

Login screen

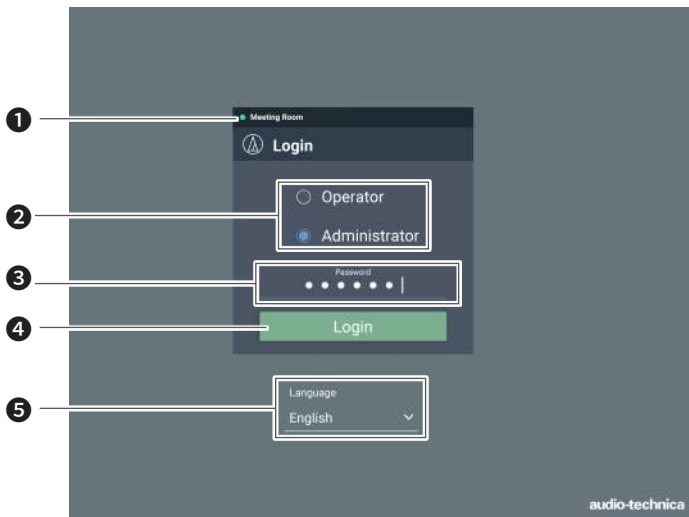

- 1 **Device name**
The name set for the product is displayed.
- 2 **Mode selection**
Select "Operator" or "Administrator" as the login user.
- 3 **Password**
Enter the password.
 - This field appears when login as the Administrator is locked. For the password settings, refer to "Login Password" (p.39).
- 4 **Login button**
- 5 **Language**
Select the display language for Web Remote.

Logging into Web Remote

1. Select "Operator" or "Administrator", and then click "Login".
 - If "Administrator" is selected, the password entry field appears. Enter the password, and then click "Login".

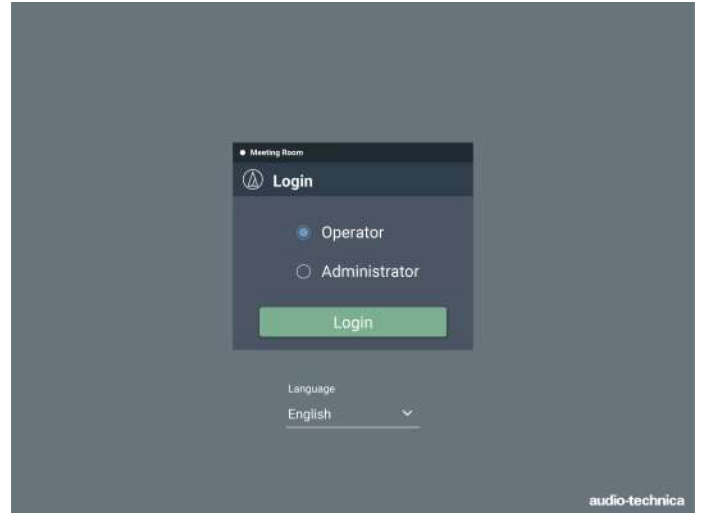

Logging out of Web Remote

1. Click the Logout icon.



2. Click "Log out".
 - Log out of Web Remote.

Operator screen

If you log in as the Operator, you can import the presets, adjust the volumes, and set other options required in day-to-day operations, through simple steps.

Windows/Mac screen



- 1 Preset display**
Click to recall a desired preset.
- 2 Volume dial**
Adjust the volume of each input/output channel.
Blue: Input channel
Red: Output channel
- 3 Input/Output icon**
The type and name of each input/output channel are displayed.
When "Array Mic Switch" in "Operator Page Restrictions" (p. 43) is left on, mute is switched on or off every time it is clicked.

iOS/Android screen

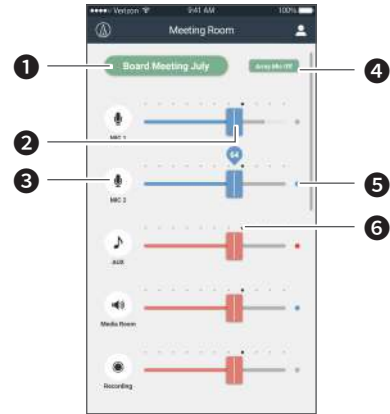

- 4 Array Mic Off**
Click to turn off the array mic.
- 5 Level meter**
The level of each channel is displayed.
 - **Input channel:**
Blue: Input received
Gray: No input
 - **Output channel:**
Blue: Level between -6 to -59 dBFS
Red: Level equal to or greater than -5 dBFS
Gray: No input
- 6 Reference point**
The balance is set as adjusted on the Audio Input Screen at the reference point (70%).

Administrator screen

Header

If you log in as the Administrator, you can access the input/output Settings and Settings & Maintenance screens. The header at the top remains the same on both screens.

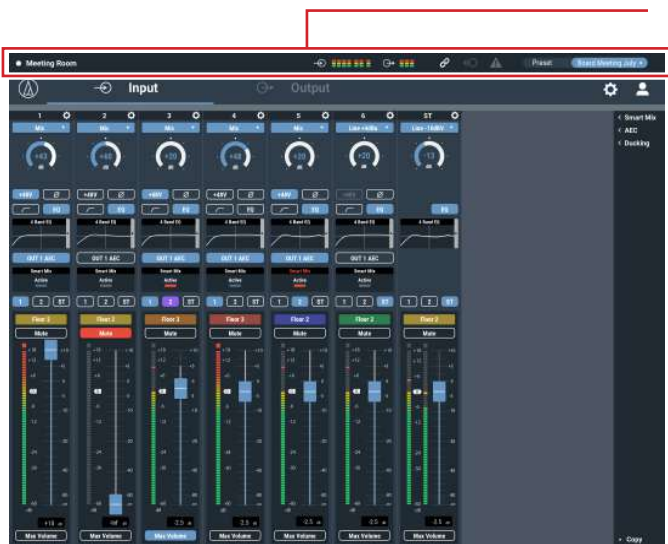

Input Settings

Header

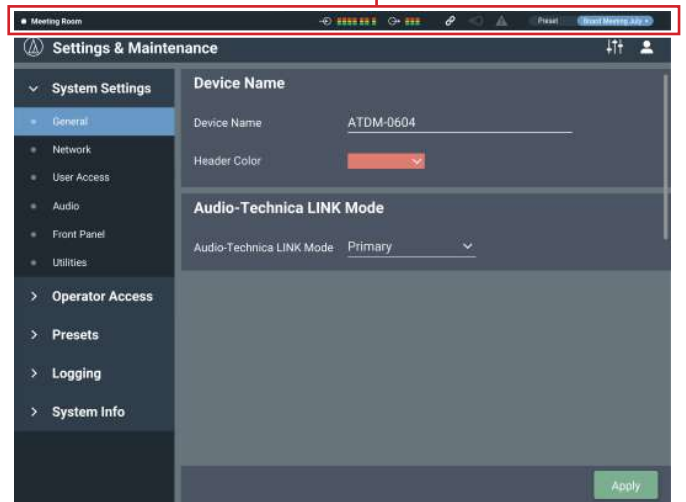

Settings & Maintenance

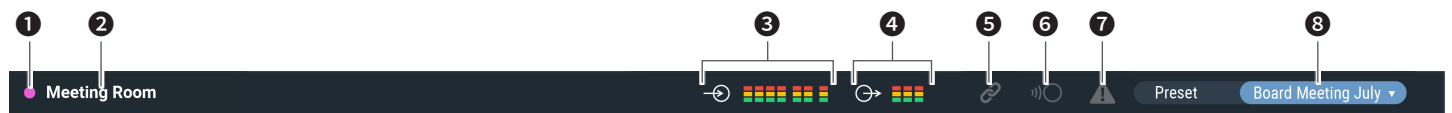











- 1 **Device color**
This color helps you identify each device when multiple products are operated.
- 2 **Device name**
The name set for the product is displayed.
- 3 **Input indicator**
The input level is displayed.
- 4 **Output indicator**
The output level is displayed.

- 5 **Audio-Technica LINK status**
The Audio-Technica LINK connection status is displayed.
- 6 **IP remote status**
The active status of IP control is displayed.
- 7 **Error status**
An error status is displayed.
- 8 **Preset**
The selected preset and the name of the loaded preset are displayed.

Administrator screen

Indicators

Status	Icon display	Description of each status
Audio-Technica LINK status		The Audio-Technica LINK device is not connected correctly.
		The Audio-Technica LINK device is connected correctly.
		There is an Audio-Technica LINK error.
		
IP remote status		Remote control is disabled.
		Remote control is enabled.
		There is a remote control error.
		
Error status		No error is present.
		An error is present.

Error display

When a triangle mark is displayed on an icon, clicking the icon displays a description of the error. After checking the description of the error, move the cursor away from the icon, and the triangle mark will disappear.



Triangle mark

Administrator screen

How to view audio input and output screens



- 1 Click to view the Web Remote version and the Audio-Technica website.
- 2 Click to toggle between the Audio Input and Audio Output Settings screens.
- 3 Click to switch to the Settings & Maintenance screen.

- 4 You can configure the audio input settings for each input channel.
- 5 Click each of these items to display a detailed setting menu.
"Smart Mix": Refer to p. 52.
"AEC": Refer to p. 50.
"USB OUT": Refer to p. 35.
- 6 You can configure the audio output settings for each output channel.

• You may not be able to set and/or operate functions depending on the settings or the conditions. If applicable, those functions are either grayed out or hidden.

Setting the audio input details

Changing the input type (MIC/LINE)

Specify the input type.

1. Click the area in the red box on the screen shown below.

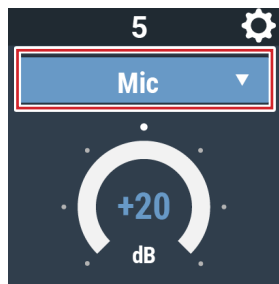

2. Select the input type from the pull-down menu.

- The input type changes.

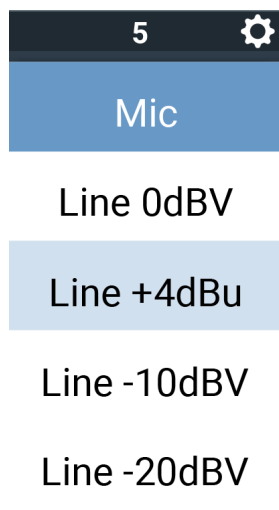

Adjusting the gain

Set the input gain for Mic input.

1. Drag the meter to adjust the gain.

- You can also click the number and enter the gain directly.

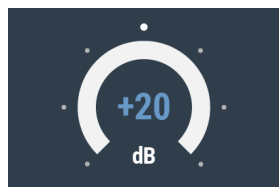

- During input gain adjustment, the level meter turns blue and displays the pre-fader level. Input gain should be adjusted while monitoring the blue level meter.

Turning the phantom power ON/OFF

Turn ON/OFF the phantom power (+48V). This setting can be made only when "Mic" is selected as the input type.

1. Click the area in the red box on the screen shown below.

- The function is turned ON (blue)/OFF (no color) each time the switch is clicked.



Turning the phase ON/OFF

Invert the input audio phase.

1. Click the area in the red box on the screen shown below.

- The function is turned ON (blue)/OFF (no color) each time the switch is clicked.



Turning the low-cut ON/OFF

Specify whether or not to remove low frequencies from the audio signal.

1. Click the area in the red box on the screen shown below.

- The function is turned ON (blue)/OFF (no color) each time the switch is clicked.



Turning the 4-band EQ ON/OFF

Turn ON/OFF the 4-band EQ to be applied to audio inputs.

1. Click the area in the red box on the screen shown below.

- The function is turned ON (blue)/OFF (no color) each time the switch is clicked.



Setting the audio input details

Adjusting the 4-band EQ

Set the 4-band EQ to be applied to audio inputs.

- Click the area in the red box on the screen shown below.
 - The Settings screen appears.



- Set each item.



How to view settings screen (Expert Mode)



- Save an EQ preset, reset the EQ frequency characteristics waveform, or switch the setting screen.
- From the EQ library, recall the EQ preset.
 - If the EQ is adjusted after the data is recalled, the display becomes blank.
- Display and edit the EQ frequency characteristics waveform.
- Change the gain by dragging a meter or directly entering a value.
- Change the frequency by dragging a meter or directly entering a value.
- Change the Q value by dragging a meter or directly entering a value.
- Change the filter type.

Changing settings screen

The Settings screen can be in "Easy Mode" with a simplified display or in "Expert Mode" with all items displayed.

Easy Mode	Select from the pre-arranged EQ patterns to easily adjust the EQ.
Expert Mode	The parameters can be set for each band for finer EQ adjustment.

Click the icon (⚙️) on the top right of the screen to switch between the two.



How to view settings screen (Easy Mode)

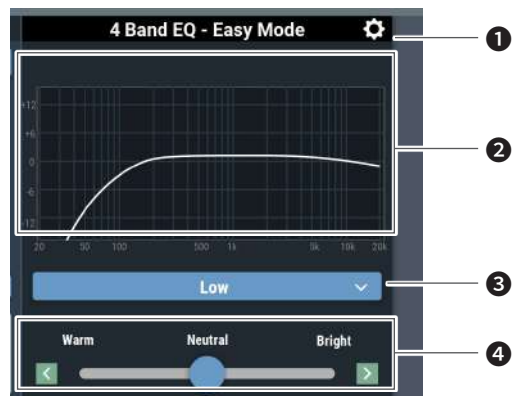

- Save an EQ preset, reset the EQ frequency characteristics waveform, or switch the setting screen.
- Display the EQ frequency characteristics waveform.
- Select the audio type.
- Adjust the tone.

Setting the audio input details

Turning the AEC ON/OFF

Turn ON/OFF the AEC (Acoustic Echo Canceler).

1. Click the area in the red box on the screen shown below.
 - The function is turned ON (blue)/OFF (no color) each time the switch is clicked.



Checking SmartMixer status

2. Check the area in the red box on the screen shown below.
 - Click on the screen to display the SmartMixer Settings screen. For more details, refer to "SmartMixer" (p.52).



	Turned OFF.
	Turned ON.
	Turned ON, and SmartMixer active.

— "Priority" is turned ON if "Smart Mix" is displayed in red.

Turning the bus assignment ON/OFF

Switch the output bus between ON and OFF for each channel.

1. Click the area in the red box on the screen shown below.
 - The function is turned ON (purple)/ON (blue)/OFF (no color) each time the switch is clicked.

ON (Purple)	Audio signals processed by SmartMixer are output when SmartMixer is turned ON.
ON (Blue)	Assigned to an output bus. Audio signals not processed by SmartMixer are output even when SmartMixer is turned ON.
OFF	Not assigned to any output bus.



Setting the audio input details

Setting channel names and colors

Set the name and color of each channel.

1. Click the area in the red box on the screen shown below.



2. Select a color of your choice.

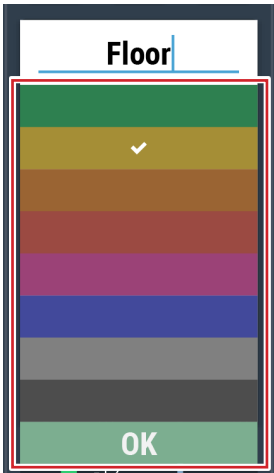

3. Click the text input field and enter the channel name of your choice.

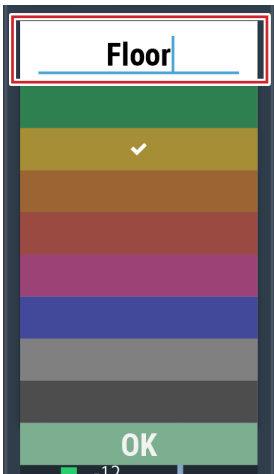

4. Click "OK".

Turning the mute ON/OFF

Switch the mute setting between ON and OFF for each channel.

1. Click the area in the red box on the screen shown below.
 - Mute turns ON (red)/OFF (no color) each time the switch is clicked.



Adjusting the input level

Set the Mic/Line input level for each channel.

2. Drag the volume adjustment dial, and move it up and down to adjust the input level.

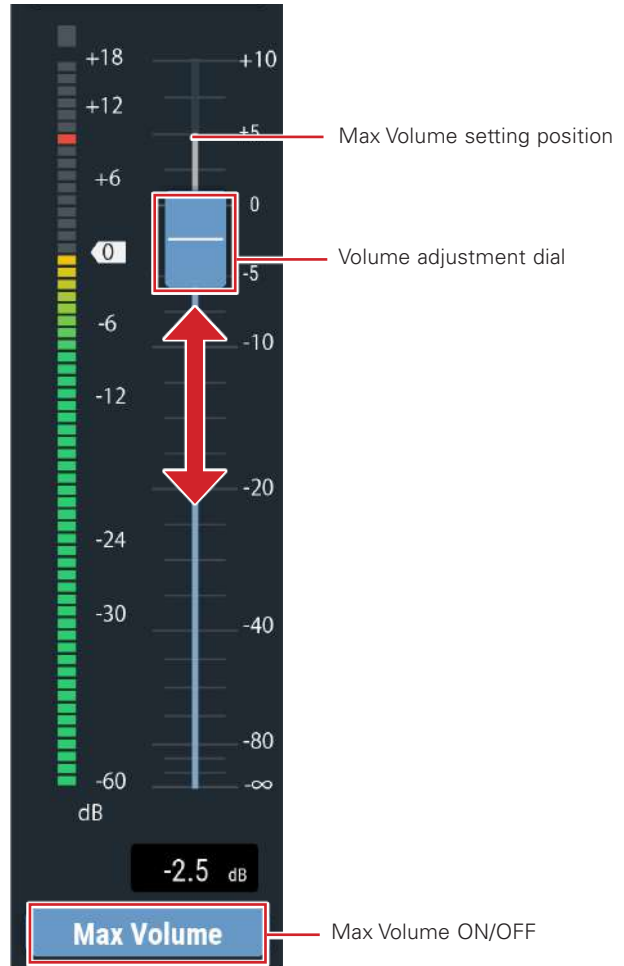

Turning the max volume ON/OFF

Determine the Max Volume and turn it ON/OFF for each channel.

1. Click "Max Volume".
 - The setting is turned ON (blue)/OFF (no color) each time the dial is clicked.
 - The fader maximum is set at the position when the Max Volume is turned ON. The range above the specified position is grayed out. To change the position, turn the Max Volume OFF and then back ON.

Setting the audio output details

Setting the unity level

1. Click the area in the red box on the screen shown below.

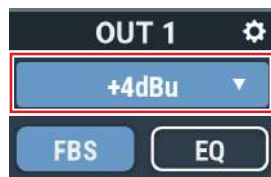

2. Select a unity level from the pull-down menu.

- The unity level changes.

Turning the FBS ON/OFF

Switch the FBS (feedback suppressor) between ON and OFF for each channel.

1. Click the area in the red box on the screen shown below.
 - The function is turned ON (blue)/OFF (no color) each time the switch is clicked.

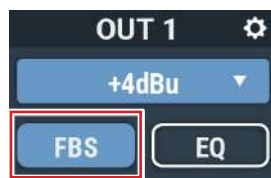

Turning the EQ ON/OFF

Switch the EQ between ON and OFF for each channel.

1. Click the area in the red box on the screen shown below.
 - The function is turned ON (blue)/OFF (no color) each time the switch is clicked.

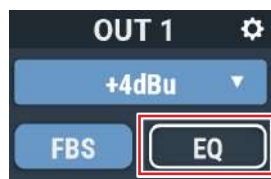

Adjusting the FBS/EQ

1. Click the area in the red box on the screen shown below.
 - The Settings screen appears.



2. Set each item.



Setting the audio output details

How to view settings screen (FBS)

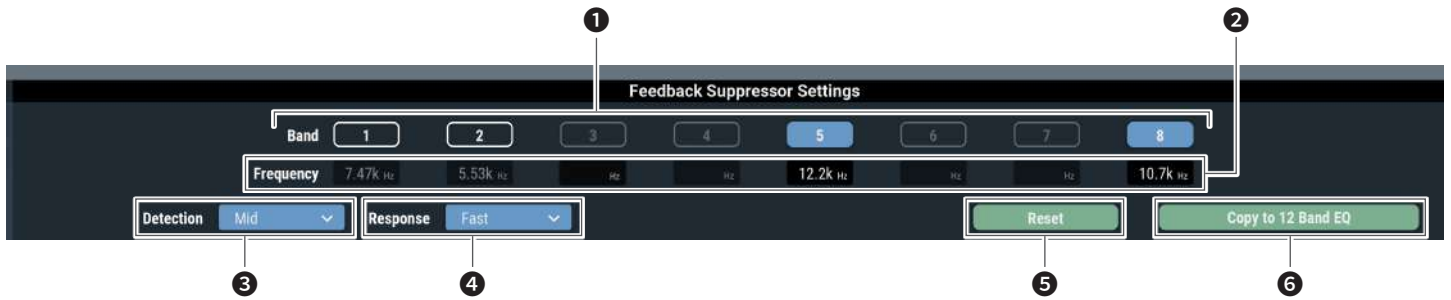

1 The statuses of the bands appear. You can also switch between dynamic and static.

	<p>Dynamic state.</p> <ul style="list-style-type: none"> Indicates that the feedback frequency is detected, and the FBS is functioning. The feedback frequency remains for 15 seconds and is then automatically cleared. Until a new frequency is detected, the feedback frequency display is left blank and turns into a standby state.
	<p>Static state.</p> <ul style="list-style-type: none"> Click this icon in a dynamic state to lock the band and enter a static state. Click the icon again to cancel a static state of the band and enter a standby state.
	<p>Standby state.</p> <ul style="list-style-type: none"> Waiting for a new feedback frequency to be detected.

- 2 The frequencies of the detected feedbacks appear.
- 3 Select the strength to suppress the feedback.
- 4 Select the speed of suppressing the feedback.
- 5 Click to reset the detected frequencies. Once reset, new frequencies are detected (but those of the bands in a static state are not reset).
- 6 Click to copy the static bands to the bands of 12-band EQ. The bands for which the 12-band EQ is turned off are copied.

- Switch the settings of “Detection” (3) or “Response” (4) to reset the band frequencies in a dynamic state.

Setting the audio output details

How to view settings screen (EQ)

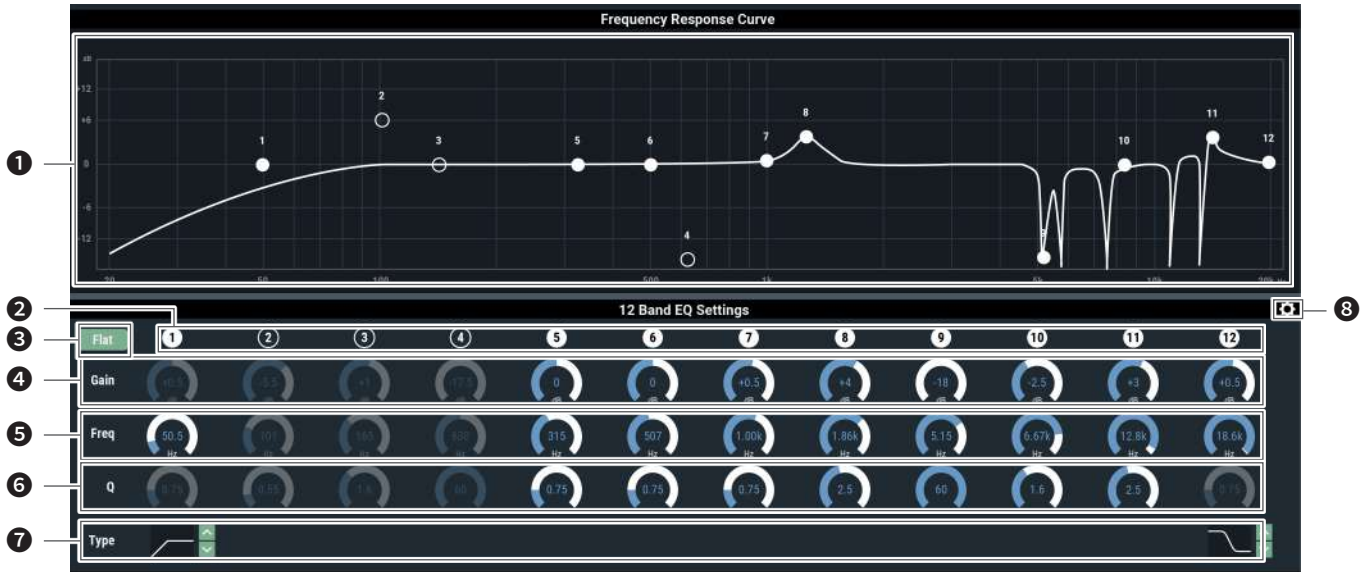

- 1 Display and edit the EQ frequency characteristics waveform. The pointer for each band indicates the frequency and the gain position.
 - Edit the frequency and the gain by dragging a pointer.

- 2 Display and switch the ON/OFF setting of each band. The ON and OFF statuses indicate as follows.

1	Turned ON.
2	Turned OFF.

- 3 In all bands, change the gain to 0 without changing the current frequency.

- 4 Adjust the gain of each band.
- 5 Adjust the frequency of each band.
- 6 Adjust the Q value of each band.
- 7 Change the filter type (applicable to bands 1 and 12 only).
- 8 Reset a parameter and save/recall an EQ preset.

Setting the audio output details

Turning the dynamics function ON/OFF

1. Click the area in the red box on the screen shown below.
 - The function is turned ON (blue)/OFF (no color) each time the switch is clicked.

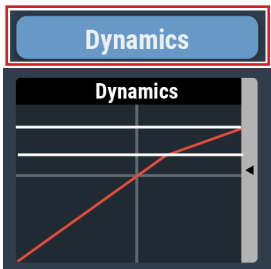

Adjusting the dynamics

1. Click the area in the red box on the screen shown below.
 - The Settings screen appears.

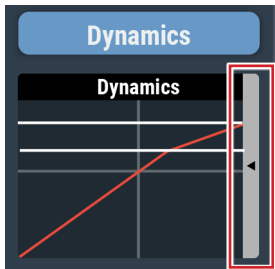

2. Set each item.



Setting the audio output details

How to view settings screen (DYN)

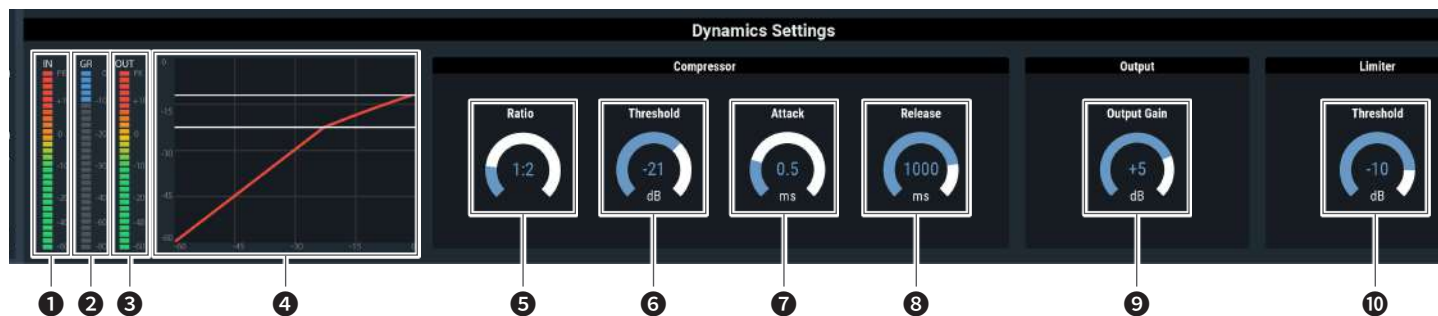

- 1 Indicates the level of audio input to Dynamics.
- 2 Indicates the level of audio gain suppression by the compressor.
- 3 Indicates the level of audio output from Dynamics.
- 4 Indicates the Dynamics characteristic.
- 5 Set the compressor ratio.
- 6 Set the compressor threshold.
- 7 Set the compressor attack time.
- 8 Set the compressor release time.
- 9 Set the Dynamics output gain.
- 10 Set the Limiter threshold.

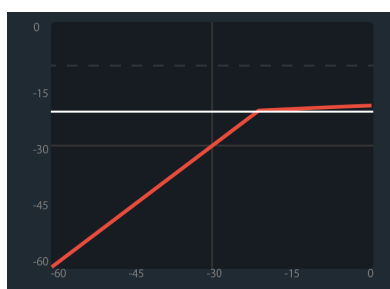
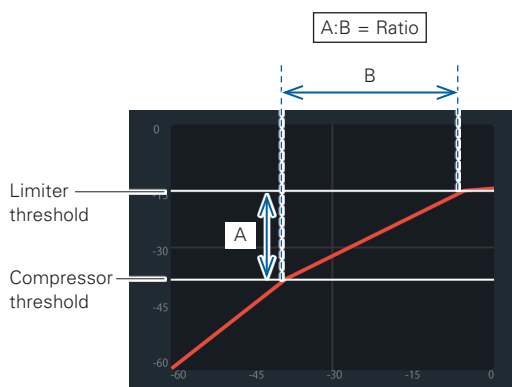

When the limiter threshold is lower than the compressor threshold, the compressor threshold is cleared, and only the limiter threshold is displayed.

Setting the audio output details



Turning the delay function ON/OFF

Specify whether or not to delay the output of each channel.

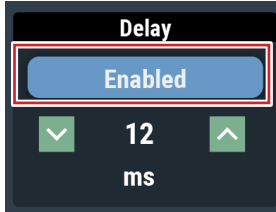
1. Click the area in the red box on the screen shown below.
 - The function is turned ON (blue)/OFF (no color) each time the switch is clicked.



Setting the delay time for delay function

1. Set the amount of time to delay.
 - Click  /  to adjust the time. You can also click the time and enter the value directly.

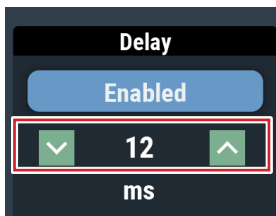

Setting channel names and colors

Set the name and color of each channel.

1. Click the area in the red box on the screen shown below.



2. Select a color of your choice.

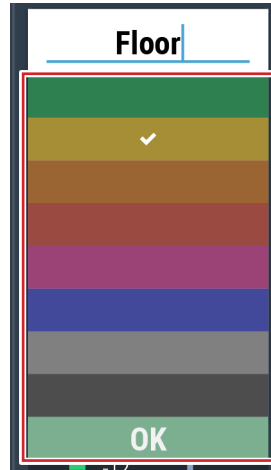

3. Click the text input field and enter the channel name of your choice.

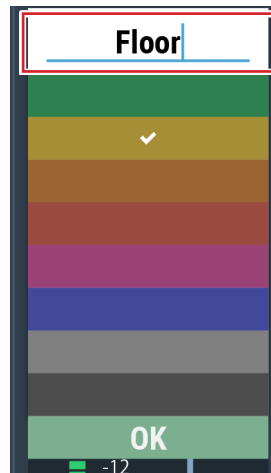

4. Click "OK".

Setting the audio output details

Adjusting the output level

Set the Mic/Line output level for each channel.

1. Click the volume adjustment dial, and move it up and down to adjust the output level.

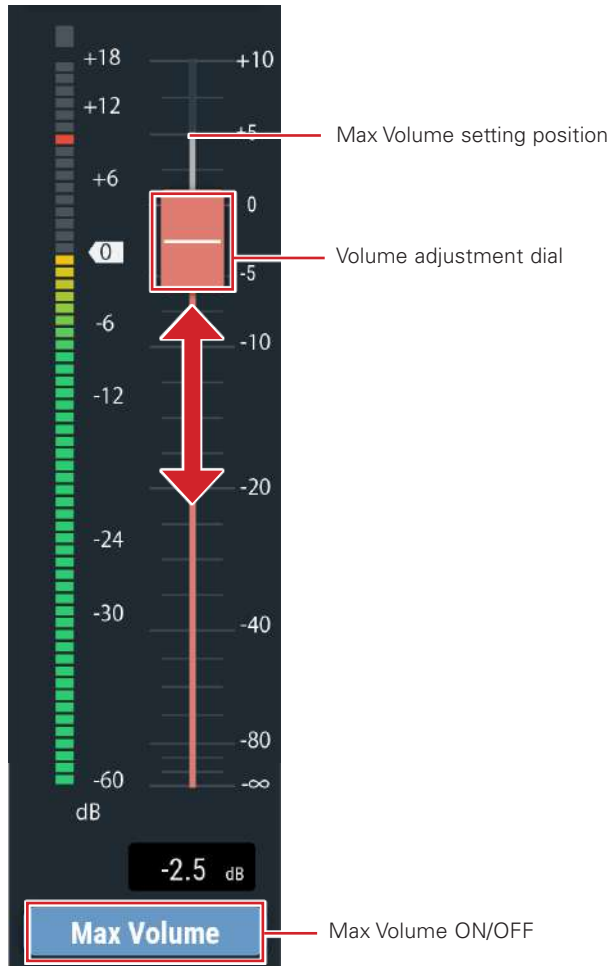

Setting the USB output

Select the USB output bus and set the transmission level.

1. Click "USB OUT".

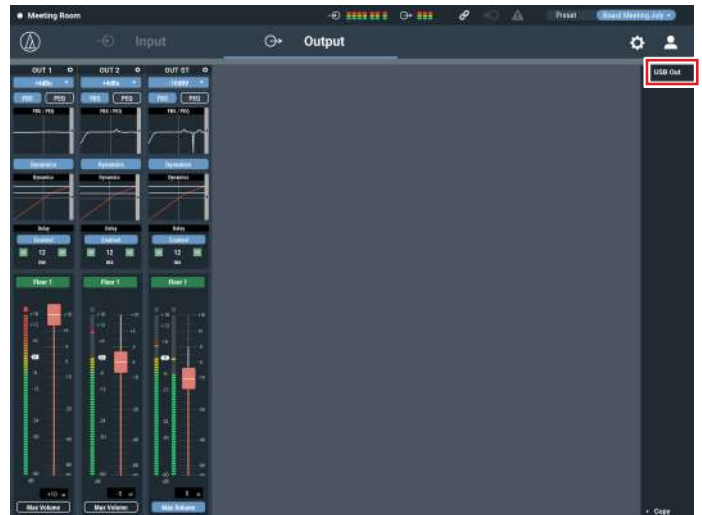

2. Select the bus for USB output.

- You can select up to two sources from "1"; "2"; and "AEC".
- If "ST" is selected, other sources cannot be selected.

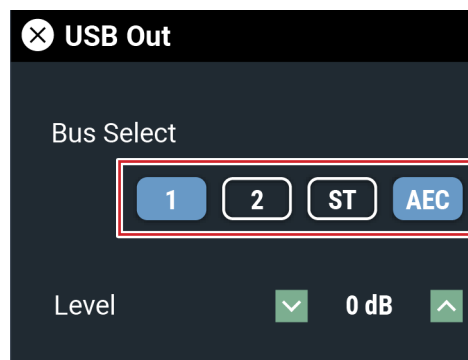

3. Select the level for USB output.

- Click / to adjust the level. You can also click the number and enter another value directly.

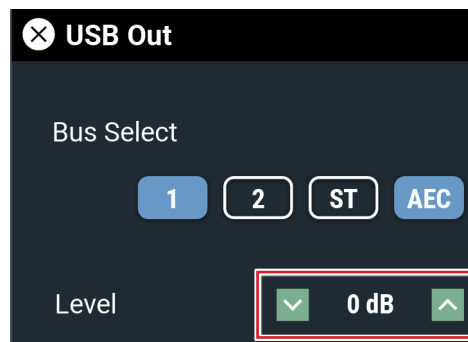

Turning the max volume ON/OFF

Determine the Max Volume and turn it ON/OFF for each channel.

1. Click "Max Volume".

- The function is turned ON (blue)/OFF (no color) each time the dial is clicked.
- The fader maximum is set at the position when the Max Volume is turned ON. The range above the specified position is grayed out. To change the position, turn the Max Volume OFF and then back ON.

Setting the system details (Settings & Maintenance)

Advanced options for the entire system and access utilities to help maintain and troubleshoot the system are available.

Basic operations

1. Click the icon (⚙️) on the top right of the screen.



2. From the list of setting items, select the item you want to set.

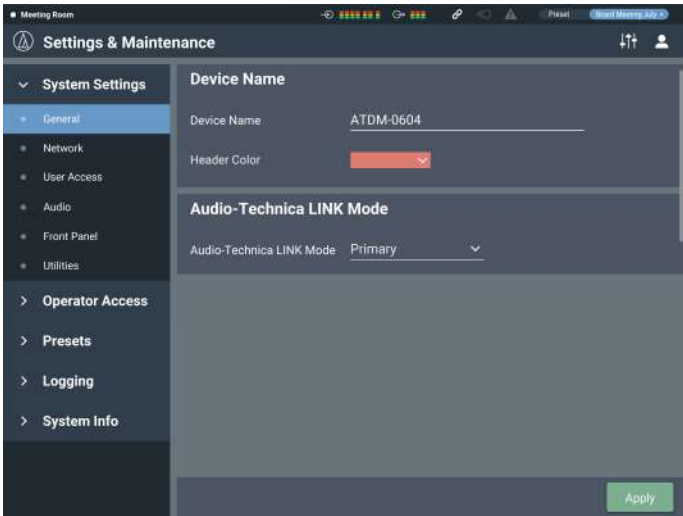

3. Set the item as necessary, and click "Apply".

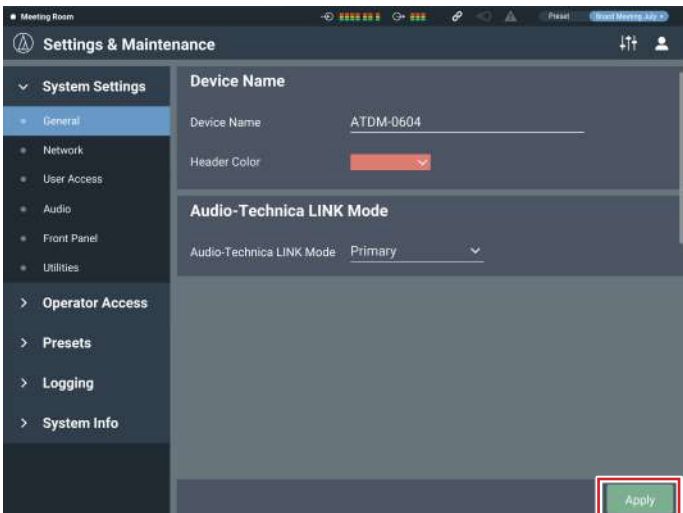

Settings & Maintenance screen

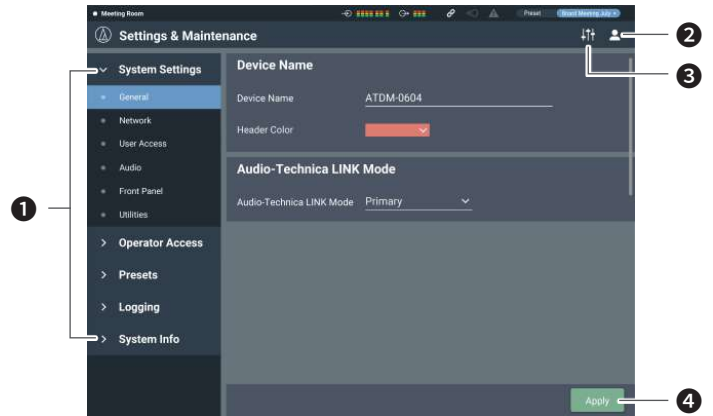

- 1 Setting Items menu
- 2 Log Out icon
- 3 Screen selector icon
The Audio Settings screen appears.
- 4 Apply button
The change made to each setting is reflected.

Setting the system details (Settings & Maintenance)

General in System Settings



Device Name

Device Name	Set the name of the product being controlled from Web Remote.
Header Color	Set the color of the top part (header) of the Web Remote screen.

After setting each item, click "Apply" to complete the setting.

Audio-Technica LINK Mode

Set the operation mode under Audio-Technica LINK (p. 55).

1. Select "Primary" or "Extension".
2. Click "Apply".
 - The setting is now complete.

Setting the system details (Settings & Maintenance)

Network in System Settings

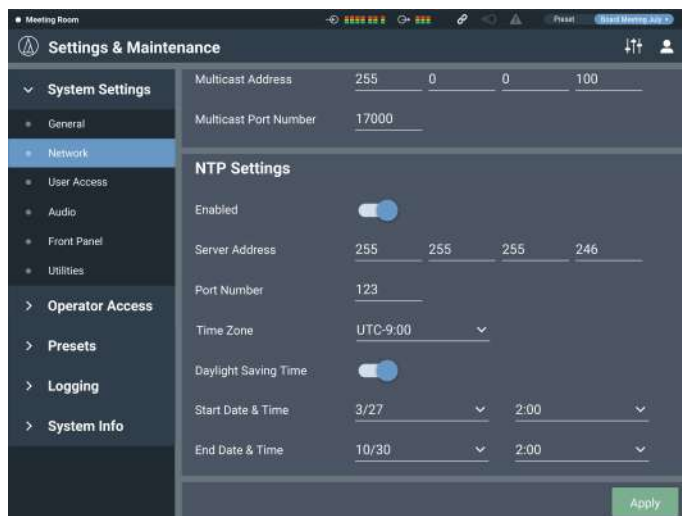

IP Settings

Set how to obtain IP addresses, and specify each value.

- From "IP Config Mode", select "Auto" or "Static":

Auto	IP addresses are automatically assigned from the DHCP server, etc.
Static	Specify static IP addresses. Selecting "Static" enables the "IP Address," "Subnet Mask," and "Gateway Address" fields. Enter the addresses you want to specify. The default value is "192.168.33.102".

- Click "Apply".
 - The setting is now complete.

Allow Discovery

Set the product to be discovered automatically by "Locate".

- Click the switch.
 - The setting is turned ON (blue)/OFF (no color) each time the switch is clicked.
 - When the function is turned on, the product can be identified by "Locate".
- Click "Apply".
 - The setting is now complete.

IP Control Settings

Set the options relating to IP control.

- Set each item.

Port Number	The port number of the IP control is displayed.
Notification	Receive notifications from IP-controlled devices.
Audio Level Notification*	Receive audio level notifications from IP-controlled devices.
Multicast Address*	Set the address for multicast.
Multicast Port Number*	Set the port number for multicast.

* This item can be set only when "Notification" is turned ON (blue).

- Click "Apply".
 - The setting is now complete.

NTP Setting

Set the NTP (Network Time Protocol).

- Set each item.

Enabled	Set whether to enable or disable the NTP (Network Time Protocol).
Server Address	Set the NTP server address.
Port Number	Set the NTP port number.
Time Zone	Set the time difference from the UTC (Coordinated Universal Time).
Daylight Saving Time	Turn on/off the daylight saving time.
Start Date & Time	Set the starting date/time of daylight saving time.
End Date & Time	Set the ending date/time of daylight saving time.

- Click "Apply".
 - The setting is now complete.

Setting the system details (Settings & Maintenance)

User Access in System Settings

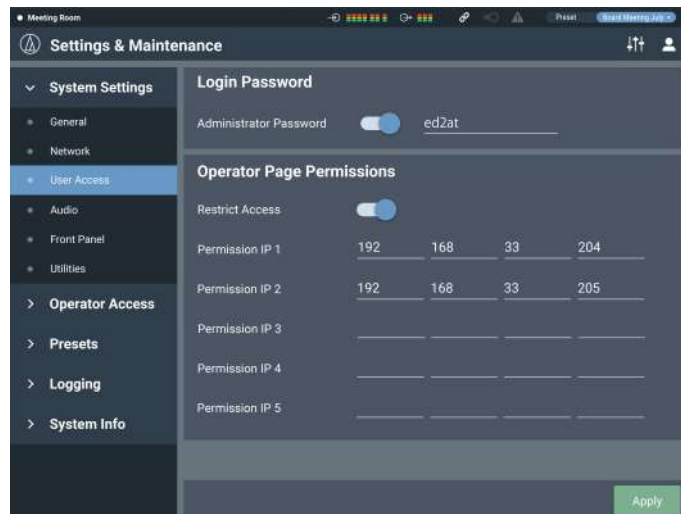

Login Password

Set whether or not to require a password for Administrator login.

1. Click the switch to turn on/off the setting.
 - The setting is turned ON (blue)/OFF (no color) each time the switch is clicked.
2. Enter a desired password.
 - Create a password using 4 to 8 alphanumeric characters.
3. Click "Apply".
 - The setting is now complete.

Operator Page Permissions

Set whether or not to limit the devices that can be accessed by the Operator.

1. Click the switch to turn on/off this function.
 - The setting is turned ON (blue)/OFF (no color) each time the switch is clicked.
2. Enter the IP addresses of the devices that can be accessed by the Operator.
 - Up to 5 devices can be registered.
3. Click "Apply".
 - The setting is now complete.
 - No other device can be accessed by the Operator.

Setting the system details (Settings & Maintenance)

Audio in System Settings

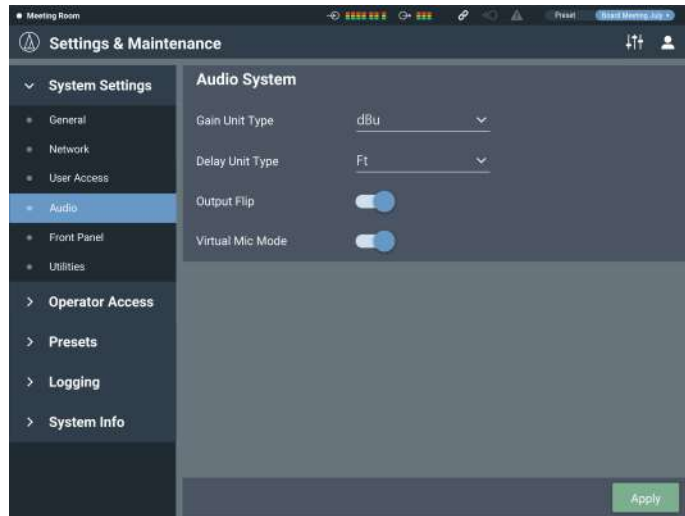

Audio System

Check/change the audio-related system settings.

1. Set each item.

Gain Unit Type	Set the unit in which the gain is displayed for adjustment.
Delay Unit Type	Set the unit in which the delay time is displayed for setting.
Output Flip	Switch the output ports.
Virtual Mic Mode	Select to include the virtual mic as an option in the input type pull-down menu.

2. Click "Apply".

- The setting is now complete.

"Output Flip"

Output of each channel assigned to an output bus is as described below.

- If "Output Flip" is turned OFF

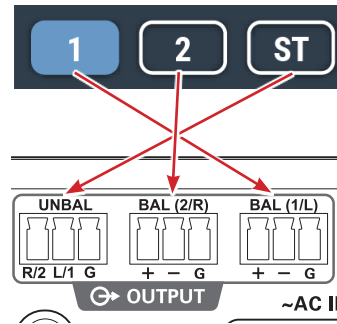

- If "Output Flip" is turned ON

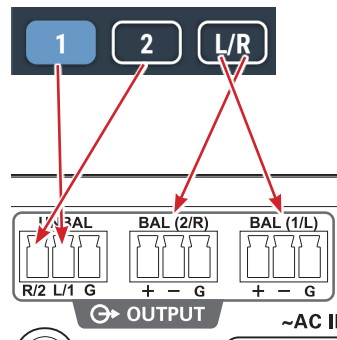

- When "Output flip" is set to ON, "OUTPUT ST" on the audio output screen changes to "OUTPUT L/R".

Setting the system details (Settings & Maintenance)

Front Panel in System Settings

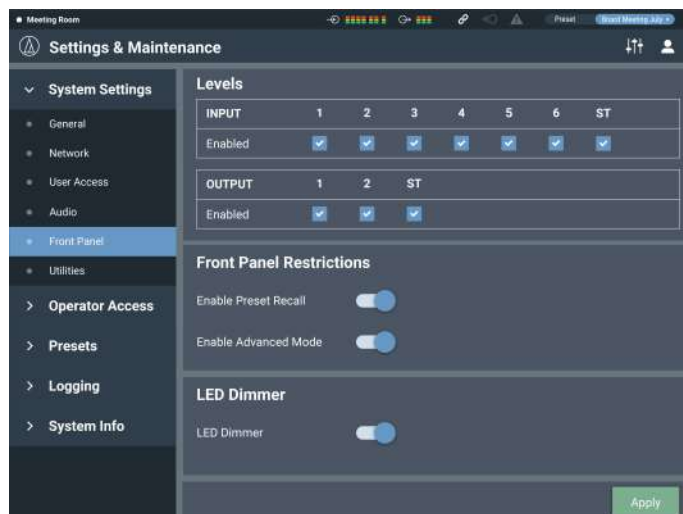

Levels

Set whether or not to enable input/output level adjustment for each channel on the front panel of the product.

1. Select/unselect the check box for each channel.
 - You can adjust the level of each selected channel.
2. Click "Apply".
 - The setting is now complete.

Front Panel Restrictions

Set the operation restrictions on the front panel of the product.

1. Set each item.

Recall Preset	Set whether or not to enable preset recall on the front panel of the product.
Entering Advanced Mode	Set whether or not to enable accessing the advanced mode on the front panel of the product.

2. Click "Apply".
 - The setting is now complete.

LED Dimmer

Set whether or not to enable dimming of the LEDs (dimmed illumination) on the front panel of the product.

1. Click the switch to turn on/off the setting.
 - The setting is turned ON (blue)/OFF (no color) each time the switch is clicked.
2. Click "Apply".
 - The setting is now complete.

Setting the system details (Settings & Maintenance)

Utilities in System Settings

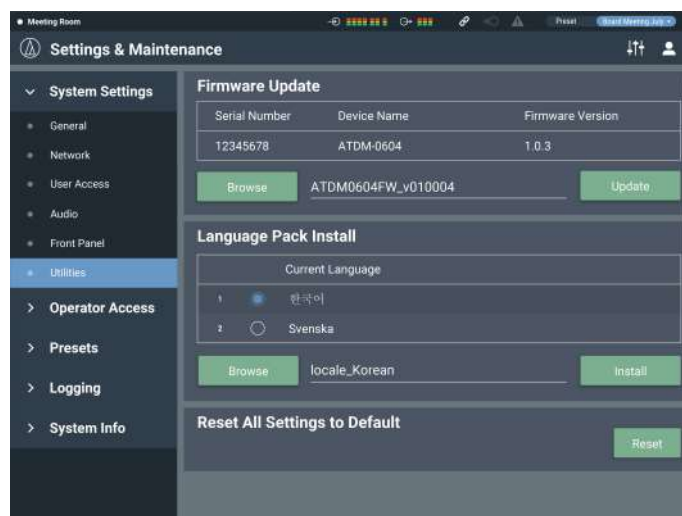

Firmware Update

Update the firmware of the product.

1. Check "Serial No.," "Device Name," and "Firmware Version" on the screen to see if this product is due for update.
2. Click "Browse".
 - The file selection screen appears.
3. Select and open the file of the latest version on the file selection screen.
4. Click "Update".
 - Update is started. When the update is complete, the completion screen appears.
5. Turn off the product, and then restart the product.
 - After the restart, reload the page in a web browser.

Reset All Settings to Default

Reset the product to the factory defaults. (The firmware will remain the current version.)

1. Click "Reset".
 - The confirmation screen appears.
2. Check the information on the confirmation screen, and click "YES".
 - When the initialization is complete, the completion screen appears. Turn off the product.

Language Pack Install

Install the language pack to allow Web Remote to be displayed in multiple languages.

1. Click "Browse".
 - The file selection screen appears.
2. Select and open the files of the desired languages on the file selection screen.
3. Click "Install".
 - Installation is started. When the installation is complete, the completion screen appears and you are automatically logged out.

Setting the system details (Settings & Maintenance)

Operator Page in Operator Access

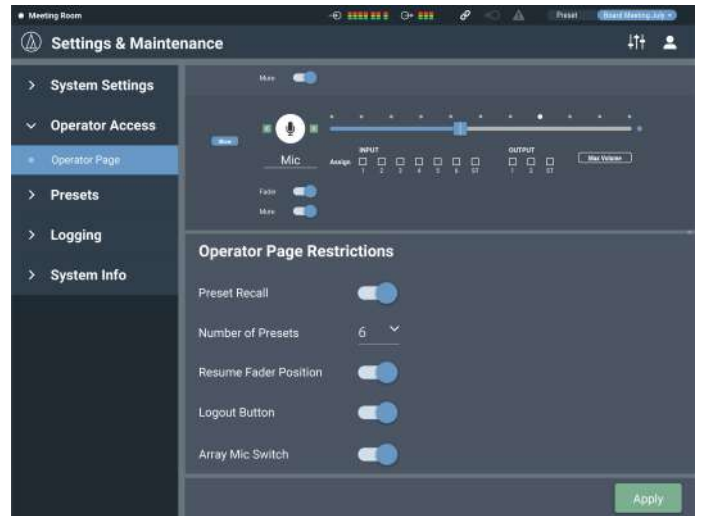
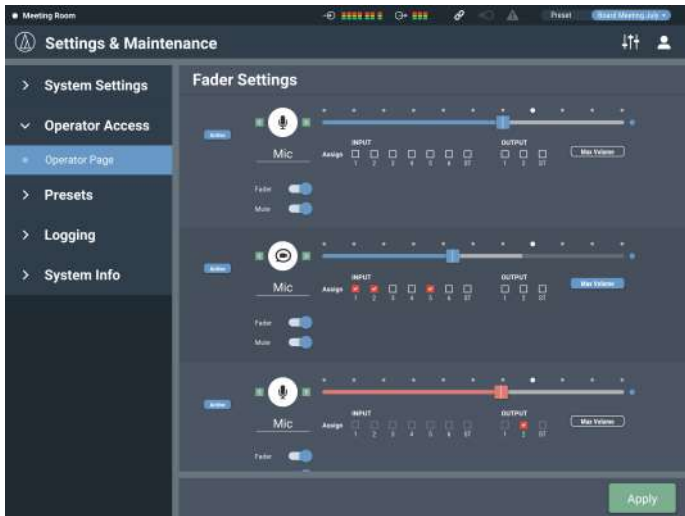

How to view the Fader Settings screen

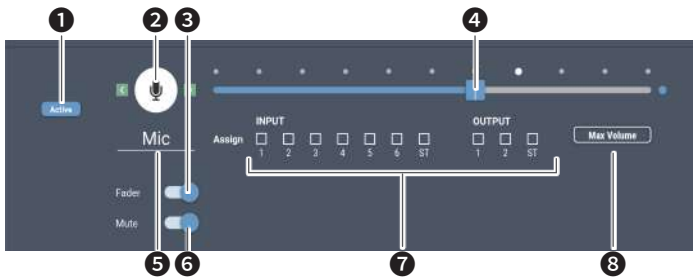

1. Select to show this screen on the Operator Page.
2. Select the icon to be displayed on the Operator Page.
3. Select to display the fader on the Operator Page.
4. Adjust the volume.
5. Set desired fader name.
6. Select to assign a mute function when the icon is clicked on the Operator Page.
7. Assign an input or output channel to the fader.
8. Set the maximum fader level.

Fader Settings

Check/change the operations that can be performed on the Operator page.

1. Set each item.
 - Set each item by referring to "How to view the Fader Settings screen."
2. Click "Apply".
 - The setting is now complete.

Operator Page Restrictions

Set restrictions on the operations that can be performed on the Operator page.

1. Set each item.

Preset Recall	Set whether or not to recall presets.
Num of Presets*	Set the number of presets that can be recalled.
Resume Fader Position	Set whether or not to enable position resume for up to eight fader channels.
Logout Button	Set whether or not to display the Log Out button on the screen.
Array Mic Switch	Set whether the array mic and LED ring can be turned on or off from the Operator Page.

* This item can be set when "Preset1.3 Recall" is turned on.

2. Click "Apply".
 - The setting is now complete.

Setting the system details (Settings & Maintenance)

Presets in Presets

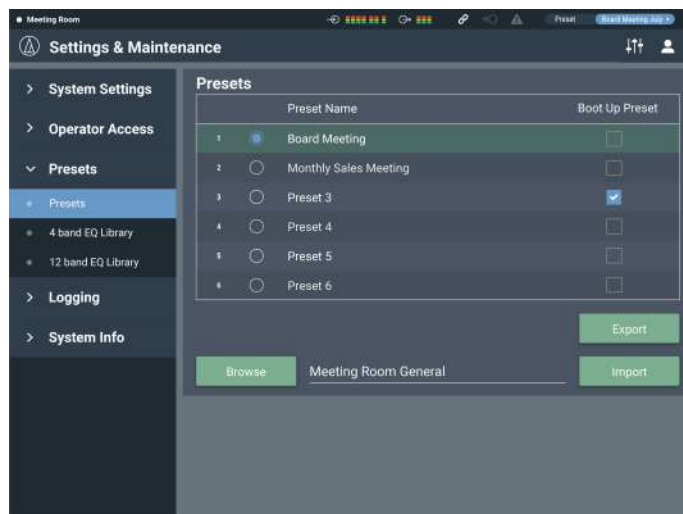

Presets

Check/change the preset settings currently registered in the product, and import/export preset files.

How to view the Presets screen

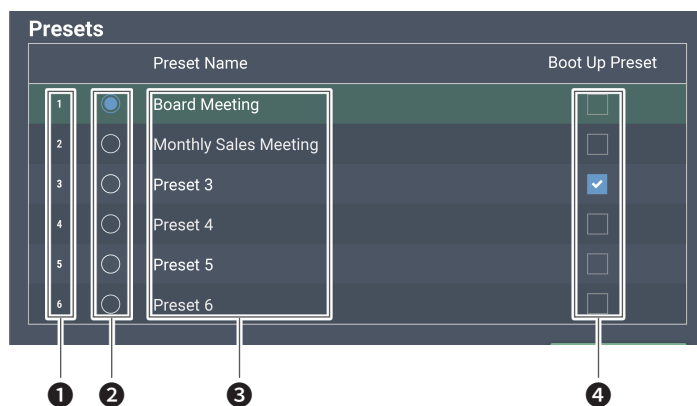

- 1 Preset number
- 2 Radio button
Select a preset.
- 3 Preset name
Set a desired name.
- 4 Boot up preset
Each time this product is started, the selected preset is recalled.

Exporting a preset

1. Click the radio button corresponding to the preset number from which you want to export.
 - Clicking the button selects the preset (the color turns to blue).
2. Click "Export".
3. Set the save location/file name, and export the file.

Importing a preset

A preset created elsewhere can be imported.

1. Click the radio button corresponding to the preset number to which you want to import.
 - Clicking the button selects the preset (the color turns to blue).
2. Click "Browse", and select the external file.
3. Click "Import".
 - The preset is imported.

Setting the system details (Settings & Maintenance)

4 Band EQ Library in Presets

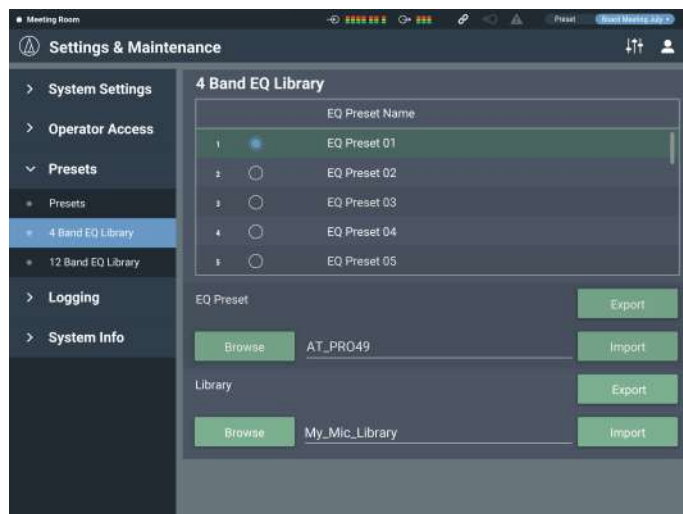

4 Band EQ Library

You can import/export 4-band EQ patterns to be applied to audio inputs as a preset.

EQ Preset	A setting in which the EQ patterns for all bands are saved.
Library	A group that includes all presets.

Changing a preset name

1. Click the preset name you want to change.
2. Enter the new preset name.

Exporting a preset/library

1. Click the radio button corresponding to the preset number from which you want to export.
 - Clicking the button selects the preset (the color turns to blue).
 - When exporting a library, you need not select all applicable presets.
2. Click "Export" from "EQ Preset"/"Library".
3. Set the save location/file name, and export the file.

Importing a preset/library

1. Click the radio button corresponding to the preset number to which you want to import.
 - Clicking the button selects the preset (the color turns to blue).
 - When importing a library, you need not select all applicable presets.
2. Click "Browse" from "EQ Preset"/"Library" and select the external file.
3. Click "Import" from "EQ Preset"/"Library".
 - The preset/library is imported.

Setting the system details (Settings & Maintenance)

12 Band EQ Library in Presets

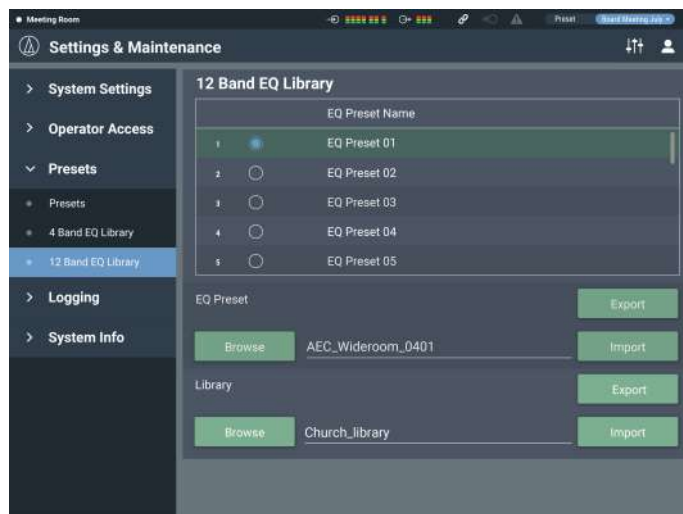

12 Band EQ Library

You can import/export 12-band EQ patterns to be applied to audio outputs as a preset.

EQ Preset	A setting in which the EQ patterns for all bands are saved.
Library	A group that includes all presets.

Changing a preset name

1. Click the preset name you want to change.
2. Enter the new preset name.

Exporting a preset/library

1. Click the radio button corresponding to the preset number from which you want to export.
 - Clicking the button selects the preset (the color turns to blue).
 - When exporting a library, you need not select all applicable presets.
2. Click "Export" from "EQ Preset"/"Library".
3. Set the save location/file name, and export the file.

Importing a preset/library

1. Click the radio button corresponding to the preset number to which you want to import.
 - Clicking the button selects the preset (the color turns to blue).
 - When importing a library, you need not select all applicable presets.
2. Click "Browse" from "EQ Preset"/"Library" and select the external file.
3. Click "Import" from "EQ Preset"/"Library".
 - The preset/library is imported.

Setting the system details (Settings & Maintenance)

Logging in Logging

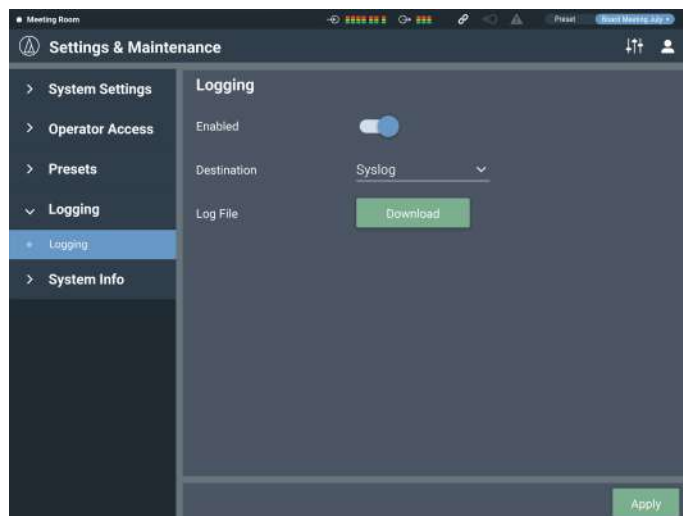

Logging

Set the options relating to log messages, and download log files.

Enabled	Set whether or not to save log messages.
Destination	Set whether to write log messages to the internal memory or transfer them to the Syslog server.
Log File	You can download the log file recorded to the internal memory by clicking "Download".

After setting each item, click "Apply" to complete the setting.

- Syslog is a standard for transferring log messages across IP networks. It is used for administration of computer systems and security monitoring.

Setting the system details (Settings & Maintenance)

System Info in System Info



System Info

System information, such as the various network settings and the product's serial number and firmware version, is displayed.

Key functions

AEC (Acoustic Echo Canceled)

In meetings held between remote locations, such as teleconferencing, acoustic echoes can occur when the audio output from the speaker is picked up by a microphone. The audio from the other party is amplified by the speaker and can bounce off of the ceiling, walls or floors of the room, and, upon being picked up by the microphone, is returned to the other party along with your party's audio. The other party hears the delayed own audio, making it difficult to speak back.

Using the other party's signals as reference signals, the acoustic echo canceler removes only the echoes in the other party's audio from the audio signals sent from your party. This makes it possible to deliver clear audio, with no echoes, to the other party.

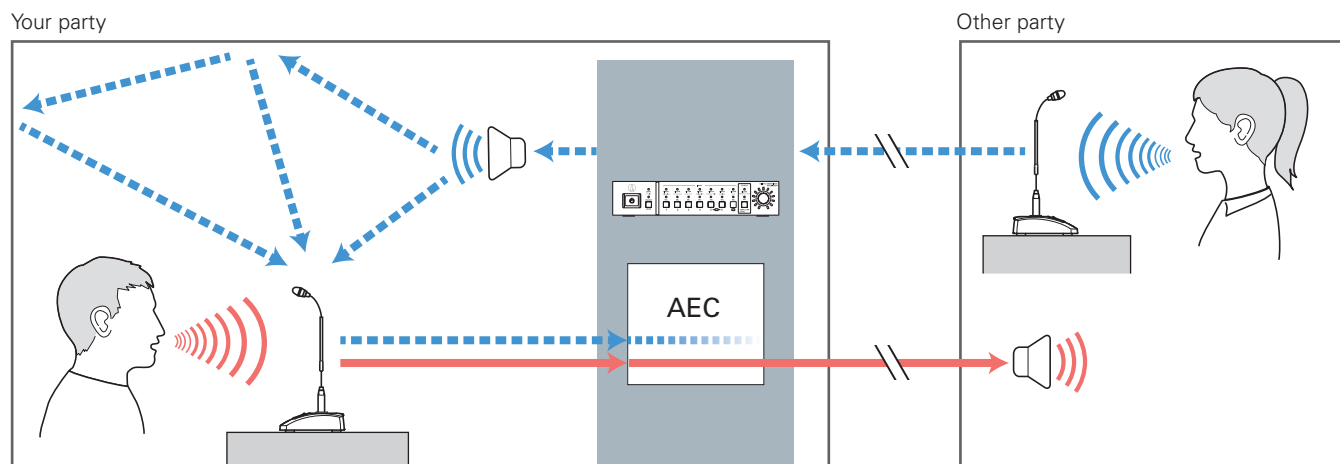

Key functions

Setting AEC

1. Click "AEC"



2. From "Mode", select "AEC"



3. From "AEC Reference", select the reference signal (the signal for removing echoes).

- In general, a signal from the other party is set as the reference signal.



4. Turn AEC ON for the Mic to be used (for each channel).



5. From "Output Bus", select the signal (output bus) to be returned to the other party.



6. Click "AEC Calibration"

- The confirmation screen appears.



Key functions

7. Click "Start":

- Reverberation measurement begins.
- Click "Test" to play the test audio for a check. Click it again to stop playing the test audio.
- If no operation is performed for some time or so, the error screen appears. Click "OK" to return to the previous screen. Repeat the procedure.

8. After the reverberation setting, confirm that the ERL meter fluctuates.

- Perform the following procedures as necessary.



9. Adjust the "Reference Level" until the ERL meter is at 10 or above.



10. If necessary, turn ON "NLP":

- These features may increase the echo canceling effect.



Saving the AEC adaptive filter setting

1. Click "Apply":

- Save the AEC adaptive filter setting.
- To save the AEC adaptive filter status also when saving a preset, click "Apply"; and then save the preset.



Key functions

SmartMixer

The SmartMixer function is designed to automatically adjust the audio input and output of the microphone channel without picking up any unnecessary noise or allowing howling to occur in meetings where an unspecified large number of participants speak at the same time. It is particularly effective in meetings, such as a panel discussion, where the participants can speak at any given time. The automation of the otherwise cumbersome fader operation by an operator makes it possible to have stable and efficient operation. SmartMixer can be either "gate mode" or "gain sharing mode".

Gate mode SmartMixer

When there is an audio input to a microphone, the corresponding channel automatically opens. If more than one microphone receives audio input, the audio inputs to all open channels are added. Simply adding the audio inputs tends to lower the howling margin, thereby reducing the audio quality. To address this issue, the gate mode SmartMixer attenuates the added audio inputs based on the number of open mic channels.

Gain sharing mode SmartMixer

This type of SmartMixer compares the audio input level of each mic channel against the total sum of the audio input levels from all open mic channels, and, based on the ratio, divides the gain among all the channels. With this, the total gain always (remains constant), whether the audio input is from one microphone or multiple microphones.

Setting Gate mode SmartMixer

Configure all settings using Web Remote.

1. Click "Smart Mix"



2. From "Mode", select "Gate"



3. Click "Enabled" for each channel that should operate with the SmartMixer function.

- It turns ON (purple) when clicked.



Key functions

4. Set "Priority", "Can Cut", and "Off Attenuation" for each channel, as necessary.

Priority	When this is set to ON, the gate of this microphone input channel opens first over the other channels whose "Priority" is OFF. <ul style="list-style-type: none"> Depending on the setting of the priority mode, the gate may not open.
Can Cut	When this is set to ON for a channel whose "Priority" is ON, the gates of the other channels whose "Priority" is OFF close upon opening of the gate of this microphone input channel.
OFF Attenuation	Set the attenuation level when the gate of the microphone input channel is closed.

Last Mic ON	When this is set to ON, the last opened microphone input channel gate remains open.
Gate Hold Time	Set the time after the audio input is ceased until the microphone input channel gate is closed.
NOMA	This function is used to attenuate the output according to the number of open microphone input channel gates. It is recommended that "NOMA" be set to ON to prevent howling.
Num of Open Mics	Limit the number of microphone input channel gates that open simultaneously. Change this value according to the operating method.
Priority Mode	Either mode of the following applies when the number of microphone input channel gates that currently open reaches the "Num of Open Mics". Mode 1: Channels cannot be opened even if their "Priority" is ON. Mode 2: Channels can be opened if their "Priority" is ON.
Fixed Threshold	This function locks the level at which the microphone input channel gate opens.
Threshold Level	Set the level at which the microphone input channel gate opens.



5. Assign signals to the output buses.

ON (Purple)	Audio signals processed by SmartMixer are output when SmartMixer is turned ON.
ON (Blue)	Assigned to an output bus. Audio signals not processed by SmartMixer are output even when SmartMixer is turned ON.
OFF	Not assigned to any output bus.



Setting gain sharing mode SmartMixer

Configure all settings using Web Remote.

1. Click "Smart Mix"



6. Set "Last Mic On", "Gate Hold Time", "NOMA", "Num of Open Mics", "Fixed Threshold", and "Threshold Level"

Key functions

2. From "Mode", select "Gain Share"



3. Click "Enabled" for each channel that should operate with the SmartMixer function.

- It turns ON (purple) when clicked.



4. Set "Weight" for each channel, as necessary.

- The gain to be distributed can be adjusted. This can be used also to balance the background noise for each channel.



5. Assign signals to the output buses.

ON (Purple)	Audio signals processed by SmartMixer are output when SmartMixer is turned ON.
ON (Blue)	Assigned to an output bus. Audio signals not processed by SmartMixer are output even when SmartMixer is turned ON.
OFF	Not assigned to any output bus.



6. Monitor the gain meter of each channel to confirm that the total gain is distributed based on the input signals.



Key functions

Audio-Technica LINK

Up to six ATDM-0604 model mixers can be daisy-chained so that, as a whole system, it can handle audio inputs from 24 Mic channels, 12 Mic/Line channels, and 6 unbalanced stereo channels. The proprietary Audio-Technica LINK functionality enables the transmission of low-latency, high-speed audio bus signals between devices, making it possible to steadily control and transmit uncompressed audio signals. Furthermore, the model offers excellent workability as it conforms to the Ethernet standards and can be connected to generic LAN cables (shielded cables of Cat5e or above with the conductor diameter size of 24 AWG or larger are recommended).

Connection and setting procedures

1. Daisy-chain the ATDM-0604 devices (up to six).

- The LINK terminal can be LINK A or LINK B. There is no distinction — and the polarity is not specific — between the two. Therefore, they can be connected in any combination : A to B, B to A, A to A, or B to B. Taking ease of maintenance after the installation into account, however, it is recommended that the terminals be connected in the same pattern within the same system.
- Do not connect the devices in a ring pattern. Make sure to leave one of the two LINK terminals at both ends of the daisy-chained ATDM-0604 devices unconnected.
- For connections, use a LAN cable of Cat5e or above with conductor diameter size of 24 AWG or larger (shielded cables are recommended).

Connection example

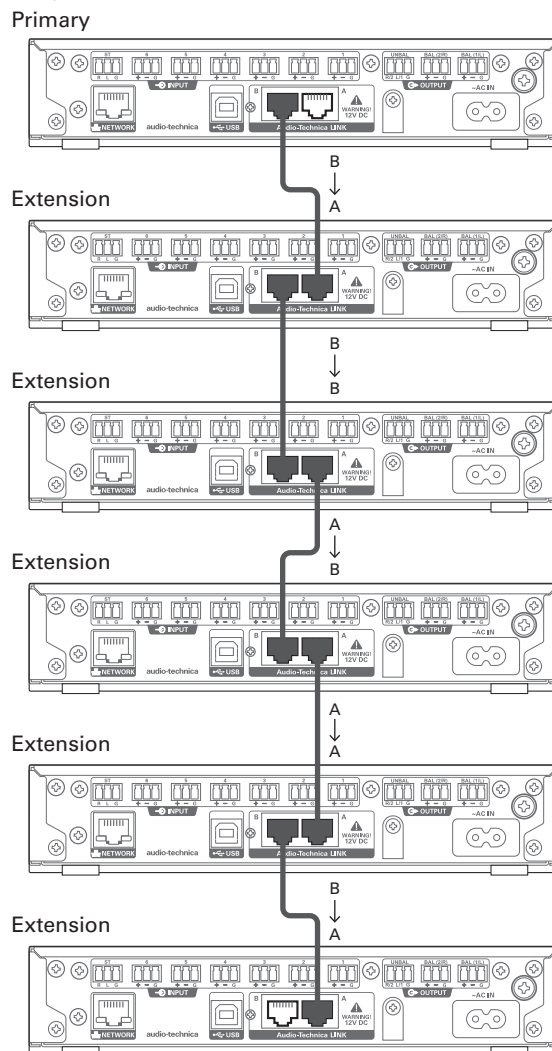

2. Launch Web Remote, and configure the settings related to the Audio-Technica LINK for each ATDM-0604.

Key functions

1. In “Audio-Technica LINK Mode”, set the ATDM-0604 connected to one of the two ends as “Primary”.
 - Do not set any of ATMD-0604 devices connected in the middle as “Primary”. The connection will not be recognized properly.

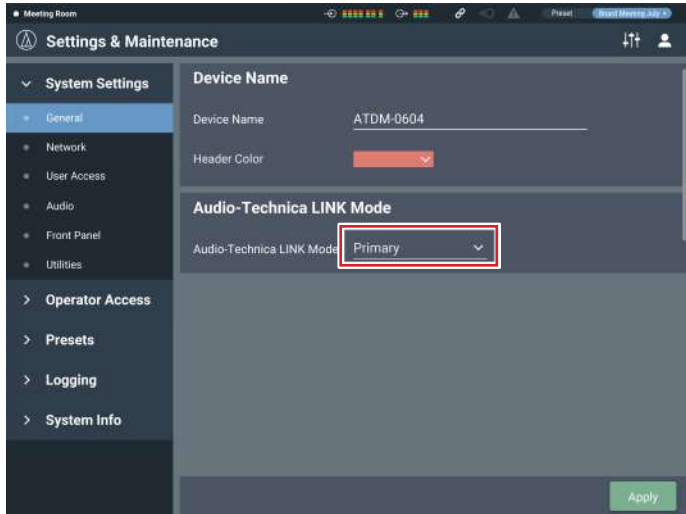

2. Set all other ATDM-0604 devices as “Extension”.
 - Do not set more than one ATDM-0604 as “Primary”.

Key functions

Sharing audio buses

In "Audio-Technica LINK," the audio output buses (Output 1/L, Output 2/R, and Output ST) and the AEC reference signal bus are shared among the ATDM-0604 devices.

With this, any ATDM-0604 can output audio inputs from 24 Mic channels, 12 Mic/Line channels, and 6 unbalanced stereo channels. The AEC reference signals can also be shared among the devices.

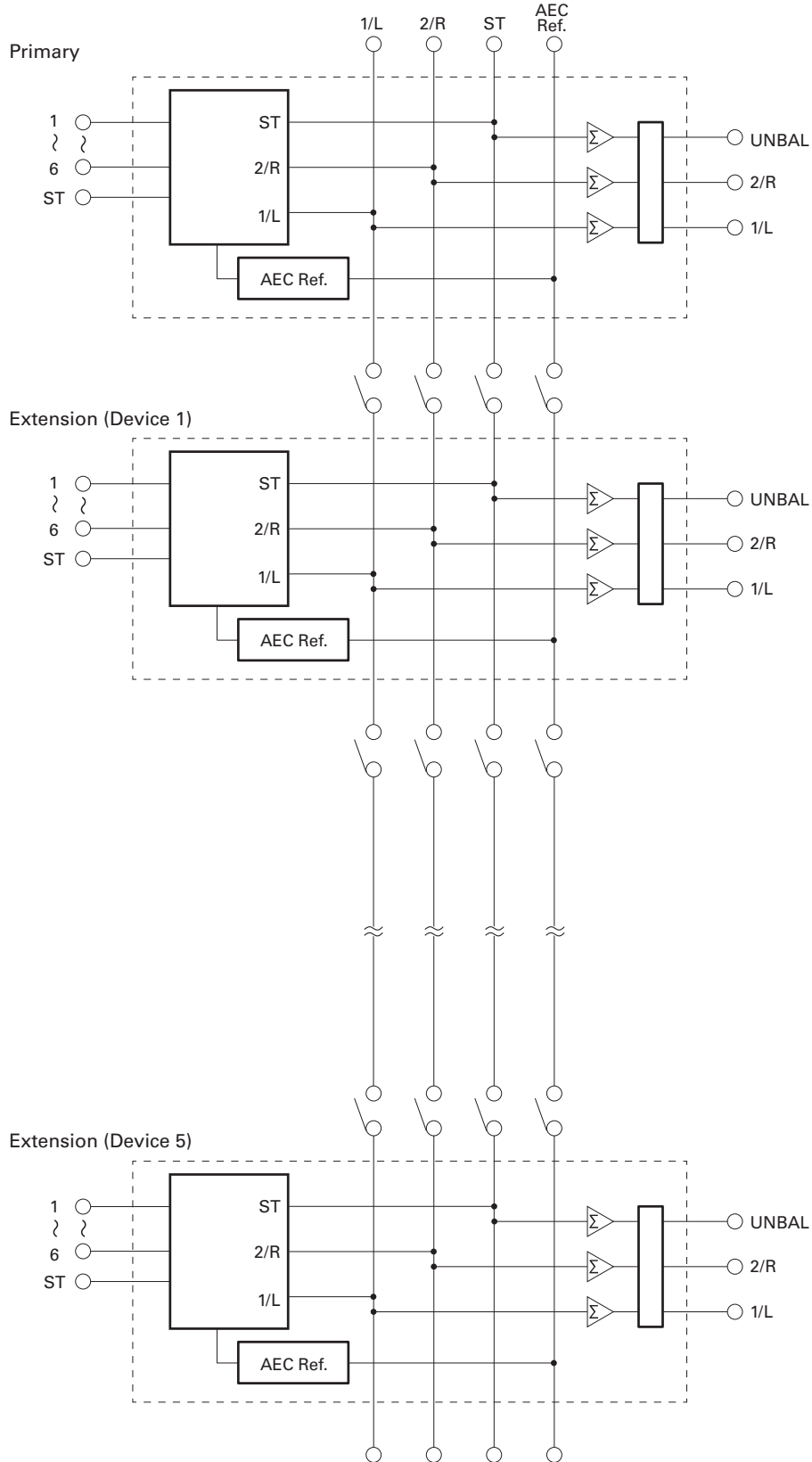

Key functions

Front panel operation restriction

The following two modes are available when operating the product with the buttons and the dial on the front panel.

Operator mode:

In this mode, daily operations are performed, such as loading the preset settings and adjusting the audio level.

Advanced mode:

In this mode, advanced settings can be configured by installing and implementing the product on-site.

When the power is turned on, the product usually starts in operator mode. This prevents accidental device setting changes or other troubles, and ensures a safe operation of the system.

This section explains how to restrict the front panel operation using Web Remote.

- The restriction cannot be activated in Advanced mode.

1. Select "Administrator," enter the password and click "Login"

- If you are logged in as an operator, log out, and then log back in.

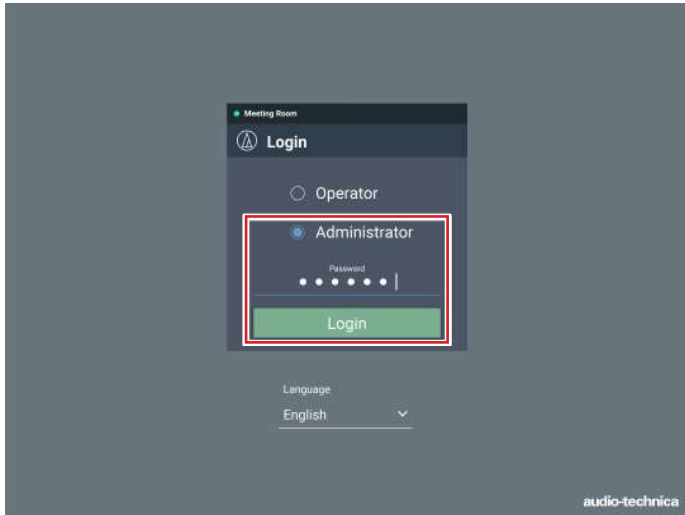

2. Click the icon (⚙️) on the top right of the screen.



3. Click "Front Panel"

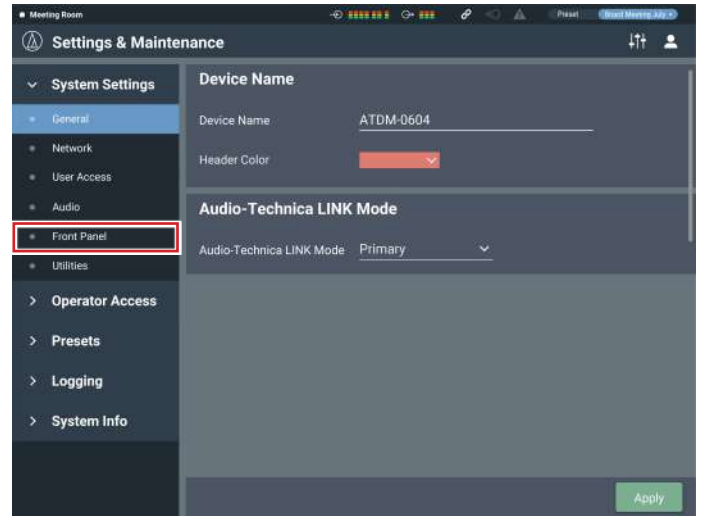

4. In the "Levels" setting, set the operation restriction for the audio level adjustment.

- If INPUT and OUTPUT for each channel are selected, the audio level for that channel can be adjusted.
- Clear the check boxes not to allow these controls.

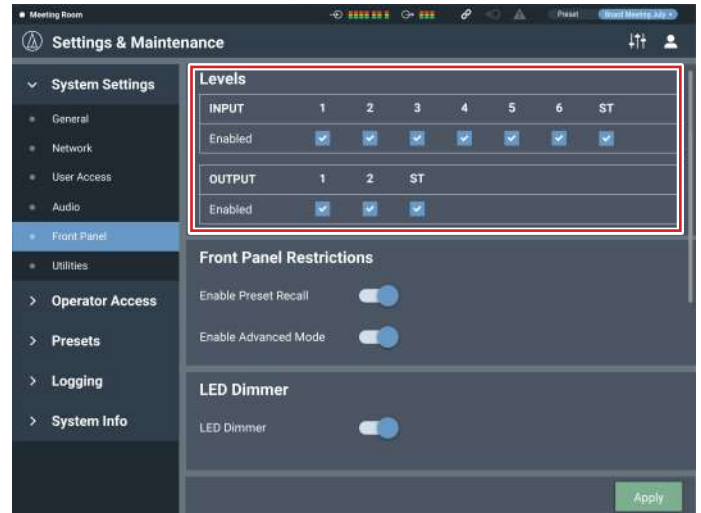

5. In the "Front Panel Restrictions" settings, configure the front panel operation restriction settings.

- The setting is turned ON (blue)/OFF (no color) each time the switch is clicked.

Enable Preset Recall	Set whether or not to enable preset recall on the front panel of the product.
Enable Advanced Mode	Specify whether or not to allow a change from operator mode to advanced mode on the front panel of the product.

6. Click "Apply"

- The setting is now complete.

Key functions

Recalling Preset

Operator screen

1. Click the green area at the top of the screen.

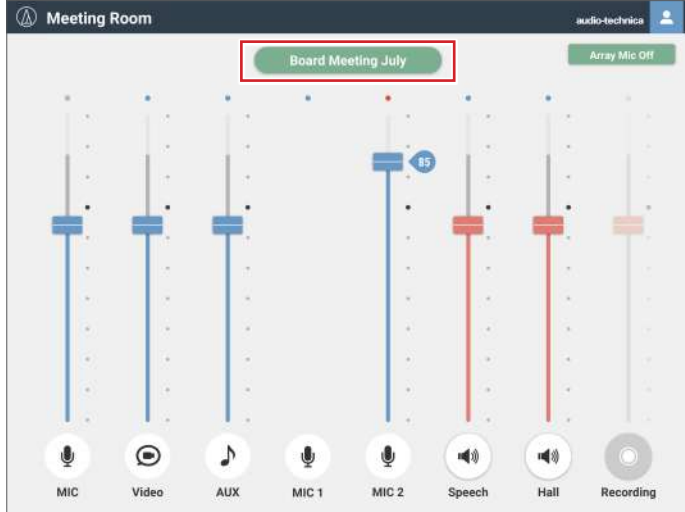

2. Select the preset of your choice from the pull-down menu.

- The preset name appears, and the settings change based on the selected preset.

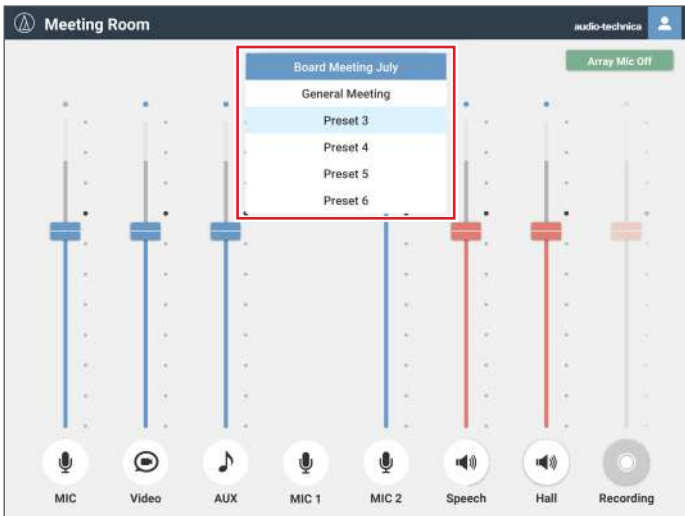

Administrator screen

1. Click "Preset" at the top right of the screen.



2. Select "Recall Preset" from the pull-down menu.



3. Select the preset of your choice.

- The preset name appears, and the settings change based on the selected preset.

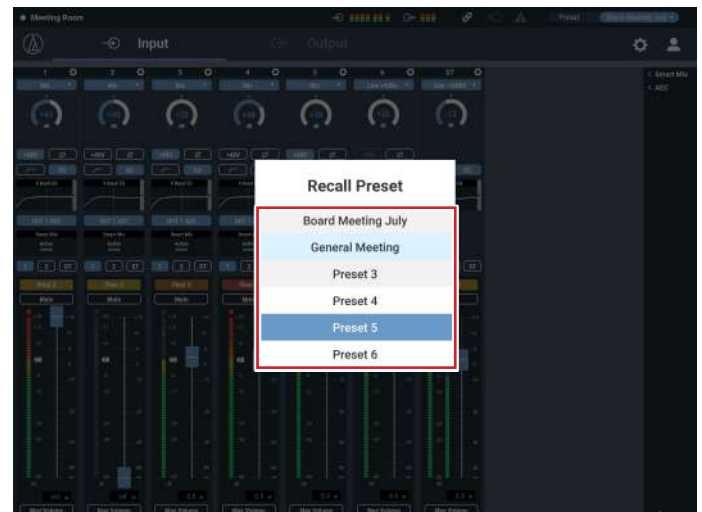

Key functions

About preset

The product includes preset patterns using a web or video conference.

Preset #1 (Initialization of audio settings)

- Reset the audio settings on the product to the factory defaults.
- All settings are deleted when initialized. Accordingly, it is recommended that the settings be saved to another preset or a hard disk space.
- The administrator password and IP address are not initialized. If you forget the administrator password or do not have the correct IP address to access the product, initialize the product system. For the system initialization procedure, refer to p. 42.

Preset #2 (Self-amplification)

This preset is suitable for self-amplification in a small- to mid-size conference room. It can also be used when amplification of the instructor with a speaker is necessary in a remote lecture or seminar. The product is equipped with a feedback suppressor for each output system to control howling. It is also equipped with a noise canceler that can reduce the fan noise generated by an air conditioning system or a projector and collect and amplify comfortable audio.

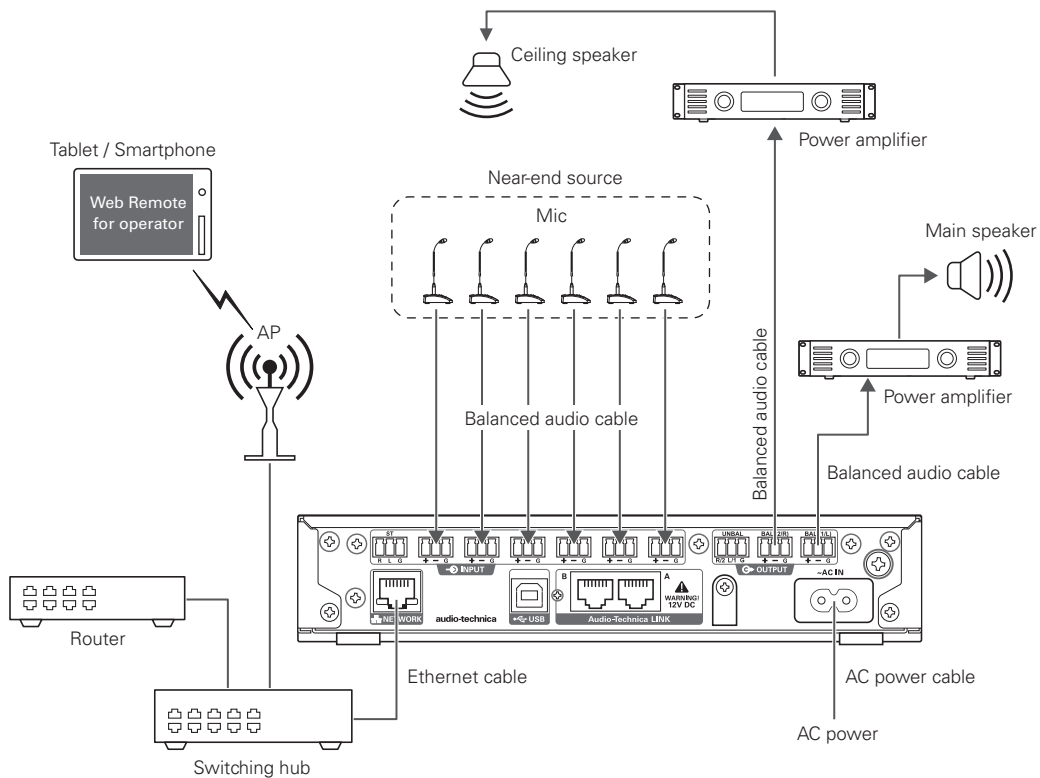

Key functions

Preset #3 (Web conference)

This preset is suitable for web conferencing using software codecs. The product, equipped with a USB audio interface, is capable of handling meetings held at any location using a computer or tablet with an Internet connection. It is also equipped with an echo canceler to provide quality conferencing with no echoes or dropouts.

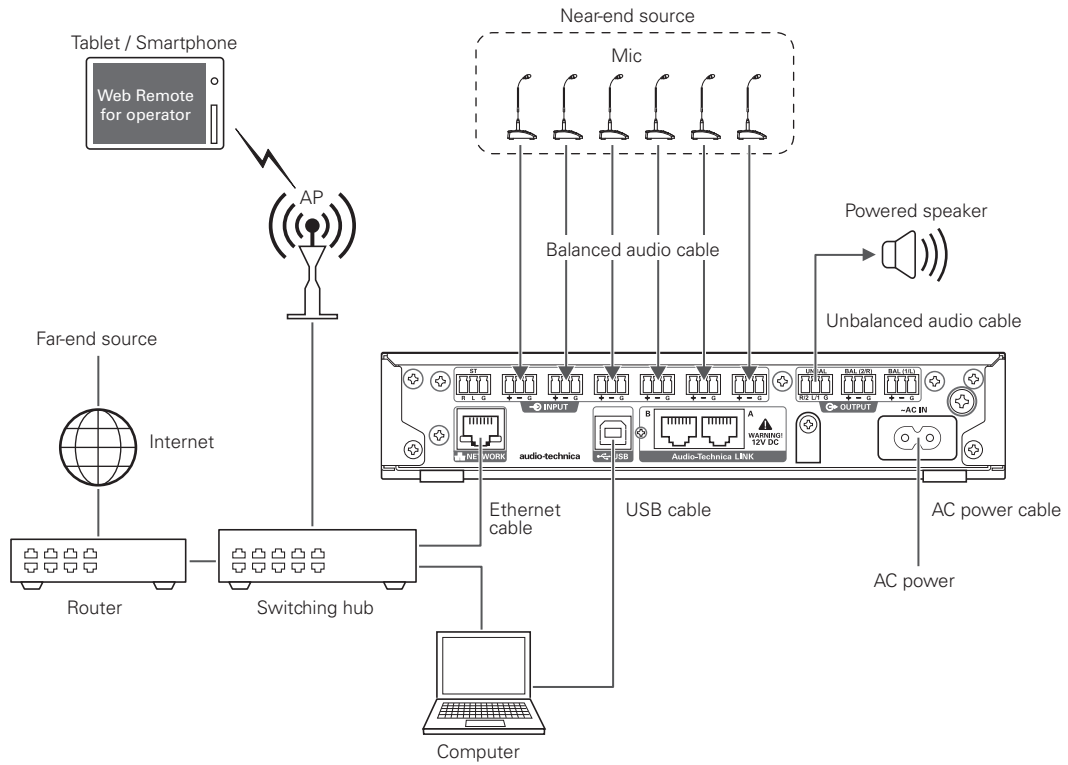

Key functions

Preset #4 (Video conference)

This preset is suitable for video conferencing using hardware codecs. The unbalanced output on this product is compatible with both Mic and Line levels, and the output level setting can be changed according to the input level of the video conference system being used. It is also equipped with an echo canceler to provide quality conferencing with no echoes or dropouts.

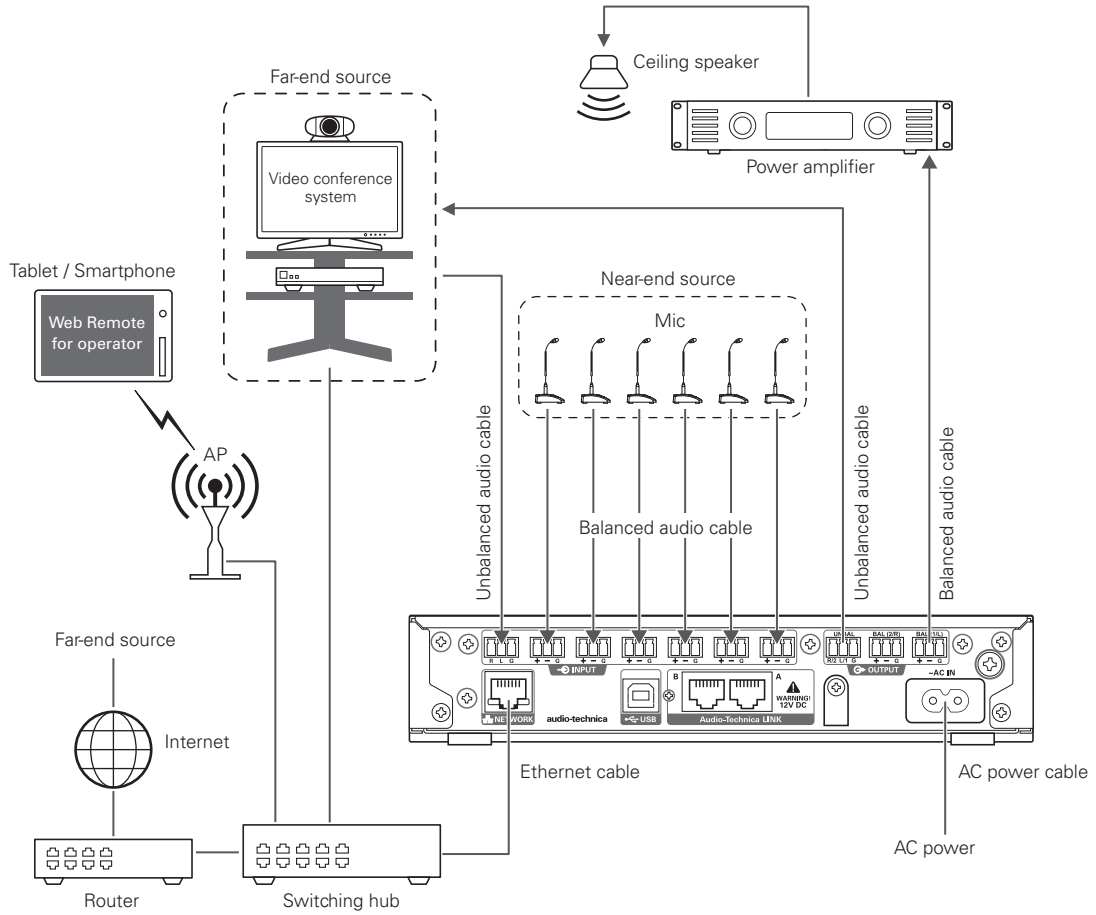

Key functions

Copying settings

The settings for a channel can be copied to another channel.

1. Click the icon (⚙️) of the source channel.



2. Click “Copy”.



3. Select the a different source channel.

- To select another channel, click the channel selected. The selection of the channel is canceled. Reselect the channel to copy.



4. Select the target channel.

- To select a different channel, click the channel selected. The selection of the channel is canceled. Reselect the target channel.



5. Click “Paste”.

- To cancel the copying, click “Cancel”. The screen returns to the previous screen.



Key functions

Resetting settings

The settings for a channel can be reset to the default settings.

1. Click the icon (⚙️) of the channel to reset.



2. Click "Reset".



Key functions

Linking channels

Link channels to share the settings. You can link only input channels 5 and 6.

1. Click the icon (⚙️) of the channels to be linked.



2. Click “Link 5&6”



3. Confirm that the input channels have been linked.

- The settings of the channel 6 are same as the settings of the channel 5.
- The linked channel 6 are grayed out and cannot be used.



Key functions

Using the ES954 (Hanging Microphone Array)

Connecting and setting the ES954

1. Connect the ES954 to ATDM-0604.

- Connect MIC1 to 4 of the ES954 to input channels 1 to 4 of the ATDM-0604.

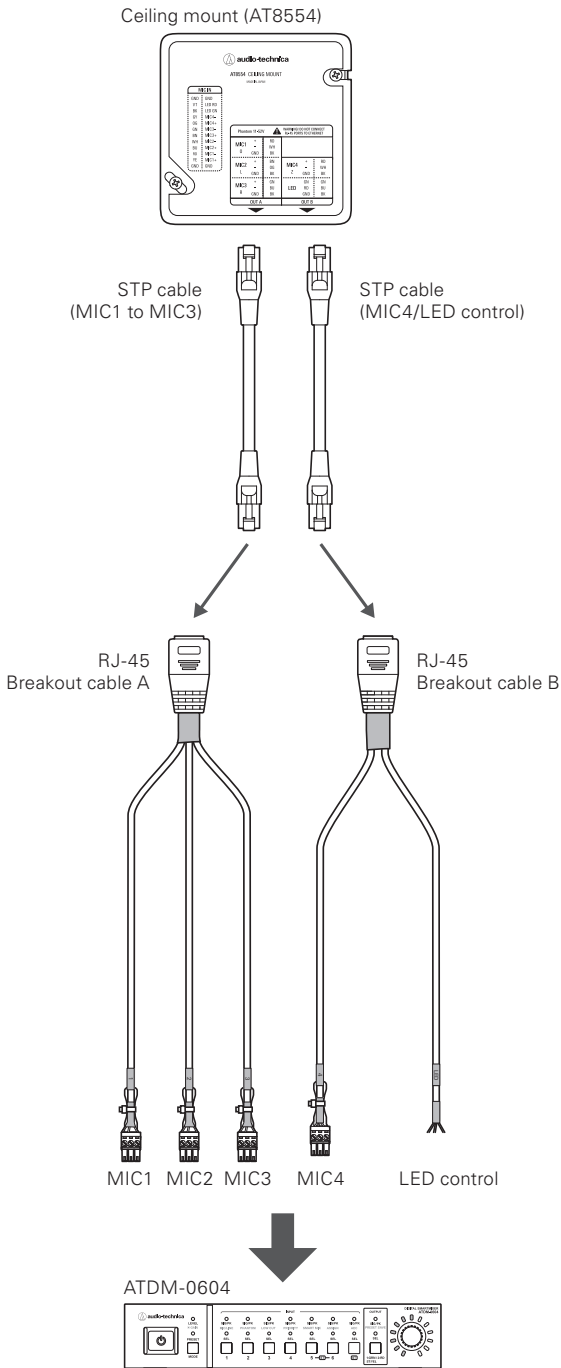

Setting the Administrator Page

1. Start Web Remote and log in as “Administrator”

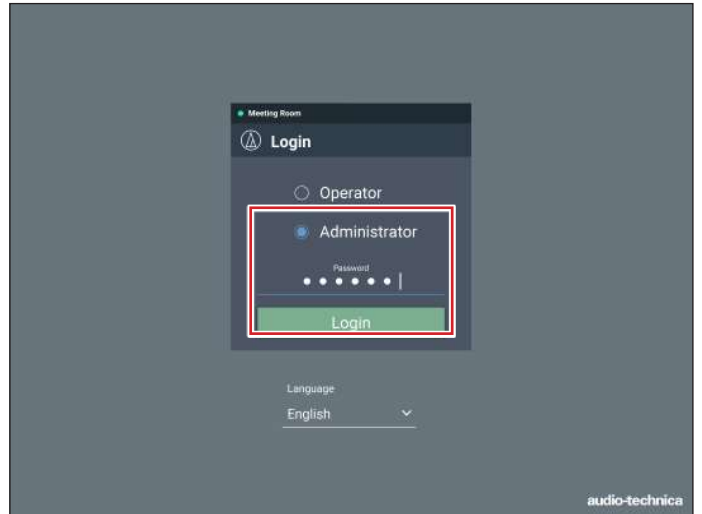

2. Click the icon (⚙️) at the upper right of the screen.



3. Click “Audio”

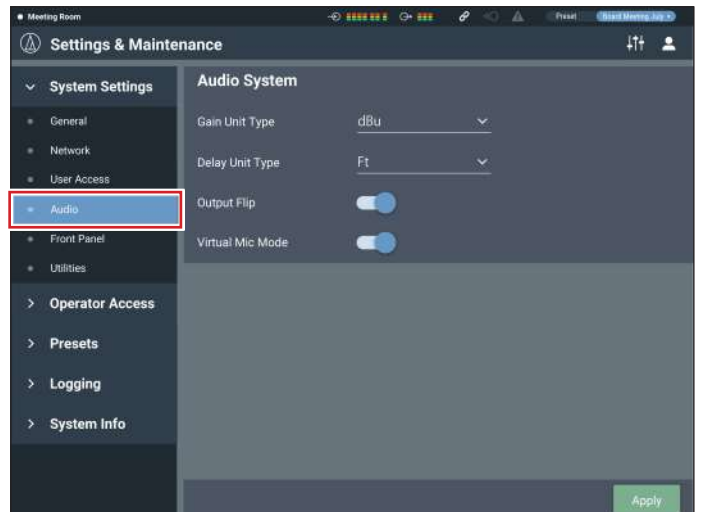

Key functions

4. Turn on "Virtual Mic Mode"

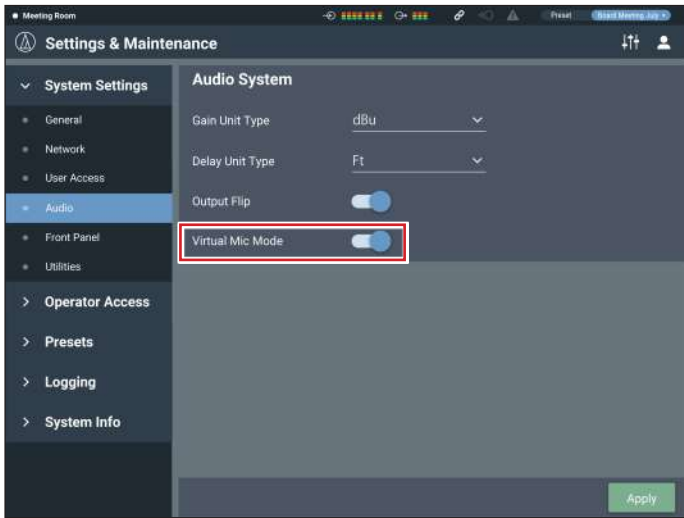

5. Click "Apply"

- The input types for input channels 1 to 4 automatically set to "Virtual Mic"
- The phantom power for input channels 1 to 4 turn "ON" automatically.

6. Click the screen switch icon (↕).

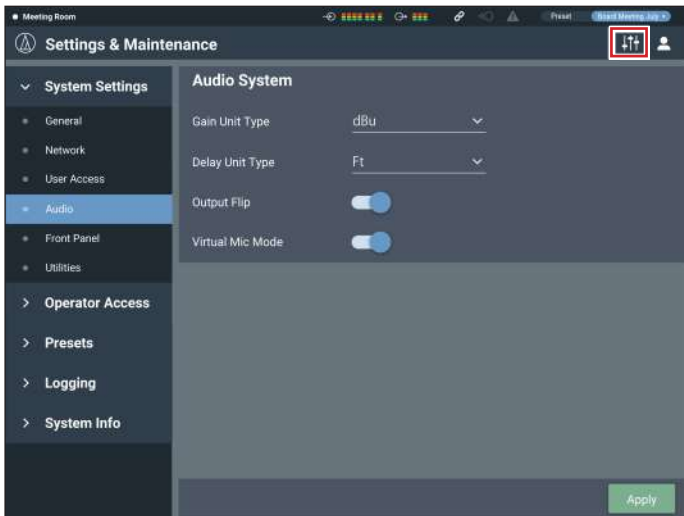

7. Set "Input gain," "Low-cut," "EQ," "Smart Mix," "Assign," and "Volume" as necessary.

- Input gain values on channels set as "Virtual Mic" are linked.
- "Low-cut," "EQ," "Smart Mix," "Bus Assignment," and "Volume" can be set for each channel.



8. Click the right side of the virtual mic box for additional settings.



Key functions

- Set the "Orientation," "Pattern," and "Tilt" of the virtual mic for each channel.

Orientation	Click the buttons around the virtual polar pattern to set the orientation of each virtual mic input channel. "Front" indicates the side that has the audio-technica logo on the ES954.
Pattern	Select "Wide," "Normal," or "OMNI" for the virtual mic polar pattern.
Tilt	Adjust the directivity of the vertical plane.



- Click the icon (⚙️) at the upper right of the screen.



- Click "Operator Page"

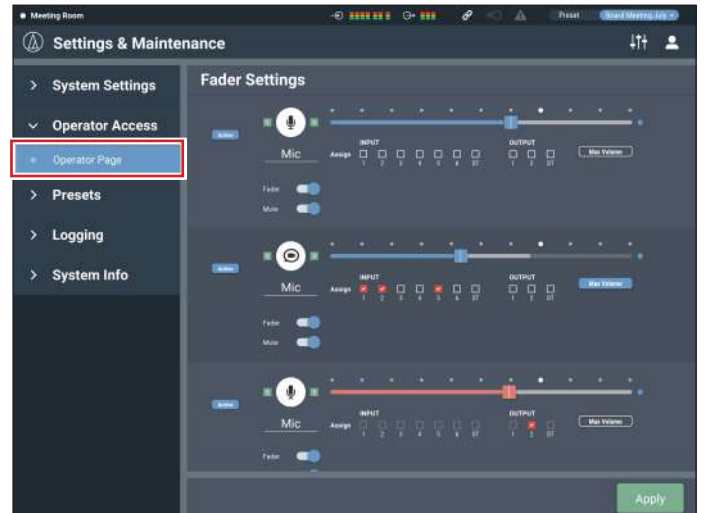

Setting the Operator Page

- Start Web Remote and log in as "Administrator"

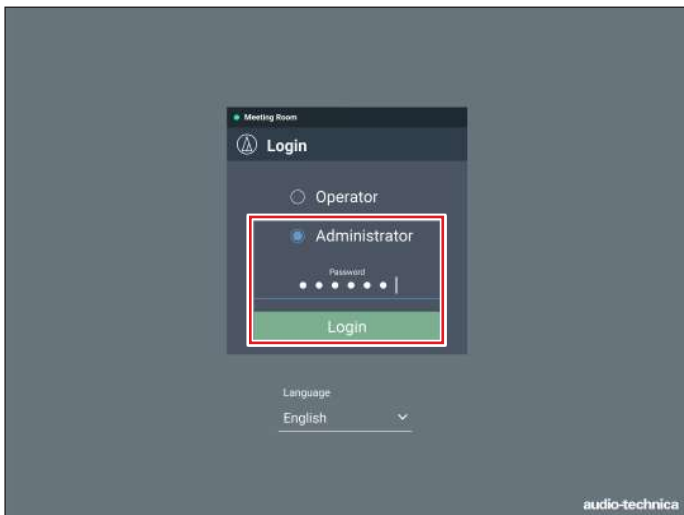

- Turn on "Array Mic Switch"

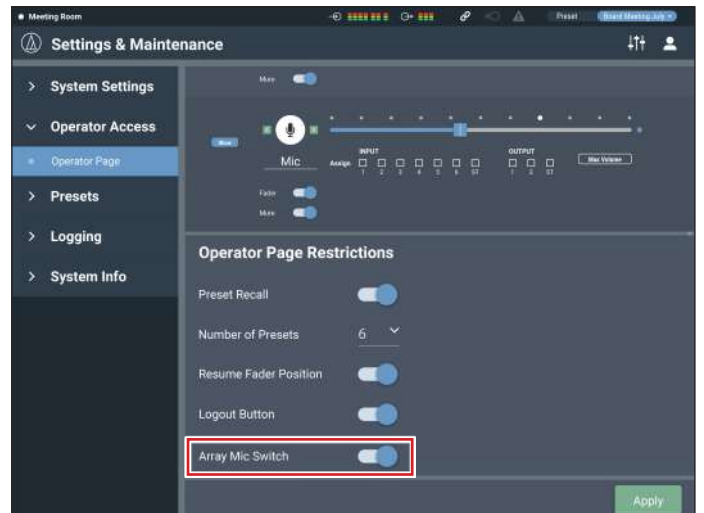

Key functions

5. Click "Apply":

- Setting is complete.

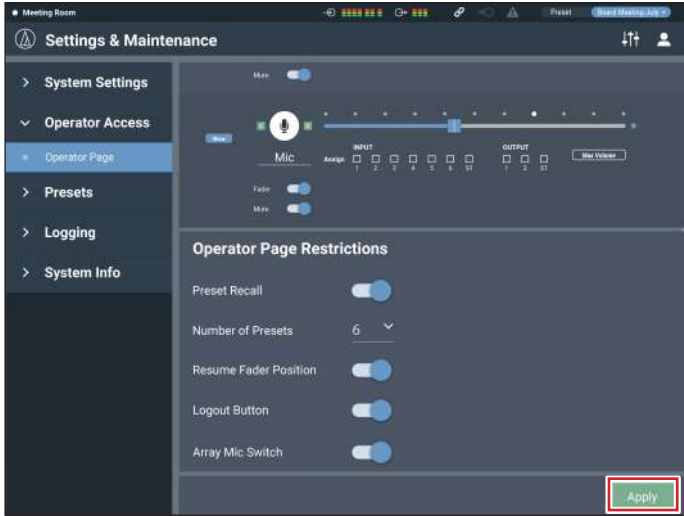

6. Log out and then log in again as an "Operator":

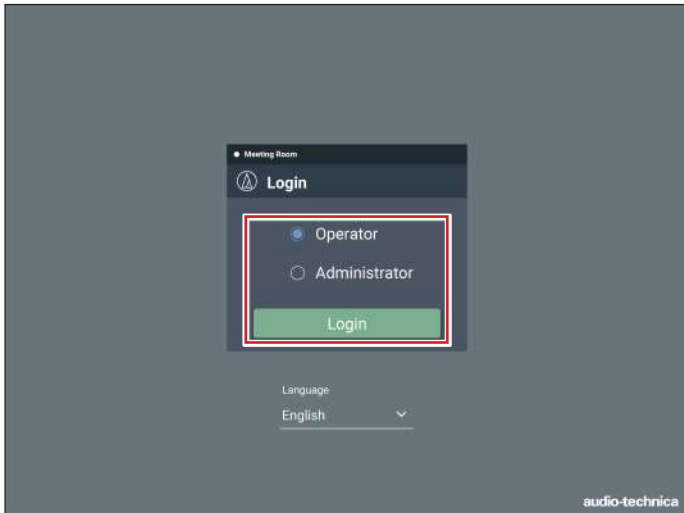

7. You can turn the array mic and LED ring on or off by clicking "Array Mic Off":

- The on or off status of the array mic is not saved. (After restarting the power, it is on.)
- The "Array Mic Off" status cannot be configured as part of a preset.

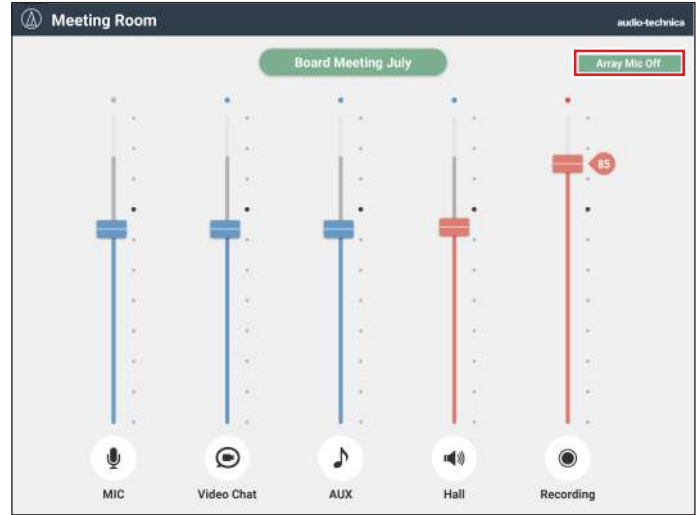

Array mic is on



Array mic is off

Key functions

Ducking function

The mixer has a ducking function on input channel ST.

The function automatically reduces the background music volume or returns it to the original volume. It is useful for situations in which background music is playing and there are announcements to be made.

Enabling Ducking

1. Start Web Remote and log in as “Administrator”

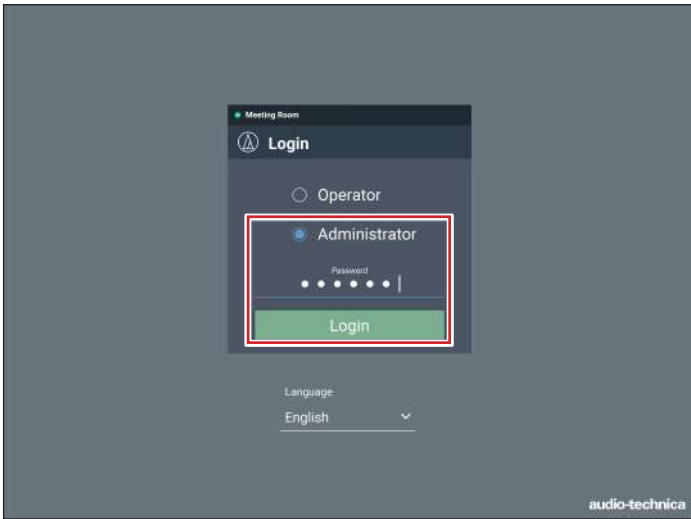

2. Click “Ducking”



3. Click “Enabled”

- The signal assigned to BUS1 becomes the trigger, and ducking is applied to input channel ST.



Menu Item

Audio Settings

Input

Item name			Setting values	Default Setting	Presets Included	Resumed
Input channel 1 to 6	CH #		CH 1 to 6	-	-	-
	Mode Select* ¹		Ch1 to 4: Mic, Virtual Mic Ch5, 6: Mic, Line 0dBV, Line +4dBu, Line -10dBV, Line -20dBV, Virtual Mic	Mic	✓	✓
	Input gain		+20dB to +60dB -20dBu to -60dBu	+20	✓	✓
	Phantom		On, Off	Off	✓	-
	Phase		On, Off	Off	✓	✓
	Lowcut (120Hz, -12dB/oct)		On, Off	Off	✓	✓
	4 Band EQ		On, Off	Off	✓	✓
	OUT 1 AEC OUT 2 AEC OUT ST AEC* ²		On, Off	Off	✓	✓
	OUT 1 NC* ² OUT 2 NC* ² OUT ST NC* ²					
	Smart Mix		Disable, Enable, Priority, Mixing	Disable	-	-
	Output 1 Bus		On, Off	Off	✓	✓
	Output 2 Bus		On, Off	Off	✓	✓
	Output ST Bus* ³		On, Off	Off	✓	✓
	Level meter		60Point + Pk.	-	-	-
	Level		-∞, -120dB to +10dB	-∞	✓	✓
	CH Name		(Maximum 10 byte)	CH 1 to 6	✓	✓
	CH Color		Green, Yellow, Brown, Red, Pink, Blue, Gray, Dark Gray	Green	✓	✓
	CH mute		On, Off	Off	✓	✓
	Link 5&6 (CH 5, 6 only)		Unlink 5&6, Link 5&6	Unlink 5&6	✓	✓
	Max Volume		On, Off	Off	✓	✓
Copy		-	-	-	-	
Reset		-	-	-	-	
Input channel ST	CH #		ST	-	-	-
	Mode Select		Line -10dBV, Line -20dBV, USB	Line -10dBV	✓	✓
	Input gain		-20dB to +20dB	0	✓	✓
	4 Band EQ		On, Off	Off	✓	✓
	Output 1 Bus		On, Off	Off	✓	✓
	Output 2 Bus		On, Off	Off	✓	✓
	Output ST Bus* ³		On, Off	Off	✓	✓
	Level meter		60Point + Pk.	-	-	-
	Level		-∞, -120dB to +10dB	-∞	✓	✓
	CH Name		(Maximum 10 byte)	AUX	✓	✓
	CH Color		Green, Yellow, Brown, Red, Pink, Blue, Gray, Dark Gray	Green	✓	✓
	CH mute		On, Off	Off	-	✓
	Max Volume		On, Off	Off	✓	✓
	Copy		-	-	-	-
Reset		-	-	-	-	
Virtual Mic	Orientation		0 to 330deg	0deg	✓	✓
	Pattern		Wide, Normal, Omni	Normal	✓	✓
	Tilt		0deg, 45deg	0deg	✓	✓
4 Band EQ	Mode change		Easy mode ⇌ Expert mode	Expert mode	-	✓
	Recall EQ Preset		-	-	✓	✓
	Easy mode	Type Select Tone	High , Mid , Low Warm, Warm-1, Warm-2, Warm-3, Warm-4, Warm-5, Warm-6, Natural, Bright-6, Bright-5, Bright-4, Bright-3, Bright-2, Bright-1, Bright	Mid Natural	✓ ✓	✓ ✓

Menu Item

Item name		Setting values	Default Setting	Presets Included	Resumed	
4 Band EQ	Expert mode	Band #1 Gain	-18dB to +18dB	0	✓	✓
		Band #1 Frequency	20Hz to 20kHz	25	✓	✓
		Band #1 Q value	0.3 to 60	0.75	✓	✓
		Band #1 Filter type	HPF, LSH, PEQ	PEQ	✓	✓
		Band #2 Gain	-18dB to +18dB	0	✓	✓
		Band #2 Frequency	20Hz to 20kHz	63	✓	✓
		Band #2 Q value	0.3 to 60	0.75	✓	✓
		Band #3 Gain	-18dB to +18dB	0	✓	✓
		Band #3 Frequency	20Hz to 20kHz	6.3k	✓	✓
		Band #3 Q value	0.3 to 60	0.75	✓	✓
		Band #4 Gain	-18dB to +18dB	0	✓	✓
		Band #4 Frequency	20Hz to 20kHz	16k	✓	✓
		Band #4 Q value	0.3 to 60	0.75	✓	✓
	Band #4 Filter type	LPF, HSH, PEQ	PEQ	✓	✓	
	Reset		-	-	-	
Smart Mix mode	Enable	On, Off	Off	✓	✓	
Gain Share	Gain Share Meter	0 to -15	-	-	-	
	Weight	-15 to 15	0	✓	✓	
Gate	Priority	On, Off	Off	✓	✓	
	Can Cut	On, Off	Off	✓	✓	
	Off Attenuation	-60db to 0dB	-40	✓	✓	

*1 "Mic" cannot be selected when selecting "Link 5&6".

When "Array Mic Switch" is enabled, Ch1 to 4 change to "Virtual Mic".

*2 When "Mode" in "AEC" is set to "NC", the screen changes to "Output L/R NC".

*3 When "Mode" in "AEC" is set to "NC", the screen changes to "Output L/R Bus".

Smart Mix

Item name		Setting values	Default Setting	Presets Included	Resumed
Smart Mix	Mode	Off, Gate, Gain Share	Gain Share	✓	✓
	Last Mic On	On, Off	Off	✓	✓
	Hold Time	0.1 to 10.0 seconds	2.5	✓	✓
	NOMA	On, Off	Off	✓	✓
	Num of Open Mics	1 to 6	6	✓	✓
	Priority Mode	Mode1, Mode2	Mode1	✓	✓
	Fixed Threshold	On, Off	Off	✓	✓
	Threshold Level	-80 to 0	-50	✓	✓

AEC

Item name		Setting values	Default Setting	Presets Included	Resumed	
AEC	Mode	Off, AEC, NC	AEC	✓	✓	
	Output Bus	1, 2, ST*	1	✓	✓	
	AEC Reference	OUT1, OUT2, OUT ST* IN 1 to 6, AUX, External	OUT1	✓	✓	
	Send Reference for External	On, Off	Off	✓	✓	
	Advanced Settings	AEC Sensitivity	Low, High	Low		
		NC Attenuation Level	0dB to 20dB	10	✓	✓
		NLP	On, Off	On	✓	✓
		NLP Sensitivity	Low, High	Low	✓	✓
	Reference Level	-60dB to +10dB	0	✓	✓	
	ERL Meter	60 Point.	-	-	-	
	ERLE Meter	60 Point.	-	-	-	
	TER Meter	60 Point.	-	-	-	
	Reference Level Meter	60 Point.	-	-	-	
AEC Calibration		-	-	-		

* When "Output Flip" is set to ON, the screen changes to "L/R".

Menu Item

Ducking

Item name				Setting values	Default Setting	Presets Included	Resumed
Ducking	Ducking			Enable, Disable	Disable	✓	✓

Output

Item name				Setting values	Default Setting	Presets Included	Resumed
CH Name				(Maximum 30 characters (ASCII code only))	OUT 1, OUT 2	-	-
Unity (Output 1/2)				+4dBu, 0dBV, -10dBV	+4dBu	✓	✓
Unity (Output ST)				-33dBV,-10dBV	-10dBV	✓	✓
Level				-∞, -120dB to +10dB	-40dB	-	-
Level meter				60 Point + Pk.	-	-	-
FBS				On, Off	Off	✓	✓
EQ				On, Off	Off	✓	✓
Dynamics				On, Off	Off	✓	✓
Delay	Enabled			On, Off	Off	✓	✓
Delay settings				0ms to 1000ms, 0.34M to 340.00M,1.12Ft to 1115.20Ft	0ms, 0.34M,1.12Ft	✓	✓
Max Volume				On, Off	Off	✓	✓
Copy				-	-	-	-
Reset				-	-	-	-

USB OUT

Item name				Setting values	Default Setting	Presets Included	Resumed
USB Out	Bus Select	OUT 1		On, Off	Off	✓	✓
		OUT 2		On, Off	Off	✓	✓
		OUT ST*		On, Off	Off	✓	✓
		AEC OUT		On, Off	Off	✓	✓
	Send Level			-∞, -120dB to 0dB	0	✓	✓

* When "Output Flip" is set to ON, the screen changes to "Output L/R".

CH Detail Setting in Output

Item name				Setting values	Default Setting	Presets Included	Resumed
Feedback Suppressor Setting	Output 1,2,ST	Band #1 to 8	Current frequency	-	-	-	-
			Band switch	On, Off	Off	✓	✓
		Reset		-	-	-	-
		Copy to 12 Band EQ		-	-	-	-
		FBS common settings	Detection		Low, Mid, High	High	✓
		Response		Slow, Fast	Fast	✓	✓
12 Band EQ Setting	Output 1,2,ST	Band #1 Enable		On ,Off	On	✓	✓
		Band #1 Gain		-18dB to +18dB	0	✓	✓
		Band #1 Frequency		20Hz to 20kHz	20	✓	✓
		Band #1 Q value		0.3 to 60	0.75	✓	✓
		Band #1 Filter type		HPF, LSH, PEQ	PEQ	✓	✓
		Band #2 Enable		On, Off	On	✓	✓
		Band #2 Gain		-18dB to +18dB	0	✓	✓
		Band #2 Frequency		20Hz to 20kHz	30	✓	✓
		Band #2 Q value		0.3 to 60	0.75	✓	✓
		Band #3 Enable		On, Off	On	✓	✓
		Band #3 Gain		-18dB to +18dB	0	✓	✓
		Band #3 Frequency		20Hz to 20kHz	60	✓	✓
		Band #3 Q value		0.3 to 60	0.75	✓	✓
		Band #4 Enable		On, Off	On	✓	✓
		Band #4 Gain		-18dB to +18dB	0	✓	✓
		Band #4 Frequency		20Hz to 20kHz	120	✓	✓
Band #4 Q value		0.3 to 60	0.75	✓	✓		

Menu Item

CH Detail Setting in Output

Item name		Setting values	Default Setting	Presets Included	Resumed
	Band #5 Enable	On, Off	On	✓	✓
	Band #5 Gain	-18dB to +18dB	0	✓	✓
	Band #5 Frequency	20Hz to 20kHz	240	✓	✓
	Band #5 Q value	0.3 to 60	0.75	✓	✓
	Band #6 Enable	On, Off	On	✓	✓
	Band #6 Gain	-18dB to +18dB	0	✓	✓
	Band #6 Frequency	20Hz to 20kHz	500	✓	✓
	Band #6 Q value	0.3 to 60	0.75	✓	✓
	Band #7 Enable	On, Off	On	✓	✓
	Band #7 Gain	-18dB to +18dB	0	✓	✓
	Band #7 Frequency	20Hz to 20kHz	1k	✓	✓
	Band #7 Q value	0.3 to 60	0.75	✓	✓
	Band #8 Q value	0.3 to 60	0.75	✓	✓
	Band #9 Enable	On, Off	On	✓	✓
	Band #9 Gain	-18dB to +18dB	0	✓	✓
	Band #9 Frequency	20Hz to 20kHz	4k	✓	✓
	Band #9 Q value	0.3 to 60	0.75	✓	✓
	Band #10 Enable	On, Off	On	✓	✓
	Band #10 Gain	-18dB to +18dB	0	✓	✓
	Band #10 Frequency	20Hz to 20kHz	8000	✓	✓
	Band #10 Q value	0.3 to 60	0.75	✓	✓
	Band #11 Enable	On, Off	On	✓	✓
	Band #11 Gain	-18dB to +18dB	0	✓	✓
	Band #11 Frequency	20Hz to 20kHz	1.6k	✓	✓
	Band #11 Q value	0.3 to 60	0.75	✓	✓
	Band #12 Enable	On, Off	On	✓	✓
	Band #12 Gain	-18dB to +18dB	0	✓	✓
	Band #12 Frequency	20Hz to 20kHz	20k	✓	✓
	Band #12 Q value	0.3 to 60	0.75	✓	✓
	Band #12 Filter type	LPF, HSH, PEQ	PEQ	✓	✓
	Flat	-	-	-	-
	Recall Library	-	-	✓	✓
	Save Library	-	-	✓	✓
	Reset all band	-	-	-	-
Dynamics Setting	Output 1,2,ST	Input Level	-	-	-
		Gain Reduction	-	-	-
		Output Level	-	-	-
		Compressor Ratio	1:1.4, 1:2, 1:4, 1:6, 1:10, 1:∞	✓	✓
		Compressor Threshold	-60dB to 0dB	✓	✓
		Compressor Attack	0msec, 0.25msec, 0.5msec, 1msec, 2msec, 4msec, 8msec, 16msec, 32msec, 100msec	✓	✓
		Compressor Release	50msec, 100msec, 200msec, 400msec, 800msec, 1000msec, 2000msec	✓	✓
		Output Gain	+10dB to -10dB	✓	✓
		Limiters Threshold	-60 to 0dB	✓	✓

Menu Item

Settings & Maintenance

System Settings

General

Item name		Setting values	Default Setting	Presets Included	Resumed
Device Name	Device Name	(Maximum 30 characters (ASCII code only))	ATDM-0604	-	✓
	Header Color	White, Green, Yellow, Orange, Purple, Cyan	White	-	✓
Audio-Technica LINK Mode	Audio-Technica LINK Mode	Primary, Extension	Primary	-	✓

Network

Item name		Setting values	Default Setting	Presets Included	Resumed
IP Setting	IP Config Mode	Auto, Static	Auto	-	✓
	IP Address	0.0.0.0 to 255.255.255.255	-	-	✓
	Subnet Mask	0.0.0.0 to 255.255.255.255	-	-	✓
	Gateway Address	0.0.0.0 to 255.255.255.255	-	-	✓
Allow Discovery	Enabled	On, Off	On	-	✓
IP Control Setting	Port Number	00001 to 65535	17300	-	✓
	Notification	On, Off	On	-	✓
	Audio Level Notification	On, Off	On	-	✓
	Multicast Address	0.0.0.0 to 255.255.255.255	225.0.0.100	-	✓
	Multicast Port Number	00001 to 65535	17000	-	✓
NTP Setting	Enabled	On, Off	Off	-	✓
	Server Address	0.0.0.0 to 255.255.255.255	-	-	✓
	Port Number	00001 to 65535	123	-	✓
	Time Zone	UTC -12:00 to +14:00	00:00	-	✓
	Daylight Saving Time	On, Off	Off	-	✓
	Start Date & Time	1/1 to 12/31, 0:00 to 23:00	3/27, 2:00	-	✓
	End Date & Time	1/1 to 12/31, 0:00 to 23:00	10/30, 2:00	-	✓

User Access

Item name		Setting values	Default Setting	Presets Included	Resumed
Login Password	Administrator Password	On, Off (Minimum 4, Maximum 8 characters (alphabet and number only))	Off	-	✓
Operator Page Permissions	Restrict Access	On, Off	Off	-	✓
	Permission IP1 to IP5	0.0.0.0 to 255.255.255.255	-	-	✓

Audio

Item name		Setting values	Default Setting	Presets Included	Resumed
Audio System	Gain Unit Type	dBu/dBV, dB	dB	-	-
	Delay Unit Type	ms, M, Ft	ms	-	-
	Output Flip	On, Off	Off	-	-
	Virtual Mic Mode	On, Off	Off	✓	✓

Front Panel

Item name		Setting values	Default Setting	Presets Included	Resumed
Levels	INPUT: 1 to 6CH, ST OUTPUT: 1, 2, ST	Enable, Disable	Enable	-	✓
Front Panel Restrictions	Enable Preset Recall	Enable, Disable	Enable	-	✓
	Enable Advanced Mode	Enable, Disable	Enable	-	✓
LED Dimmer	LED Dimmer	On, Off	Off	-	✓

Menu Item

Utilities

Item name				Setting values	Default Setting	Presets Included	Resumed
Firmware Update				-	-	-	-
Laanguage Pack Install				-	-	-	-
Reset All Settings to Default				-	-	-	-

Operator Access

Operator Page

Item name				Setting values	Default Setting	Presets Included	Resumed
Fader Settings	Fader 1 to 8	Show		On, Off	Off (Fader 1: On)	✓	✓
		Mute		On, Off	Off	✓	✓
		Fader		On, Off	Off	✓	✓
		Name		(Maximum 10 characters (ASCII code only))	Mic	✓	✓
		Icon		Mic, Aux, PC, Chat, Spk, Rec	Mic	✓	✓
		Level		0 to 100	70	✓	✓
		Max Volume		On, Off	Off	✓	✓
		Assign		INPUT: 1 to 6, ST OUTPUT: 1, 2, ST	Off (INPUT1 1: On)	✓	✓
Operator Page Restrictions	Preset Recall			On, Off	On	✓	✓
	Number Of Presets			1 to 6	6	✓	✓
	Resume Fader Position			On, Off	Off	✓	✓
	Logout Button			On, Off	On	✓	✓
	Array Mic Switch			On, Off	Off	✓	✓

Presets

Presets

Item name				Setting values	Default Setting	Presets Included	Resumed
Presets	Preset Name			(Maximum 30 Byte)	Preset 1 to 6	✓	-
	Boot Up Preset			1 to 6, Non	Non	-	✓

4 Band EQ Library

Item name				Setting values	Default Setting	Presets Included	Resumed
4 Band EQ Library	EQ Preset Name			(Maximum 30 Byte)	EQ Preset 01 to 20	-	✓

12 Band EQ Library

Item name				Setting values	Default Setting	Presets Included	Resumed
12 Band EQ Library	EQ Preset Name			(Maximum 30 Byte)	EQ Preset 01 to 20	-	✓

Logging

Logging

Item name				Setting values	Default Setting	Presets Included	Resumed
Logging	Enabled			On, Off	On	-	✓
	Destination			Internal, Syslog	Internal	-	✓
	Log File			-	-	-	-

System Info

System Info

Item name				Setting values	Default Setting	Presets Included	Resumed
System Info				-	-	-	-

Troubleshooting

If you encounter a problem, please check the following.

- Check whether all connections are correct.
- Check whether the system is being operated according to the instructions provided in the manual.
- Check whether the external devices are functioning properly. Check the devices without connecting them to the product.
- Restart the network devices.

If any of the devices in the system are not functioning properly, check the troubleshooting tips below.

If none of the tips apply, please contact your local Audio-Technica dealer.

You may be asked to provide the version of your firmware. Please check in advance and have the firmware version handy.

To find the firmware version on the product: Refer to p. 17.

To find the firmware version via Web Remote: Refer to p. 42.

ATDM-0604 unit

p. 15, p. 25	Cause/Action	Reference page
The power does not turn on.	Check whether the power cable is connected correctly.	-
The connected microphone does not function.	Check whether the microphone is connected correctly.	-
	Check whether Mic is selected as the input type (Mic/Line).	p. 15, p. 25
	Check whether the phantom power is turned on when using a condenser microphone.	p. 15, p. 25
	Check the gain.	p. 15, p. 25
	Check the input level.	p. 15, p. 28
No sound comes out of the connected speaker. The sound is distorted.	Check the connections of all devices.	-
	Check whether the phantom power is turned on when using a condenser microphone.	p. 15, p. 25
	Check whether a device that does not require phantom power is connected with the phantom power turned ON. If phantom power is supplied to a device that does not require it, the device may malfunction.	-
	Check and adjust the settings on the connected amplifier.	-
	Check whether the balanced cable is damaged.	-
	Make sure that the balanced cable is securely inserted all the way.	p. 9
	Check whether the input and output terminals are connected correctly.	-
	Check whether the pin assignments are correct for the input and output terminals.	-
	Check that the input level and/or the output level is not set too low.	p. 15, p. 28, p. 35
Check whether mute is turned ON.	p. 28	
The sound is strange.	Adjust the input gain.	p. 15, p. 25
	If the sound is muffled or the volume is not sufficient, check the setting of each equalizer.	-
The howling cannot be suppressed.	Check the setting of the FBS (feedback suppressor). If howling that exceeds the number of filters is occurring, the howling cannot be controlled completely. Lower the speaker volume.	p. 30
The buttons on the front panel do not react.	Check that the front panel is not locked.	p. 17

Troubleshooting

Web Remote

Symptom	Cause/Action	Reference page
You cannot "locate" the product.	Check the connections of the product and the control device, such as a computer.	-
	Check whether the product and the control device, such as a computer, are connected to the same network.	-
	Check the firewall settings.	-
Web Remote cannot be opened from a control device, such as an iPad or another tablet.	Check whether the control device is connected to the correct access point.	-
	Check whether the product and the control device, such as an iPad or another tablet, are connected to the same network.	-
You forgot the password.	<p>Reset the password based on the following procedure.</p> <ol style="list-style-type: none">1. Press the power button to start the product.2. Press the MODE button, or turn the dial button while pressing the MODE button, to select "PRESET".3. While pressing the OUTPUT SEL button, turn the dial button three clicks to the right.4. While pressing the OUTPUT SEL button, turn the dial button three clicks to the left.5. While pressing the OUTPUT SEL button, press the dial button. <p>The Web Remote password is reset. Login again to Web Remote and set the password again as needed..</p>	-

Error messages

Error Message	Cause	Action
Resume Data Error	Importing the resume data failed. The product started with the previous or default settings.	Restart the product, and check whether the same error occurs.
Preset Data Error	Importing the preset data failed. The preset data is the one that was successfully imported last time or the default.	Restart the product, and check whether the same error occurs.
Library Data Error	Importing the EQ library data failed. The product started with the previous or default settings.	Restart the product, and check whether the same error occurs.
Audio-Technica LINK Connection Error	An error occurred during the communication with an ATDM-0604 that is connected via Audio-Technica LINK. The operation of Audio-Technica LINK was stopped.	Check for any network connection problem.
Audio-Technica LINK OFF	The Audio-Technica LINK was canceled, and its operation was stopped.	Check for any network connection problem.
Detect Exceeded Link Units	The number of ATDM-0604 units connected exceeded the maximum number of units that can be connected. The operation of Audio-Technica LINK was stopped.	Check the number of units connected.
Detect Multi Primary Units	More than one primary unit of ATDM-0604 were detected. The operation of Audio-Technica LINK was stopped.	Set only one ATDM-0604 unit as the primary.
Detect Ring Connection	A ring connection was detected. The operation of Audio-Technica LINK was stopped.	Do not connect units in a ring pattern. Make sure to leave one of the two LINK terminals at both ends of the connected ATDM-0604 devices open.
Network Communication Error	A network communication error occurred.	Check for any network connection problem.
	An IP command communication error occurred.	
Access from Non Permitted Device	A device not permitted to access was connected.	Check for any network connection problem.
File Import Failed	Importing the preset file failed.	<ul style="list-style-type: none"> • Check whether the file format is correct. • The network connection may have been disconnected.
File Export Failed	Exporting the preset file failed.	The network connection may have been disconnected.
Failed	An unknown system failure occurred.	Perform the operation again, and check whether the same error occurs.
Failed. Please turn power OFF.	An error occurred during the firmware update.	Restart the product, and check whether the same error occurs.
Data acquisition error.	Acquisition of data via web remote failed.	Perform the operation again, and check whether the same error occurs.
USB Disconnected	The USB connection with the PC is not established.	<ul style="list-style-type: none"> • Check whether the USB connection with the PC is proper. • Connect the USB to another PC, and check whether the same error occurs.
Synchronous Disconnect	Synchronization with the PC failed.	<ul style="list-style-type: none"> • Check whether the USB connection with the PC is proper. • Connect the USB to another PC, and check whether the same error occurs.
Cannot COPY	The data cannot be copied because the EQ preset is full.	Check whether there is space in the EQ preset.
	Copying of the bands in static state to the 12-band EQ failed.	The bands for which EQ is set to OFF on the 12-band EQ side are to be copied. Check the settings.
Cancel Time is not enough.	The result of the reverberation measurement is 160 ms or longer.	The screen prompts to confirm whether or not to change the AEC response to LOW. Check the settings based on the instructions on the screen.
AEC doesn't work	AEC is not functioning properly.	Check the AEC settings.
Time out Error.	A time out error occurred during an AEC reverberation measurement.	Perform the measurement again.

Dimensions

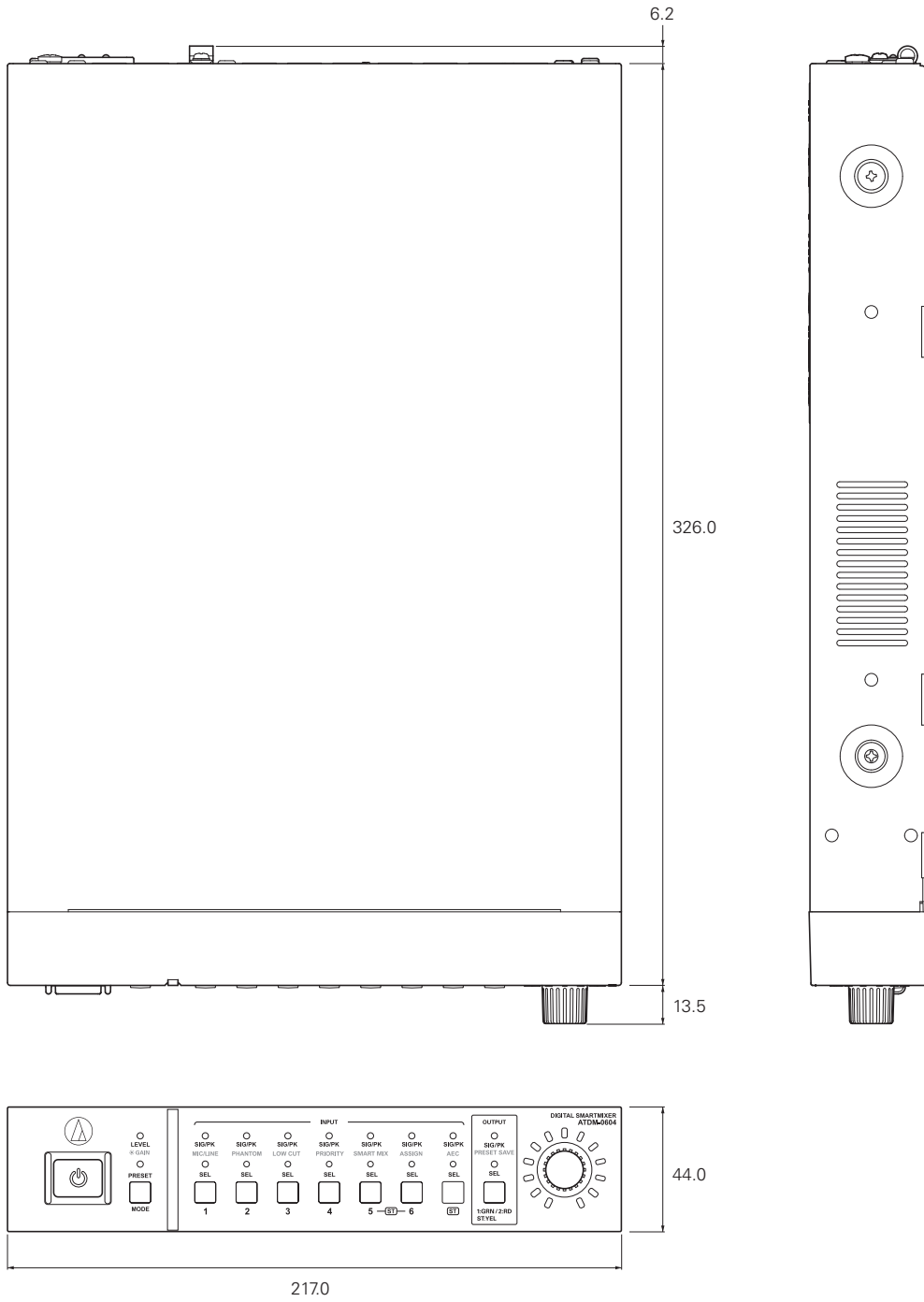

(Unit: mm)

Specifications

General specifications

Power supply		100 to 240 V AC (50/60 Hz)
Power consumption		17 W
Operating temperature range		0 to 40°C (32 to 104° F)
Operating humidity range		25 to 85% (with no condensation)
Dimensions (excluding protrusions)		217 mm (8.54") x 44 mm (1.73") x 326 mm (12.83") (W×H×D)
Weight		1.85 kg (4.1 lbs)
Finish	Front panel	Black with silver lines
	Top/rear/sides	Black

Audio

Frequency characteristics	20 Hz to 20 kHz (MIC -16 dBu)	+1.0/-1.0 dB
	20 Hz to 20 kHz (MIC -60 dBu)	+1.0/-2.0 dB
	20 Hz to 20 kHz (LINE 24 dBu)	+1.0/-1.0 dB
	20 Hz to 20 kHz (LINE -40 dBu)	+1.0/-2.0 dB
Dynamic range		110 dB or higher, A-weighted/ST
S/N ratio		90 dB or higher, A-weighted/ST
Headroom		20 dB or higher
Input referred noise		-126 dBu or less, Rs = 150 ohm, DIN
Common-mode rejection ratio		80 dB or higher, 1 kHz
Residual noise		-86 dBu or less, A-weighted
Maximum gain		64 dB
Channel separation		-80 dB or less, 1 kHz unity
Total harmonic distortion		0.03% or less, 1 kHz unity
Analog input	MIC max.	0 dBu
	MIC unity	-40 dBu
	LINE max.	+24 dBu
	LINE unity	+4 dBu/0 dBV/-10 dBV/-20 dBV
	ST max.	+10 dBV
	ST unity	-10 dBV/-20 dBV
Analog output	UNBAL max.	+10 dBV/-13 dBV
	UNBAL unity	-10 dBV/-33 dBV
	BAL 1/L and 2/R max.	+24 dBu/20 dBV/+10 dBV
	BAL 1/L and 2/R unity	+4 dBu/0 dBV/-10 dBV

Specifications

Other

Phantom power		+48 VDC
PAD (Attenuation level)		-24 dB
I/O connector	INPUT ST	Euroblock connectors (3-pin)
	INPUT MIC/LINE 5 and 6	Euroblock connectors (3-pin)
	INPUT MIC 1 to 4	Euroblock connectors (3-pin)
	OUTPUT UNBAL	Euroblock connectors (3-pin)
	OUTPUT BAL 1/L and 2/R	Euroblock connectors (3-pin)
Level indicator	SIGNAL/PEAK	1 point (Red/Yellow/Green)
	Peak indicate (red)	-5 to 0 dB
	Peak hold time	2 sec
Remote control	IP protocol	RJ-45×1 pc
	IP address	192.168.33.102 (factory default)
	Communication speed	100 Mbps
Link I/O	IP protocol	RJ-45×2 pcs
	Communication speed	100 Mbps
USB Type B	Channel	Stereo input x 1 ch, stereo output x 1 ch (24-bit)
	Communication speed	High-speed (480 Mbps)
A/D converter	Resolution	24-bit
	Dynamic range	115 dB
D/A converter	Resolution	24-bit
	Dynamic range	115 dB
Accessories		Euroblock connector x 10, Rack-mount (large, small), Rack-mount screw x 6, Power cable, Rubber feet x 4

Input/Output specifications

Analog input specifications

Input terminal	Gain	Load impedance	Input level			Connector	Balanced/Unbalanced	
			Minimum value	Nominal value	Maximum value			
MIC 1 to 4	20 to 60 dB	1.6 kΩ	-60 dBu	-40 dBu	-20 dBu	Euroblock connector	Balanced	
MIC/LINE 5 and 6	MIC	20 to 60 dB	1.6 kΩ	-60 dBu	-40 dBu	-20 dBu	Euroblock connector	Balanced
	LINE	20 to 60 dB	10 kΩ	-40 dBu	+4 dBu / 0 dBV / -10 dBV / -20 dBV	+24 dBu	Euroblock connector	Balanced
ST (L/R)	-	10 kΩ	-	-10 dBV / -20 dBV	+20 dBV	Euroblock connector	Unbalanced	

Analog output specifications

Output terminal	Load impedance	Output level			Connector	Balanced/Unbalanced
		Minimum value	Nominal value	Maximum value		
UNBAL (L/R)	150 Ω	-	-33 dBV / -10 dBV	-13 dBV / +10 dBV	Euroblock connector	unbalanced
BAL 1/L and 2/R	150 Ω	-	-10 dBV / 0 dBV / +4 dBu	+10 dBV / +20 dBV / +24 dBu	Euroblock connector	Balanced

System diagram

