



SUNPASS INTERNATIONAL, YUYAO
ADDRESS: No. 78 West Road Zhenxing, Lianghui Economic Zone,
Yuyao, Zhejiang, 315403, China
Tel: 86 574 62837600 62837602 62837603
Fax: 86 574 62837601
Email: sales@sunpass.biz
www.sunpass.biz

TANK CONTAINER SPARE PARTS

SunPass[®]

CATALOGUE

SUNPASS is a leading manufactory, developer, and supplier of quality ISO tank container spare parts for tank container operators, services, agents, trading companies SINCE 2001.



1979 Sunpass's holding company, Tenglong, established by Mr. Xu, mainly manufactures sealing gaskets and insulation material.



2001 Sunpass, established by Ms. Xu, specializes in the design and manufacture of ISO tank container spare parts to extends Tenglong's business. The quality is controlled by ISO9001:2008



Sunpass shift to the new 6000m² factory.



for petrochemical, metallurgy, chemicals industries



Sunpass is equipped with advanced germany technology and equipment.



Sunpass extends its world coverage and product lines

1979

2001

2002

2014

2014 **ITCO**
Sunpass joins ITCO;
Sunpass authorizes 1st overseas agent.

2015



**SUNPASS Customers are all over the world.
Welcome more SUNPASS agents to join SUNPASS !**

- Manlid Spare Parts
- 6-9 Seal
- 10 Clamp
- Valve Spare Parts
- 12-16 Flange Gasket
- 17 100% Virgin PTFE Seal for Valve
- 18 O Ring
- 19 Other Seals
- 20-21 Dust Cap
- 23 Flange
- 24 Flame Gauze
- 25 One way Ball Valve
- Other Spare Parts
- 27-28 Manometer and Thermometer
- 29 Document Holder
- 30 Date Plate
- 31 Walkway
- 32 Tir Pin
- 33 Rivet
- Spare Parts for Dry Container

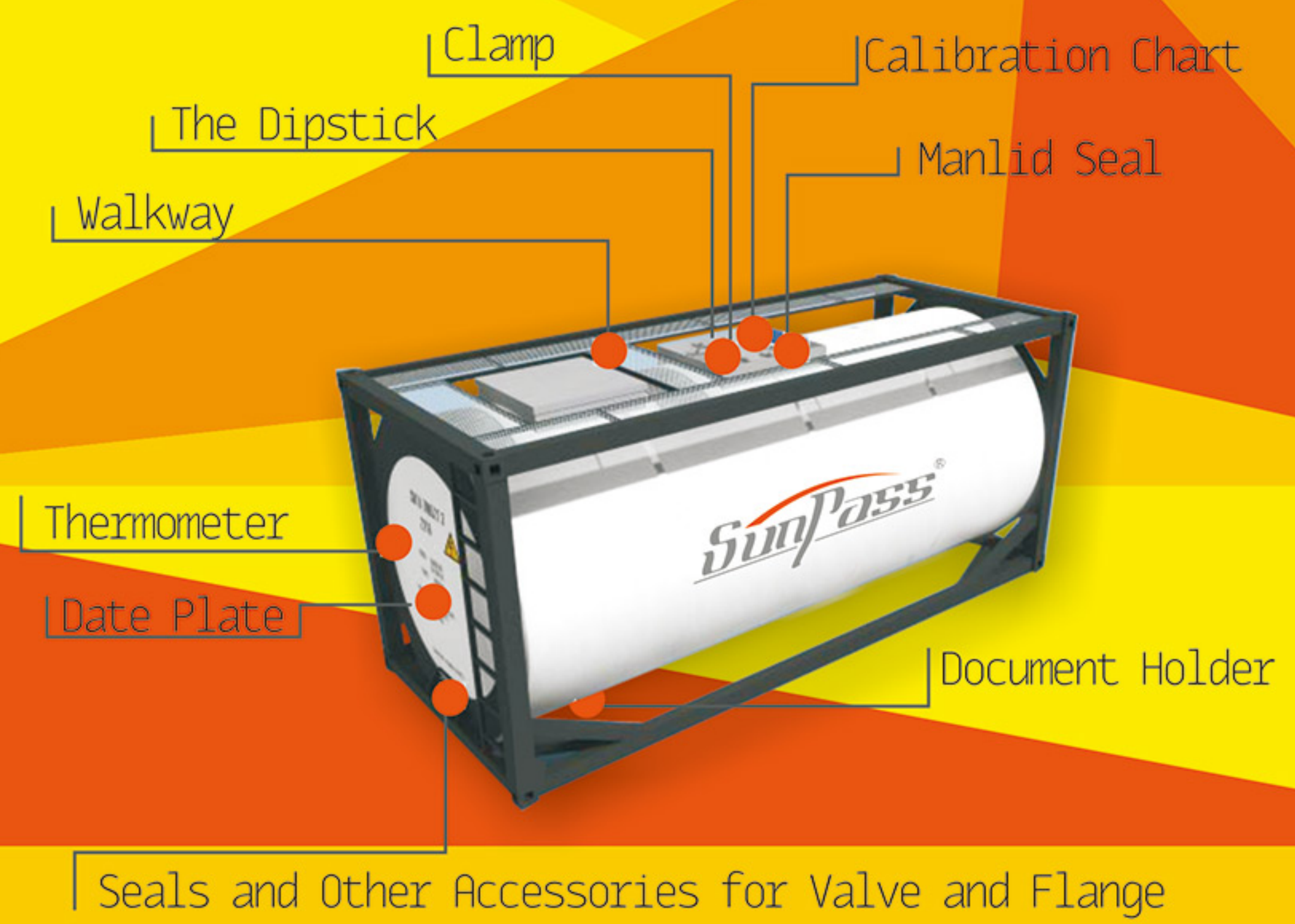

ONE STOP FOR ALL TANK SPARE PARTS SOLUTIONS

Manlid Spare Parts



SUPER TANK SEAL

Description

This manlid seal combines the resilience and compression set resistance of EPDM rubber with the outstanding chemical resistance of PTFE.

The seal's rectangular elastomeric core is enveloped on three sides: top and bottom sealing faces and the inside diameter with 100% virgin PTFE.

Advantages

Excellent chemical resistance.
Withstands repeated opening/closing cycles without loss of sealing integrity.

Chemical properties

The PTFE envelope makes the sealing faces and inside diameter chemically inert to media in the range pH 0-14 including all bulk liquid cargoes in all IMO classes.

The virgin PTFE is non-absorbent, non-tainting, and hygienic for use with foodstuffs and edible oils.

Service capabilities

Tank maximum pressure: 4bar Maximum temperature: +110°C Minimum temperature: -25°C

Ordering and coding information:

SUNPASS CODE	TYPE	SIZE
EP00001	DN500	(14MM *12MM) SECTION*486MM INNER DIA.
EP00002	DN500	(14MM *14MM) SECTION*490MM INNER DIA.
EP00003	DN300	(14MM *10MM) SECTION*294MM INNER DIA.

Many dimensions are available as well as special seals to suit specific manlids

PTFE BRAIDED SEAL

Description

Clean length form braided packing for lids and fittings on static and mobile tank containers.

Sunpass PTFE Braided Seal is manufactured from an inert reinforced special fiber yarn, impregnated with PTFE and an inert resin to provide a non-stick surface. Other fiber material is available

Ordering and coding information:

Sunpass Code	Size
AP00001	14MM X 14MM SECTION X 1625MM LENGTH
AP00002	14MM X 14MM SECTION X 1630MM LENGTH
AP00003	14MM X 14MM SECTION X 1650MM LENGTH
AP00004	10MM X 14MM SECTION X 1625MM LENGTH
AP00005	10MM X 14MM SECTION X 1630MM LENGTH
AP00006	10MM X 14MM SECTION X 1650MM LENGTH
AP00007	10MM X 15MM SECTION X 1650MM LENGTH
AP00008	10MM X 10MM SECTION X 1650MM LENGTH
AP00009	14MM X 12MM SECTION X 1650MM LENGTH
AP00010	10MM X 15MM SECTION X 50METERS LENGTH
AP00011	14MM X 14MM SECTION X 50METERS LENGTH
AP00012	14MM X 14MM SECTION X 50METERS LENGTH

Many dimensions and materials are available as well as special seals to suit specific manlids

Sunpass PTFE Braided Seal With Silicon Core is designed for use on tanks that handle aggressive cargoes under an inert gas blanket. Its elasticity is improved by silicon core

Advantages:

- Easy to cut and fit in small lid recesses.
- Excellent sealing capability on repeated opening/closing cycles.
- Controls emission levels from tanks.
- Protects tank contents from external contamination.
- Withstands arduous cleaning systems.
- Part of the comprehensive range of tank lid sealing products.

Other Material Code:

Code + S: With Silicone Core:
Code + P: Pure PTFE Material
Code + G: Graphite-PTFE Material
(E.g., AP00001 is for without silicon core manlid seal; AP00001S is for with resilient core manlid seal; AP00001P is for pure PTFE material manlid seal; AP0000G is for graphite-PTFE material)

Chemical properties

Inert to media in the range pH 0-14 (except for HF and certain fluorine containing compounds) and totally compatible with a full range of cargoes including chemicals, petroleum products and foodstuffs.

Service capabilities

Tank maximum pressure: 2bar Maximum temperature: +120°C Minimum temperature: -50°C

FEP/PFA ENCAPSULATED SEAL

Description

FEP ENCAPSULATED SEAL is consisted of a seamless and uniform Teflon® FEP encapsulation which completely encloses a core material of either silicone or Viton® elastomers. The combination of these components creates a seal that is virtually chemically inert and compression set resistant for use in harsh sealing environments.

Advantage

- High Chemical Resistance
- Outperforms solid PTFE O-Rings
- Wide Temperature Range
- Non Stick Surface
- Low Coefficient of Friction
- Sanitary
- Unlimited Sizes
- Low Compression Set

Encapsulated Seal VS Solid PTFE

A standard elastomeric seal has inadequate chemical resistance for a specific application, and A solid PTFE seal does not offer sufficient elasticity for reliable, long-term fluid sealing.

These are held in a variety of general and high performance elastomers to suit the vast majority of industrial and specialised oil & gas sector applications.

Service capabilities

Continuous Service temperature: -60°C to +200°C

Many dimensions are available as well as special seals to suit different applications

Ordering and coding information:

SUNPASS CODE	TYPE	SIZE
FO00009	DN500	(DIA. 16MM) SECTION*486MM INNER DIA.
FO00010	DN500	(14MM *14MM) SECTION*486MM INNER DIA.
FO00011	DN300	(14MM *10MM) SECTION*294MM INNER DIA.

Many dimensions are available as well as special seals to suit specific manlids

RUBBER SEAL (EPDM/SWR/VITON/NITRILE/SILICON)

The following seals are used in manlid. Other materials and sizes not listed below can be customized.

Ordering and code information:

SUNPASS CODE	MATERIAL	APPLICATION	SIZE
EP00004	Sweet White Rubber	Food Grade; Temperature Resistance: -50°C to 80°C	(16MM * 10MM) SECTION * 486MM INNER DIA
EP00005	EPDM	Certain corrosive cargoes, not suitable for liquefied, or petrolic products; Temperature Resistance: -50°C to 150°C	(14MM*14MM) SECTION * 490MM INNER DIA
EP00006	EPDM	Certain corrosive cargoes, not suitable for liquefied, or petrolic products; Temperature Resistance: -50°C to 150°C	(15.24MM*11.8MM) SECTION * 463.30MM INNER DIA
V00001	Viton	Non-corrosive cargoes; Temperature resistance: -15°C to 200°C	(14MM * 14MM)SECTION * 490 INNER DIA
V00002	Viton	Non-corrosive cargoes; Temperature resistance: -15°C to 200°C	(14MM * 10MM)SECTION * 490 INNER DIA
SWR00001	Sweet White Rubber	Food Grade; Temperature Resistance: -50°C to 80°C	(14MM * 10MM)SECTION * 1650MM LENGTH

Description

A manlid clamp fitted to the manlid as a safety precaution opening when the tank is under pressure. Good anity-corrosion ability. Swing bolts facilitate easier maintenance and packing replacement.

MANLID CLAMP

Eye bolt with 16mm or 3/4" eye (Dimension A) X 3/4" BSW (Dimension B) X length from center of eye to end of bolt (Dimension C). Manufactured in Stainless Steel. Fitted with M8 grubs crew. Supplied with swing bolt hinge pin and captivated wing nut.

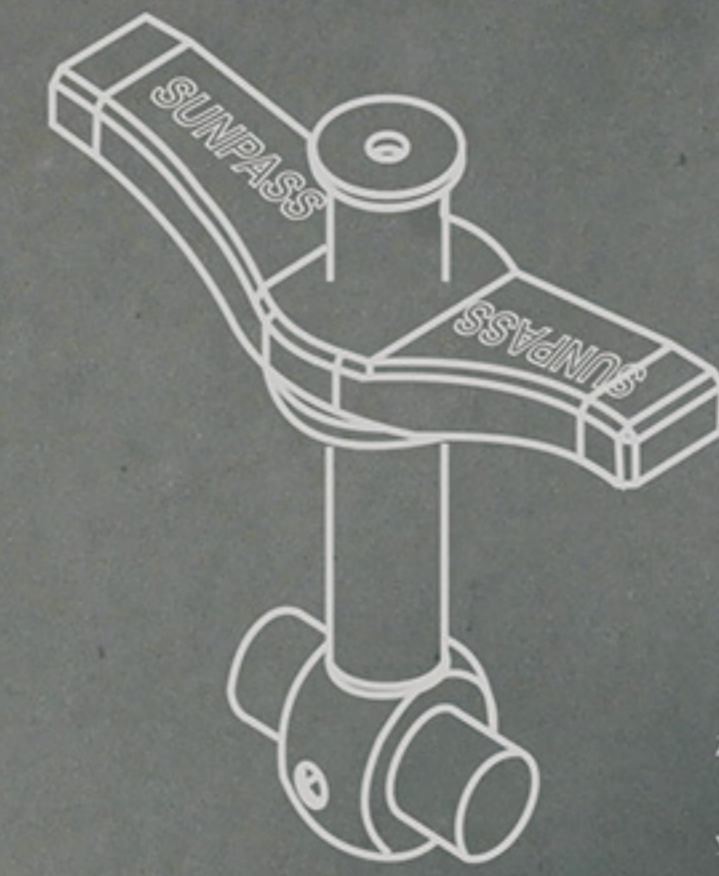

Ordering and code information:

LENGTH	WING NUT	MATERIAL	HINGE PIN	SUNPASS CODE
91MM	3/4"	Brass, Stainless steel	Φ 16MM * 45MM	SB00001
			Φ 3/4" * 45MM	SB00002
95MM			Φ 16MM * 45MM	SB00003
			Φ 3/4" * 45MM	SB00004
61MM			Φ 16MM * 45MM	SB00005
			Φ 3/4" * 45MM	SB00006

Swing Bolt Assemblies:

Description	SUNPASS CODE
1/2" eyebolt * 61MM	SB00007A
1/2" eyebolt * 91MM	SB00008A
1/2" eyebolt * 95MM	SB00009A
Φ 16MM * 61MM	Sb00007B
Φ 16MM * 91MM	Sb00008B
Φ 16MM * 95MM	SB00009B
Wing nut	SB00010
Hinge Pin	SB00011
M8 grub screw	SB00012

Valve Spare Parts



FLANGE GASKET

Description

SUNPASS CNAF/PTFE gaskets for tank container applications combine the chemical inertness and hygienic qualities of 100% virgin PTFE with the mechanical properties of the compressed asbestos free CNAF gasket.

Advantages

These gaskets are designed for flanged joints handling, to be placed in between two flanges and ensure leak tightness.

Aggressive fluid media that would swiftly destroy the integrity of other material and for duties with foodstuffs where cleanliness and non-contamination are essential

Service capabilities

Tank working pressure: 4.4bar
Esaily meets tank test pressure: 6.0bar
Maximum temperature: 250°C



FLANGE GASKET



SUNPASS Code	Thickness	No. of Holes	A HoleΦ	B PCD	C InternalΦ
EV00001	3MM	6	18MM	166MM	81MM
D ExternalΦ	Application		Remarks		
197MM	SYPHONE TUBE GASKET 6 HOLE		SP702500		

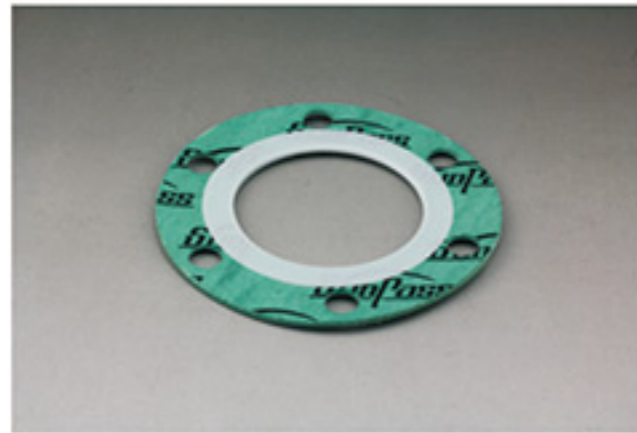

SUNPASS Code	Thickness	No. of Holes	A HoleΦ	B PCD	C InternalΦ
EU00002	2.5MM	6	12MM	107MM	69.5MM
D ExternalΦ	Application		Remarks		
127.5MM	PV VALVE ENVELOPE 6 HOLE GASKET U-TYPE		SP702502U		

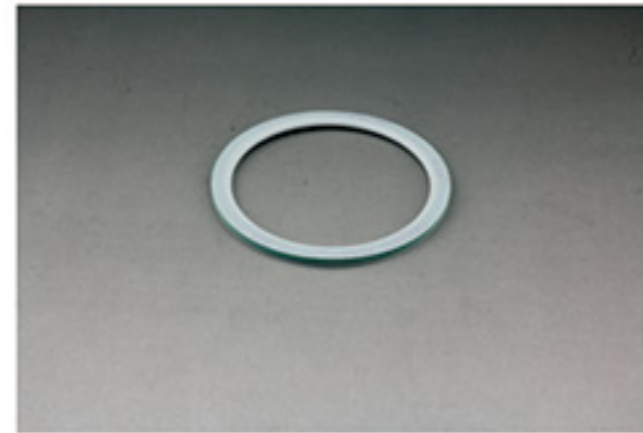

SUNPASS Code	Thickness	No. of Holes	A HoleΦ	B PCD	C InternalΦ
EU00004	2.5MM	-	-	-	75.5MM
D ExternalΦ	Application		Remarks		
90.0MM	2 1/2" BSP PV VALVE SEAL		SP702504 + 1291310000		

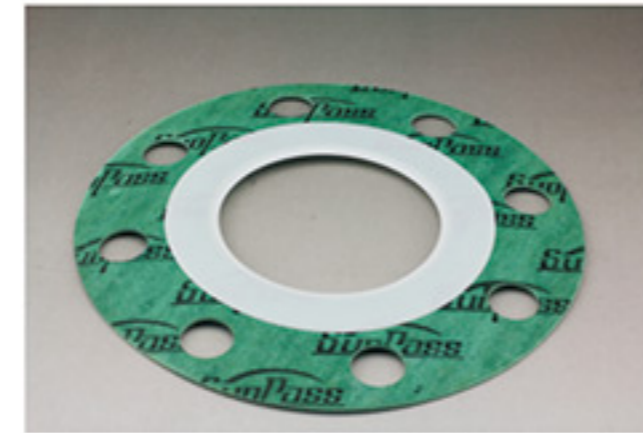

SUNPASS Code	Thickness	No. of Holes	A HoleΦ	B PCD	C InternalΦ
EV00005	3MM	8	18MM	150MM	80MM
D ExternalΦ	Application		Remarks		
159MM	PV VALVE FLANGE GASKET 8 HOLE		SP702505		

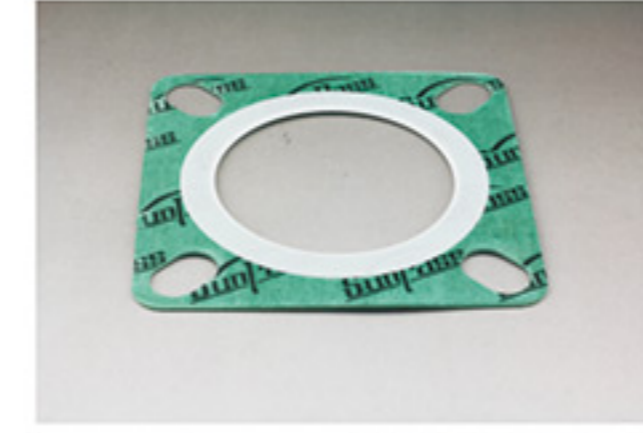

SUNPASS Code	Thickness	No. of Holes	A HoleΦ	B PCD	C InternalΦ
EU00017	2.5MM	-	-	145-162	90MM
D ExternalΦ	Application		Remarks		
144MM	3" OUTLET NOZZLE SQUARE		SP1291420000		



SUNPASS Code	Thickness	No. of Holes	A HoleΦ	B PCD	C InternalΦ
EU00027	2.5MM	6	11MM	109MM	79MM
D ExternalΦ	Application		Remarks		
128MM	2 1/2" FLANGED RELIEF VALVE TANK PAD		SP9005-396		

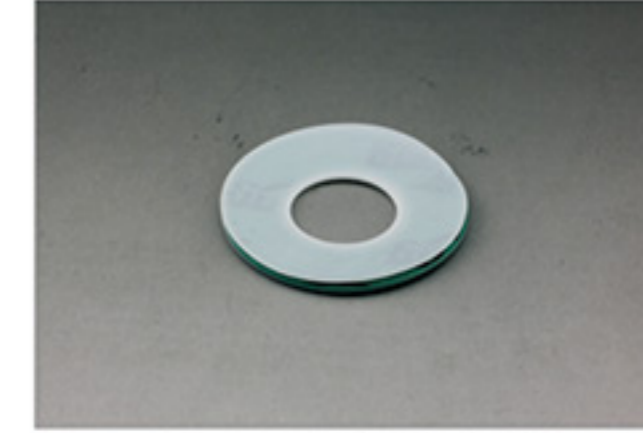

SUNPASS Code	Thickness	No. of Holes	A HoleΦ	B PCD	C InternalΦ
EU00030	2.5MM	-	-	-	79MM
D ExternalΦ	Application		Remarks		
112MM	3" CLAMPED BUTTERFLY VALVE INLET		SP9005-049		



SUNPASS Code	Thickness	No. of Holes	A HoleΦ	B PCD	C InternalΦ
EU00031	2.5MM	4	18MM	100MM	81MM
D ExternalΦ	Application		Remarks		
144MM	TO BE REPLACED BETWEEN VALVE AND FOOTVALE		SP1291300000		

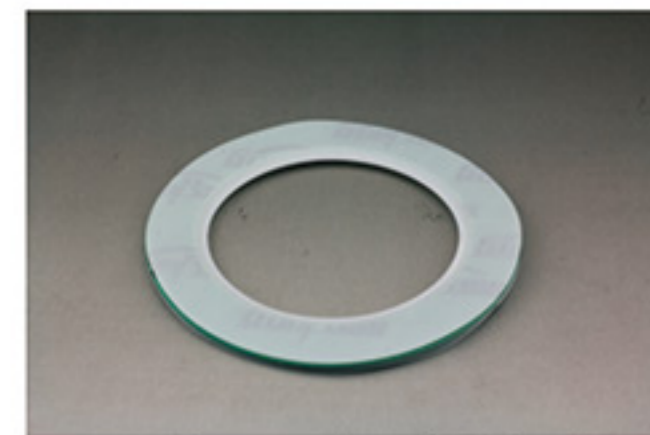

SUNPASS Code	Thickness	No. of Holes	A HoleΦ	B PCD	C InternalΦ
EV00006	3MM	-	-	-	90MM
D ExternalΦ	Application		Remarks		
139MM	BUTTERFLY V/V GASKET(WITHOUT HOLE)		SP702108		

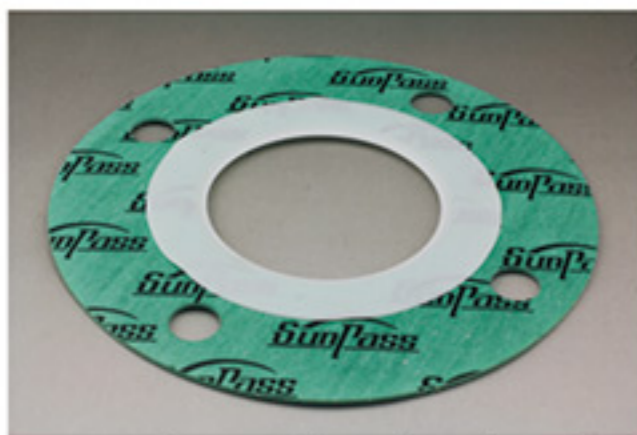

SUNPASS Code	Thickness	No. of Holes	A HoleΦ	B PCD	C InternalΦ
EV00007	3MM	4	18MM	100MM	60MM
D ExternalΦ	Application		Remarks		
203MM	BUTTERFLY VALVE 3" GASKET 4 HOLE		SP702110		

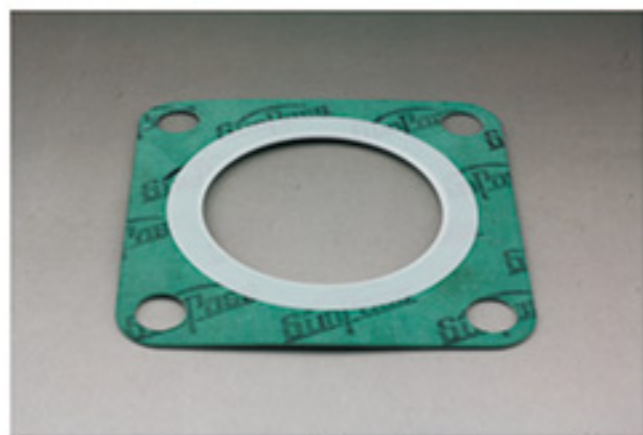

SUNPASS Code	Thickness	No. of Holes	A HoleΦ	B PCD	C InternalΦ
EU00008	2.5MM	4	18MM	100MM	89.5MM
D ExternalΦ	Application		Remarks		
148MM	3" BUTTERFLY VALVE 4 HOLE SQUARE GASKET		SP702105A		



SUNPASS Code	Thickness	No. of Holes	A HoleΦ	B PCD	C InternalΦ
EV00009	3MM	8	18/14MM	170MM	115.5MM
D ExternalΦ	Application		Remarks		
209MM	4 1/2" FOOTVALVE GASKET HOLE		SP702118		



SUNPASS Code	Thickness	No. of Holes	A HoleΦ	B PCD	C InternalΦ
EU00032	2.5MM	4	19MM	101.4MM	45MM
D ExternalΦ	Application		Remarks		
150MM	7" ATCO BALL VALVE ATCO NOZZLE FLANGED BALL VALVE		SP1291000000		

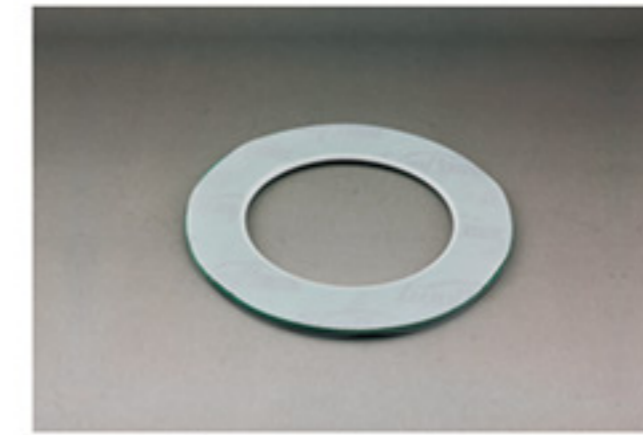

SUNPASS Code	Thickness	No. of Holes	A HoleΦ	B PCD	C InternalΦ
EU00033	2.5MM	-	-	-	78MM
D ExternalΦ	Application		Remarks		
110MM	Dn60 CHEMPLY LIGHT BOTTOM DISCHARGE		SP1712211000		



SUNPASS Code	Thickness	No. of Holes	A HoleΦ	B PCD	C InternalΦ
EU00034	2.5MM	4	18MM	125MM	50MM
D ExternalΦ	Application		Remarks		
165MM	7" ATCO BALL VALVE AND TWPV BUTTERFLY VALVE INLET		SP9005-305A SP119200000		

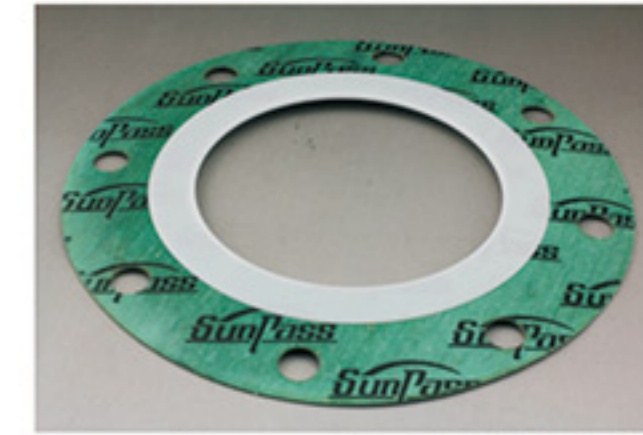

SUNPASS Code	Thickness	No. of Holes	A HoleΦ	B PCD	C InternalΦ
EU00036	2.5MM	4	14MM	194.2MM	114MM
D ExternalΦ	Application		Remarks		
213MM	4" CHEMFLOW BOTTOM DISCHARGE		SP1711039002		



SUNPASS Code	Thickness	No. of Holes	A HoleΦ	B PCD	C InternalΦ
EV00010	3MM	4	10MM	103MM	38MM
D ExternalΦ	Application		Remarks		
130MM	1" AIRLINE ENVELOPE GASKET		SP702103 ENY		



SUNPASS Code	Thickness	No. of Holes	A HoleΦ	B PCD	C InternalΦ
EV00011	3MM	4	10MM	99MM	45MM
D ExternalΦ	Application		Remarks		
130MM	1" AIRLINE BLIND FLANGE ENV. GASKET		SP702104		



SUNPASS Code	Thickness	No. of Holes	A HoleΦ	B PCD	C InternalΦ
EV00012	3MM	4	18MM	129MM	50MM
D ExternalΦ	Application		Remarks		
169MM	2" FLANGE AIRLINE BFLY INLET GASKET		SP702105		



SUNPASS Code	Thickness	No. of Holes	A HoleΦ	B PCD	C InternalΦ
EU00013	2.5MM	-	-	-	90MM
D ExternalΦ	Application		Remarks		
140MM	3" CLAMPED BUTTERFLY VALVE OUTLET		SP5005-490		



SUNPASS Code	Thickness	No. of Holes	A HoleΦ	B PCD	C InternalΦ
EU00037	2.5MM	4	18MM	100MM	100MM
D ExternalΦ	Application		Remarks		
169MM	7" BUTTERFLY VALVE 4-HOLE VALVES INLET AND OUTLET FLANGES		SP119098000		



SUNPASS Code	Thickness	No. of Holes	A HoleΦ	B PCD	C InternalΦ
EU00038	2.5MM	4	18MM	149MM	92MM
D ExternalΦ	Application		Remarks		
178MM	Dn60 MEGA SUPERVENTIX SAFETY RELIEF VALVE		SP1292040000		



SUNPASS Code	Thickness	No. of Holes	A HoleΦ	B PCD	C InternalΦ
EU00042	2.5MM	8	14MM	170MM	114MM
D ExternalΦ	Application		Remarks		
200MM	FOR 30" 345" 3070 DISCHARGE FLARE AND HES FLARE		SP1291200000		



SUNPASS Code	Thickness	No. of Holes	A HoleΦ	B PCD	C InternalΦ
EU00044	4MM	-	-	-	79MM
D ExternalΦ	Application		Remarks		
90MM	JOINT SOUFAPE SUPERVENTIX(S)		SP5005-066A1291960000		

FLANGE GASKET



SUNPASS Code	Thickness	No. of Holes	A	B	C
EU00049	2.5MM	8	140MM	178MM	114MM
D	Application		Remarks		
203MM	45°90° CLEANFLOW HIGH LIFT FOOT VALVE INLET		SP5005-195SP1291310000		



SUNPASS Code	Thickness	No. of Holes	A	B	C
EU00051	2.5MM	4	185MM	150MM	85MM
D	Application		Remarks		
144MM	3" CLAMPED BUTTERFLY VALVE OUTLET(SQUARE)		SP5005-195		



SUNPASS Code	Thickness	No. of Holes	A	B	C
EU00052	2.5MM	6	140MM	168MM	101.5MM
D	Application		Remarks		
203.2MM	3" TOP DISCHARGE BUTTERFLY		SP5005-222		



SUNPASS Code	Thickness	No. of Holes	A	B	C
EU00053	2.5MM	4	158MM	178MM	114.3MM
D	Application		Remarks		
218MM	30" FOOT VALVE INLET		SP5005-032		



SUNPASS Code	Thickness	No. of Holes	A	B	C
EU00054	2.5MM	6	13.5MM	168.4MM	77.7MM
D	Application		Remarks		
197MM	3" FLANGED BUTTERFLY'S BALL VALVE INLET		SP5005-169		



SUNPASS Code	Thickness	No. of Holes	A	B	C
EU00055	2.5MM	4	19MM	149MM	82MM
D	Application		Remarks		
190MM	FLANGED BUTTERFLY BALL VALVE OUTLET'S GASKET SIDE		SP5005-427		

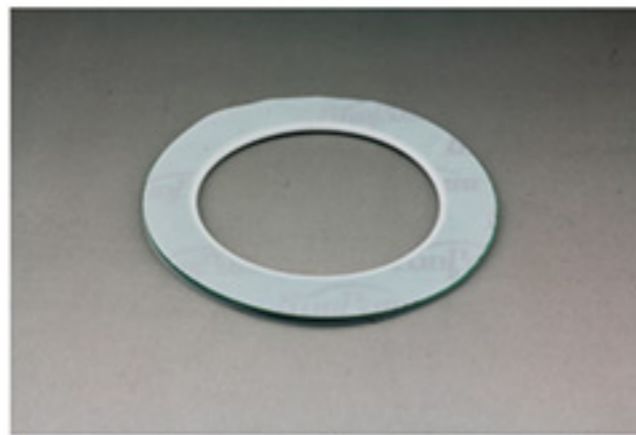

SUNPASS Code	Thickness	No. of Holes	A	B	C
EU00056	2.5MM	-	-	-	90MM
D	Application		Remarks		
127MM	TO BE PLACED BETWEEN VALVE AND OUTLET NOZZLE		SP1712100001		

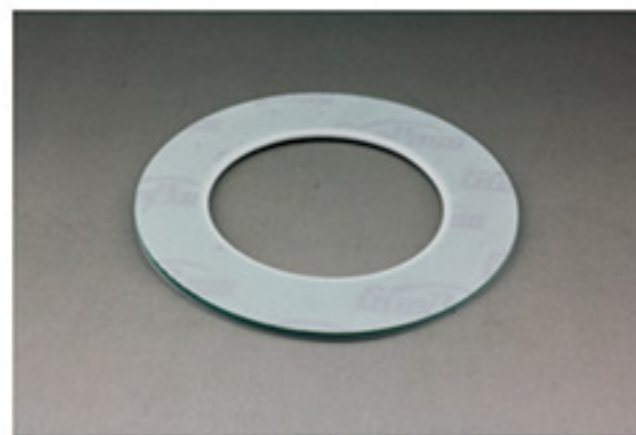

SUNPASS Code	Thickness	No. of Holes	A	B	C	D
EU00014	2.5MM	-	-	-	80MM	140MM

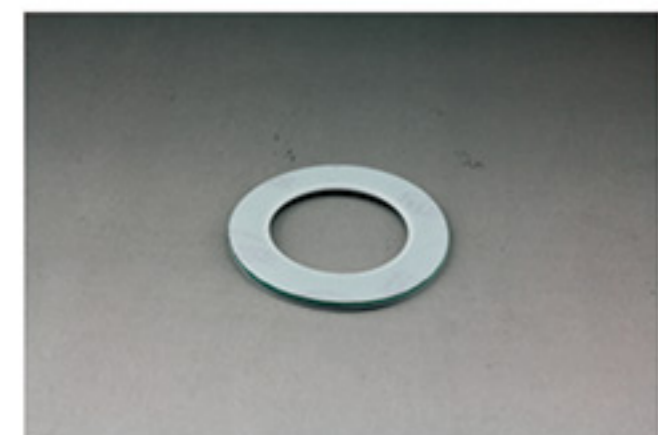

SUNPASS Code	Thickness	No. of Holes	A	B	C	D
EU00015	2.5MM	-	-	-	50MM	80MM

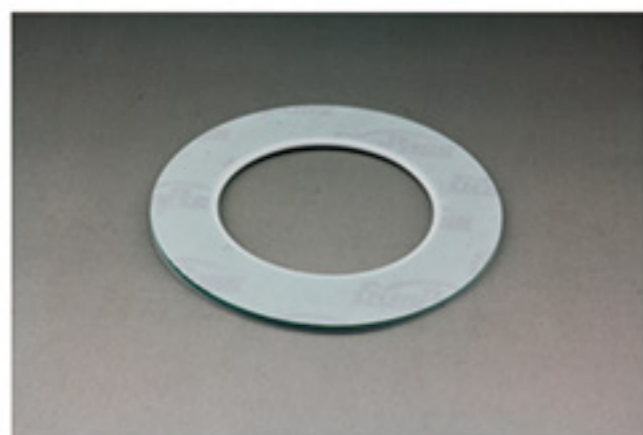

SUNPASS Code	Thickness	No. of Holes	A	B	C	D
EU00016	2.5MM	-	-	-	80MM	130MM

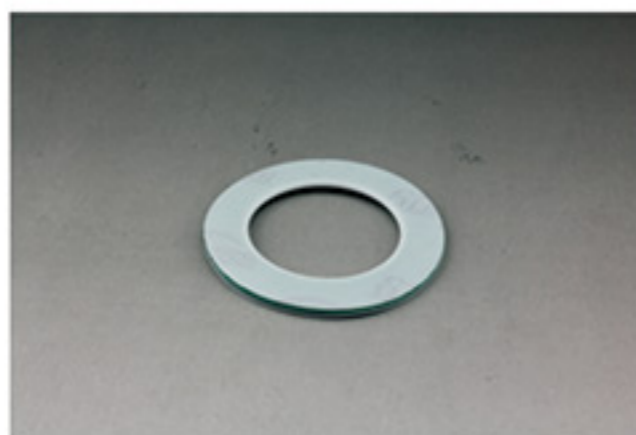

SUNPASS Code	Thickness	No. of Holes	A	B	C	D
EU00018	2.5MM	-	-	-	50MM	90MM

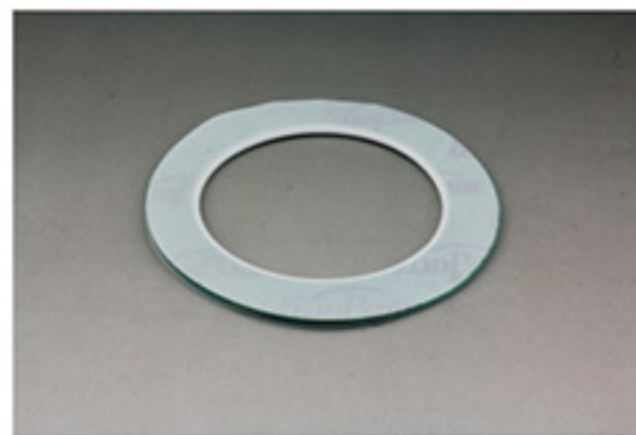

SUNPASS Code	Thickness	No. of Holes	A	B	C	D
EU00019	2.5MM	-	-	-	90MM	130MM

OTHER FLANGE GASKETS

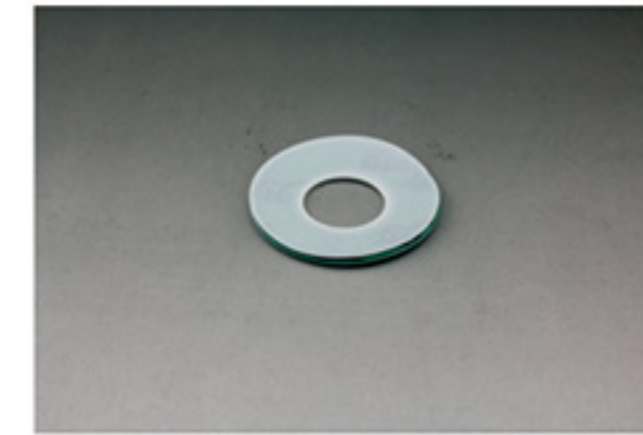

SUNPASS Code	Thickness	No. of Holes	A	B	C	D
EU00020	2.5MM	-	-	30MM	70MM	-

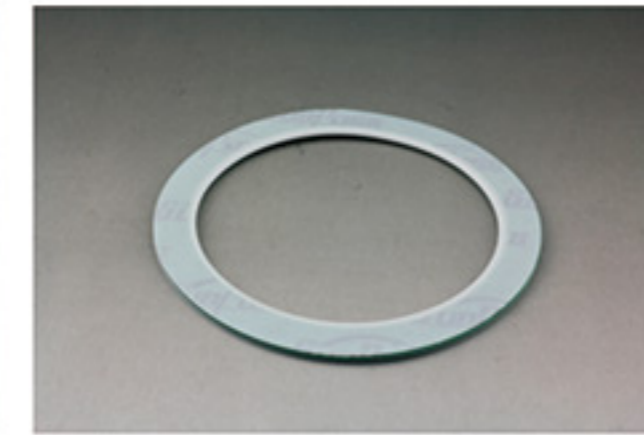

SUNPASS Code	Thickness	No. of Holes	A	B	C	D
EU00021	2.5MM	-	-	110MM	140MM	-

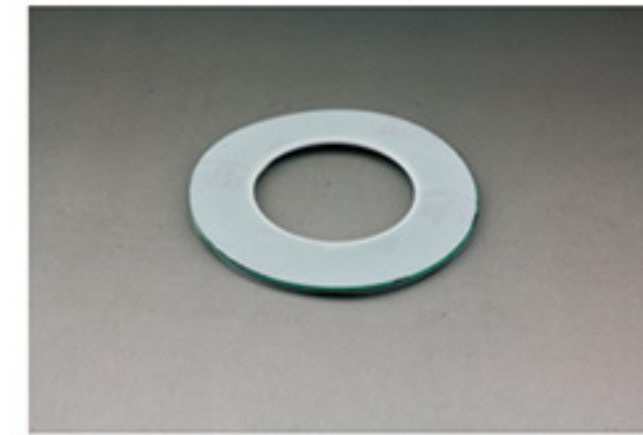

SUNPASS Code	Thickness	No. of Holes	A	B	C	D
EU00022	2.5MM	-	-	60MM	106.5MM	-



SUNPASS Code	Thickness	No. of Holes	A	B	C	D
EU00023	2.5MM	4	18MM	160MM	115MM	215MM



SUNPASS Code	Thickness	No. of Holes	A	B	C	D
EU00024	2.5MM	6	14MM	170MM	80MM	200MM



SUNPASS Code	Thickness	No. of Holes	A	B	C	D
EU00025	2.5MM	8	14MM	178MM	114MM	205MM

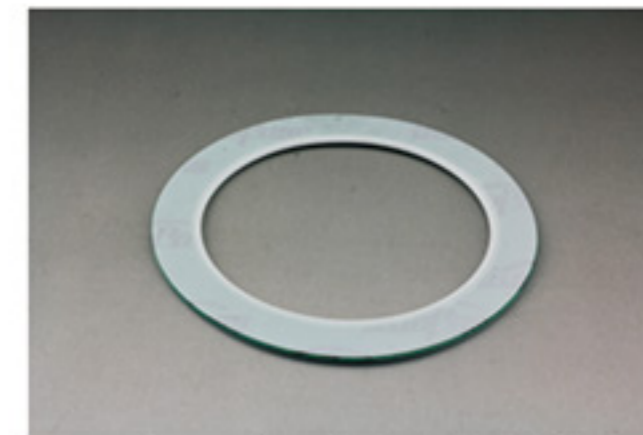

SUNPASS Code	Thickness	No. of Holes	A	B	C	D
EU00026	2.5MM	-	-	105MM	140MM	-

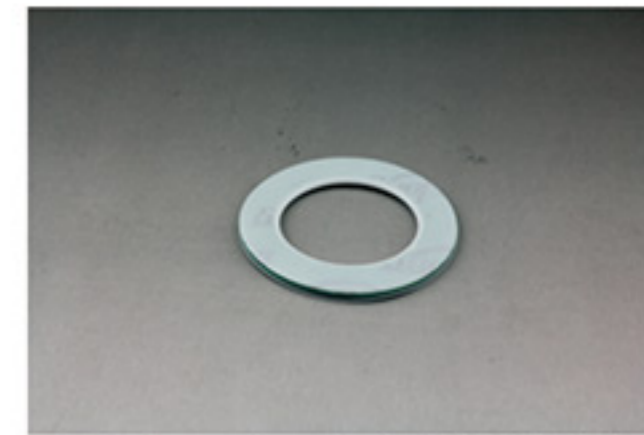

SUNPASS Code	Thickness	No. of Holes	A	B	C	D
EU00028	2.5MM	-	-	50MM	80MM	-

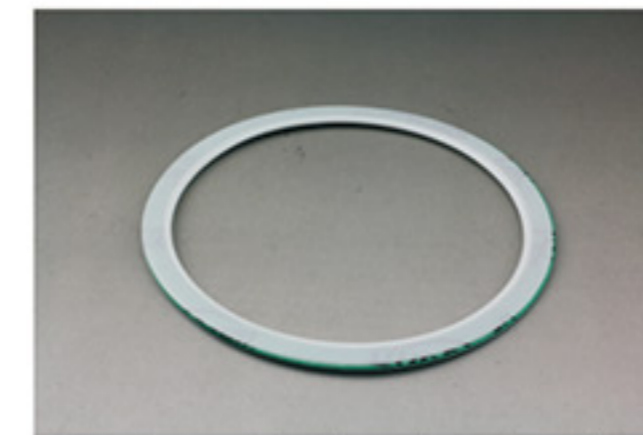

SUNPASS Code	Thickness	No. of Holes	A	B	C	D
EU00029	2.5MM	-	-	120MM	150MM	-



SUNPASS Code	Thickness	No. of Holes	A	B	C	D
EU00035	2.5MM	4	12MM	150MM	109MM	174MM



SUNPASS Code	Thickness	No. of Holes	A	B	C	D
EU00039	2.5MM	4	18MM	161.5MM	90MM	144MM



SUNPASS Code	Thickness	No. of Holes	A	B	C	D
EU00040	2.5MM	4	18MM	170MM	109MM	154MM

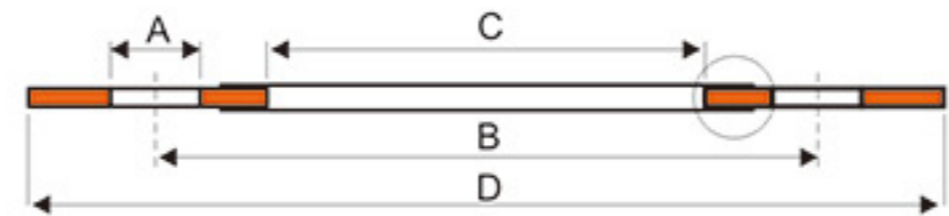

CNAF gasket
PTFE envelope

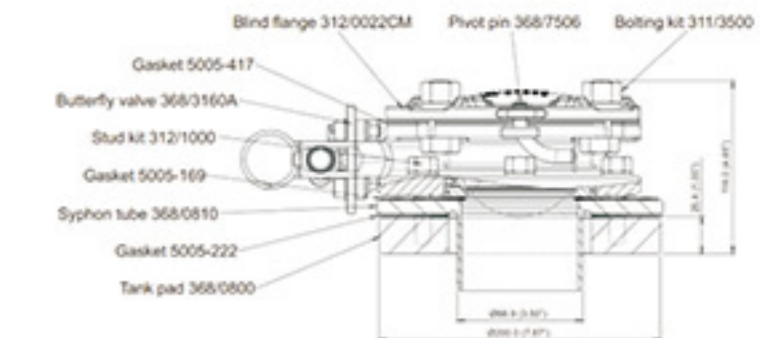

100% VIRGIN PTFE SEAL FOR VALVE



SUNPASS Code	Description
PG00001	Rear Seal For 1" Fort Vale BSP Airline Ball Valve SP5005-007



SUNPASS Code	Description
PG00002	Front Seal For 1" Fort Vale BSP Airline Ball Valve SP5005-006

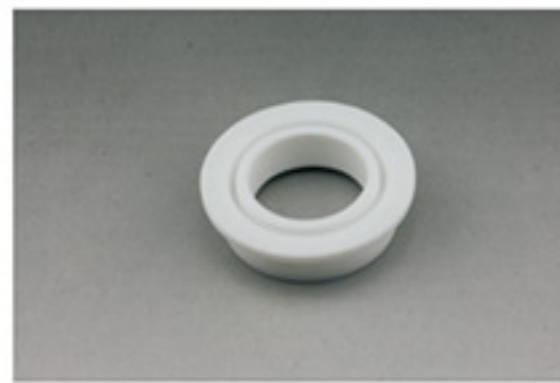

SUNPASS Code	Description
PG00003	Rear Seal For 1" Perolo BSP Airline Ball Valve SP1191090000

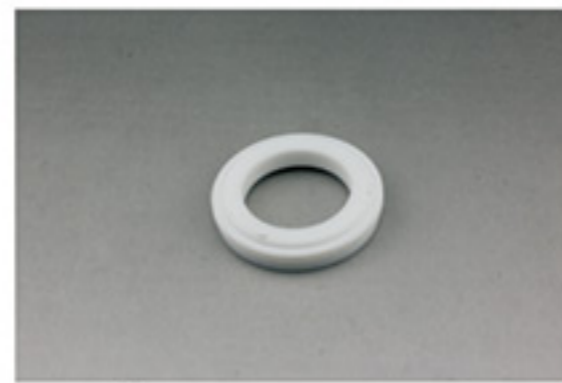

SUNPASS Code	Description
PG00004	Front Seal For 1" Perolo Blacko Airline Ball Valve SP1191090000



SUNPASS Code	Description
PG00005	Butterfly valve 3" main seal Fits and seals both Fort Vale and Perolo applications



SUNPASS Code	Description
PG00006	Butterfly valve 3" main seal Only for Perolo applications



SUNPASS Code	Description
PG00007	2" Main Seal For 2" Flanged Airline Butterfly Valve SP 355/0202



SUNPASS Code	Description
PG00008	1" BSP Airline Ball Valve Square Seal



SUNPASS Code	Description
PG00009	2" BSP Airline Ball Valve Square Seal



SUNPASS Code	Description
PG00015	PV Valve Combination Teflon Seal

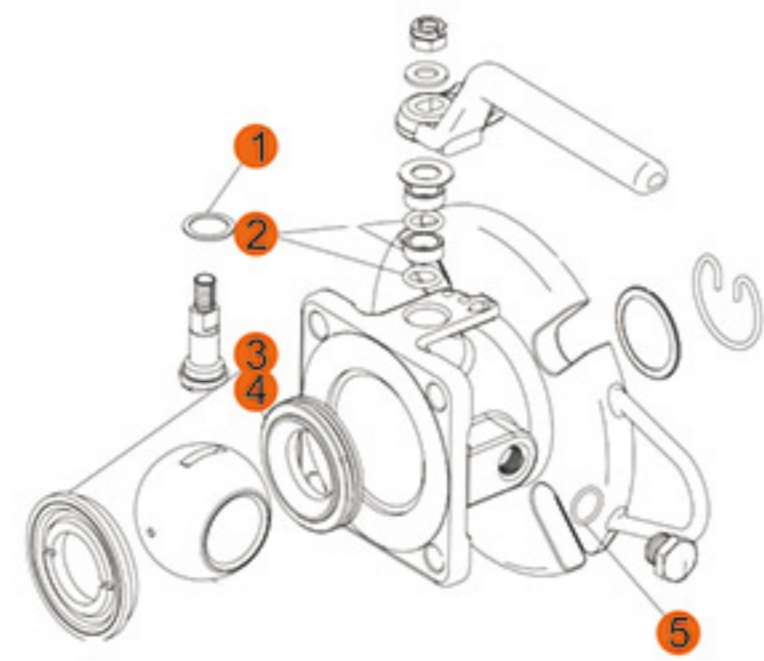

All these gaskets are made from the highest quality PTFE compounds supplied by world leading manufacturers. They are precision manufactured components designed specifically to give long life with high integrity sealing.



Ordering and code information:

SUNPASS CODE	MATERIAL	APPLICATION	SIZE
V00003	Viton	O' Ring	SP20361
FO00002	FEP/SIL.	3" Footvalve	ID: Φ78.74MMX Section Φ5.33MM BS338
FO00004	FEP Incapsulated O Ring	2.5" PRV /safety relief valve	ID: Φ65.50MMX Section Φ5.7MM
FO00005	FEP/SIL.	PV Valve Vacuum O' Ring	ID: Φ31.34MMX Section Φ3.55MM
FO00006	FEP Viton	Encapsulated O Ring	ID: Φ50.39MMX Section Φ3.53MM
FO00007	FEP/SIL.	Manlid Seal DN500	ID486Xsection16MM(round)
FO00008	FEP/SIL.	Foot Valve O-Ring	ID: Φ69.22MMX Section Φ5.33MM BS335
FO00009	FEP Encapsulated Silicon	3" Footvalve	FEP/SIL. 75.57X5.33MM BS337 /MHF

O RING

Sunpass FEP-encapsulated 'O' rings have a resilient core of silicone (VMQ) elastomer completely covered with a bleedline-free sheath of FEP fluoropolymer.

They are fully interchangeable with standard elastomeric 'O' rings and solid PTFE 'O' rings

Advantages:

- Excellent chemical resistance to a wide range of fluid media.
- High level of hygiene for use with foodstuffs and edible oils.
- Far better elasticity and seal ability than solid PTFE rings.
- Operational temperature range of -60°C to +200°C.

Other 'O' ring material and size are available on request



Description:
SUNPASS PTFE seals serve as the connections and sealing parts for various valves and other equipments to avoid leakage, rubber, PTFE or other material is available.

OTHER SEAL

Other size are available on request.



STAINLESS STEEL DUST CAP



Ordering and code information:

DESCRIPTION	SUNPASS CODE
1/4" BSP stainless steel cap with chain & PTFE gasket	DC00005
1" BSP stainless steel cap with chain & PTFE gasket	DC00004
1 1/2" BSP stainless steel cap with chain & PTFE gasket	DC00003
2" BSP stainless steel cap with chain & PTFE gasket	DC00002
3" BSP stainless steel cap with chain & PTFE gasket	DC00001

Other sizes and materials available on request.

ALUMINIUM DUST CAP



Ordering and code information:

DESCRIPTION	SUNPASS CODE
½" BSP aluminium cap with chain & PTFE gasket	DC00012
¾" BSP aluminium cap with chain & PTFE gasket	DC00011
1" BSP aluminium cap with chain & PTFE gasket	DC00010
1½" BSP aluminium cap with chain & PTFE gasket	DC00008
2" BSP aluminium cap with chain & PTFE gasket	DC00007
2½" BSP aluminium cap with chain & PTFE gasket	DC00013
3" BSP aluminium cap with chain & PTFE gasket	DC00006

Other sizes and materials available on request.

PTFE FLAT DUST CAP GASKET

Ordering and code information:

DESCRIPTION	SUNPASS CODE
½" gasket	PG00015
¾" gasket	PG00013
1" gasket	PG00014
1½" gasket	PG00012
2" gasket	PG00011
3" gasket	PG00010

Other sizes available on request.

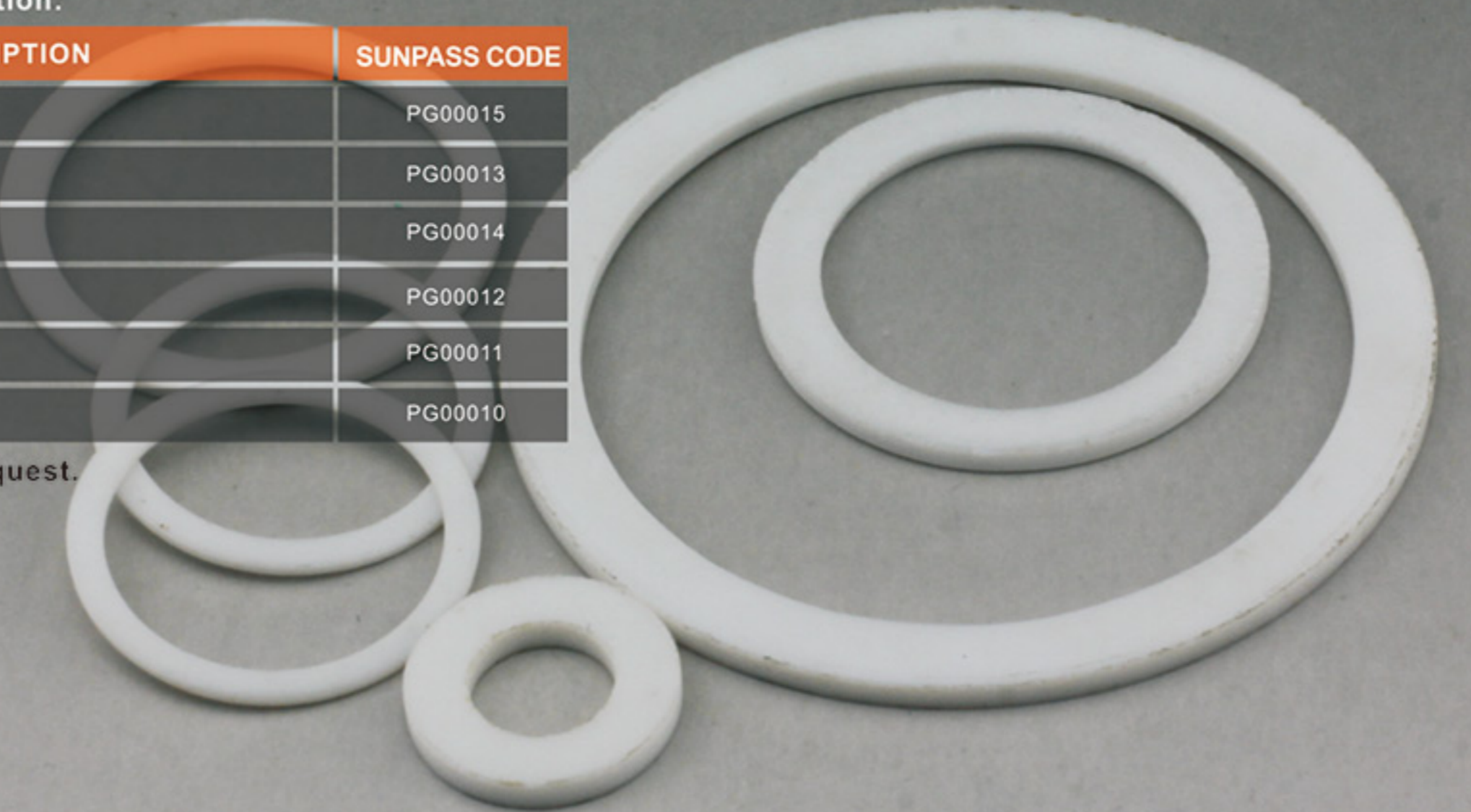

DUST CAP CHAIN

Ordering and code information:

DESCRIPTION	SUNPASS CODE
Chain for ½" dust cap	DC/SC00001
Chain for ¾" dust cap	DC/SC00002
Chain for 1" dust cap	DC/SC00003
Chain for 1½" dust cap	DC/SC00004
Chain for 2" dust cap	DC/ALU00001
Chain for 3" dust cap	DC/ALU00002

Other sizes and materials available on request.

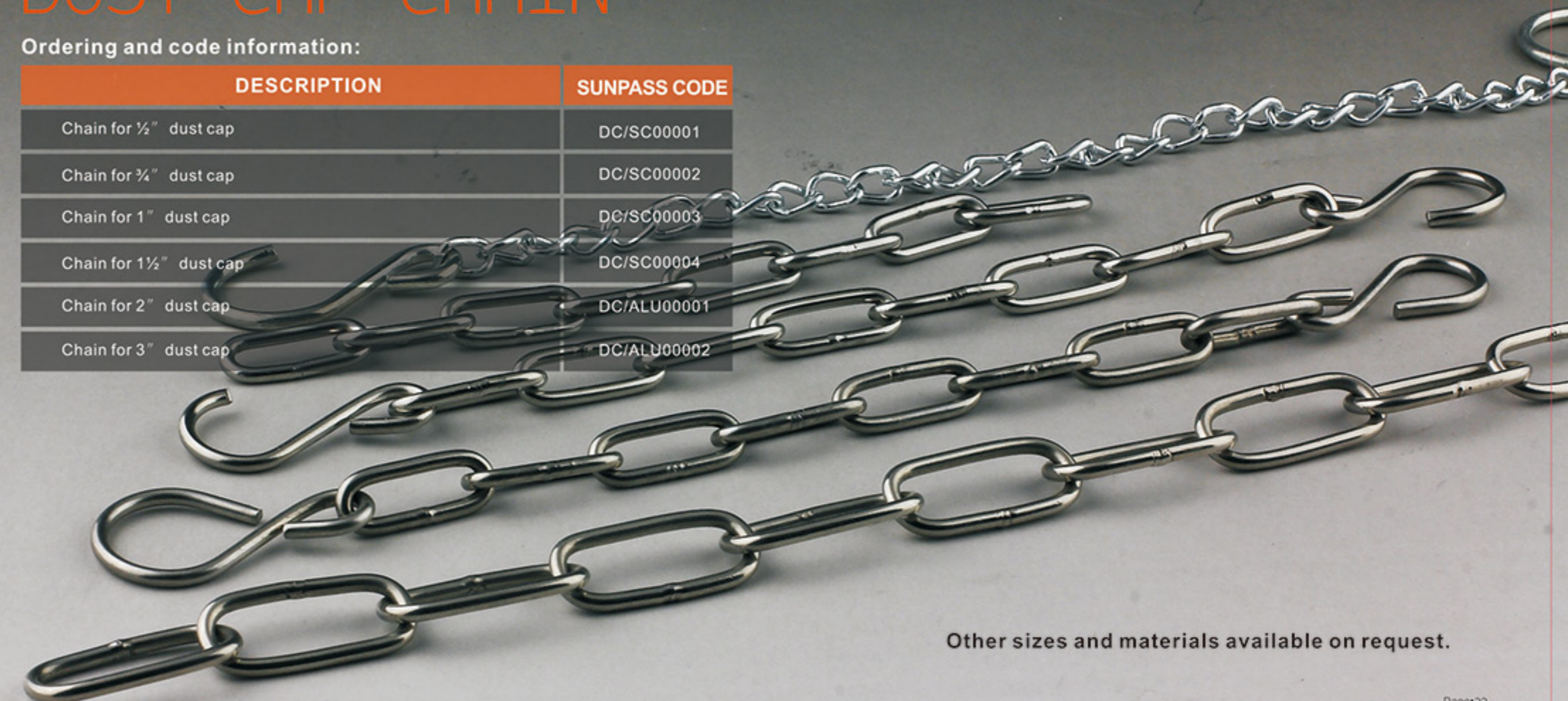

STAINLESS STEEL FLANGE

Description

We are engaged in supplying stainless steel flanges that have application in Tank Container. These flanges are made with stainless steel and are tough enough to survive various temperatures. We offer flanged that are manufactured with latest technology and are widely demanded for rust resistance, durability and smooth finishing. These products are available in different types.

Ordering and code Information:

SUNPASS CODE	DESCRIPTION
SF00001	Outlet flange square 3" BSP
SF00002	Flange dia.200mmx89.5mmx14mm/4XΦ18/PCD160mm
SF00003	Bland flange dia.200mmX10mm/4XΦ18mm/PCD160mm
SF00004	Bland flange dia.150mmX10mm/4XΦ18mm/PCD110mm
SF00005	Bland flange dia.165mmX10mm/4XΦ18mm/PCD125mm
SF00006	Blind flange dia. 200mmX10mm/6XΦ15mm/PCD168mm
SF00007	Blind flange dia.150mmX10mm/ /4xΦ18mm/ PCD 110mm

We can produce other size material according draws or samples.



Description:

Clamped type flame gauze trap are available for fort vale relief valves and designed to be Clamped around the valve body when transporting inflammable cargos.

The gauze is constructed from stainless steel wire.

STAINLESS STEEL PV VALVE FLAME GAUZE

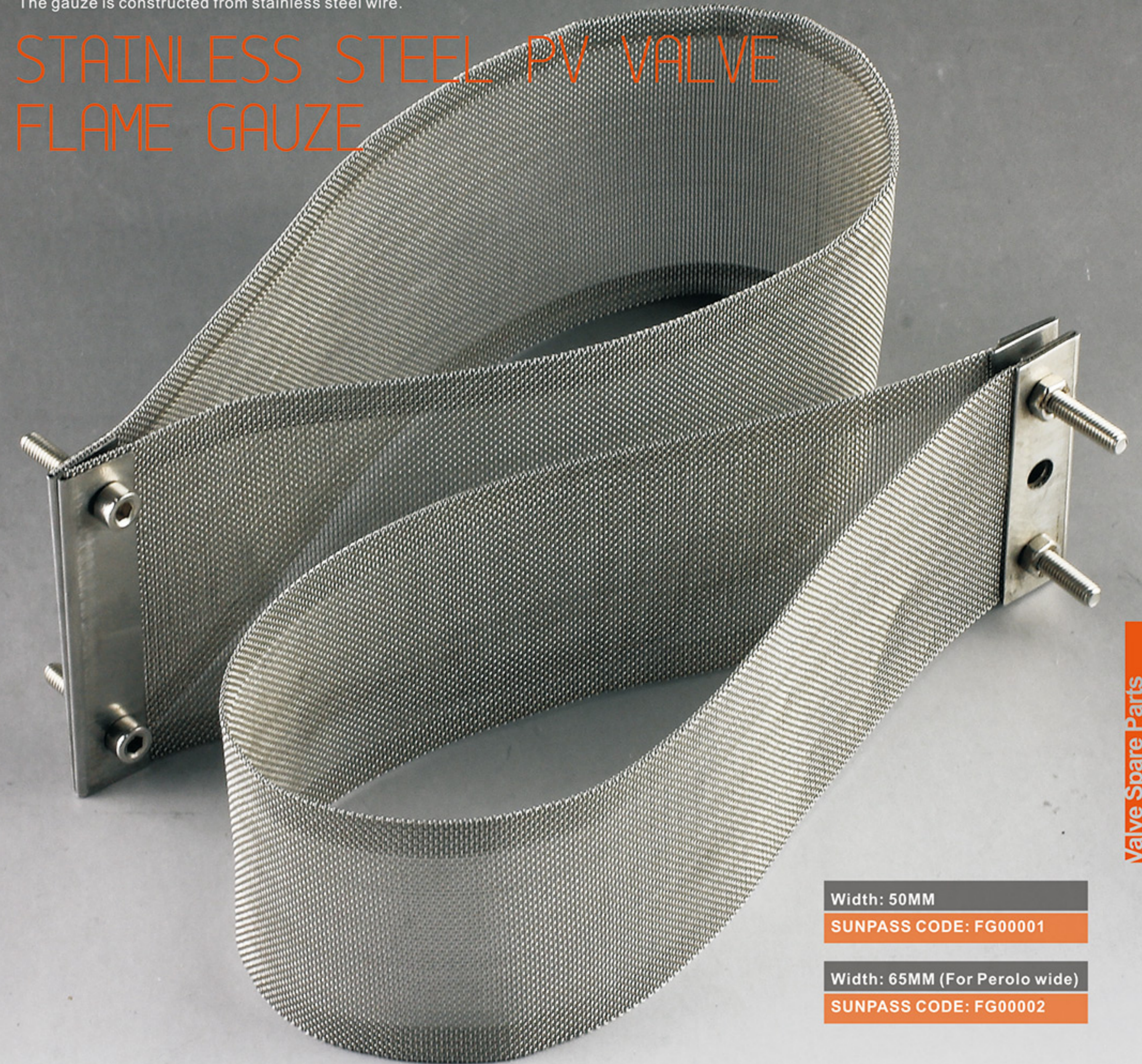

Width: 50MM

SUNPASS CODE: FG00001

Width: 65MM (For Perolo wide)

SUNPASS CODE: FG00002

ONE WAY STAINLESS STEEL BALL VALVE

Ordering and code information:

SUNPASS CODE	DESCRIPTION
BS00001	3" BSP FEMALE BALLVALVE SOLID-BODY
BS00002	2" BSP FEMALE BALLVALVE SOLID-BODY
BS00003	1 1/2" BSP FEMALE BALL VALVE SOLID-BODY
BS00004	1" BSP FEMALE BALLVALVE SOLID-BODY
BS00005	3/4" BSP FEMALE BALLVALVE SOLID-BODY
BS00006	1/2" BSP FEMALE BALL VALVE SOLID-BODY
BS00007	3/8" BSP FEMALE BALLVALVE SOLID-BODY
BS00008	1/4" BSP FEMALE BALLVALVE SOLID-BODY

We can supply other size, material or thread according customers requests



Other Spare Parts

THERMOMETER

4" Thermometer

SUNPASS 4"ND 100 thermometer is designed to be fitted on tank containers in order to measure Temperature.

Features :

- 304 Stainless steel case
- Stainless steel front flange
- Dual Temperature Celsius & Fahrenheit.
- Glycerin filled
- 4" , ND 100
- Back connection
- Brass movement
- Wire length : 1M/2M/3M
- Front flange
- Roll ring



Ordering and code information:

SUNPASS CODE	DESCRIPTION
TG00001	4" Temperature Capillary Filled Oil -20/150C
TG00002	4" Temperature Capillary Filled Oil -20/160C
TG00003	4" Temperature Capillary Filled Oil -40/160C
TG00004	4" Temperature Capillary Filled Oil -20/200C

Other sizes and scales available on request.

Ordering and code information:

CODE	DESCRIPTION
MG00001	63mm/0-7bar/psi/brass bottom connection/glycerin / 1/4"bsp
MG00002	63mm/0-7bar/psi/full SS bottom connection/glycerin / 1/4"bsp
MG00003	63mm/0-6bar/psi/brass bottom connection/glycerin / 1/4"bsp
MG00004	63mm/0-10bar/psi/brass bottom connection/glycerin / 1/4"bsp
MG00005	63mm/0-6bar/psi/full SS bottom connection/glycerin / 1/4"bsp
MG00006	63mm/0-40bar/psi/brass bottom connection/glycerin / 1/4"bsp
MG00007	63mm/0-100bar/psi/brass bottom connection/glycerin / 1/4"bsp with drag-pointer
MG00008	63mm/0-100bar/psi/full SS bottom connection/glycerin / 1/4"bsp with drag-pointer
MG00009	63mm/-1-7bar/psi/full SS bottom connection/glycerin / 1/4"bsp
MG00010	50mm/0-7bar/psi/brass bottom connection/glycerin / 1/4"bsp

Other size and scales are available on request



PRESSURE GAUGE

SUNPASS pressure gauges to measure and display tank pressure.

Description:

- Case Nominal Diameter: 50mm, 63mm
- Case Material: Stainless Steel
- Movement: Stainless steel or brass internal parts depending on request
- Connection: Bottom Connection, Center Back Male
- Connection depending on request
- Inlet Thread: 1/4" BSP
- Filled oil: Glycerine
- Dual pressure scale, bar & psi
- Aluminum pointer
- Accuracy: 2.5%

Other Spare Parts

DOCUMENT HOLDER

SUNPASS CODE DH00003: DOCUMENT HOLDER 75MM GREY

We can produce document holder as customers design or request



Other Spare Parts

DATA PLATE STAINLESS STEEL

Ordering and code information:

CODE	DESCRIPTION	SIZE
DP00001	Data Plate Combined	500mm X390mmX1mm
DP00002	Date Plate For Tank	200mmX340mmX1mm
DP00003	Consolidated Date Plate	500mmX210mmX1mm
DP00004	Calibration Date Plate 21,000LT	248mmX143mmX1mm
DP00005	Calibration Date Plate 24,000LT	248mmX143mmX1mm
DP00006	Calibration Date Plate 25,000LT	248mmX143mmX1mm

Other sizes and material available on request.



Other Spare Parts



WALKWAY

Aluminum Walkway Description:

1. Material: aluminum
2. For tank container use.

Ordering and code information:

SUNPASS CODE	SIZE
WW001	400mmx40mmx5.8m/2.5mm(T)
WW002	480mmx40mmx5.8m/2.5mm(T)
WW003	480mmx50mmx5.8m/2.5mm(T)

STAINLESS STEEL TIR PIN

Ordering and code information:

CODE	DESCRIPTION
TP00001	TIR PIN STRAIGHT MODEL SS
TP00002	TIR PIN L-MODEL SS



ALUMINIUM RIVET

Ordering and code information:

SUNPASS CODE	SIZE
RV4.8/11/16	4.8MM*11MM*DK16MM
RV4.8/20/46	4.8MM*20MM*DK46MM
RV4.8/11/9.5	4.8MM*11MM*DK9.5MM
RV4.8/20/9.5	4.8MM*20MM*DK9.5MM

Other sizes and material available on request.



SPARE PARTS FOR DRY CONTAINER

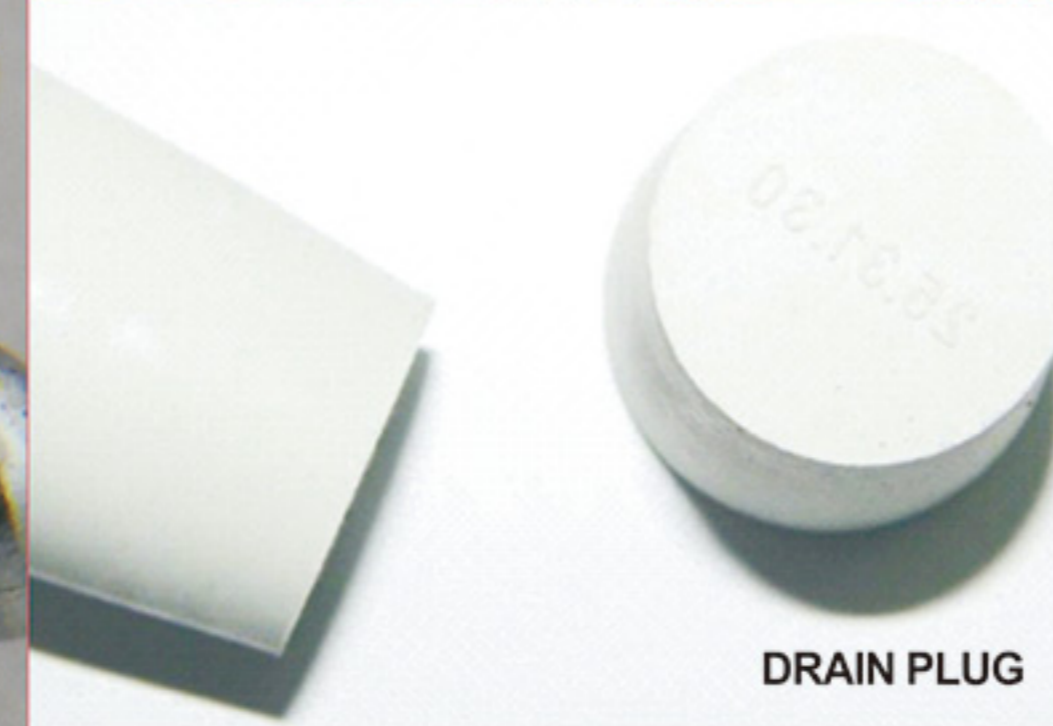

DRAIN PLUG

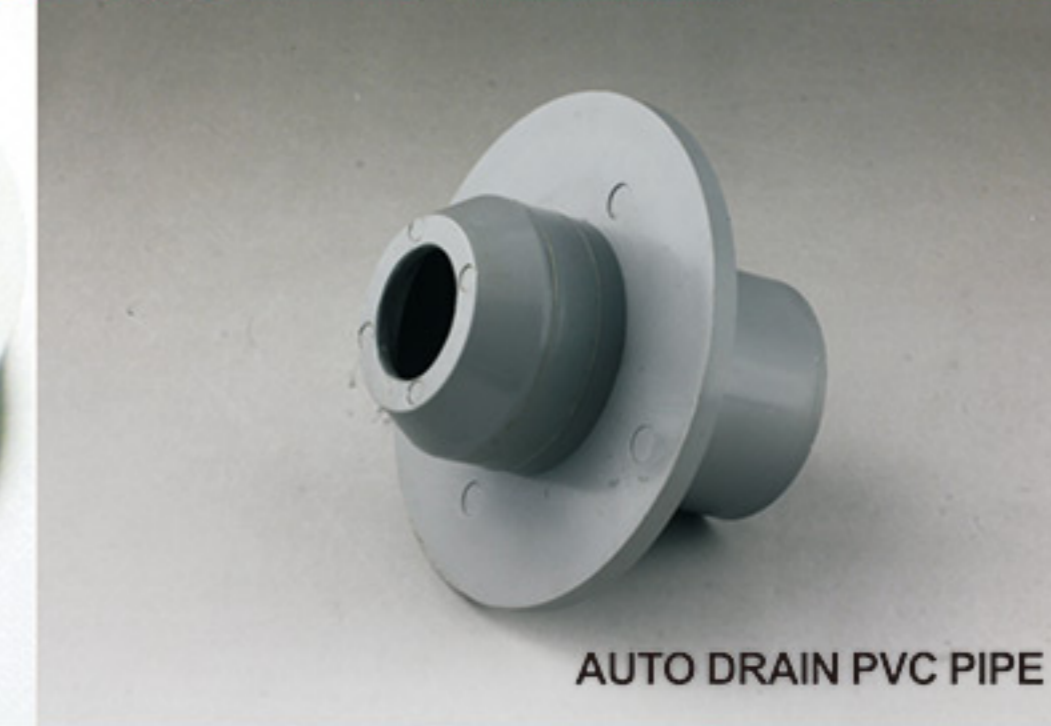

AUTO DRAIN PVC PIPE

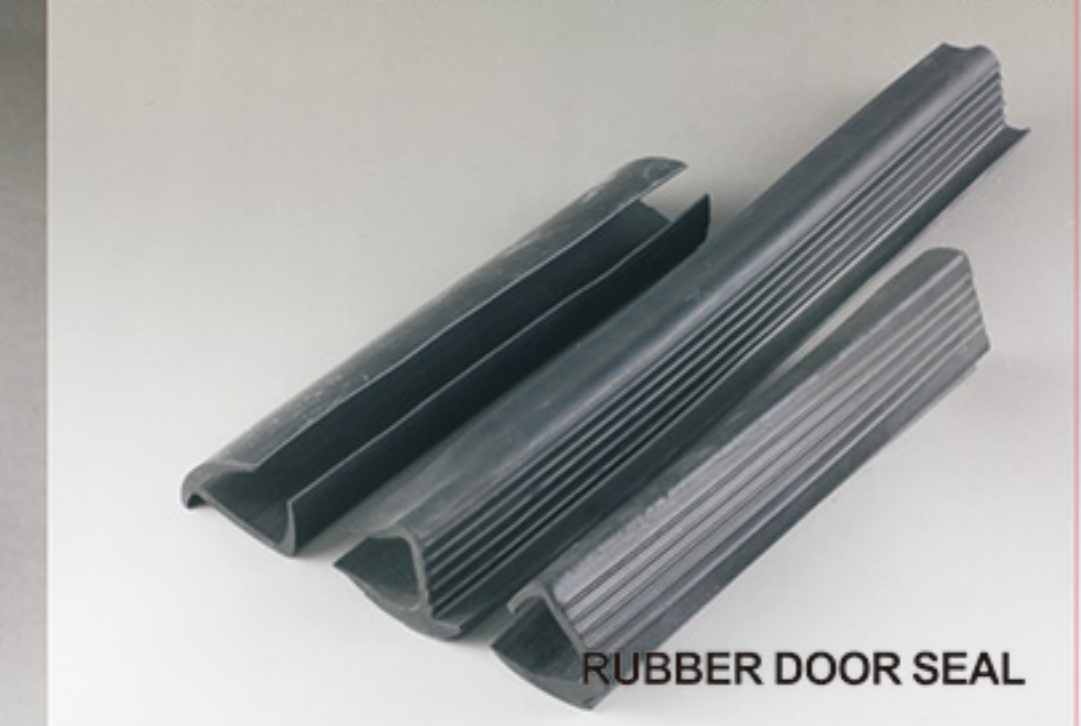

RUBBER DOOR SEAL



D-RING

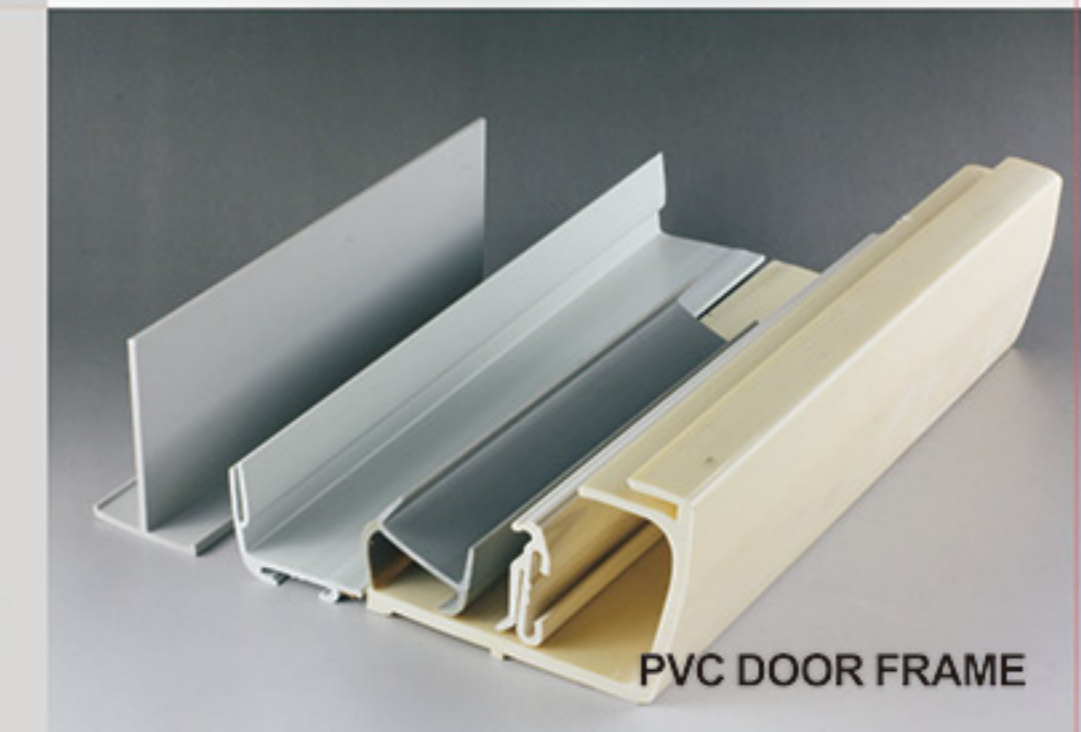

PVC DOOR FRAME



RUBBER KAZOO



DECK SCREW



AIR VENT