

2MP LPR Starlight AF Network IR Bullet Camera

IPC262EBR9-DUPZIT



Key Features

Optics

- Starlight illumination
- Up to 120 dB WDR(Wide Dynamic Range)
- Smart IR, up to up to 100m (328 ft) IR distance
- Optical glass window with higher light transmittance
- IR anti-reflection window to increase the infrared transmittance
- Day/night functionality

Compression

- Ultra 265,H.265, H.264, MJPEG
- Embedded smart algorithm
- Triple streams
- ROI (Region of Interest)
- 9:16 corridor mode
- Customized OSD
- Support Ipr

Network

- ONVIF Conformance

Structure

- Support PoE power supply
- Wide temperature range: -40°C to 60°C (-40°F to 140°F)
- Wide voltage range of ±25%
- IP67
- 3-Axis

Specifications

Camera	IPC262EBR9-DUPZIT				
Sensor	1/2.8", progressive scan, 2 megapixel, CMOS				
Lens	4.7~47mm@ F1.6(W)~3.0(T); AF automatic focusing and motorized zoom lens				
Iris	DC-Iris				
DORI Distance	Lens	Detect(m)	Observe(m)	Recognize(m)	Identify(m)
	4.7mm	72.9	29.2	14.6	7.3
	47mm	729.3	291.7	145.9	72.9
Angle of View (H)	53.8°~6.6°				
Angle of View (V)	29.3°~3.7°				
Angle of View (O)	66.2°~7.8°				
Adjustment angle	Pan: 0°~360°		Tilt: 0°~90°		Rotate: 0°~360°
Shutter	Auto/Manual, 1~1/100000s				
Minimum Illumination	Colour: 0.001 Lux (F1.6, AGC ON) 0 Lux with IR				
Day/Night	IR-cut filter with auto switch (ICR)				
Digital noise reduction	2D/3D DNR				
S/N	>52dB				
IR Range	up to 100m (328ft) IR range				
Defog	Digital Defog				
WDR	120dB				
Video					
Video Compression	Ultra 265, H.265, H.264, MJPEG				
H.264 code profile	Baseline profile, Main Profile, High Profile				
Frame Rate	Main Stream:1080P (1920×1080): Max. 60 fps; Sub Stream:1080P (1920×1080): Max. 60 fps; Third Stream:D1 (720×576): Max. 60 fps;				
9:16 Corridor Mode	Supported				
HLC	Supported				
BLC	Supported				
OSD	Up to 8 OSDs				
Privacy Mask	Up to 8 areas				
ROI	Up to 8 areas				
Motion Detection	Up to 4 areas				

Smart	
Behavior Detection	Intrusion, cross line, motion detection
Intrusion	Enter and loiter in a pre-defined virtual region
cross line	Cross a pre-defined virtual line
motion detection	Moving within a pre-defined virtual region
Recognition	Face detection, Audio detection, lpr
Intelligent Identification	Defocus, Scene Change, Object Left, Object Moving
Statistical Analysis	People counting
General Function	Watermark, IP Address Filtering, Tampering Alarm, Alarm input, Alarm output, Access Policy, ARP Protection, RTSP Authentication, User Authentication
Audio	
Audio Compression	G.711
Suppression	Supported
Sampling Rate	8 KHZ
Storage	
Edge Storage	Micro SD, Up to 256 GB
Network Storage	ANR
Network	
Protocols	IPv4, IGMP, ICMP, ARP, TCP, UDP, DHCP, PPPoE, RTP, RTSP, RTCP, DNS, DDNS, NTP, FTP, UPnP, HTTP, HTTPS, SMTP, 802.1x, SNMP
Compatible Integration	ONVIF(Profile S, Profile G), API
Interface	
Audio I/O	Audio cable
	1 Input: impedance 35 kΩ; amplitude 2 V [p-p]
	1 Output: impedance 600 Ω; amplitude 2 V [p-p]
Alarm I/O	2 / 1
Serial Port	1 RS485
Network	1 RJ45 10M/100M Base-TX Ethernet
Video Output	1 BNC, impedance 75 Ω; amplitude 1 V [p-p]
General	
Power	AC24V ± 25%、DC12V ± 25%, PoE (IEEE802.3 at)
	Power consumption: 14W
Dimensions (L × W × H)	305.5 × 104.1 × 97.3mm (12.0" × 4.1" × 3.8")
Weight	1.65 kg (3.6 lb)
Working Environment	-40°C ~ +60°C (-40°F ~ 140°F)
	Humidity :10%~90% RH(non-condensing)
Ingress Protection	IP67
Reset Button	Supported

Dimensions

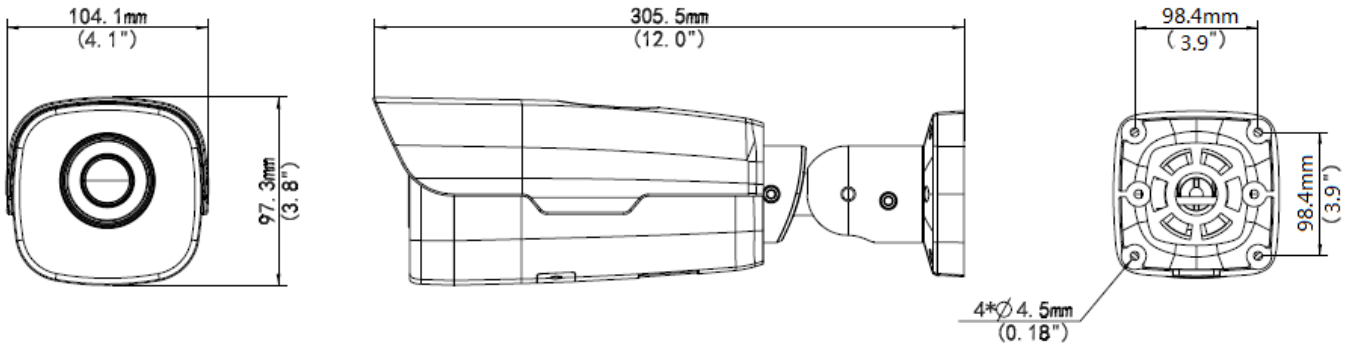

Zhejiang Uniview Technologies Co., Ltd.

South Tower, Building 10, Wanlun Science Park, 88 Jiangling Road, Hangzhou, P.R.China 310051

Email: overseasbusiness@uniview.com; globalsupport@uniview.com

<http://www.uniview.com>

©2018 Zhejiang Uniview Technologies Co., Ltd. All rights reserved.

*Product specifications and availability are subject to change without notice.