

# GD20/GD200A Series

General Purpose Vector Control Drive



<b>Product Instruction</b> .....	2
Product Advantage .....	2
<b>GD20 Series Mini Vector Inverters Product Introduction</b> .....	3
Product Advantage.....	3
Product Features .....	4
New Structure Design .....	4
Easy Maintenance .....	4
Reliable QA .....	4
Excellent Performance .....	5
Multi-function and Easy To Use .....	6
Main Applications .....	7
Technical Parameters.....	8
Standard Wiring .....	9
Type Designation Key .....	9
Wall Installation .....	10
Rail Installation.....	10
<b>GD200A Series General Purpose Inverters Product Introduction</b> .....	11
Product Advantage.....	11
High Performance.....	12
High Performance .....	12
Main Applications.....	16
Technical Specifications .....	16
Standard Wiring.....	18
Wiring Diagram of the Main Circuit .....	18
Wiring Diagram of the Control Circuit.....	18
Type Selection.....	19
Power Ratings and Out Packing.....	19
Installation Dimension Table.....	20
Installation Diagram.....	21
Optional Parts.....	23
Sales Network.....	26

# Low Voltage Drive Family

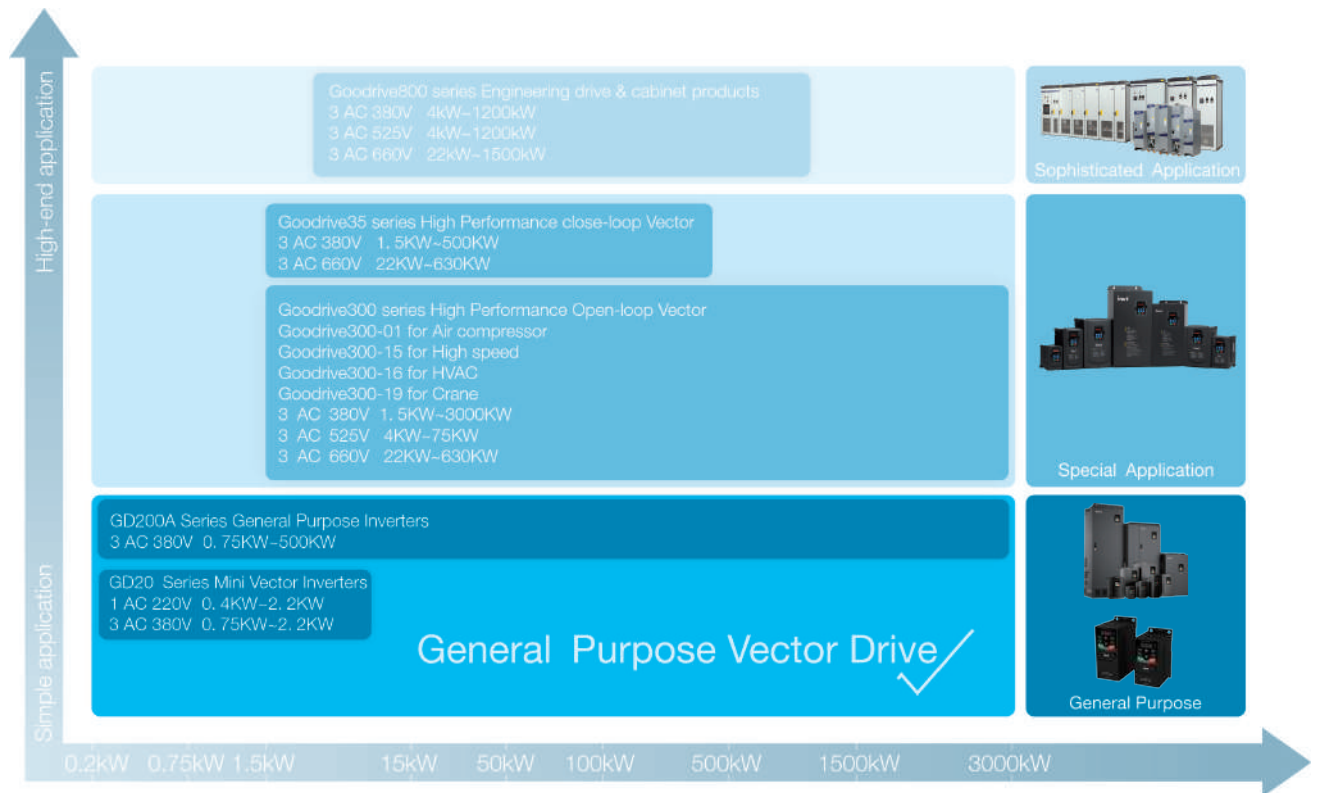

## Product Instruction

GD20&GD200A series inverters are new generation product of the inverter, with rich product type and wide range of power, can be widely use to fan and water pump. Products based on the vector V/F control, and realize the accurate parameter of motor Auto-turning, high precision speed control. To effectively improve the reliability of the product and the environment.

At the same time, with more rich function and more flexible application, the series products can strengthen the customer's easy to use.

## Product Advantage

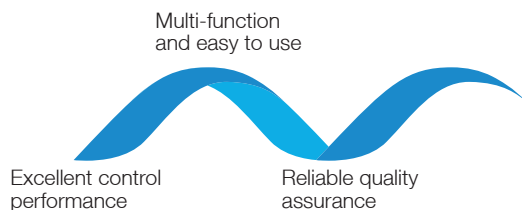



## GD20 Series Mini Vector Control Drive Product Introduction

GD20 series mini type general vector inverter, positioned as using the high performance mini product of small power market; product using the leading international vector control algorithm, with excellent product features, compatible with wall and rail installation, and the product volume is smaller. Product widely used in Textile machinery, Food machinery, Plastic machinery, Printing and packaging, Environmental protection equipment, Ceramic equipment, Woodworking equipment, Conveying equipment and so on industries.

## Product Advantage

- Mini structure
- Easy maintenance
- Various installation ways
- Excellent performance
- Multi-function and easy to use



# / Product Features

## New Structure Design

- Mini design, smaller installation space



- Compatible with rail and wall installation, flexible installation manner



Rail mounting



Wall mounting

- Available multi-inverter in parallel installation, more effective space-saving



## Easy Maintenance

- External keypad  
The standard keypad is membrane keypad. Support external LED keypad. The LED keypad support parameter copy.



## Reliable QA

- The product design strictly follows IEC international standards and passes the CE test



- Plug cooling fan, easy maintenance



- Advanced thermal technology makes exact thermal design

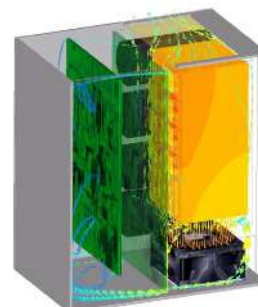

Excellent Performance

- Excellent vector control performance

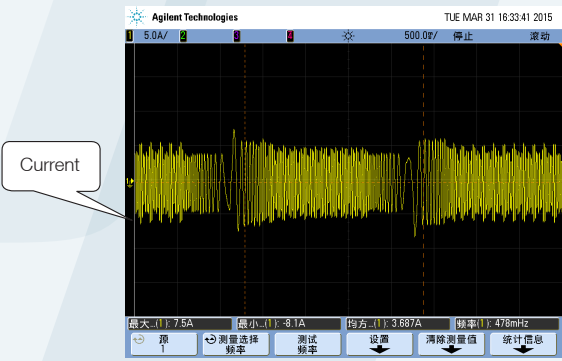

Current waveforms in vector control mode with 50Hz and full load

- Excellent motor drive performance

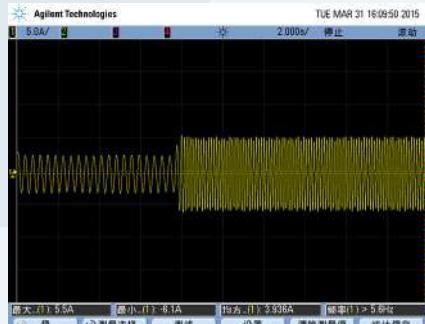

Current waveforms when sudden loading in V/F control mode with 2Hz and full load

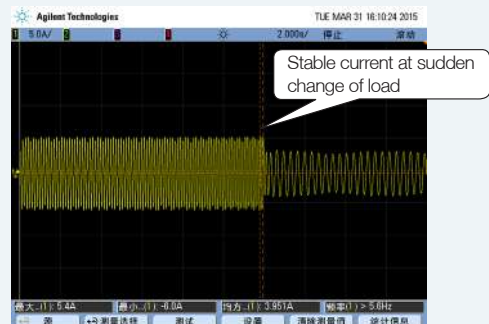

Current waveforms when sudden unloading in V/F control mode with 2Hz and full load

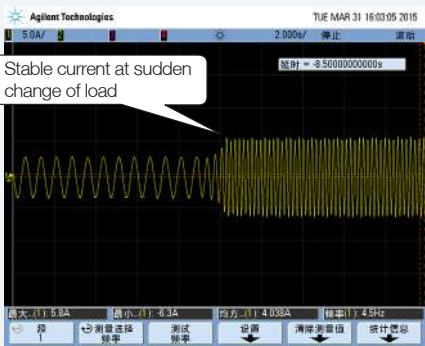

Current waveforms when sudden loading in vector control mode with 0.5Hz and full load

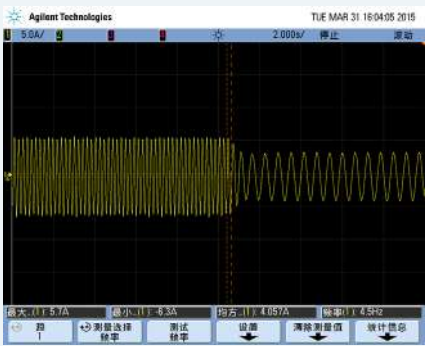

Current waveforms when sudden unloading in vector control mode with 0.5Hz and full load

- Excellent high frequency running performance

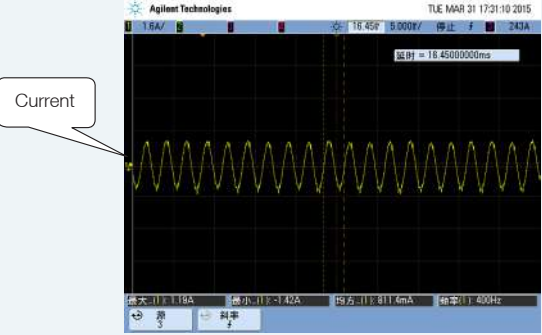

Current waveforms when stably running in vector control mode with 400Hz

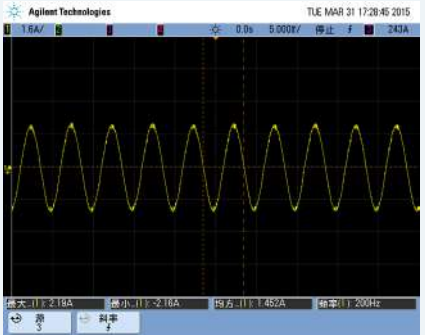

Current waveforms when stably running in vector control mode with 200Hz

### Multi-Function and Easy to Use

Name	Function	Illustration
485 communication interface	Connect with upper computer, read and modify parameters of the inverter, control running states of the inverter	Standard built-in 485 communication interface
PID	Carry out PID operation on feedback signals, control output frequency of the inverter and improve target accuracy and stability; apply to pressure, flow and temperature process control	Support PID output polarity switching
Motor autotuning	Carry out rotation or static autotuning, improve control accuracy and response speed	Include rotation autotuning and static autotuning
Simple PLC	Can change the running frequency and direction automatically according to the running time set by simple PLC to meet process requirements	Support multiple running modes
Multi-step speed control	Can meet the requirements of speed control in different periods of time via multi-step speed control	Max. available 16-step speed control
Multiple V/F curve settings	Meet the requirements of fans and water pumps in energy-saving operation and various variable frequency power supplies, adapt to different load applications	Linear, multi-dot, multi-power and V/F separation settings, realize flexible setting of V/F curves
Virtual terminals	Can take external signals as local virtual I/O to save hardware configuration	Enable the corresponding virtual terminal functions in communication mode
Delay switching on and off	Provide more programming and control modes	Max. switching on-off delay is 50s
Continuous running in instantaneous power off	Specially apply to the situations with high requirement of continuous operation, ensure the device does not stop in instantaneous power off	At transient voltage drop, the inverter can keep running by feedback energy without stop in valid time
Various protection functions	Provide overall fault protection functions	Protection functions such as overcurrent, overvoltage, undervoltage, overheating, overload, can save fault information
Optional braking modes	Provide multiple braking modes, satisfy accurate and quick stop under different loads	DC braking, flux braking, short-circuit braking
Battery capacity display	Can display the accumulative power consumption on the inverter in no need of watt-hour meter	Can check power consumption of the inverter

# Main Applications



Textile machinery



Food machinery



Plastic machinery



Printing and packaging



Environmental protection equipment



Ceramic equipment



Woodworking equipment



Conveying equipment



# Technical Specifications

	Function	Specification
Power input	Input voltage (V)	1PH 220V (-15%)~240V(+10%) 3PH 380V (-15%)~440V(+10%)
	Input current (A)	Refer to the rated value
	Input frequency (Hz)	50Hz or 60Hz, allowed range: 47~63Hz
Power output	Output motor capacity (kW)	Refer to the rated value
	Output current (A)	Refer to the rated value
	Output voltage (V)	0-Input voltage, error<5%
Technical control feature	Control mode	SVPWM, SVC
	Adjustable-speed ratio	1:100
	Speed control accuracy	±0.2% (SVC)
	Speed fluctuation	± 0.3% (SVC)
	Torque response	<20ms (SVC)
	Torque control accuracy	10%
	Starting torque	0.5Hz/150% (SVC)
Running control feature	Overload capability	150% of rated current: 1 minute 180% of rated current: 10 seconds 200% of rated current: 1 second
	Frequency setting method	Digital setting, analog setting, pulse frequency setting, multi-step speed running setting, simple PLC setting, PID setting, MODBUS communication setting
	Auto-adjustment of the voltage	Keep a stable voltage automatically when the grid voltage transients
Peripheral interface	Fault protection	Provide comprehensive fault protection functions: overcurrent, overvoltage, undervoltage, overheating, phase loss and overload, etc.
	Analog input	1 (AI2) 0~10V/0~20mA and 1 (AI3) -10~10V
	Analog output	2 (AO1, AO2) 0~10V/0~20mA
	Digital input	4 common inputs, the Max. frequency: 1kHz; 1 high speed input, the Max. frequency: 50kHz
	Digital output	1 Y terminal output; 2 programmable relay outputs
Others	Relay output	2 programmable relay outputs RO1A NO, RO1B NC, RO1C common terminal RO2A NO, RO2B NC, RO2C common terminal Contact capacity: 3A/AC250V
	Mountable method	Wall and rail mountable
	Braking unit	Embedded
	EMI filter	Optional filter: meet the degree requirement of IEC61800-3 C2, IEC61800-3 C3
	Temperature of the running environment	-10~50°C, derate above 40°C
	Altitude	<1000m If the sea level is above 1000m, please derate 1% for every additional 100m.
	Protective degree	IP20
	Safety	Meet the requirement of CE
Cooling	Air-cooling	

# Standard Wiring

Wiring diagram of control circuit

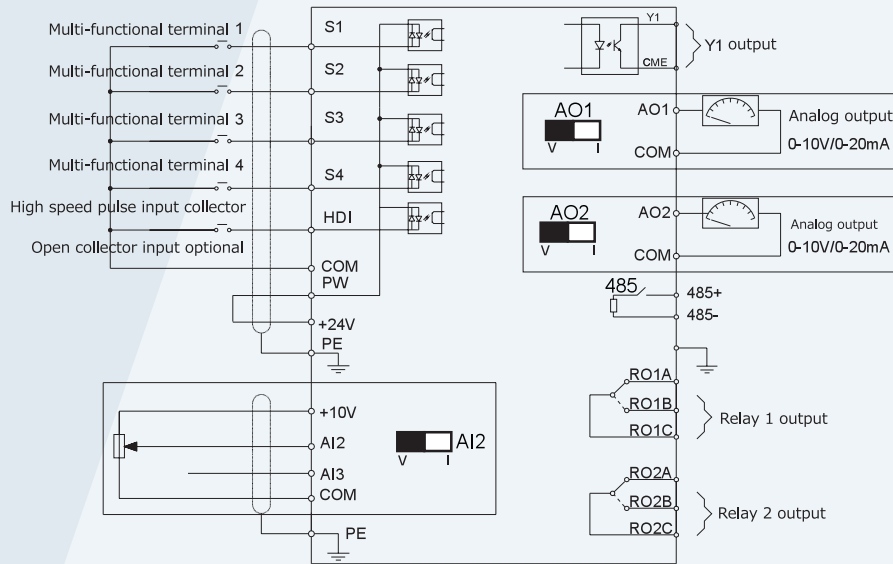

# Type Selection

Type designation key

**GD20 - 2R2G - 4 - UL**

①                      ②                      ③                      ④

Key	No.	Detailed description	Detailed content
Abbreviation	①	Product abbreviation	GD20 is short for Goodrive20
Rated power	②	Power range+load type	2R2-2.2kW G: constant torque load
Voltage degree	③	Voltage degree	S2: AC 1PH 220V(-15%)~240V(+10%) 4: AC 3PH 380V(-15%)~440V(+10%)
Certification	④	Certification standards	Default: CE: Meet EU CE certification requirements UL: Meet American UL certification requirements

Power Ratings And Dimension

Key	Rated output power(kW)	Rated input current(A)	Rated output current(A)	Gross weight (Kg)	Dimension (mm)
GD20-0R4G-S2	0.4	6.5	2.5	1.1Kg	215X125X180
GD20-0R7G-S2	0.75	9.3	4.2		
GD20-1R5G-S2	1.5	15.7	7.5	1.5 Kg	242X130X120
GD20-2R2G-S2	2.2	24	10		
GD20-0R7G-4	0.75	3.4	2.5	1.3 Kg	242X130X120
GD20-1R5G-4	1.5	5.0	3.7		
GD20-2R2G-4	2.2	5.8	5.5		

# Installation Dimension

## Wall Mounting

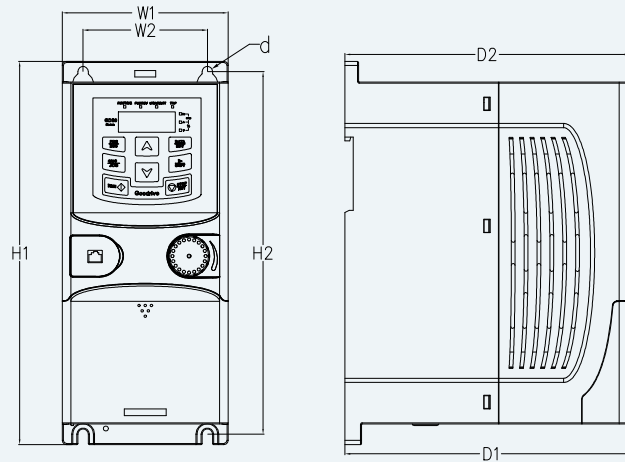

Installation dimension (unit: mm)

Model	W1	W2	H1	H2	D1	D2	Installation hole (d)
GD20-0R4G-S2	80.0	60.0	160.0	150.0	123.5	120.3	5
GD20-0R7G-S2	80.0	60.0	160.0	150.0	123.5	120.3	5
GD20-1R5G-S2	80.0	60.0	185.0	175.0	140.5	137.3	5
GD20-2R2G-S2	80.0	60.0	185.0	175.0	140.5	137.3	5
GD20-0R7G-4	80.0	60.0	185.0	175.0	140.5	137.3	5
GD20-1R5G-4	80.0	60.0	185.0	175.0	140.5	137.3	5
GD20-2R2G-4	80.0	60.0	185.0	175.0	140.5	137.3	5

## Rail Mounting

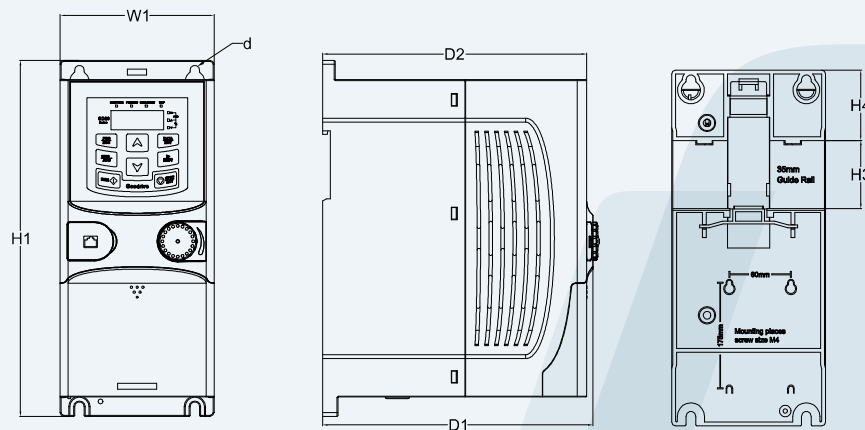

Installation dimension (unit: mm)

Model	W1	H1	H3	H4	D1	D2	Installation hole (d)
GD20-0R4G-S2	80.0	160.0	35.4	36.6	123.5	120.3	5
GD20-0R7G-S2	80.0	160.0	35.4	36.6	123.5	120.3	5
GD20-1R5G-S2	80.0	185.0	35.4	36.6	140.5	137.3	5
GD20-2R2G-S2	80.0	185.0	35.4	36.6	140.5	137.3	5
GD20-0R7G-4	80.0	185.0	35.4	36.6	140.5	137.3	5
GD20-1R5G-4	80.0	185.0	35.4	36.6	140.5	137.3	5
GD20-2R2G-4	80.0	185.0	35.4	36.6	140.5	137.3	5



## GD200A Series General Purpose Vector Control Drive Product Introduction

GD200A series high performance general vector inverter, positioned as a new generation general purpose inverter; products using DSP control system and vector V/F control technology, with excellent motor drive performance and various protecting functions, widely used in air compressor, plastic machine, petroleum industry, coal industry, HVAC applications, fan pump and other standard transmission load.

## Product Advantage

- High performance
- Multi-function with simple operation
- Reliable quality certificated



# High Performance

- More Accurate Motor Autotuning

Accurate rotating and static motor autotuning  
Convenient debugging and easy operation

Rotating autotuning	Static autotuning
De-couple form the load Applied to the situation with high control accuracy	No need to de-couple from the load Applied when rotating autotuning is not available

- Advanced open loop vector control

The current, torque and rotating speed waveforms when sudden loading or unloading in asynchronous motor open loop vector control mode with 0.5Hz running frequency and full load.

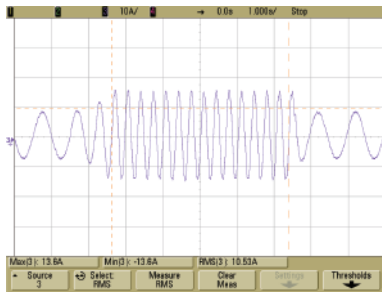

Current

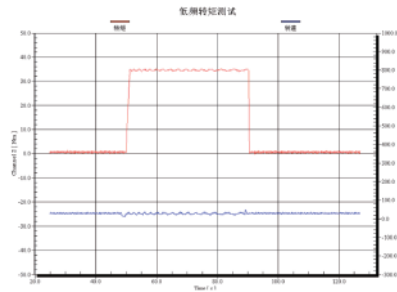

Torque & Rotating speed

- Perfect voltage and current control, reducing the fault protection times

**OC fault** Adjust the output frequency to avoid overcurrent of the inverter during acceleration

**OV fault** Adjust the output frequency to avoid overvoltage of the DC bus during deceleration

- Multiple braking modes and instant stopping

**Dynamic braking**

- Configure braking units and resistors
- Available on the situation of big inertia load and frequent braking
- Big braking torque and quick braking

**Flux braking**

- No need to configure braking units and resistors
- Available on the instant stopping situation with big inertia load and no frequent braking
- Not available on the situation of big inertia load and frequent braking (the energy consumed on the stator and its cooling is better than DC braking)

**DC braking**

- No need to configure braking units and resistors
- Available on the situation when start the running motor after braking and the situation when keep the moment output after braking to zero speed
- Not available on the situation of big inertia load or instant stopping braking in high speed running

**Short circuit braking**

- No need to configure braking units and resistors, capable of braking quickly
- Applicable to the motors at quick start and stop or restart after braking
- Not applicable to big inertia load and frequent braking

# Multi-Function with Simple Operation

## • Separate Air-duct

The separate air duct prevents the contaminants into the electronic parts/components and greatly improves the protective effect of the inverter, as well as its reliability and service life, to adapt various complicated site environments. It can also facilitate the heat-releasing in control cabinets and the heat-releasing design of the customer.

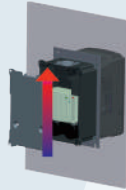

## • Multiple installation modes

0.75~200kW: Wall mounting and flange mounting  
200~315kW: Wall mounting and floor mounting  
350~500kW: Floor mounting

Remark: above power ratings are subject to G type machine.



## • Standard built-in C3 input filters, optional external C2 filters

C3 input filter is embedded in the factory to meet different application requirements, save installation space and avoid electromagnetic interference caused by incorrect selection and site installation.

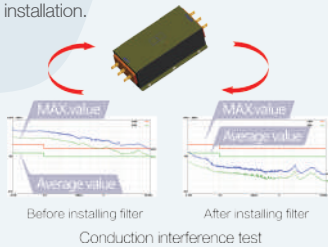

Remarks:  
C2 filter: EMC performance of the inverter achieves the limited usage requirement in civil environment.  
C3 filter: EMC performance of the inverter achieves the limited usage requirement in civil environment.

## • Book structure

Parallel installation  
Smaller installation space with less cost and beautiful appearance.



## • The rivet design ensures reliable integration connection

Greener Proper grounding  
Stronger corrosion-resistance Excellent EMC performance



## • Smaller Size

Due to the thermal simulation and advanced modularized design, the size of our product is reduced greatly. The width ratio between Goodrive300 and CHF100A is shown in the figure below (the Max. percentage is 50%)

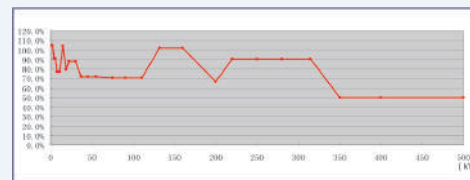

## • GD200A series

Membrane keypad design (which can be connected to external keypads) is available for inverters ( $\leq 15\text{kW}$ ); swappable keypads are standard for inverters ( $\geq 18.5\text{kW}$ )



Terminals	Quantity	Features
ON-OFF input	8 channels	1KHz NPN and PNP
High speed	0.75	9.3
Pulse input	1 channel	50KHz NPN and PNP
Analog input	2 channels	0~10V, 0~20mA, -10V~-+10V
ON-OFF output	1 channel	Max. output frequency: 1KHz
High speed	1.5	5.0
Pulse output	1 channel	Max. output frequency: 50KHz
Analog output	2 channels	0~10V, 0~20mA
Relay output	2 channels	3A/250DAC, 1A/30VDC, NO+NC

## • High Performance Keypad

External LED keypads are standard for inverters ( $\geq 18.5\text{kW}$ ) to support parameters upload and download, the maximum external length is 200M and the keypads have digital potentiometers; external keypads are optional for inverters ( $\leq 15\text{kW}$ ).



External keypad



LCD keypad

The optional external LCD keypad supports parameters loading and unloading with English.

## • Available on DC power supply

Reduce the occupied space and decrease the costsign of the customer.



## • Embedded braking units of 0.75-30kW inverters

Reduce the occupied space and decrease the costsign of the customer.

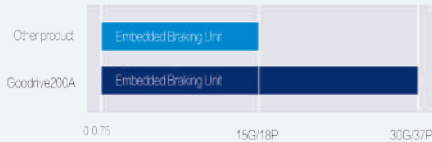

## • Function of water supply

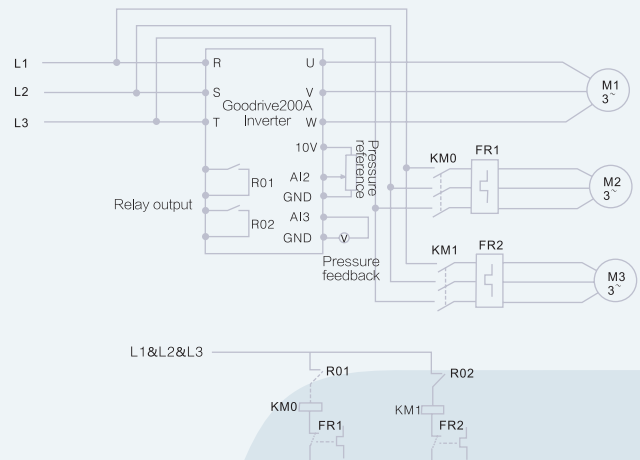

## • Supporting common DC bus

Reduce the power lost on DBR  
Note the impact current and the capacity of the input AC system

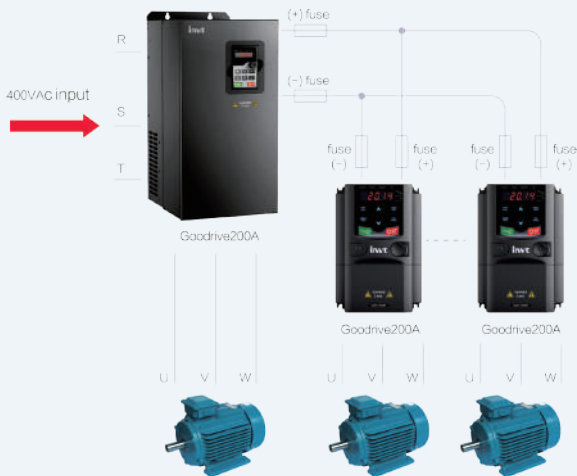

- The product design follows IEC national standards and passes the CE test certification.



Remarks:  
Each Goodrive200A inverter has past the test certification

- Advanced thermal technology makes exact thermal design

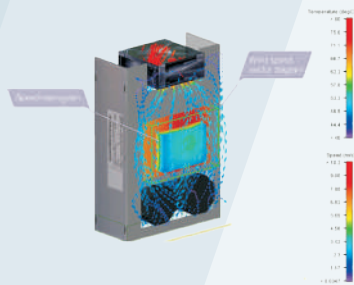

- Wide voltage range meets the requirement of grid environment

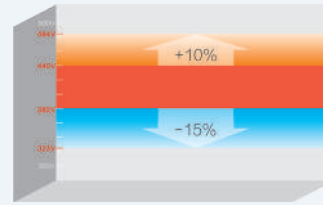

AC 3PH:380V(-15%)-440V(+10%) Wide voltage range

- Perfect and reliable test system ensure products adapt complicated site environments

Experiment type	Experiment name	Classification
Mechanical reliability experiments	Package experiments	Package compression experiments
		Package resonance imaging and storage test
		Package random vibration test
		Package dropping test
		Package rolling test
		Package dumping test
		Package inclined impact test
Mechanical reliability experiments	Impact test	Half-sine wave impulse test(non-working state) Trapezoidal wave impulse test (non-working state)
	Vibration test	Sinusoidal vibration test (working state)
		Random vibration test (working and non-working state)
Climatic environmental reliability test	Temperature experiment	Low temperature storage test High temperature storage test Low temperature experiments High temperature experiments Temperature gradient experiments Temperature impact test
Climatic environmental reliability test	Thermal test	Constant thermal test Alternation thermal test
	Salt spray test	Constant salt spray test Alternation salt spray test
	Low air pressure test	Low Air Pressure Test
		Low temperature and low pressure test High temperature and low pressure test

Remarks:

INVT is the only manufacturer achieved ACT certificate of TÜV SÜD .The full name of ACT is Acceptance of Client's Testing, which means the German TÜV SÜD admit the technology level of the lab and accept their separate testing data and test reports officially.



Electric Vibration System



Low Pressure Test Chamber (L)  
Constant Temperature and Humidity Test Chamber (R)



Natural Convection Test Chamber (L)  
Thermal Shock Test Chamber (R)



# / Main Applications

---



Air compressor



Oil industry



Warming and water supply



Plastics machine



Mining



Fans and water pumps

# Technical Specifications

Function		Illustration
Input	Input voltage (V)	AC 3PH 400V±15%
	Input current (A)	Refer to the rated value
	Input frequency (Hz)	50Hz or 60Hz Allowed range: 47~63Hz
Output	Output voltage (V)	0~input voltage
	Output frequency (Hz)	0~400Hz
Technical control feature	Control mode	V/F
	Motor type	Asynchronous motor
	Speed ratio	Asynchronous motor 1:100
	Overload capability	G type: 150% of rated current: 1 minute 180% of rated current: 10 seconds 200% of rated current: 1 second P type: 120% of rated current: 60 second
	Torque overload capacity	G type: 150% for machines 180 % for quick response machines P type: 120% for pump and fan
Running control feature	Frequency setting	Digital setting, analog setting, pulse frequency setting, multi-step speed running setting, simple PLC setting, PID setting, MODBUS communication setting, PROFIBUS communication setting. Realize the shifting between the set combination and set channel.
	Auto voltage adjustment	Keep a stable voltage automatically when the grid voltage transients
	Fault protection	Provide over 30 fault protection functions: overcurrent, overvoltage, undervoltage, overheating, phase loss and overload, etc.
	Speed tracking	Restart the rotating motor smoothly
Peripheral interface	Terminal analog input resolution	≤10mV
	Terminal switch input resolution	≤ 2ms
	Analog input	2 channels (AI1, AI2) 0~10V/0~20mA and 1 channel (AI3) -10~10V
	Analog output	2 channels (AO1, AO2) 0~10V /0~20mA
	Digital input	8 channels common input, the Max. frequency: 1kHz 1 channel high speed input, the Max. frequency: 50kHz
	Digital output	1 channel high speed pulse output, the Max. frequency: 50kHz; 1 channel Y terminal open collector pole output
Others	Relay output	2 channels programmable relay output RO1A NO, RO1B NC, RO1C common terminal RO2A NO, RO2B NC, RO2C common terminal Contactor capability: 3A/AC250V,1A/DC30V
	Mountable method	Wall, flange and floor mountable
	Temperature of the running environment	-10~50°C, derate above 40°C
	Ingress protection	IP20
	Cooling	Air-cooling
	Braking unit	Built-in braking unit for below 30G/37P (including 30G/37P) External braking unit for others
	Braking resister	External braking
	EMC filter	Optional built-in C3 filter: meet the degree requirement of IEC61800-3 C3 Optional external filter ,meet the degree requirement of IEC61800-3 C2

# Standard Wiring

## Wiring diagram of the main circuit

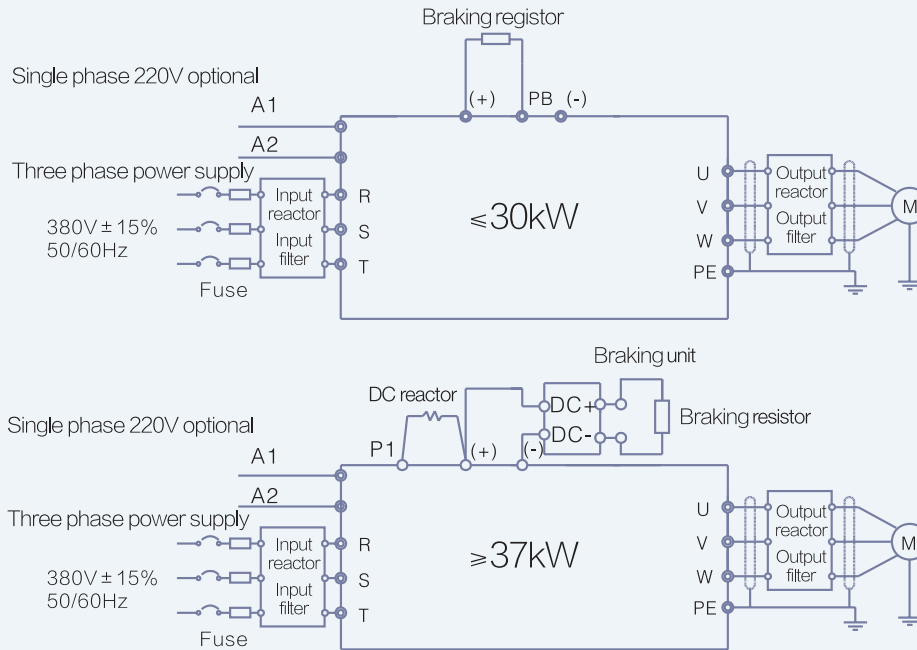

## Wiring diagram of the control board

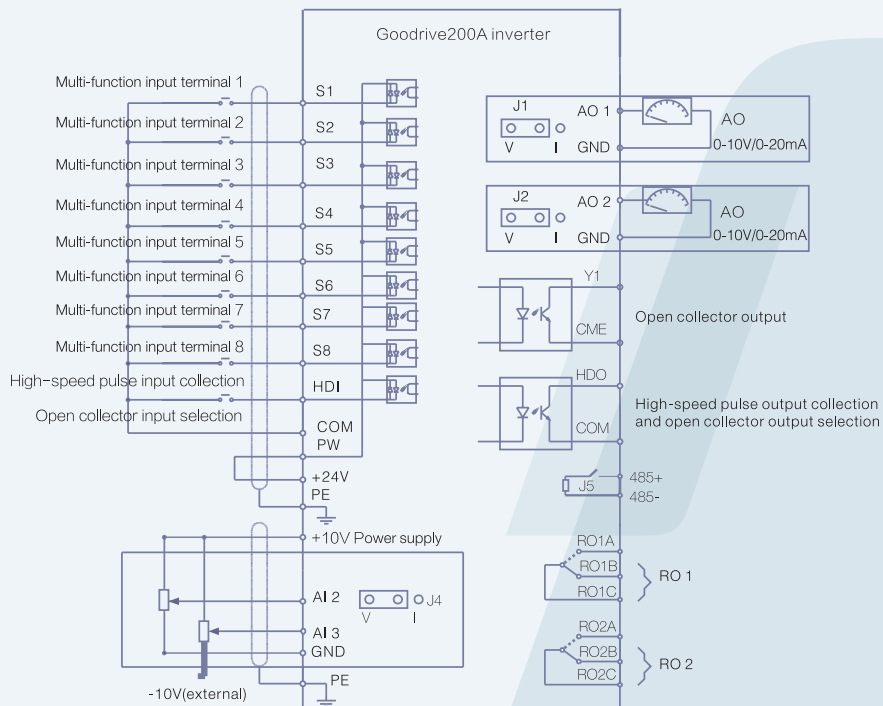

# Type Selection

## Power ratings And Dimension

Inverter model	Rated output power (kW)	Input current (A)	Rated output current (A)	Gross weight (Kg)	Dimension (mm)
3-phase 220VAC±15%					
GD200A-0R75G-2	0.75	5	4.5	4.1kg	360x250x265
GD200A-1R5G-2	1.5	7.7	7		
GD200A-2R2G-2	2.2	11	10	7.4kg	445x295x320
GD200A-004G-2	3.7	17	16		
GD200A-5R5G-2	5.5	21	20	11kg	550x375x375
GD200A-7R5G-2	7.5	31	30		
GD200A-011G-2	11	43	42	32kg	695x410x470
GD200A-015G-2	15	56	55		
GD200A-018G-2	18.5	71	70	67kg	760x445x580
GD200A-022GP-2	22	81	80		
GD200A-030G-2	30	112	110	67kg	760x445x580
GD200A-037G-2	37	132	130		
GD200A-045G-2	45	163	160	67kg	760x445x580
GD200A-055G-2	55	181	190		
3-phase 380VAC±15%					
GD200A-0R75G-4	0.75	3.4	2.5	2.5kg	275 x205 x235
GD200A-1R5G-4	1.5	5.0	3.7		
GD200A-2R2G-4	2.2	5.8	5	4.1kg	360 x250 x265
GD200A-004G/5R5P-4	4/5.5	13.5/19.5	9.5/14		
GD200A-5R5G/7R5P-4	5.5/7.5	19.5/25	14/18.5	7.4kg	445 x295 x320
GD200A-7R5G/011P-4	7.5/11	25/32	18.5/25		
GD200A-011G/015P-4	11/15	32/40	25/32	9kg	460 x340 x330
GD200A-015G/018P-4	15/18.5	40/47	32/38		
GD200A-018G/022P-4	18.5/22	47/56	38/45	11kg	550 x375x375
GD200A-022G/030P-4	22/30	56/56	45/60		
GD200A-030G/037P-4	30/37	70/80	60/75	32kg	695 x410x470
GD200A-037G/045P-4	37/45	80/94	75/92		
GD200A-045G/055P-4	45/55	94/128	92/115	67kg	760 x445 x580
GD200A-055G/075P-4	55/75	128/160	115/150		
GD200A-075G/090P-4	75/90	160/190	150/180	110kg	971 x631 x565
GD200A-090G/110P-4	90/110	190/225	180/215		
GD200A-110G/132P-4	110/132	225/265	215/260	165kg	1086x826x595
GD200A-132G/160P-4	132/160	265/310	260/305		
GD200A-160G/200P-4	160/200	310/385	305/380	450kg	1850x840x820
GD200A-200G/220P-4	200/220	385/430	380/425		
GD200A-220G/250P-4	220/250	430/485	425/480	450kg	1850x840x820
GD200A-250G/280P-4	250/280	485/545	480/530		
GD200A-280G/315P-4	280/315	545/610	530/600	450kg	1850x840x820
GD200A-315G/350P-4	315/350	610/625	600/650		
GD200A-350G/400P-4	350/400	625/715	650/720	450kg	1850x840x820
GD200A-400G-4	400	715	720		
GD200A-500G-4	500	890	860	450kg	1850x840x820

Remarks:

- (1)The input current of the inverter 0.75G-315G/350P is tested when the input voltage is 380V and there is no DC reactor and output/input reactor.
- (2)The current of the inverter 350G/400P-500G is tested when the input voltage is 380V and there is input reactor.
- (3)Rated output current is defined when the rated output voltage is 380V.

# Installation Dimension

## Installation dimension when wall mounting

Installation dimension (unit: mm)

Model		W1	W2	H1	H2	D1	Installation holes
3-phase 220VAC Series	0.75kW~2.2kW	146	131	256	243.5	181	6
	4kW~7.5kW	170	151	320	303.5	216	6
	11kW~15kW	255	237	407	384	245	7
	18.5kW ~30kW	270	130	555	540	325	7
	37kW~55kW	325	200	680	661	365	9.5
3-phase 380VAC Series	0.75kW~2.2kW	126	115	186	175	174.5	5
	4kW~5.5kW	146	131	256	243.5	181	6
	7.5kW~15kW	170	151	320	303.5	216	6
	18.5kW	230	210	342	311	216	6
	22kW~30kW	255	237	407	384	245	7
	37kW~55kW	270	130	555	540	325	7
	75kW~110kW	325	200	680	661	365	9.5
	132kW~200kW	500	180	870	850	360	11
220kW~315kW	680	230	960	926	379.5	13	

## Installation dimension when flange mounting

Installation dimension (unit: mm)

Inverter model		W1	W1	W3	W4	H1	H2	H3	H4	D1	D2	Installation holes
3-phase 220VAC series	0.75kW~2.2kW	170.2	131	150	9.5	292	276	260	6	167	84.5	6
	4kW~7.5kW	191.2	151	174	11.5	370	351	324	15	196.3	113	6
	11kW~15kW	275	237	259	11	445	426	404	10	245	119	7
	18.5kW ~30kW	270	130	261	11	445	426	404	10	245	119	7
	37kW~55kW	325	200	317	58.5	680	661	626	23	363	182	9.5
3-phase 380VAC series	0.75kW~2.2kW	150.2	115	130	7.5	234	220	190	13.5	155	65.5	5
	4kW~5.5kW	170.2	131	150	9.5	292	276	260	6	167	84.5	6
	7.5kW~15kW	191.2	151	174	11.5	370	351	324	15	196.3	113	6
	18.5kW	250	210	234	12	375	356	334	10	216	108	6
	22kW~30kW	275	237	259	11	445	426	404	10	245	119	7
	37kW~55kW	270	130	261	11	445	426	404	10	245	119	7
	75kW~110kW	325	200	317	58.5	680	661	626	23	363	182	9.5
	132kW~200kW	500	180	480	60	870	850	796	37	358	178.5	11

## Installation dimension when floor mounting

Installation dimension (unit: mm)

Inverter model	W1	W1	W3	W4	H1	H2	D1	D2	Installation holes
220kW~315W	750	230	714	680	1410	1390	380	150	13\12
350kW~500kW	620	230	553	-	1700	1678	560	240	22\12

# Installation Diagram

- 3-phase 220VAC Series  
Wall Mounting for 0.75-55kW Inverters

0.75-7.5kW Installation diagram

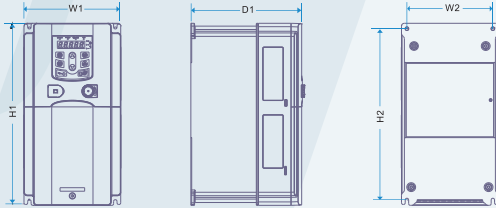

11-15kW Installation diagram

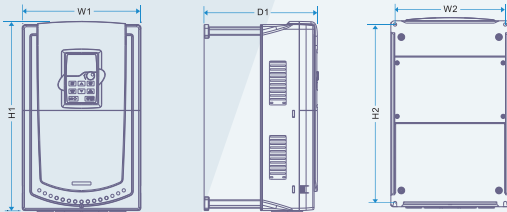

18-55kW Installation diagram

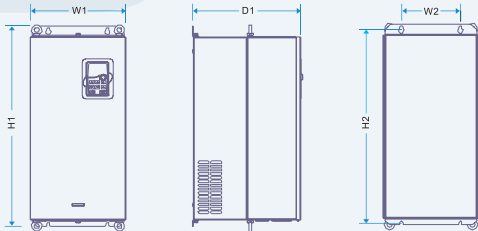

- 3-phase 380VAC Series  
Wall Mounting for 0.75-315kW Inverters

0.75-15kW Wall mounting Installation diagram

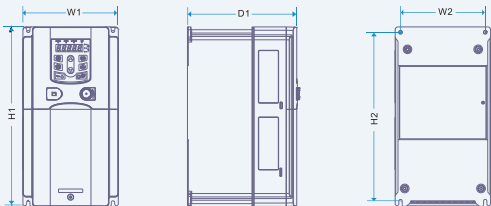

18.5-30kW Wall mounting Installation diagram

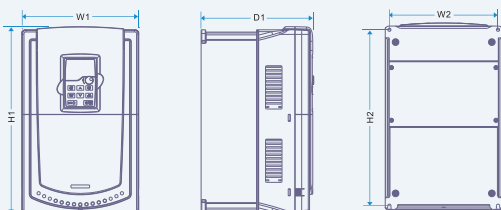

37-110kW Wall mounting Installation diagram

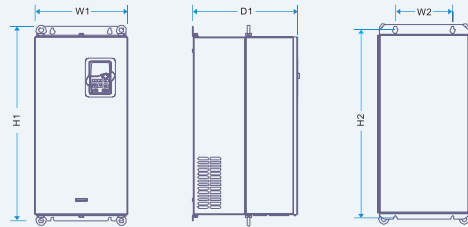

132-200kW Wall mounting Installation diagram

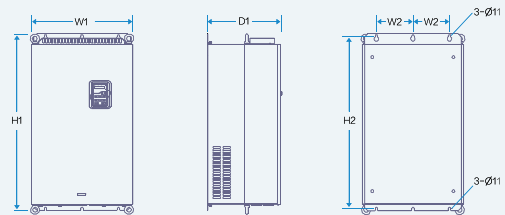

220-350kW Wall mounting Installation diagram

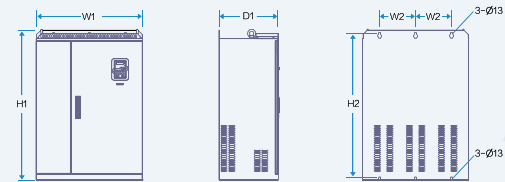

- 3-phase 220VAC Series  
Flange Mounting for 0.75-55kW Inverters

0.75-7.5kW Flange mounting installation diagram

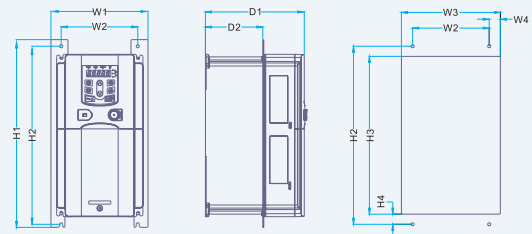

11-15kW Flange mounting installation diagram

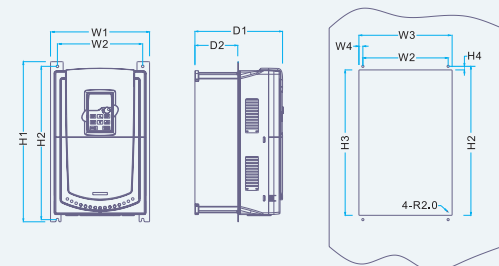

### 18-55kW Flange mounting installation diagram

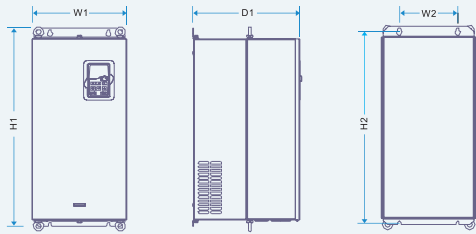

- 3-phase 380VAC Series  
Flange Mounting for 0.75-200kW Inverters

### 0.75-15kW Flange mounting Installation diagram

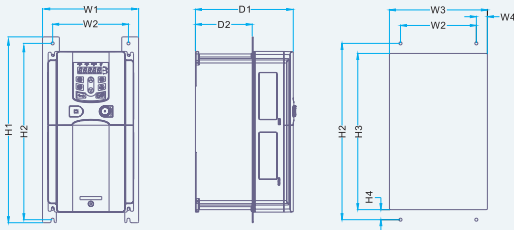

### 18.5-30kW Flange mounting Installation diagram

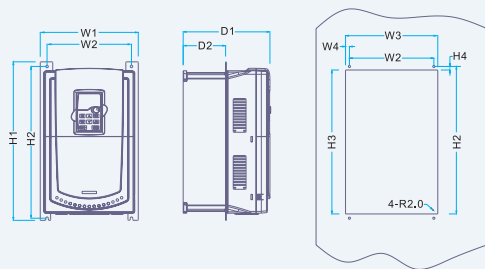

### 37-110kW Flange mounting Installation diagram

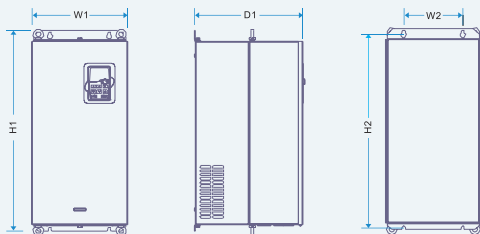

### 132-200kW Flange mounting Installation diagram

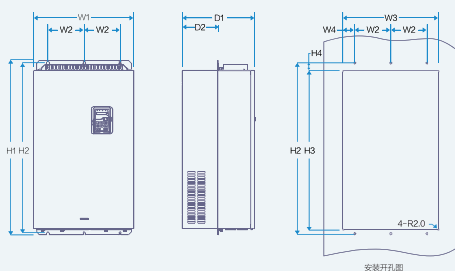

- Floor Mounting for 200-500kW Inverters

### 220-315kW Floor mounting Installation diagram

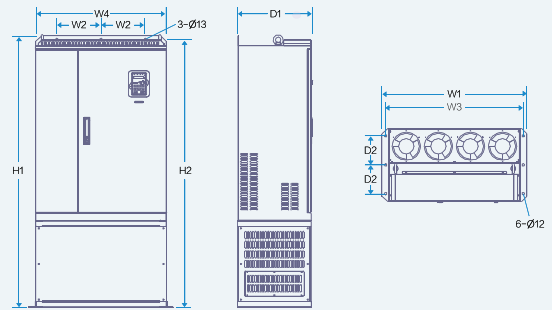

### 350-500kW Floor mounting Installation diagram

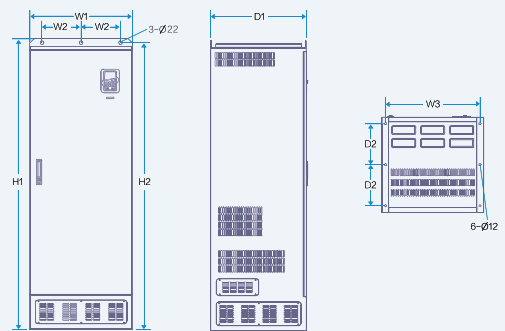

- Dimension for Keyboard

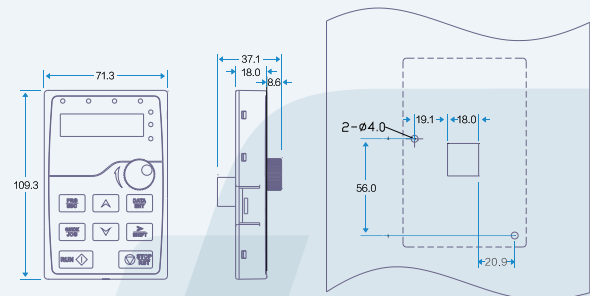

# Optional Parts

- Flange Mounting Panel

Needed for 0.75G-30G//37P inverters.  
Not needed for 37G/40P-200G//220P inverters.

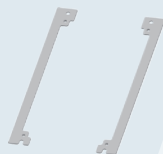

- Installation bracket for the keypad

Installation bracket or M3 screw can be used in the installation of external keypad.  
The bracket of 0.75G-30G//37P inverters is standard.  
The bracket of 37G/40P-500G inverters is optional

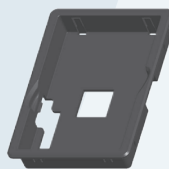

- LCD keypad

10 rows of DH displaying  
Compatible with the LED keypad



- Installation Base

Only optional in 220G/250P-315G/350P inverters .Its bases can be built in an input AC (or DC) reactor or an output AC reactor

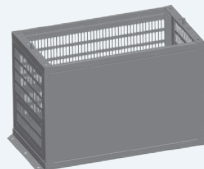

- Heat-releasing Hole

Inverter needs to derate when selecting a cover Consult with the INVT technicians for the detailed information.

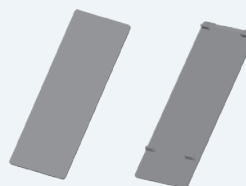

- AC single-phase 220V input auxiliary power supply

For more convenient debugging

- Filters

Inverter model		input filter	output filter
GD200A 3-phase 380VAC Series	G:0.7—2.2KW	FLT-P04006L-B	FLT-L04006L-B
	G:4—5.5KW P:5.5—7.5KW	FLT-P04016L-B	FLT-L04016L-B
	G:7.5—11KW P:11—15KW	FLT-P04032L-B	FLT-L04032L-B
	G:15—18KW P:18—22KW	FLT-P04045L-B	FLT-L04045L-B
	G:22—30KW P:30—37KW	FLT-P04065L-B	FLT-L04065L-B
	G:37—45KW P:45—55KW	FLT-P04100L-B	FLT-L04100L-B
	G:55—75KW P:75—90KW	FLT-P04150L-B	FLT-L04150L-B
	G:90KW P:110KW	FLT-P04200L-B	FLT-L04200L-B
	G:110—132KW P:132—160KW	FLT-P04250L-B	FLT-L04250L-B
	G:160—200KW P:185—220KW	FLT-P04400L-B	FLT-L04400L-B
	G:220—280KW P:250—315KW	FLT-P04600L-B	FLT-L04600L-B
	G:315—400KW P:350—400KW	FLT-P04800L-B	FLT-L04800L-B
	G:500KW	FLT-P041000L-B	FLT-L041000L-B

Remarks: C2 standard can be achieved of select above external filters



## • Reactor

The inverters of 37G/45P and above can be connected with external DC reactor. The reactor can improve the power factor and avoid damage to the rectifier bridge caused by overcurrent and damage to the rectifier circuit by harmonic

Inverter model	Input reactor	DC reactor	Output reactor
GD200A-0R7G-4	ACL2-1R5-4	/	OCL2-1R5-4
GD200A-1R5G-4	ACL2-1R5-4	/	OCL2-1R5-4
GD200A-2R2G-4	ACL2-2R2-4	/	OCL2-2R2-4
GD200A-004G/5R5P-4	ACL2-004-4	/	OCL2-004-4
GD200A-5R5G/7R5P-4	ACL2-5R5-4	/	OCL2-5R5-4
GD200A-7R5G/011P-4	ACL2-7R5-4	/	OCL2-7R5-4
GD200A-011G/015P-4	ACL2-011-4	/	OCL2-011-4
GD200A-015G/018P-4	ACL2-015-4	/	OCL2-015-4
GD200A-018G/022P-4	ACL2-018-4	/	OCL2-018-4
GD200A-022G/030P-4	ACL2-022-4	/	OCL2-022-4
GD200A-030G/037P-4	ACL2-030-4	/	OCL2-030-4
GD200A-037G/045P-4	ACL2-037-4	DCL2-037-4	OCL2-037-4
GD200A-045G/055P-4	ACL2-045-4	DCL2-045-4	OCL2-045-4
GD200A-055G/075P-4	ACL2-055-4	DCL2-055-4	OCL2-055-4
GD200A-075G/090P-4	ACL2-075-4	DCL2-075-4	OCL2-075-4
GD200A-090G/110P-4	ACL2-090-4	DCL2-090-4	OCL2-090-4
GD200A-110G/132P-4	ACL2-110-4	DCL2-110-4	OCL2-110-4
GD200A-132G/160P-4	ACL2-132-4	DCL2-132-4	OCL2-132-4
GD200A-160G/185P-4	ACL2-160-4	DCL2-160-4	OCL2-160-4
GD200A-185G/200P-4	ACL2-200-4	DCL2-200-4	OCL2-200-4
GD200A-200G/220P-4	ACL2-200-4	DCL2-200-4	OCL2-200-4
GD200A-220G/250P-4	ACL2-250-4	DCL2-250-4	OCL2-250-4
GD200A-250G/280P-4	ACL2-250-4	DCL2-250-4	OCL2-250-4
GD200A-280G/315P-4	ACL2-280-4	DCL2-280-4	OCL2-280-4
GD200A-315G/350P-4	ACL2-315-4	DCL2-315-4	OCL2-315-4
GD200A-350G/400P-4	standard configuration	DCL2-350-4	OCL2-350-4
GD200A-400G-4	standard configuration	DCL2-400-4	OCL2-400-4
GD200A-500G-4	standard configuration	DCL2-500-4	OCL2-500-4

## • Braking system

The power of 30G/37P(including) for GD200A inverters built-in braking unit, and 37G/45P(including) inverters need external braking unit; please choosing the resistor and power of braking resistor for site situation(require of braking torque and amount).

Braking resistor can increase braking torque of inverter , In the table it designs the resistor power according to 100%braking torque,10%braking count,50% braking count,80% braking count; and customers can choose braking system according to specific process and work condition.

Inverter model	braking unit model	100%braking torque fit braking resisters( $\Omega$ )	power of braking resister(kW) (10% braking count)	power of braking resister(kW) (50% braking count)	power of braking resister(kW) (80% braking count)	allowing minimum braking resister( $\Omega$ )
GD200A-0R7G-4	built-in braking unit	653	0.1	0.6	0.9	240
GD200A-1R5G-4		326	0.23	1.1	1.8	170
GD200A-2R2G-4		222	0.33	1.7	2.6	130
GD200A-004G/5R5P-4		122	0.6	3	4.8	80
GD200A-5R5G/7R5P-4		89	0.75	4.1	6.6	60
GD200A-7R5G/011P-4		65	1.1	5.6	9	47
GD200A-011G/015P-4		44	1.7	8.3	13.2	31
GD200A-015G/018P-4		32	2	11	18	23
GD200A-018G/022P-4		27	3	14	22	19
GD200A-022G/030P-4		22	3	17	26	17
GD200A-030G/037P-4		16	5	23	36	17
GD200A-037G/045P-4		DBU100H-060-4	13	6	28	44
GD200A-045G/055P-4	DBU100H-110-4	10	7	34	54	6.4
GD200A-055G/075P-4		8	8	41	66	
GD200A-075G/090P-4		6.5	11	56	90	
GD200A-090G/110P-4	DBU100H-160-4	5.4	14	68	108	4.4
GD200A-110G/132P-4		4.5	17	83	132	
GD200A-132G/160P-4	DBU100H-220-4	3.7	20	99	158	3.2
GD200A-160G/185P-4	DBU100H-320-4	3.1	24	120	192	2.2
GD200A-185G/200P-4		2.8	28	139	222	
GD200A-200G/220P-4		2.5	30	150	240	
GD200A-220G/250P-4	DBU100H-400-4	2.2	33	165	264	1.8
GD200A-250G/280P-4		2.0	38	188	300	
GD200A-280G/315P-4	Two DBU100H-320-4	3.6*2	21*2	105*2	168*2	2.2*2
GD200A-315G/350P-4		3.2*2	24*2	118*2	189*2	
GD200A-350G/400P-4		2.8*2	27*2	132*2	210*2	
GD200A-400G-4	Two DBU100H-400-4	2.4*2	30*2	150*2	240*2	1.8*2
GD200A-500G-4		2*2	38*2	186*2	300*2	

# / Sales Network



- INVT Sales & Service in 9 countries: Russia, India, Thailand, UAE, Italy, UK, Germany, Australia, Mexico
- Sales and Service Partners in 57 countries



*Your Trusted Industry Automation Solution Provider*



Service line:86-755-86312859 E-mail:overseas@invt.com.cn

**SHENZHEN INVT ELECTRIC CO., LTD.**

No.4 Building, Gaofa Scientific Industrial Park, Longjing, Nanshan District, Shenzhen, China

- |                               |  |                                       |                            |                                   |
|-------------------------------|--|---------------------------------------|----------------------------|-----------------------------------|
| <b>Industrial Automation:</b> | • Frequency Inverter                         | • Servo & Motion Control              | • Motor & Electric Spindle | • PLC                             |
|                               | • HMI  | • Intelligent Elevator Control System | • Traction Drive           |                                   |
| <b>Electric Power:</b>        | • SVG  | • Solar Inverter                      | • UPS                      | • Online Energy Management System |
|                               | • New Energy Vehicle Electric Control System |                                       |                            |                                   |

INVT Copyright.  
Information may be subject to change without notice during product improving.

Y5/1-07V1.0