

PRODUCT OF
THAILAND

LWN
OFFROAD 4X4



LWN
OFFROAD 4X4

LWN OFF ROAD CO.,LTD.

100/2 M.1 T.Yokkrabat, Ban Phaeo,
Samutsakhon 74120 Thailand

Tel: +6634-480764 Fax: +6634-481083
WWW.LWN4x4.COM Line: @LWN4x4

Facebook: LWN4x4offroad IG: lwn4x4thailand
LWN4x4 Official

FOR EXPORT

Email: wipawee.lwn@gmail.com
lwn_export@hotmail.com

Tel: +6681-3784950
Line ID: bow_wipawee
WeChat: bow5611152
WhatsApp: +6681 3784950

THE QUALITY OFF ROAD ACCESSORIES



WWW.LWN4x4.COM

LWN OFF ROAD CO., LTD.

- Manufacturer in Thailand, established since 1989
- Experience over 30 years in car accessories, automobile produces

One stop production process in ours Manufacturer

- 3D design - 3D Scanning
 - Laser cutting
 - Folding - Bending - Welding
 - Rust chemical cleansing - Powder coat painting
 - CNC mold making
 - Plastic injection
 - Packing and container loading
- Produce under brand "LWN4x4" and we also do "OEM Customer Brand"
 - Exporting to many countries for example, Japan, Malaysia, New Zealand, South Africa, Taiwan, Cambodia, Philippines and etc. We do export ourself and also through treading companies and spare part manufacturers.

LWN PRODUCT LINES INCLUDING

Car Accessories product line:

- OFF ROAD Accessories:

Bullbar, Front Bar, Rear Bumper,
Rollbar, Side Step Roof Rack, Rear Ladder, and Towbar

- General Accessories:

Stainless bumper, Aluminum Side Step, Aluminum Roof Rack
Car floor Mat injection
Seater for Pick Up car Smart Cab

Plastic Products Line: box, crate, table, chair and etc

CONTENT

BULLBAR / FRONT BUMPER

| | |
|--------|----|
| FB-014 | 5 |
| FB-016 | 7 |
| FB-001 | 9 |
| FB-003 | 10 |
| FB-009 | 11 |
| FB-012 | 12 |

FRONT BAR / REAR BAR FOR SUV

| | |
|----------------|----|
| B-BAR | 13 |
| T-BAR | 14 |
| FB-007 / A-BAR | 15 |

REAR BUMPER

| | |
|------------------|----|
| RB-013 | 16 |
| RB-014 | 17 |
| RB-016 | 18 |
| RB-017 | 19 |
| RB-004 / RB-003P | 20 |

| | |
|------------------------------------|----|
| TOWBAR | 21 |
| TOW HITCH | 22 |
| SKID PALTE FOR UNDER PROTECION | 22 |
| ROLLBAR | 23 |
| SIDE STEP | 25 |
| SUZUKI JIMNY ACCESSORIES | 26 |
| TOYOTA PRADO 150/LC300 ACCESSORIES | 27 |
| TOYOTA RAV4 ACCESSORIES | 28 |
| CAR FLOOR MAT | 29 |
| DOOR VISOR | 30 |

LWN
OFFROAD 4X4

FB-014

- 3 mm. Steel Plate ●
- Black Powder Coated Paint ●



COVER PLATE

can be opened for Sonar Box and Camera

FRONT BUMPER

LWN4X4 CAR ACCESSORIES



FB-001



FB-003



FB-009



FB-012



B-BAR



T-BAR



FB-007



A-BAR



FB-016

Yellow Original Color
[Can be detached for other colors]



SIDE STEPS

LASER CUTTING
Folding match to the car



RB-013

• REAR TOW RAPTOR STYLE

REAR BUMPER

LWN4X4 CAR ACCESSORIES



RB-014
Steel Bracket 8 mm.
Towing Ford Raptor Style



RB-016
Steel Bracket 8 mm.
Towing Ford Raptor Style



RB-017
Steel Bracket 8 mm.
Towing Ford Raptor Style



RB-004
Steel Bracket 8 mm.
63.5 mm Steel Pipe for Side Protection



RB-003P
Steel Bracket 8 mm.
63.5 mm Steel Pipe for Side Protection



TB-001
Steel Bracket 8 mm.
Square Pipe 4.5 mm.



RO-018

RO-019

CARGO LAMP / BRAKE LAMP
HIGH QUALITY
LAMP FROM TAIWAN

ROLLBAR

Strong Structure to Support Heavy-Duty Use

BE ABLE TO ADJUST THE WIDTH
to Fit Various Models

Black Powder Coated Paint

BULLBAR

FB-014

- 3 mm. Steel Plate
- Black Powder Coated Paint



3 mm. Steel Plate



Winch Compatible



Supports Sonar Box and Camera



COVER PLATE

Can be opened for Sonar Box and Camera



SKID PLATE

For Under Protection



FOG LIGHTS

Position Lamps



SENSORS

Supports All Factory Sensors



Winch

Compatible



3 mm. Steel Plate



Winch Compatible



Supports Sonar Box and Camera



FB-014

- 3 mm. Steel Plate
- Black Powder Coated Paint



AVAILABLE FOR

FORD

Ford Ranger 2015 - 2021
Ford Ranger Next Gen 2022+

ISUZU

D-Max 2020+

TOYOTA

Hilux Vigo Champ 2012 - 2015
Hilux Revo 2015 - 2017
Hilux Revo Rocco 2018 - 2019
Hilux Revo 2020+
Fortuner 2015 - 2019

NISSAN

Navara 2021
Navara NP300

BULLBAR

FB-016

- 3 mm. Steel Plate
- Black Powder Coated Paint
- Winch Compatible



FOG LIGHTS



For Anchor Shackle



SENSORS
Supports All Factory Sensors



Detachable Bar



SKID PLATE
Under Protection Plates



COVER PLATE
Can be opened for Sonar Box and Camera



Yellow Original Color
[Can be detached to do other colors]

MITSUBISHI

Triton 2019-2023



BULLBAR

FB-016



ISUZU
D-Max 2020+



NISSAN
Navara NP300
Navara 2021+



TOYOTA
Hilux Revo Rocco 2018 - 2019
Hilux Revo 2020+



FORD
Ranger 2015 - 2021

THE QUALITY OFF ROAD ACCESSORIES



3 mm. Steel Plate ●
Black Powder Coated Paint ●

BULLBAR

FB-001



3 mm. Steel Plate



Winch Compatible

FOG LIGHTS
Indicators
Position Lights



HIGH LIFT JACK
Compatible



BULLBAR UNDER
Protection Plates



3 Pcs Skid Plate



Winch Compatible



BULLBAR

FB-003

3 mm. Steel Plate ●
Black Powder Coated Paint ●



3 mm. Steel Plate



Winch Compatible

BULLBAR

FB-001 | FB-003

TOYOTA

Tiger D4D
Hilux Vigo 2005
Hilux Vigo Champ
Hilux Revo 2015-2017
Hilux Revo Rocco 2017-2019
Hilux Revo S/C 2015-2017
Hilux Revo 2020+
Hilux Revo S/C 2020+
LC78
LC80 / Vx80

MITSUBISHI

Triton 2005-2014
Triton 2015-2018
Triton 2019+

MAZDA

Bt50 Pro 2012-2019

FORD

Ford Ranger 2009
Ford Ranger 2012-2014
Ford Ranger 2015-2021

NISSAN

Frontier
Navara D40
Navara NP300
Navara 2021+

ISUZU

D-Max 2012-2014
D-Max 2015-2019
D-Max 2020+



TOYOTA | LC80

- 3 mm. Steel Plate
- Black Powder Coated Paint



3 mm. Steel Plate



Winch Compatible

BULLBAR BULLBAR

FB-012 | **FB-009**



3 Pcs Skid Plate



Winch Compatible



3 mm. Steel Plate



Winch Compatible

DETAILS

FB-009 | FB-012

- 3 mm. Steel Plate
- Black Powder Coated Paint
- Winch Compatible
- Supports All Factory Sensors
- Fog Lights and Position Lights
- Skid Plate for Under Protection

TOYOTA

Hilux Vigo 2005
Hilux Vigo Champ
Hilux Revo 2015-2017
Hilux Revo Rocco 2018-2019

ISUZU

D-Max 2012-2014
D-Max 2015-2019

SUZUKI

Jimny Sierra JB74
Jimny JB64

FORD

Ford Ranger 2012-2014
Ford Ranger 2015-2021
Ford Raptor
Ford Ranger Next Gen

MITSUBISHI

Triton 2015-2018
Triton 2019-2023

NISSAN

Navara NP300



TWO-TONE
BLACK SILVER

B-BAR

TOYOTA

Hilux Vigo 2005-2014
Hilux Revo 2015-2022
Fortuner 2005-2014
Fortuner 2015-2022
Harrier
Prado 150
Rav4

FORD

Ford Ranger 2012-2021
Ford Ranger Next Gen 2022+
Ford Everest 2015-2021
Ford Everest Nex Gen 2022+

MITSUBISHI

Triton 2015-2023
Triton 2024
Pajero 2015-2019
Pajero 2020+
Delica D5

NISSAN

Navara NP300
Navara 2021+

ISUZU

D-Max 2012-2019
D-Max 2020-2022
Mu-X 2012-2019
Mu-X 2021+



- Two-Tone Color (Black Powder Coated Paint)
- Steel Bracket 6mm. - 8mm.
- 63.5 mm. Pipe /Thickness 2mm. for Side Protection
- Supports All Factory Sensors



T-BAR

MITSUBISHI TOYOTA

Pajero 2015-2019
Pajero 2020+

New Fortuner 2015-2022
Rav4

ISUZU

Mu-x 2012-2019
Mu-x 2021+

FORD

Ford Everest 2015-2021
Ford Everest Next Gen 2022+



● **T-BAR | V.2**

Supports Towing and Hitch Ball



A-BAR



3 Inch Pipe / Thickness 1.5 mm.
Bracket Steel 6 mm.
Black Powder Coated Paint
Detachable Licence Plate



AVAILABLE FOR

MITSUBISHI
Pajero 2007-2014
Pajero 2015-2019

FORD
Ford Ranger 2012-2021
Ford Everest 2015-2021

NISSAN
Navara NP300
Navara 2021+

ISUZU
D-Max 2020+
Mu-X 2021+

TOYOTA
Hilux Vigo
Hilux Revo
Fortuner 2005-2014
Fortuner 2015+

LWN4X4 CAR ACCESSORIES



FB-007

4 mm. Steel with Square Pipe Under
Bracket Steel 8 mm.
Black Powder Coated Paint
Winch Compatible



AVAILABLE FOR

MITSUBISHI
Triton 2007-2014
Triton 2015-2018
Triton 2019-2023
Pajero Sport 2007-2014

ISUZU
D-Max 2012-2019
D-Max 2020+
Mu-X 2012-2019
Mu-X 2021+

TOYOTA
Hilux Vigo
Hilux Revo
Fortuner 2005-2014
Fortuner 2015-2023

FORD
Ford Ranger 2012-2021
Ford Everest 2015-2021

NISSAN
Navara NP300
Navara 2021+

RB-013



REAR BUMPER

AVAILABLE FOR

TOYOTA
Hilux Vigo
Hilux Revo

FORD
Ford Ranger 2012-2021
Ford Raptor
Ford Ranger Next Gen 2022+
Mazda BT50 Pro 2012-2019

NISSAN
Navara NP300
Navara 2021

MITSUBISHI
Triton 2015-2018
Triton 2019-2023
Triton 2024

ISUZU
D-Max 2012-2019
Colorado 2012-2019
D-Max 2020+



Steel Bracket 8 mm.
Square Pipe 4.5 mm. Support Towing
Supports All Factory Sensors
Supports Sonar Box
Black Powder Coated Paint
Towing Ford Raptor Style

REAR TOW RAPTOR STYLE



Support Installing Sonar Boxes
(Plastic Cover+Bracket Sonar)

SPECIAL DESIGN FOR SUPPORTING SONAR BOXES

AVAILABLE FOR
Toyota Hilux Revo
Mitsubishi Triton 2019-2023
Mitsubishi Triton 2024
Isuzu D-Max 2020+
Nissan Navara 2021+



FORD
Ford Ranger, Next Gen

Supports All Factory Sensors

RB-014

DETAILS

RB-014 | RB-016



REAR TOW
RAPTOR STYLE

- Steel Bracket 8 mm.
- Square Pipe 4.5 mm. Support Towing
- 63.5 mm Steel Pipe for Side Protection
- Supports All Factory Sensors
- Black Powder Coated Paint
- Hi-Lift Jacking Points + Towing Point
- Towing Ford Raptor Style



ISUZU

D-Max 2012-2019
Colorado 2012-2020
D-Max 2020+

FORD | MAZDA

Ford Ranger 2012-2021
Mazda BT50 Pro 2012-2020

TOYOTA

Hilux Vigo 2005-2014
Hilux Revo 2015-2022

MITSUBISHI

Triton 2019-2023

NISSAN

Navara NP300 /Navara 2021+



REAR TOW
RAPTOR STYLE

RB-016

ISUZU

D-Max 2012-2019
Colorado 2012-2020
D-Max 2020+

FORD | MAZDA

Ford Ranger 2012-2021
Ford Ranger Next Gen 2022+
Mazda BT50 Pro 2012-2020

TOYOTA

Hilux Vigo 2005-2014
Hilux Revo 2015-2022

MITSUBISHI

Triton 2019-2023

NISSAN

Navara NP300 /Navara 2021



LED
SPOTLIGHT

ALUMINUM PLATE

REAR BUMPER

- Square Pipe 4.5 mm. Support Towing
- Hi-Lift Jacking Points + Towing Point



Black Powder Coated Paint



SUPPORT ALL FACTORY SENSORS



BRACKET STEEL 8 mm.

RB-017



AVAILABLE FOR

MITSUBISHI

Triton 2019-2023

FORD

Ford Ranger 2012-2021
Mazda BT50 Pro 2012-2019

TOYOTA

Hilux Vigo
Hilux Revo

ISUZU

D-Max 2020+

RB-004



AVAILABLE FOR

ISUZU

D-Max 2007
D-Max 2012-2019
Colorado 2012-2020
D-Max 2020+

MITSUBISHI

Triton 2007-2018
Triton 2019-2023

NISSAN

Navara D40
Navara NP300
Navara 2021

TOYOTA

Hilux Vigo
Hilux Revo

FORD

Ford Ranger 2012-2021
Mazda BT50 Pro 2012-2019



TOWBAR

TB-001

TOWBAR DOUBLE HITCH BALL



TOWBAR TOW HITCH



- FORD**
 Ford 2007-2011
 Ford Ranger 2012-2021
 Ford Ranger Next Gen 2022+
 Ford Everest 2015-2021
 Ford Everest 2022+
 Ford Raptor 2018-2021
 Ford Raptor Next Gen

- CHEVROLET**
 Trailblazer
 Colorado 2012-2021

- MG**
 MG Extender

- MAZDA**
 Mazda 2007-2011
 Mazda BT50 Pro 2012-2020
 Mazda BT50 2021+

- NISSAN**
 Navara D40
 Navara NP300
 Navara 2021
 Urvan
 X-trail

- ISUZU**
 D-Max 2007-2011
 D-Max 2012-2019
 D-Max 2020+ 4D
 D-Max 2020+ S/C
 Mu7
 Mu-X 2012-2019
 Mu-X 2020+

- TOYOTA**
 Hilux Vigo 2005-2014
 Hilux Revo 2015-2021
 Fortuner 2005-2014
 Fortuner 2015+
 Raize
 Hiace
 Probox
 Land Cruiser (vx-80)

- MITSUBISHI**
 Triton 2007-2023
 Triton 2024
 Pajero 2007-2019
 Pajero 2020+
 Delica D5



DETAILS | TB-001

- Square pipe size: 3x3" Thickness 4.5 mm.
- Bracket Thickness: 8 mm.
- Black Powder Coated Paint
- Ball size : 50 mm. or 2 inch
- Total weight: 25-30 kg.
- Can be installed under original bumper
- No need to cut any part of car, just use bolt to install

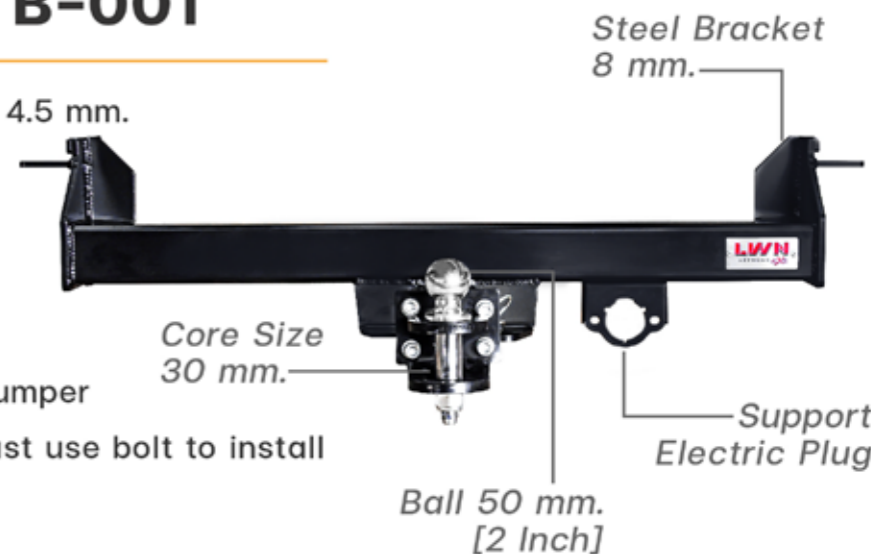

TOW HITCH

ACCESSORIES

Double Hitch Ball



Tow Hitch



Connected Steel



Pitle hook+Ball



Tow Hitch [Size A0-A9]



Height Adjustable Tow Hitch



Safety Lock Tow Hitch



SKID PLATE

FOR UNDER PROTECTION 3 mm Steel Plate

HILUX REVO



D-MAX 2021+



NAVARA NP300



FORD RANGER NEXT GEN



FORD RANGER 2012-2021



TRITON 2015-2023

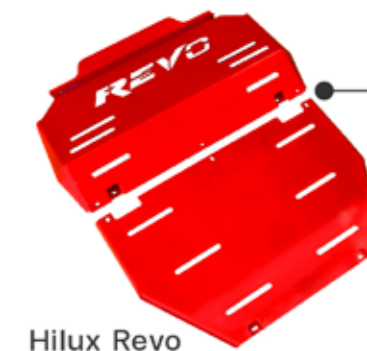

Hilux Revo

Skip Plate 2 Pcs [Double Under Protection]



BE ABLE TO ADJUST THE WIDTH
to Fit Various Models

HIGH QUALITY
76.2 mm Steel Pipe

ROLLBAR RO-018

PLASTIC INJECTION PART
For Modern Design



CARGO LAMP | BRAKE LAMP
HIGH QUALITY
LAMP FROM TAIWAN

BE ABLE TO ADJUST THE WIDTH
to Fit Various Models



RED LOGO
Laser Cutting
Match to the Rollbar's design

ROLLBAR RO-019

ROLLBAR

LWN4X4 CAR ACCESSORIES

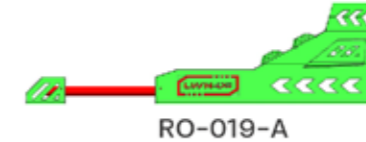

/ CAR MODEL
Mitsubishi Triton 2015-2023

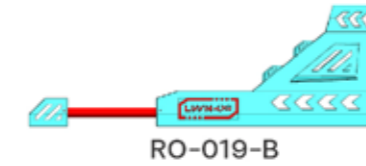
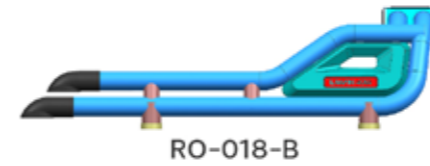

/ CAR MODEL
Toyota Hilux Revo
Isuzu D-Max 2020+
Ford Ranger 2012-2021
Mitsubishi Triton 2024
Nissan Navara NP300
Nissan Navara 2021+
Ford Ranger Next Gen 2022+

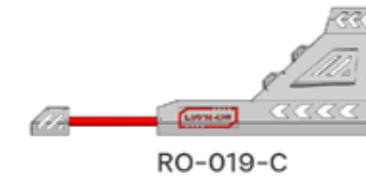
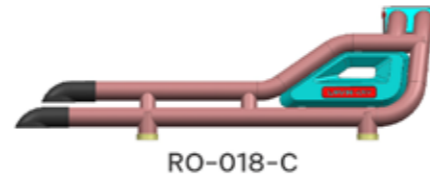

/ CAR MODEL
Toyota Hilux Vigo
Chevrolet Colorado 2012-2019
Isuzu D-Max 2012-2019



DETAILS RO-018 | RO-019

- High Quality Steel Plate
- Black Powder Coated Paint
- Strong Structure to Support Heavy-Duty Use
- 3 Models [A, B, C] Pipe is Adjustable to Fit Various Models



RO-011-A
Ford Ranger 2012-2021
Toyota Hilux Revo
Isuzu D-Max 2020+

RO-011-B
Nissan Navara NP300
Nissan Navara 2021+

RO-011-C
Mitsubishi Triton
2015-2023

RO-011-D
Isuzu D-Max 2020+



RO-012-A
Ford Ranger 2012-2021
Toyota Hilux Revo
Isuzu D-Max 2020+

RO-012-B
Mitsubishi Triton
2015-2023



RO-013-A
Toyota Hilux Revo

RO-013-B
Nissan Navara NP300
Nissan Navara 2021+

DETAILS RO-011 / RO-012 / RO-013

- Black Powder Coated Paint
- High Quality 76.2 mm Steel Pipe
- Strong Structure to Support Heavy-Duty Use

SIDE STEPS

SS-015

DETAILS

- Black Powder Coated Paint
- Bracket Steel
- Perfectly Fit to the Car

Available For

MAZDA

Mazda BT50 Pro 2012-2020
Mazda BT50 2021+

FORD

Ford Ranger 2012-2021
Ford Ranger Next Gen 2022+

MITSUBISHI

Triton 2015-2023
Mitsubishi Triton 2024

NISSAN

Navara NP300
Navara 2021+

ISUZU

D-Max 2012-2023+
Colorado 2012-2021

TOYOTA

Hilux Vigo / Revo

LASER CUTTING
Folding match to the car

HIGH QUALITY
Steel Plate 3 mm.



Expanded Metal
SIDE STEPS
SS-001



Aluminum
SIDE STEPS
SS-002



Aluminum
SIDE STEPS
SS-003



Pumped Steel
SIDE STEPS
SS-004

LWN4X4 CAR ACCESSORIES

SIDE STEPS

SS-FREESIZE

DETAILS

SS-FREESIZE

- High Quality Aluminum with Modern Texture
- Rubber on the Aluminum prevent slipping
- Plastic Cover on Front - Rear
- Steel Bracket for Installing

FOR EVERY CAR MODEL
SIDE STEP FREESIZE



FRONT BUMPER

JB64 and JB74



FRONT BAR
A-BAR



BULLBAR
FB-009



BULLBAR
FB-012

REAR LADDER

JB64 and JB74



REAR RACK

Install with Real Ladder to carry things



REAR LADDER

Stainless Steel

SUZUKI JIMNY

JB64 and JB74

SIDE STEP

JB64 and JB74



SIDE STEPS
SS-JIMNY-3



SIDE STEPS
SS-JIMNY-2



SIDE STEPS
SS-JIMNY-1

REAR BUMPER / TOWBAR

JB64 and JB74

TOWBAR
TB-001



REAR BUMPER
RB-013



BULLBAR

FB-012



PRADO 150

B-BAR

- Steel Bracket 6mm. - 8mm.
- Two-Tone Color (Black Powder Coated Paint)
- 63.5 mm. Pipe /Thickness 2mm. for Side Protection
- Supports All Factory Sensors



SKID PLATE

PRADO 150

- High Quality Steel 3 mm.
- Red Powder Coated Paint
- Skid Plate for Under Protection



TWO-TONE
BLACK SILVER



FRONT BUMPER

RAV4



FRONT BUMPER

RAV4



B-BAR

RAV4



T-BAR-2

RAV4



A-BAR

RAV4

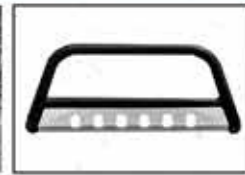

TOWBAR

RAV4



SIDE STEPS

RAV4



RAV4
SIDE STEPS



FB-017

- No need to cut original bumper
- Support all factory sensor
- Winch compatible
- 3 Pcs Skid plates



BULLBAR

LAND CRUISER 300

RAV4



**PERFECTLY
FIT TO THE CAR**

High Edge Protection
to Prevent water out the floor mat



**TOYOTA
MAJESTY (VAN)**



**TOYOTA
REVO 4 DOORS**



**MITSUBISHI
PAJERO SPORT**

CAR FLOOR MAT

- Made from Plastic Injection [EVA]
- High Edge Protection to Prevent Water Out the Floor Mat
- Perfectly Fit to the Car
- Strong and Durable
- Easy to Install and Clean



CAR FLOOR MAT

| | | | |
|---|--|--|---|
| <p>TOYOTA ALTIS 2008-2013 ALTIS 2014-2018 Vios 2007-2012 Vios - Yaris 2013-2022 Camry 2002-2006 Camry 2007-2011 Camry 2012-2018 C-HR Collora Cross Hilux Vigo Double Cab Hilux Vigo Smart Cab Hilux Revo Double Cab Hilux Revo Smart Cab Avanza 2012-2016 (SUV) Inova Cryata 2017-2023 (SUV) Sienta (SUV) Fortuner - Innova 2006-2014 (SUV) Fortuner 2015-2023 (SUV) Veloz (SUV) Commuter (VAN) 2005-2018 Commuter (VAN) 2019+ Majesty (VAN) Hiace (VAN)</p> | <p>HONDA Jazz 2008-2013 Jazz 2014-2017 Jazz 2018-2022 City 2008-2013 City 2014-2019 City 2020+ 4D City Hatchback 2021+ Accord 2012-2015 Accord 2016-2019 Accord 2020+ Brio Amaze 2013 Civic 2012-2015 Civic 2016-2020 Civic 2021+ HRV 2012-2017 HRV 2018-2021 HRV 2022+ CRV 2014-2018 CRV 2017-2021 (SUV) BRV BRV (SUV) Mobilio (SUV)</p> | <p>NISSAN Juke Almera 2012-2019 Alemra 2020+ Teana 2009-2019 Livina Navara D40 2007-2014 Smart Cab Navara D40 2007-2014 Double Cab Navara NP300 Smart Cab Navara NP300 Double Cab Navara 2021+ Smart Cab Navara 2021+ Double Cab Pulsar - Sylphy March 2010-2017 Xtali Note Urvan 2014-2020 (VAN)</p> | <p>CHEVROLET Colorado Smart Cab Colorado Double Cab Spin 2012-2018 (SUV) Cruze Sonic Captiva 2011-2014 (SUV) Trailblazer 2012-2018 (SUV) Trailblazer 2018-2021 (SUV)</p> |
| <p>MAZDA Mazda BT50 Pro 2012-2020 Smart Cab Mazda BT50 Pro 2012-2020 Double Cab Mazda BT50 2021+ Smart Cab Mazda BT50 2021+ Double Cab Mazda2 Elegance 2009-2014 Mazda2 Skyactiv 2015-2017 Mazda2 skyactiv 2018-2022 Mazda3 Skyactiv 2015-2017 Mazda3 Skyactiv 2018-2022 Mazda CX-5 2015-2017 Mazda CX-5 2018-2022 Mazda CX-3</p> | <p>SUZUKI Swift 2012-2017 Swift 2018-2023 Ertiga Celerio Ciaz XL7 New Carry 2019+</p> | <p>MITSUBISHI Attrage Mirage Triton (2005-2014) Smart Cab Triton (2005-2014) Double Cab Triton (2015-2023) Double Cab Triton (2015-2023) Smart Cab Triton 2024 Smart Cab Pajero Sport (SUV) 2008-2014 New Pajero Sport 2015+ (SUV) Xpender (SUV)</p> | <p>FORD Ford Fiesta Ford EcoSport Ford Everest 2015-2021 (SUV) Ford Everest 2022+ (SUV) Ford Focus Ford Ranger 2012-2021 Smart Cab Ford Ranger 2012-2021 Double Cab Ford Ranger Next Gen Smart Cab Ford Ranger Next Gen Double Cab</p> |
| <p>MG MG HS 2019 MG ZS 2017 MG 3 MG Extender Double Cab MG Extender Smart Cab</p> | <p>ISUZU D-Max All New 2012-2019 Smart Cab D-Max All New 2012-2019 Double Cab D-Max 2020+ Smart Cab D-Max 2020+ Double Cab MU-X (SUV) 2012-2020 MU-X 2021-2023 (SUV)</p> | <p>LEFT HAND DRIVE Hilux Revo D-Max All New 2012-2019 Triton 2015-2023 Navara NP300 Mazda BT50 Pro 2012-2019 Ford Ranger 2012-2021 Colorado 2012-2018 Fortuner 2015+ (SUV) MU-X 2012-2019 (SUV) Trailblazer 2012-2019 (SUV)</p> | |

DOOR VISOR

Made from High Quality
Plastic ABS Injection

Front Door and Rear Door Piece are designed

perfectly to close together



High Quality 3D tape



CAR DOOR VISOR

Made from Plastic Injection [ABS] •
Front Door and Rear Door Piece are Designed •
Perfectly to Close Together
Strong and Durable •

AVAILABLE FOR

| | | |
|---|--|--|
| <p>TOYOTA Hilux Revo Double Cab Hilux Revo Smart Cab Fortuner 2015+ Vios 2015-2022 Yaris 2019-2021 Yaris 2022-2024 4D Yaris Hatchback 2019+ Altis 2019-2022 CHR 2018-2022 Collora Cross Sienta Majesty 2019 Commuter 2019+</p> | <p>MAZDA Mazda BT50 2021+ Smart Cab Mazda BT50 2021+ Double Cab Mazda 2 Skyactiv 2019+ 4D/5D Mazda 3 Sky activ 2019+ 4D Mazda 3 Skyactiv 2019+ 5D</p> | <p>ISUZU D-Max 2020+ Smart cab D-Max 2020+ Double Cab Mux 2021</p> |
| <p>MITSUBISHI Attrage Mirage Xpander Pajero 2015-2022+ Triton 2019-2023 Double Cab Triton 2019-2023 Smart Cab Triton 2024 Double Cab Triton 2024 Smart Cab</p> | <p>HONDA Civic 2021 4D Civic 2021 5D Civic 2020 4D Mobilio/BRV CRV Accord 2020</p> | <p>NISSAN Navara 2014-2022 Double Cab Navara 2014-2022 Smart Cab March 2012+ Kicks 2020+ Almera 2020 Note 2017+</p> |
| <p>MG MG HS 2019+ MG ZS 2017+ MG 3</p> | <p>FORD Ford Ranger Next Gen Double Cab Ford Ranger Next Gen Smart cab</p> | |

