

**Index**

Page



ON-OFF Switches for Panel Mounting

306



ON-OFF Switches for Single Hole Mounting

307



ON-OFF Switches for Base Mounting with Door Clutch

308



ON-OFF Switches for Distribution Boards

309



Main Switches for Panel Mounting

310



Main Switches for Single Hole Mounting

311



Main Switches for Base Mounting with Door Clutch

312



Main Switches for Distribution Boards

313



Main Switches in Plastic Enclosure

314



Technical Datas  
Approvals

315

319

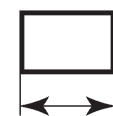

Dimensions

321

Contactors, Motor-Starter

Circuit Breakers

Manual Motor-Starters

Switches

AC-Main Switches

DC-Switch Disconnector

Push Buttons

Representatives, Suppliers

Ratings				DC-Switch Disconnectors			
Type	I <sub>th</sub> open A	DC21B(DC-PV1) at U <sub>e</sub>		Design			
		I <sub>th</sub> open A	4 poles in series V	Panel mounting 4-hole mounting IP66 <sup>1)</sup> cULus Type 3R	Single hole mounting Ø22,5mm IP66 <sup>1)</sup> cULus Type 4X	Base mounting w. door coupling IP66 <sup>1)</sup> cULus Type 4X	Modular switch IP40 <sup>1)</sup> cULus Open Type
LS16	16	16	1500	.. E ..	.. Z(O) ..	.. VZV ..	.. SMA ..
LS25	25	25	1500	.. E ..	.. Z(O) ..	.. VZV ..	.. SMA ..
LS32	32	32	1500	.. E ..	.. Z(O) ..	.. VZV ..	.. SMA ..
LS38	38	38	1500	.. E ..	.. Z(O) ..	.. VZV ..	.. SMA ..
LS40	40	40	1500	.. E ..	-	.. VZV ..	.. SMA ..
LS55	55	55	1500	.. E ..	-	.. VZV ..	.. SMA ..
LS65	65	65	1500	.. E ..	-	.. VZV ..	.. SMA ..

### Switch Disconnectors for Photovoltaic

Switch disconnectors „LS..“ are switch gears for interrupting the DC/AC-Inverter from the solar-panels. Photovoltaic-installations have to be equipped with DC-isolators according to IEC 60364-7-712.

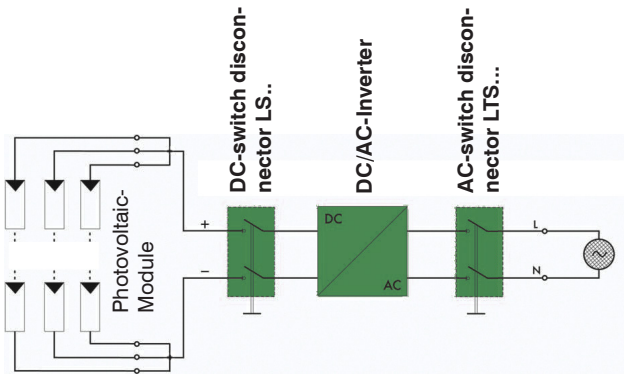

Switch disconnectors „LS..“ ensures a reliable switching up to 85A with 1500V in the category DC21B (DC-PV1).

The construction of the contacts and the material selection guarantee that no oxidation (small switching frequency) develops, and is thus prevented inadmissible heating-up.

The switch disconnector has 2, 4, 6 or 8 contacts, by serial or parallel wiring of the contacts the contact rating will be increased. The switching speed at the manually operated handle does not have an effect on the switching attitude of the contacts.

#### Mounting positions:

No limitations, all kind of positions allowed.

### Ordering

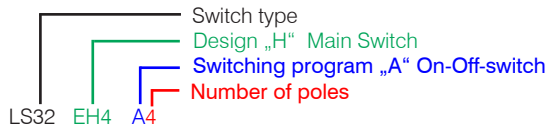

### Switching programs

Type	2-pole	2+2-pole 2 poles in series +2 poles parallel	4-pole	4-pole with jumpers Input on top Output bottom	4-pole with jumpers Input and Output bottom	4-pole with jumpers Input and Output on top
LS16 ... LS55	.. A2	.. A2+2	.. A4(2 x A2)	.. A4B	.. A4O	.. A4U
Contacts Wiring diagram						
Switching example						

1) Protection in front and built in.

## DC-Main Switches

Panel mounting  
Four-hole mounting  
IP66<sup>1)</sup> Type 3R



Single hole mounting  
Ø22,5mm IP66<sup>1)</sup> Type 4X



Base mounting  
with door coupling  
IP66<sup>1)</sup> Type 4X



Modular  
switch IP40<sup>1)</sup> Open Type



Plastic enclosed  
PFL..IP66/67 Type 4X



.. EH4. ..	.. Z(O)H1 ..	.. VZVH4 ..	.. SMAH1 ..	.. PFLH4 ..
.. EH4. ..	.. Z(O)H1 ..	.. VZVH4 ..	.. SMAH1 ..	.. PFLH4 ..
.. EH4. ..	.. Z(O)H1 ..	.. VZVH4 ..	.. SMAH1 ..	.. PFLH4 ..
.. EH4. ..	.. Z(O)H1 ..	.. VZVH4 ..	.. SMAH1 ..	.. PFLH4 ..
.. EH4. ..	-	.. VZVH4 ..	.. SMAH1 ..	.. PFLH4 ..
.. EH4. ..	-	.. VZVH4 ..	.. SMAH1 ..	.. PFLH4 ..
.. EH4. ..	-	.. VZVH4 ..	.. SMAH1 ..	.. PFLH4 ..

### Technical Data for DC, according to IEC 60947-3, VDE0660, more data find on page 315.

Type		DC-PV1 (=DC21B)							
		500V	600V	700V	800V	900V	1000V	1200V	1500V
2 Poles in series 	<b>LS16..</b> A	16	16	16	16	16	10	7	3
	<b>LS25..</b> A	25	25	25	20	17	11,5	8,5	5
	<b>LS32..</b> A	32	32	32	23	20	13	10	6
	<b>LS38..</b> A	45	45	-	30	-	20	-	-
	<b>LS40..</b> A	48	48	37	35	31	29	11	7,5
	<b>LS55..</b> A	55	55	55	55	43	36	17	10
	<b>LS65..</b> A	75	75	75	65	55	40	17	10
2 Poles in series+2 parallel 	<b>LS16..</b> A	29	29	22	17	16	10	7	3
	<b>LS25..</b> A	45	36	27	19	17	11,5	8,5	5
	<b>LS32..</b> A	58	55	32	23	20	13	10	6
	<b>LS38..</b> A	-	-	-	30	-	20	-	-
	<b>LS40..</b> A	72	68	49	42	31	29	11	7,5
	<b>LS55..</b> A	85	85	77	63	43	36	17	10
	<b>LS65..</b> A	85	85	80	65	55	40	17	10
4 Poles in series 	<b>LS16..</b> A	16	16	16	16	16	16	16	16
	<b>LS25..</b> A	25	25	25	25	25	25	25	25
	<b>LS32..</b> A	32	32	32	32	32	32	32	32
	<b>LS38..</b> A	45	45	45	45	45	38	32	32
	<b>LS40..</b> A	48	48	40	40	40	40	40	40
	<b>LS55..</b> A	55	55	55	55	55	55	55	55
	<b>LS65..</b> A	75	75	75	75	75	75	65	65
4 Poles in series+2 parallel 	<b>LS16..</b> A	29	29	29	29	29	29	29	20
	<b>LS25..</b> A	45	45	45	45	45	45	45	26
	<b>LS32..</b> A	58	58	58	58	58	58	50	32
	<b>LS38..</b> A	-	-	-	-	-	-	-	-
	<b>LS40..</b> A	72	72	72	72	72	72	56	42
	<b>LS55..</b> A	85	85	85	85	85	85	65	55
	<b>LS65..</b> A	85	85	85	85	85	85	65	55

Type	6-pole	3+2-pole 3 poles in series +2 poles parallel	8-pole	4+2-pole 4 poles in series +2 poles parallel
<b>LS16 ... LS55</b>	...A6	.. A3+2	...A8	.. A4+2
Contacts Wiring diagram				
Switching example				

Insulated jumpers LSV.. for series and parallel switching of contacts see page 325.



# ON-OFF Switches for Panel Mounting, Escutcheon plate 64<sup>o</sup>, IP66, US Type 3R



DC21B / DC-PV1 600V DC 1000V DC		Poles in series	Number of strings	Type	Pack pcs.	Weight kg/pcs.
16A	10A	2	1	<b>LS16 E A2</b>	1	0,20
25A	11,5A	2	1	<b>LS25 E A2</b>	1	0,20
32A	13A	2	1	<b>LS32 E A2</b>	1	0,20
45A	20A	2	1	<b>LS38 E A2</b>	1	0,20
48A	29A	2	1	<b>LS40 E A2</b>	1	0,41
55A	36A	2	1	<b>LS55 E A2</b>	1	0,41
65A	40A	2	1	<b>LS65 E A2</b>	1	0,41

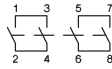

29A	10A	2	1	<b>LS16 E A2+2</b>	1	0,25
36A	11,5A	2	1	<b>LS25 E A2+2</b>	1	0,25
55A	13A	2	1	<b>LS32 E A2+2</b>	1	0,25
-	20A	2	1	<b>LS38 E A2+2</b>	1	0,25
68A	29A	2	1	<b>LS40 E A2+2</b>	1	0,54
85A	36A	2	1	<b>LS55 E A2+2</b>	1	0,54
85A	40A	2	1	<b>LS65 E A2+2</b>	1	0,54

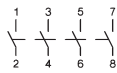

16A	10A	2	2	<b>LS16 E A4</b>	1	0,23
25A	11,5A	2	2	<b>LS25 E A4</b>	1	0,23
32A	13A	2	2	<b>LS32 E A4</b>	1	0,23
45A	20A	2	2	<b>LS38 E A4</b>	1	0,23
48A	29A	2	2	<b>LS40 E A4</b>	1	0,49
55A	36A	2	2	<b>LS55 E A4</b>	1	0,49
65A	40A	2	2	<b>LS65 E A4</b>	1	0,49

Type suffix



**B** ..A4B

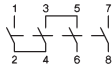

16A	16A	4	1	<b>LS16 E A4.</b>	1	0,24
25A	25A	4	1	<b>LS25 E A4.</b>	1	0,24
32A	32A	4	1	<b>LS32 E A4.</b>	1	0,24
45A	-	4	1	<b>LS38 E A4.</b>	1	0,24
48A	40A	4	1	<b>LS40 E A4.</b>	1	0,52
55A	55A	4	1	<b>LS55 E A4.</b>	1	0,52
-	-	4	1	<b>LS65 E A4.</b>	1	0,52

**O** ..A4O

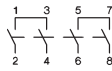

**U** ..A4U

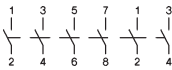
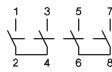

16A	10A	2	3	<b>LS16 E A6</b>	1	0,36
25A	11,5A	2	3	<b>LS25 E A6</b>	1	0,36
32A	13A	2	3	<b>LS32 E A6</b>	1	0,36
45A	20A	2	3	<b>LS38 E A6</b>	1	0,36
48A	29A	2	3	<b>LS40 E A6</b>	1	0,99
55A	36A	2	3	<b>LS55 E A6</b>	1	0,99
-	-	2	3	<b>LS65 E A6</b>	1	0,99

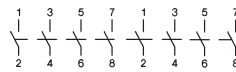

16A	10A	2	4	<b>LS16 E A8</b>	1	0,41
25A	11,5A	2	4	<b>LS25 E A8</b>	1	0,41
32A	13A	2	4	<b>LS32 E A8</b>	1	0,41
45A	20A	2	4	<b>LS38 E A8</b>	1	0,41
48A	29A	2	4	<b>LS40 E A8</b>	1	1,09
55A	36A	2	4	<b>LS55 E A8</b>	1	1,09
-	-	2	4	<b>LS65 E A8</b>	1	1,09

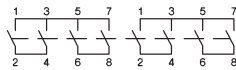

29A	29A	4	1	<b>LS16 E A4+2</b>	1	0,46
45A	45A	4	1	<b>LS25 E A4+2</b>	1	0,46
58A	58A	4	1	<b>LS32 E A4+2</b>	1	0,46
-	-	4	1	<b>LS38 E A4+2</b>	1	0,46
72A	72A	4	1	<b>LS40 E A4+2</b>	1	1,20
85A	85A	4	1	<b>LS55 E A4+2</b>	1	1,20
85A	85A	4	1	<b>LS65 E A4+2</b>	1	1,20







## Extended Switch Shaft for all switches for Panel Mounting

Type suffix

+VW"x"

x = panel thickness

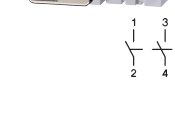
## ON-OFF Switches for Single Hole Mounting Ø22mm, Escutcheon plate 48<sup>□</sup>, IP66, c(UL)us Type 4X

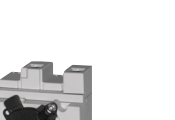
	DC21B / DC-PV1		Anzahl Pole in Serie	Anzahl Strings	Typ	VPE Stk.	Gewicht kg/Stk.
	600V DC	1000V DC					
			2	1	<b>LS16 Z A2</b>	1	0,21
	16A	10A	2	1	<b>LS25 Z A2</b>	1	0,21
	25A	11,5A	2	1	<b>LS32 Z A2</b>	1	0,21
	32A	13A	2	1	<b>LS38 Z A2</b>	1	0,21
			2	1	<b>LS16 Z A2+2</b>	1	0,26
	29A	10A	2	1	<b>LS25 Z A2+2</b>	1	0,26
	36A	11,5A	2	1	<b>LS32 Z A2+2</b>	1	0,26
	55A	13A	2	1	<b>LS38 Z A2+2</b>	1	0,26
			2	2	<b>LS16 Z A4</b>	1	0,23
	16A	10A	2	2	<b>LS25 Z A4</b>	1	0,23
	25A	11,5A	2	2	<b>LS32 Z A4</b>	1	0,23
	32A	13A	2	2	<b>LS38 Z A4</b>	1	0,23
			4	1	<b>LS16 Z A4.</b>	1	0,25
	16A	16A	4	1	<b>LS25 Z A4.</b>	1	0,25
	25A	25A	4	1	<b>LS32 Z A4.</b>	1	0,25
	32A	32A	4	1	<b>LS38 Z A4.</b>	1	0,25
			2	3	<b>LS16 Z A6</b>	1	0,38
	16A	10A	2	3	<b>LS25 Z A6</b>	1	0,38
	25A	11,5A	2	3	<b>LS32 Z A6</b>	1	0,38
	32A	13A	2	3	<b>LS38 Z A6</b>	1	0,38
			2	4	<b>LS16 Z A8</b>	1	0,43
	16A	10A	2	4	<b>LS25 Z A8</b>	1	0,43
	25A	11,5A	2	4	<b>LS32 Z A8</b>	1	0,43
	32A	13A	2	4	<b>LS38 Z A8</b>	1	0,43
			4	1	<b>LS16 Z A4+2</b>	1	0,48
	29A	29A	4	1	<b>LS25 Z A4+2</b>	1	0,48
	45A	45A	4	1	<b>LS32 Z A4+2</b>	1	0,48
	58A	58A	4	1	<b>LS38 Z A4+2</b>	1	0,48
			4	1	<b>LS16 Z A4.</b>	1	0,25
	16A	16A	4	1	<b>LS25 Z A4.</b>	1	0,25
	25A	25A	4	1	<b>LS32 Z A4.</b>	1	0,25
	32A	32A	4	1	<b>LS38 Z A4.</b>	1	0,25

Typenzusatz

**B ..A4B**

**O ..A4O**

**U ..A4U**

## ON-OFF Switches for Single Hole Mounting Ø22mm, without Escutcheon plate, IP66, c(UL)us Type 4X

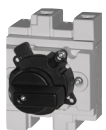

Replace the Type „Z“ with „ZO“

**LS.. ZO A.**

# ON-OFF Switches f. Base Mounting w. Door Clutch f. Single Hole, Plate 64<sup>□</sup>, IP66, cUL<sup>us</sup> Type 4X



DC21B / DC-PV1 600V DC	DC 1000V DC	Poles in series	Number of strings	Type	Pack pcs.	Weight kg/pcs.
16A	10A	2	1	<b>LS16 VZV A2</b>	1	0,22
25A	11,5A	2	1	<b>LS25 VZV A2</b>	1	0,22
32A	13A	2	1	<b>LS32 VZV A2</b>	1	0,22
45A	20A	2	1	<b>LS38 VZV A2</b>	1	0,22
48A	29A	2	1	<b>LS40 VZV A2</b>	1	0,51
55A	36A	2	1	<b>LS55 VZV A2</b>	1	0,51
65A	40A	2	1	<b>LS65 VZV A2</b>	1	0,51

Depth is adjustable

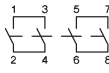

29A	10A	2	1	<b>LS16 VZV A2+2</b>	1	0,27
36A	11,5A	2	1	<b>LS25 VZV A2+2</b>	1	0,27
55A	13A	2	1	<b>LS32 VZV A2+2</b>	1	0,27
-	20A	2	1	<b>LS38 VZV A2+2</b>	1	0,27
68A	29A	2	1	<b>LS40 VZV A2+2</b>	1	0,55
85A	36A	2	1	<b>LS55 VZV A2+2</b>	1	0,55
85A	40A	2	1	<b>LS65 VZV A2+2</b>	1	0,55

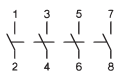

16A	10A	2	2	<b>LS16 VZV A4</b>	1	0,25
25A	11,5A	2	2	<b>LS25 VZV A4</b>	1	0,25
32A	13A	2	2	<b>LS32 VZV A4</b>	1	0,25
45A	20A	2	2	<b>LS38 VZV A4</b>	1	0,25
48A	29A	2	2	<b>LS40 VZV A4</b>	1	0,56
55A	36A	2	2	<b>LS55 VZV A4</b>	1	0,56
65A	40A	2	2	<b>LS65 VZV A4</b>	1	0,56

Type suffix



**B ..A4B**

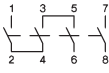

16A	16A	4	1	<b>LS16 VZV A4.</b>	1	0,26
25A	25A	4	1	<b>LS25 VZV A4.</b>	1	0,26
32A	32A	4	1	<b>LS32 VZV A4.</b>	1	0,26
45A	-	4	1	<b>LS38 VZV A4.</b>	1	0,26
48A	40A	4	1	<b>LS40 VZV A4.</b>	1	0,58
55A	55A	4	1	<b>LS55 VZV A4.</b>	1	0,58
-	-	4	1	<b>LS65 VZV A4.</b>	1	0,58

**O ..A4O**

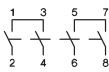

**U ..A4U**

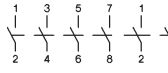
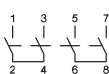

16A	10A	2	3	<b>LS16 VZV A6</b>	1	0,38
25A	11,5A	2	3	<b>LS25 VZV A6</b>	1	0,38
32A	13A	2	3	<b>LS32 VZV A6</b>	1	0,38
45A	20A	2	3	<b>LS38 VZV A6</b>	1	0,38
48A	29A	2	3	<b>LS40 VZV A6</b>	1	1,00
55A	36A	2	3	<b>LS55 VZV A6</b>	1	1,00
-	-	2	3	<b>LS65 VZV A6</b>	1	1,00

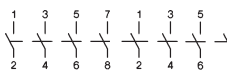

16A	10A	2	4	<b>LS16 VZV A8</b>	1	0,43
25A	11,5A	2	4	<b>LS25 VZV A8</b>	1	0,43
32A	13A	2	4	<b>LS32 VZV A8</b>	1	0,43
45A	20A	2	4	<b>LS38 VZV A8</b>	1	0,43
48A	29A	2	4	<b>LS40 VZV A8</b>	1	1,10
55A	36A	2	4	<b>LS55 VZV A8</b>	1	1,10
-	-	2	4	<b>LS65 VZV A8</b>	1	1,10

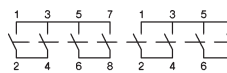

29A	29A	4	1	<b>LS16 VZV A4+2</b>	1	0,48
45A	45A	4	1	<b>LS25 VZV A4+2</b>	1	0,48
58A	58A	4	1	<b>LS32 VZV A4+2</b>	1	0,48
-	-	4	1	<b>LS38 VZV A4+2</b>	1	0,48
72A	72A	4	1	<b>LS40 VZV A4+2</b>	1	1,21
85A	85A	4	1	<b>LS55 VZV A4+2</b>	1	1,21
85A	85A	4	1	<b>LS65 VZV A4+2</b>	1	1,21

# ON-OFF Switches for Distribution Boards, IP40, Open Type



DDC21B / DC-PV1 600V DC 1000V DC		Poles in series	Number of strings	Type	Pack pcs.	Weight kg/pcs.
16A	10A	2	1	<b>LS16 SMA A2</b>	1	0,19
25A	11,5A	2	1	<b>LS25 SMA A2</b>	1	0,19
32A	13A	2	1	<b>LS32 SMA A2</b>	1	0,19
45A	20A	2	1	<b>LS38 SMA A2</b>	1	0,19
48A	29A	2	1	<b>LS40 SMA A2</b>	1	0,41
55A	36A	2	1	<b>LS55 SMA A2</b>	1	0,41
65A	40A	2	1	<b>LS65 SMA A2</b>	1	0,41

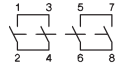

29A	10A	2	1	<b>LS16 SMA A2+2</b>	1	0,24
36A	11,5A	2	1	<b>LS25 SMA A2+2</b>	1	0,24
55A	13A	2	1	<b>LS32 SMA A2+2</b>	1	0,24
-	20A	2	1	<b>LS38 SMA A2+2</b>	1	0,24
68A	29A	2	1	<b>LS40 SMA A2+2</b>	1	0,52
85A	36A	2	1	<b>LS55 SMA A2+2</b>	1	0,52
85A	40A	2	1	<b>LS65 SMA A2+2</b>	1	0,52

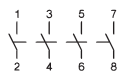

16A	10A	2	2	<b>LS16 SMA A4</b>	1	0,22
25A	11,5A	2	2	<b>LS25 SMA A4</b>	1	0,22
32A	13A	2	2	<b>LS32 SMA A4</b>	1	0,22
45A	20A	2	2	<b>LS38 SMA A4</b>	1	0,22
48A	29A	2	2	<b>LS40 SMA A4</b>	1	0,45
55A	36A	2	2	<b>LS55 SMA A4</b>	1	0,45
65A	40A	2	2	<b>LS65 SMA A4</b>	1	0,45

Type suffix

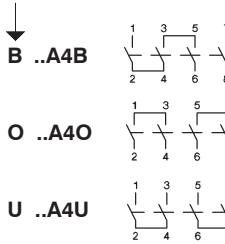

<b>B ..A4B</b>	16A	16A	4	1	<b>LS16 SMA A4.</b>	1	0,23
	25A	25A	4	1	<b>LS25 SMA A4.</b>	1	0,23
	32A	32A	4	1	<b>LS32 SMA A4.</b>	1	0,23
<b>O ..A4O</b>	45A	-	4	1	<b>LS32 SMA A4.</b>	1	0,23
	48A	40A	4	1	<b>LS40 SMA A4.</b>	1	0,49
	55A	55A	4	1	<b>LS55 SMA A4.</b>	1	0,49
<b>U ..A4U</b>	-	-	4	1	<b>LS65 SMA A4.</b>	1	0,49

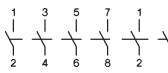

16A	10A	2	3	<b>LS16 SMA A6</b>	1	0,35
25A	11,5A	2	3	<b>LS25 SMA A6</b>	1	0,35
32A	13A	2	3	<b>LS32 SMA A6</b>	1	0,35
45A	20A	2	3	<b>LS38 SMA A6</b>	1	0,35
48A	29A	2	3	<b>LS40 SMA A6</b>	1	0,89
55A	36A	2	3	<b>LS55 SMA A6</b>	1	0,89
-	-	2	3	<b>LS65 SMA A6</b>	1	0,89

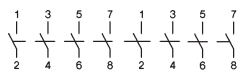

16A	10A	2	4	<b>LS16 SMA A8</b>	1	0,40
25A	11,5A	2	4	<b>LS25 SMA A8</b>	1	0,40
32A	13A	2	4	<b>LS32 SMA A8</b>	1	0,40
45A	20A	2	4	<b>LS38 SMA A8</b>	1	0,40
48A	29A	2	4	<b>LS40 SMA A8</b>	1	0,99
55A	36A	2	4	<b>LS55 SMA A8</b>	1	0,99
-	-	2	4	<b>LS65 SMA A8</b>	1	0,99

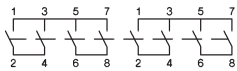

29A	29A	4	1	<b>LS16 SMA A4+2</b>	1	0,43
45A	45A	4	1	<b>LS25 SMA A4+2</b>	1	0,43
58A	58A	4	1	<b>LS32 SMA A4+2</b>	1	0,43
-	-	4	1	<b>LS38 SMA A4+2</b>	1	0,43
72A	72A	4	1	<b>LS40 SMA A4+2</b>	1	1,01
85A	85A	4	1	<b>LS55 SMA A4+2</b>	1	1,01
85A	85A	4	1	<b>LS65 SMA A4+2</b>	1	1,01

# Main Switches for Panel Mounting, Escutcheon plate 64<sup>2</sup>, IP66, Type 3R



padlock device SV4



DC21B / DC-PV1 600V DC 1000V DC		Poles in series	Number of strings	Type	Pack pcs.	Weight kg/pcs.
16A	10A	2	1	<b>LS16 EH4 A2</b>	1	0,21
25A	11,5A	2	1	<b>LS25 EH4 A2</b>	1	0,21
32A	13A	2	1	<b>LS32 EH4 A2</b>	1	0,21
45A	20A	2	1	<b>LS38 EH4 A2</b>	1	0,21
48A	29A	2	1	<b>LS40 EH4 A2</b>	1	0,43
55A	36A	2	1	<b>LS55 EH4 A2</b>	1	0,43
65A	40A	2	1	<b>LS65 EH4 A2</b>	1	0,43

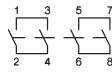

29A	10A	2	1	<b>LS16 EH4 A2+2</b>	1	0,26
36A	11,5A	2	1	<b>LS25 EH4 A2+2</b>	1	0,26
55A	13A	2	1	<b>LS32 EH4 A2+2</b>	1	0,26
-	20A	2	1	<b>LS38 EH4 A2+2</b>	1	0,26
68A	29A	2	1	<b>LS40 EH4 A2+2</b>	1	0,57
85A	36A	2	1	<b>LS55 EH4 A2+2</b>	1	0,57
85A	40A	2	1	<b>LS65 EH4 A2+2</b>	1	0,57

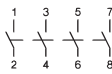

16A	10A	2	2	<b>LS16 EH4 A4</b>	1	0,24
25A	11,5A	2	2	<b>LS25 EH4 A4</b>	1	0,24
32A	13A	2	2	<b>LS32 EH4 A4</b>	1	0,24
45A	20A	2	2	<b>LS38 EH4 A4</b>	1	0,24
48A	29A	2	2	<b>LS40 EH4 A4</b>	1	0,50
55A	36A	2	2	<b>LS55 EH4 A4</b>	1	0,50
65A	40A	2	2	<b>LS65 EH4 A4</b>	1	0,50

Type suffix



**B ..A4B**

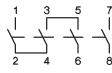

16A	16A	4	1	<b>LS16 EH4 A4.</b>	1	0,25
25A	25A	4	1	<b>LS25 EH4 A4.</b>	1	0,25
32A	32A	4	1	<b>LS32 EH4 A4.</b>	1	0,25

**O ..A4O**

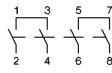

45A	-	4	1	<b>LS38 EH4 A4.</b>	1	0,25
48A	40A	4	1	<b>LS40 EH4 A4.</b>	1	0,53
55A	55A	4	1	<b>LS55 EH4 A4.</b>	1	0,53

**U ..A4U**

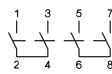

-	-	4	1	<b>LS65 EH4 A4.</b>	1	0,53
---	---	---	---	---------------------	---	------

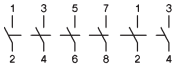

16A	10A	2	3	<b>LS16 EH4 A6</b>	1	0,37
25A	11,5A	2	3	<b>LS25 EH4 A6</b>	1	0,37
32A	13A	2	3	<b>LS32 EH4 A6</b>	1	0,37
45A	20A	2	3	<b>LS38 EH4 A6</b>	1	0,37
48A	29A	2	3	<b>LS40 EH4 A6</b>	1	0,53
55A	36A	2	3	<b>LS55 EH4 A6</b>	1	0,53
-	-	2	3	<b>LS65 EH4 A6</b>	1	0,53

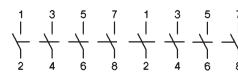

16A	10A	2	4	<b>LS16 EH4 A8</b>	1	0,42
25A	11,5A	2	4	<b>LS25 EH4 A8</b>	1	0,42
32A	13A	2	4	<b>LS32 EH4 A8</b>	1	0,42
45A	20A	2	4	<b>LS38 EH4 A8</b>	1	0,42
48A	29A	2	4	<b>LS40 EH4 A8</b>	1	1,10
55A	36A	2	4	<b>LS55 EH4 A8</b>	1	1,10
-	-	2	4	<b>LS65 EH4 A8</b>	1	1,10

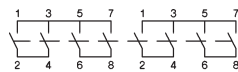

29A	29A	4	1	<b>LS16 EH4 A4+2</b>	1	0,47
45A	45A	4	1	<b>LS25 EH4 A4+2</b>	1	0,47
58A	58A	4	1	<b>LS32 EH4 A4+2</b>	1	0,47
-	-	4	1	<b>LS38 EH4 A4+2</b>	1	0,47
72A	72A	4	1	<b>LS40 EH4 A4+2</b>	1	1,21
85A	85A	4	1	<b>LS55 EH4 A4+2</b>	1	1,21
85A	85A	4	1	<b>LS65 EH4 A4+2</b>	1	1,21

## Extended Switch Shaft for all switches for panel mounting



Type suffix

+VW"x"

x = panel thickness

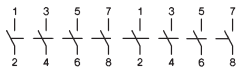
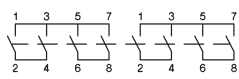

# Main Switches for Single Hole Mounting Ø22mm, Escutcheon plate 48°, IP66, Type 4X

	DC21B / DC-PV1		Poles in series	Number of strings	Type	Pack pcs.	Weight kg/pcs.
	600V DC	1000V DC					
	16A	10A	2	1	<b>LS16 ZH1 A2</b>	1	0,21
	25A	11,5A	2	1	<b>LS25 ZH1 A2</b>	1	0,21
	32A	13A	2	1	<b>LS32 ZH1 A2</b>	1	0,21
	45A	20A	2	1	<b>LS38 ZH1 A2</b>	1	0,21
Sperrvorrichtung SV1	29A	10A	2	1	<b>LS16 ZH1 A2+2</b>	1	0,27
	36A	11,5A	2	1	<b>LS25 ZH1 A2+2</b>	1	0,27
	55A	13A	2	1	<b>LS32 ZH1 A2+2</b>	1	0,27
	-	20A	2	1	<b>LS38 ZH1 A2+2</b>	1	0,27
	16A	10A	2	2	<b>LS16 ZH1 A4</b>	1	0,24
	25A	11,5A	2	2	<b>LS25 ZH1 A4</b>	1	0,24
	32A	13A	2	2	<b>LS32 ZH1 A4</b>	1	0,24
	45A	20A	2	2	<b>LS38 ZH1 A4</b>	1	0,24
Typenzusatz ↓ <b>B ..A4B</b> <b>O ..A4O</b> <b>U ..A4U</b>	16A	16A	4	1	<b>LS16 ZH1 A4.</b>	1	0,25
	25A	25A	4	1	<b>LS25 ZH1 A4.</b>	1	0,25
	32A	32A	4	1	<b>LS32 ZH1 A4.</b>	1	0,25
	45A	-	4	1	<b>LS38 ZH1 A4.</b>	1	0,25
	16A	10A	2	3	<b>LS16 ZH1 A6</b>	1	0,39
	25A	11,5A	2	3	<b>LS25 ZH1 A6</b>	1	0,39
	32A	13A	2	3	<b>LS32 ZH1 A6</b>	1	0,39
	45A	20A	2	3	<b>LS38 ZH1 A6</b>	1	0,39
	16A	10A	2	4	<b>LS16 ZH1 A8</b>	1	0,44
	25A	11,5A	2	4	<b>LS25 ZH1 A8</b>	1	0,44
	32A	13A	2	4	<b>LS32 ZH1 A8</b>	1	0,44
	45A	20A	2	4	<b>LS38 ZH1 A8</b>	1	0,44
	29A	29A	4	1	<b>LS16 ZH1 A4+2</b>	1	0,49
	45A	45A	4	1	<b>LS25 ZH1 A4+2</b>	1	0,49
	58A	58A	4	1	<b>LS32 ZH1 A4+2</b>	1	0,49
	-	-	4	1	<b>LS38 ZH1 A4+2</b>	1	0,49

# Main Switches, Single Hole Mounting Ø22mm, without Escutcheon plate, IP66, Type 4X

Replace the Type „ZH1“ with „ZOH1“ **LS.. ZOH1 A.**

# Main Switches f. Base Mounting, Door Clutch f. Single Hole, Plate 64<sup>□</sup>, IP66, Type 4X



Depth is adjustable  
see page 322  
padlock device SV4



DC21B / DC-PV1 600V DC	DC 1000V DC	Poles in series	Number of strings	Type	Pack pcs.	Weight kg/pcs.
16A	10A	2	1	<b>LS16 VZVH4 A2</b>	1	0,23
25A	11,5A	2	1	<b>LS25 VZVH4 A2</b>	1	0,23
32A	13A	2	1	<b>LS32 VZVH4 A2</b>	1	0,23
45A	20A	2	1	<b>LS38 VZVH4 A2</b>	1	0,23
48A	29A	2	1	<b>LS40 VZVH4 A2</b>	1	0,51
55A	36A	2	1	<b>LS55 VZVH4 A2</b>	1	0,51
65A	40A	2	1	<b>LS65 VZVH4 A2</b>	1	0,51

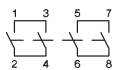

29A	10A	2	1	<b>LS16 VZVH4 A2+2</b>	1	0,28
36A	11,5A	2	1	<b>LS25 VZVH4 A2+2</b>	1	0,28
55A	13A	2	1	<b>LS32 VZVH4 A2+2</b>	1	0,28
-	20A	2	1	<b>LS38 VZVH4 A2+2</b>	1	0,28
68A	29A	2	1	<b>LS40 VZVH4 A2+2</b>	1	0,65
85A	36A	2	1	<b>LS55 VZVH4 A2+2</b>	1	0,65
85A	40A	2	1	<b>LS65 VZVH4 A2+2</b>	1	0,65

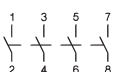

16A	10A	2	2	<b>LS16 VZVH4 A4</b>	1	0,26
25A	11,5A	2	2	<b>LS25 VZVH4 A4</b>	1	0,26
32A	13A	2	2	<b>LS32 VZVH4 A4</b>	1	0,26
45A	20A	2	2	<b>LS38 VZVH4 A4</b>	1	0,26
48A	29A	2	2	<b>LS40 VZVH4 A4</b>	1	0,58
55A	36A	2	2	<b>LS55 VZVH4 A4</b>	1	0,58
65A	40A	2	2	<b>LS65 VZVH4 A4</b>	1	0,58

Type suffix



**B ..A4B**

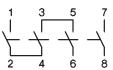

16A	16A	4	1	<b>LS16 VZVH4 A4.</b>	1	0,27
25A	25A	4	1	<b>LS25 VZVH4 A4.</b>	1	0,27
32A	32A	4	1	<b>LS32 VZVH4 A4.</b>	1	0,27
45A	-	4	1	<b>LS38 VZVH4 A4.</b>	1	0,27
48A	40A	4	1	<b>LS40 VZVH4 A4.</b>	1	0,62
55A	55A	4	1	<b>LS55 VZVH4 A4.</b>	1	0,62
-	-	4	1	<b>LS65 VZVH4 A4.</b>	1	0,62

**O ..A4O**

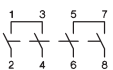

**U ..A4U**

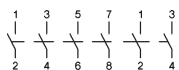
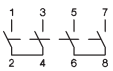

16A	10A	2	3	<b>LS16 VZVH4 A6</b>	1	0,39
25A	11,5A	2	3	<b>LS25 VZVH4 A6</b>	1	0,39
32A	13A	2	3	<b>LS32 VZVH4 A6</b>	1	0,39
45A	20A	2	3	<b>LS38 VZVH4 A6</b>	1	0,39
48A	29A	2	3	<b>LS40 VZVH4 A6</b>	1	1,00
55A	36A	2	3	<b>LS55 VZVH4 A6</b>	1	1,00
-	-	2	3	<b>LS65 VZVH4 A6</b>	1	1,00

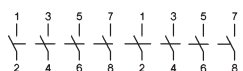

16A	10A	2	4	<b>LS16 VZVH4 A8</b>	1	0,44
25A	11,5A	2	4	<b>LS25 VZVH4 A8</b>	1	0,44
32A	13A	2	4	<b>LS32 VZVH4 A8</b>	1	0,44
45A	20A	2	4	<b>LS38 VZVH4 A8</b>	1	0,44
48A	29A	2	4	<b>LS40 VZVH4 A8</b>	1	1,11
55A	36A	2	4	<b>LS55 VZVH4 A8</b>	1	1,11
-	-	2	4	<b>LS65 VZVH4 A8</b>	1	1,11

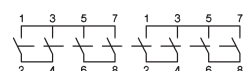

29A	29A	4	1	<b>LS16 VZVH4 A4+2</b>	1	0,49
45A	45A	4	1	<b>LS25 VZVH4 A4+2</b>	1	0,49
58A	58A	4	1	<b>LS32 VZVH4 A4+2</b>	1	0,49
-	-	4	1	<b>LS38 VZVH4 A4+2</b>	1	0,49
72A	72A	4	1	<b>LS40 VZVH4 A4+2</b>	1	1,22
85A	85A	4	1	<b>LS55 VZVH4 A4+2</b>	1	1,22
85A	85A	4	1	<b>LS65 VZVH4 A4+2</b>	1	1,22

# Main Switches for Distribution Boards, lockable, IP40, Open Type



Padlock device SV1



DC21B / DC-PV1 600V DC 1000V DC		Poles in series	Number of strings	Type	Pack pcs.	Weight kg/pcs.
16A	10A	2	1	<b>LS16 SMAH1 A2</b>	1	0,19
25A	11,5A	2	1	<b>LS25 SMAH1 A2</b>	1	0,19
32A	13A	2	1	<b>LS32 SMAH1 A2</b>	1	0,19
45A	20A	2	1	<b>LS38 SMAH1 A2</b>	1	0,19
48A	29A	2	1	<b>LS40 SMAH1 A2</b>	1	0,40
55A	36A	2	1	<b>LS55 SMAH1 A2</b>	1	0,40
65A	40A	2	1	<b>LS65 SMAH1 A2</b>	1	0,40

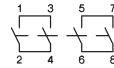

29A	10A	2	1	<b>LS16 SMAH1 A2+2</b> <sup>1)</sup>	1	0,25
36A	11,5A	2	1	<b>LS25 SMAH1 A2+2</b> <sup>1)</sup>	1	0,25
55A	13A	2	1	<b>LS32 SMAH1 A2+2</b> <sup>1)</sup>	1	0,25
-	20A	2	1	<b>LS38 SMAH1 A2+2</b> <sup>1)</sup>	1	0,25
68A	29A	2	1	<b>LS40 SMAH1 A2+2</b>	1	0,54
85A	36A	2	1	<b>LS55 SMAH1 A2+2</b>	1	0,54
85A	40A	2	1	<b>LS65 SMAH1 A2+2</b>	1	0,54

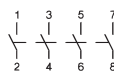

16A	10A	2	2	<b>LS16 SMAH1 A4</b> <sup>1)</sup>	1	0,22
25A	11,5A	2	2	<b>LS25 SMAH1 A4</b> <sup>1)</sup>	1	0,22
32A	13A	2	2	<b>LS32 SMAH1 A4</b> <sup>1)</sup>	1	0,22
45A	20A	2	2	<b>LS38 SMAH1 A4</b> <sup>1)</sup>	1	0,22
48A	29A	2	2	<b>LS40 SMAH1 A4</b>	1	0,47
55A	36A	2	2	<b>LS55 SMAH1 A4</b>	1	0,47
65A	40A	2	2	<b>LS65 SMAH1 A4</b>	1	0,47

Type suffix



**B ..A4B**

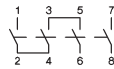

**O ..A4O**

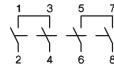

**U ..A4U**

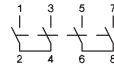

16A	16A	4	1	<b>LS16 SMAH1 A4.</b> <sup>1)</sup>	1	0,23
25A	25A	4	1	<b>LS25 SMAH1 A4.</b> <sup>1)</sup>	1	0,23
32A	32A	4	1	<b>LS32 SMAH1 A4.</b> <sup>1)</sup>	1	0,23
45A	-	4	1	<b>LS38 SMAH1 A4.</b> <sup>1)</sup>	1	0,23
48A	40A	4	1	<b>LS40 SMAH1 A4.</b>	1	0,50
55A	55A	4	1	<b>LS55 SMAH1 A4.</b>	1	0,50
-	-	4	1	<b>LS65 SMAH1 A4.</b>	1	0,50

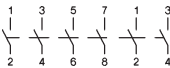

16A	10A	2	3	<b>LS16 SMAH1 A6</b>	1	0,36
25A	11,5A	2	3	<b>LS25 SMAH1 A6</b>	1	0,36
32A	13A	2	3	<b>LS32 SMAH1 A6</b>	1	0,36
45A	20A	2	3	<b>LS38 SMAH1 A6</b>	1	0,36
48A	29A	2	3	<b>LS40 SMAH1 A6</b>	1	0,90
55A	36A	2	3	<b>LS55 SMAH1 A6</b>	1	0,90
-	-	2	3	<b>LS65 SMAH1 A6</b>	1	0,90

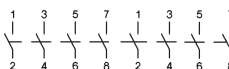

16A	10A	2	4	<b>LS16 SMAH1 A8</b>	1	0,41
25A	11,5A	2	4	<b>LS25 SMAH1 A8</b>	1	0,41
32A	13A	2	4	<b>LS32 SMAH1 A8</b>	1	0,41
45A	20A	2	4	<b>LS38 SMAH1 A8</b>	1	0,41
48A	29A	2	4	<b>LS40 SMAH1 A8</b>	1	0,41
55A	36A	2	4	<b>LS55 SMAH1 A8</b>	1	0,41
-	-	2	4	<b>LS65 SMAH1 A8</b>	1	0,41

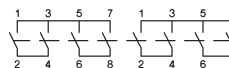

29A	29A	4	1	<b>LS16 SMAH1 A4+2</b>	1	0,46
45A	45A	4	1	<b>LS25 SMAH1 A4+2</b>	1	0,46
58A	58A	4	1	<b>LS32 SMAH1 A4+2</b>	1	0,46
-	-	4	1	<b>LS38 SMAH1 A4+2</b>	1	0,46
72A	72A	4	1	<b>LS40 SMAH1 A4+2</b>	1	1,12
85A	85A	4	1	<b>LS55 SMAH1 A4+2</b>	1	1,12
85A	85A	4	1	<b>LS65 SMAH1 A4+2</b>	1	1,12

## 1) Main Switches for Distribution Boards with low height handle, IP40, Open Type

With type suffix „+SV1N“, e.g.: **LS.. SMAH1 A2+2 +SV1N**

# Main Switches in Plastic Enclosure, Escutcheon plate 64<sup>0</sup>, IP66/67, Type 4X



DC21B / DC-PV1 600V DC	DC 1000V DC	Poles in series	Number of strings	Type	Pack pcs.	Weight kg/pcs.
16A	10A	2	1	<b>LS16 PFLH4 A2</b>	1	0,43
25A	11,5A	2	1	<b>LS25 PFLH4 A2</b>	1	0,43
32A	13A	2	1	<b>LS32 PFLH4 A2</b>	1	0,43
45A	20A	2	1	<b>LS38 PFLH4 A2</b>	1	0,43
48A	29A	2	1	<b>LS40 PFLH4 A2</b> <sup>1)</sup>	1	1,59
55A	36A	2	1	<b>LS55 PFLH4 A2</b> <sup>1)</sup>	1	1,59
65A	40A	2	1	<b>LS65 PFLH4 A2</b> <sup>1)</sup>	1	1,59

Padlock device SV4

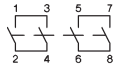

29A	10A	2	1	<b>LS16 PFLH4 A2+2</b>	1	0,49
36A	11,5A	2	1	<b>LS25 PFLH4 A2+2</b>	1	0,49
55A	13A	2	1	<b>LS32 PFLH4 A2+2</b>	1	0,49
-	20A	2	1	<b>LS38 PFLH4 A2+2</b>	1	0,49
68A	29A	2	1	<b>LS40 PFLH4 A2+2</b> <sup>1)</sup>	1	1,74
85A	36A	2	1	<b>LS55 PFLH4 A2+2</b> <sup>1)</sup>	1	1,74
85A	40A	2	1	<b>LS65 PFLH4 A2+2</b> <sup>1)</sup>	1	1,74

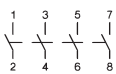

16A	10A	2	2	<b>LS16 PFLH4 A4</b>	1	0,46
25A	11,5A	2	2	<b>LS25 PFLH4 A4</b>	1	0,46
32A	13A	2	2	<b>LS32 PFLH4 A4</b>	1	0,46
45A	20A	2	2	<b>LS38 PFLH4 A4</b>	1	0,46
48A	29A	2	2	<b>LS40 PFLH4 A4</b> <sup>1)</sup>	1	1,67
55A	36A	2	2	<b>LS55 PFLH4 A4</b> <sup>1)</sup>	1	1,67
65A	40A	2	2	<b>LS65 PFLH4 A4</b> <sup>1)</sup>	1	1,67

Type suffix



**B ..A4B**

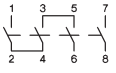

16A	16A	4	1	<b>LS16 PFLH4 A4.</b>	1	0,47
25A	25A	4	1	<b>LS25 PFLH4 A4.</b>	1	0,47
32A	32A	4	1	<b>LS32 PFLH4 A4.</b>	1	0,47
45A	-	4	1	<b>LS38 PFLH4 A4.</b>	1	0,47
48A	40A	4	1	<b>LS40 PFLH4 A4.</b> <sup>1)</sup>	1	1,70
55A	55A	4	1	<b>LS55 PFLH4 A4.</b> <sup>1)</sup>	1	1,70
-	-	4	1	<b>LS65 PFLH4 A4.</b> <sup>1)</sup>	1	1,70

**O ..A4O**

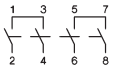

**U ..A4U**

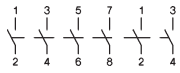
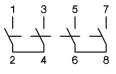

16A	10A	2	3	<b>LS16 PFLH4 A6</b>	1	1,53
25A	11,5A	2	3	<b>LS25 PFLH4 A6</b>	1	1,53
32A	13A	2	3	<b>LS32 PFLH4 A6</b>	1	1,53
45A	20A	2	3	<b>LS38 PFLH4 A6</b>	1	1,53
48A	29A	2	3	<b>LS40 PFLH4 A6</b>	1	1,87
55A	36A	2	3	<b>LS55 PFLH4 A6</b>	1	1,87
-	-	2	3	<b>LS65 PFLH4 A6</b>	1	1,87

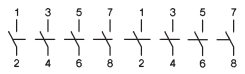

16A	10A	2	4	<b>LS16 PFLH4 A8</b>	1	1,58
25A	11,5A	2	4	<b>LS25 PFLH4 A8</b>	1	1,58
32A	13A	2	4	<b>LS32 PFLH4 A8</b>	1	1,58
45A	20A	2	4	<b>LS38 PFLH4 A8</b>	1	1,58
48A	29A	2	4	<b>LS40 PFLH4 A8</b>	1	1,94
55A	36A	2	4	<b>LS55 PFLH4 A8</b>	1	1,94
-	-	2	4	<b>LS65 PFLH4 A8</b>	1	1,94

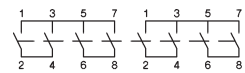

29A	29A	4	1	<b>LS16 PFLH4 A4+2</b>	1	1,63
45A	45A	4	1	<b>LS25 PFLH4 A4+2</b>	1	1,63
58A	58A	4	1	<b>LS32 PFLH4 A4+2</b>	1	1,63
-	-	4	1	<b>LS38 PFLH4 A4+2</b>	1	1,63
72A	72A	4	1	<b>LS40 PFLH4 A4+2</b>	1	2,07
85A	85A	4	1	<b>LS55 PFLH4 A4+2</b>	1	2,07
85A	85A	4	1	<b>LS65 PFLH4 A4+2</b>	1	2,07

<sup>1)</sup> **Small Plastic Enclosure:** Type plus Type-suffix „+PF2“

z.B.: **LS.. PFLH4 A2+2 +PF2** (Dimensions see page 325)

# Technical Data

Kind of current	Category	Typical applications	Test conditions for the number of on-load operating cycles (normal service)						Test conditions for making and breaking capacities (operation in fault case)											
			Make			Break			Make			Break								
			I/le	U/Ue	L/R	Ic/le	Ur/Ue	L/R	I/le	U/Ue	L/R	Ic/le	Ur/Ue	L/R						
Direct current	<b>DC21A</b> frequent operation	<b>DC21B</b> infrequent operation	Switching of resistive loads including moderate overloads						1	1	1ms	1	1	1ms	1,5	1,05	1ms	1,5	1,05	1ms
	<b>DC22A</b> frequent operation	<b>DC22B</b> infrequent operation	Switching of mixed resistive a.induct. loads incl. moderate overloads (shunt motors)						1	1	2ms	1	1	2ms	4	1,05	2,5ms	4	1,05	2,5ms
	<b>DC-PV1</b>		Switching of single PV string(s) without reverse- and overcurrents.						1	1	1ms	1	1	1ms	1,5	1,05	1ms	1,5	1,05	1ms
	<b>DC-PV2</b>		Switching of several PV strings with reverse- and overcurrents.						1	1	1ms	1	1	1ms	4	1,05	1ms	4	1,05	1ms

## Data according to IEC 60947-3, VDE 0660, GB/T14048.3 (CCC China)



Main contacts		Typ	LS16	LS25	LS32	LS38	LS40	LS55	
Rated thermal current $I_{th}$		A	16	25	32	45	48	55	
Rated insulation voltage $U_i^{(1)}$		V	1000	1000	1000	1000	1500	1500	
Rated insulation voltage $U_i^{(2)}$		V	1500	1500	1500	1500	1500	1500	
Distance of contacts (per pole)		mm	8	8	8	8	8	8	
<b>DC21A and DC21B</b>	1 pole	300V A	16	23	27	27	40	55	
		400V A	12/14	14/22	16/25	16/25	30/33	40/44	
	A1	500V A	9/10	11/17	13/20	13/20	19/24	25/32	
		600V A	6/7	8/12	10/15	10/15	15/19	20/25	
	1	700V A	4,5/5	6	7,5	7,5	10/12	15/18	
		800V A	3	4	5	5	8/10	10/13	
	only DC21B	900V A	2,5/3	3	4	4	6/8	8/10	
		1000V A	1,5/2	2	2,5/3	2,5/3	4/5	6/8	
	2 poles in series	500V A	16	25	32	-/45	48	55	
		600V A	16	25	32	-/45	48	55	
	A2	700V A	16	23/25	27/32	-/36	35/37	55	
		800V A	16/16	20	-/23	-/30	35	45/55	
	1 2	900V A	13/16	16/17	-/20	-/25	25/31	35/43	
		1000V A	9/10	11/11,5	13	-/20	25/29	-/36	
	1200V A	6/7	8/8,5	10	10	10/11	15/17		
		1500V A	3	4/5	5/6	-/6	6/7,5	7,5/10	
	2 poles in series + 2 poles parallel	500V A	29	45	58	-/65	72	85	
		600V A	29	45	50/55		64/68	80/85	
	A2+2	700V A	16/22	23/27	27/32		35/49	55/77	
		800V A	16/17	20	-/23	-/30	35/42	45/63	
	1 2 3 4	900V A	13/16	16/17	-/20		25/31	35/43	
		1000V A	9/10	11/11,5	13	-/20	23/29	25/36	
	1200V A	6/7	8/8,5	10	10	10/11	15/17		
		1500V A	3	4/5	5/6	-/6	6/7,5	7,5/10	
3 poles in series + 2 poles parallel	500V A	29	45	58		72	85		
	600V A	29	45	50/58		72	85		
A3+2	700V A	29	38/43	45/55		72	85		
	800V A	29	38/40	-/51		68	85		
1 2 3 4 5 6	900V A	29	-/38	-/47		62	78		
	1000V A	29	-/38	-/45		58	70		
1200V A	12	14/25	16/28						
	1500V A	9	11/14	13/20					
4 poles in series	500V A	16	25	32	-/45	48	55		
	600V A	16	25	32	-/45	48	55		
A4	700V A	16	25	32		40	55		
	800V A	16	25	32		40	55		
1 2 3 4	900V A	16	25	32		40	55		
	1000V A	16	25	32	-/38	40	55		
1200V A	16	25	32		40	55			
	1500V A	16	20/25	23/32	-/32	30/40	40/55		
4 poles in series + 2 poles parallel	500V A	29	45	58	-/65	72	85		
	600V A	29	45	58		72	85		
A4+2	700V A	29	45	-/58		72	85		
	800V A	29	45	-/58		72	85		
1 2 3 4 5 6 7 8	900V A	29	45	-/58		72	85		
	1000V A	29	-/45	-/58	-/65	-/72	-/85		
1200V A	29	-/45	50	-/50	-/56	-/65			
	1500V A	16	20/26	23/32	-/32	-/42	-/55		
<b>Rated operational current <math>I_e</math></b>									
<b>AC21B</b>	A2, A4	$U_e$ max. 440V	A	16	25	32	45	48	55
	A2+2	$U_e$ max. 440V	A	29	45	58		72	85

1) Suitable at overvoltage category I to III, pollution degree 3 (standard-industry):  $U_{imp} = 8kV$ .

2) Suitable at overvoltage category I to III, pollution degree 2 (min. IP55):  $U_{imp} = 8kV$ .

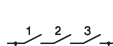
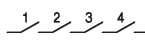
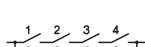

# Technical Data

Data according to IEC 60947-3, VDE 0660

Main contacts	Type		LS16	LS25	LS32	LS38	LS40	LS55	LS65	
<b>Rated operational current I<sub>e</sub></b>										
<b>DC-PV1</b> 1 Pole A1 	300V	A	16	23	27	27	40	55	65	
	400V	A	14	22	25	25	33	44	50	
	500V	A	10	17	20	20	24	32	40	
	600V	A	7	12	15	15	19	25	30	
	700V	A	5	6	7,5	7,5	12	18	21	
	800V	A	3	4	5	5	10	13	15	
	900V	A	3	3	4	4	8	10	10	
	1000V	A	2	2	3	3	5	8	8	
	<hr/>									
	2 Poles in series A2 	500V	A	16	25	32	45	48	55	75
600V		A	16	25	32	45	48	55	75	
700V		A	16	25	32	36	37	55	75	
800V		A	16	20	23	30	35	55	65	
900V		A	16	17	20	25	31	43	55	
1000V		A	10	11,5	13	20	29	36	40	
1100V		A	8	10	11,5	-	19	25	-	
1200V		A	7	8,5	10	10	11	17	17	
1300V		A	6	7	8	-	10	14	-	
1400V		A	5	6	7	-	9	12	-	
1500V		A	3	5	6	6	8	10	10	
<hr/>										
2 Poles in series + 2 Pole parallel A2+2 		500V	A	29	45	58	65	72	85	85
		600V	A	29	45	55	58	68	85	85
	700V	A	22	27	32	36	49	77	80	
	800V	A	17	20	23	30	42	63	65	
	900V	A	16	17	20	25	31	43	55	
	1000V	A	10	11,5	13	20	29	36	40	
	1100V	A	8	10	11,5	-	19	25	-	
	1200V	A	7	8,5	10	10	11	17	17	
	1300V	A	6	7	8	-	10	14	-	
	1400V	A	5	6	7	-	9	12	-	
	1500V	A	3	5	6	6	8	10	10	
	<hr/>									
	3 Poles in series + 2 Poles parallel A3+2 	500V	A	29	45	58	-	72	85	-
		600V	A	29	45	58	-	72	85	-
700V		A	29	43	55	-	72	85	-	
800V		A	29	40	51	-	68	85	-	
900V		A	29	38	47	-	62	78	-	
1000V		A	29	38	45	-	58	70	-	
1100V		A	19	27	37	-	-	-	-	
1200V		A	17	25	28	-	-	-	-	
1300V		A	15	21	25	-	-	-	-	
1400V		A	12	18	22	-	-	-	-	
1500V		A	10	14	20	-	-	-	-	
<hr/>										
4 Poles in series A4 		500V	A	16	25	32	45	48	55	75
		600V	A	16	25	32	45	48	55	75
	700V	A	16	25	32	45	48	55	75	
	800V	A	16	25	32	45	48	55	75	
	900V	A	16	25	32	45	48	55	75	
	1000V	A	16	25	32	38	40	55	75	
	1100V	A	16	25	32	32	40	55	65	
	1200V	A	16	25	32	32	40	55	65	
	1300V	A	16	25	32	32	40	55	65	
	1400V	A	16	25	32	32	40	55	65	
	1500V	A	16	25	32	32	40	55	65	
	<hr/>									
	4 Poles in series + 2 Poles parallel A4+2 	500V	A	29	45	58	65	72	85	85
		600V	A	29	45	58	65	72	85	85
700V		A	29	45	58	65	72	85	85	
800V		A	29	45	58	65	72	85	85	
900V		A	29	45	58	65	72	85	85	
1000V		A	29	45	58	65	72	85	85	
1100V		A	29	45	54	-	60	68	-	
1200V		A	29	45	50	50	56	65	65	
1300V		A	26	39	44	-	50	61	-	
1400V		A	23	33	38	-	46	-	-	
1500V		A	20	26	32	32	42	55	55	

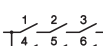
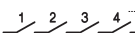
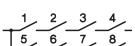

# Technical Data

Data according to IEC 60947-3, VDE 0660

Main contacts	Type		LS16	LS25	LS32	LS38	LS40	LS55	LS65	
<b>Rated operational current I<sub>e</sub></b>										
<b>DC-PV2</b> 1 Pole A1 	300V A		16	23	27	27	40	55	-	
	400V A		14	18	20	20	30	40	-	
	500V A		10	12	14	14	19	25	-	
	600V A		5	6	8	8	10	13	-	
	700V A		1,5	2	3	3	7	10	-	
	800V A		1,5	2	3	3	6	8	-	
	900V A		1	1,5	2	2	5	6	-	
	1000V A		1	1,5	2	2	3	4	-	
	2 Poles in series A2 	500V A		16	25	32	38	40	55	65
		600V A		14	21	27	31	40	55	65
700V A			13	19	22	25	35	55	65	
800V A			12	15	17	19	33	49	52	
900V A			8	10	12	14	25	35	38	
1000V A			4	5	6	7	16	20	20	
1100V A			3	4	5	-	11	15	-	
1200V A			2	3	4	4	8	12	12	
1300V A			1,5	2	3	-	7	10	-	
1400V A			1	2	3	-	7	9	-	
1500V A			1	1,5	2	2	6	8	8	
2 Poles in series + 2 Poles parallel A2+2 		500V A		25	39	50	58	72	85	85
		600V A		20	32	35	38	60	75	75
		700V A		13	19	22	25	38	60	65
	800V A		12	15	17	19	33	49	52	
	900V A		8	10	12	14	25	35	38	
	1000V A		4	5	6	7	16	20	20	
	1100V A		3	4	5	-	11	15	-	
	1200V A		2	3	4	4	8	12	12	
	1300V A		1,5	2	3	-	7	10	-	
	1400V A		1	2	3	-	7	9	-	
	1500V A		1	1,5	2	2	6	8	8	
	3 Poles in series + 2 Poles parallel A3+2 	500V A		27	45	58	65	72	85	-
		600V A		22	34	44	48	78	-	-
		700V A		20	28	34	35	62	69	-
800V A			18	24	29	31	53	61	-	
900V A			16	20	24	24	55	-	-	
1000V A			14	18	20	20	35	50	-	
1100V A			-	-	-	-	-	-	-	
1200V A			11	13	15	15	-	-	-	
1300V A			-	-	-	-	-	-	-	
1400V A			-	-	-	-	-	-	-	
1500V A			4	6	8	8	-	-	-	
4 Poles in series A4 		500V A		16	25	32	45	48	55	65
		600V A		16	25	32	45	48	55	65
		700V A		16	25	32	45	48	55	65
	800V A		16	25	32	38	40	55	65	
	900V A		16	25	32	38	40	55	65	
	1000V A		16	25	32	38	40	55	65	
	1100V A		15	25	32	-	-	55	-	
	1200V A		13,5	21	27	27	40	55	55	
	1300V A		12	19	24	-	-	50	-	
	1400V A		10,5	16	21	-	-	45	-	
	1500V A		9	14	18	18	30	40	40	
	4 Poles in series + 2 Poles parallel A4+2 	500V A		29	45	58	65	72	85	-
		600V A		29	45	58	65	72	85	-
		700V A		25	40	53	65	72	80	-
800V A			21	35	45	60	67	75	-	
900V A			18	30	37	55	59	70	-	
1000V A			16	25	32	50	52	64	-	
1100V A			-	-	-	-	44	59	-	
1200V A			13,5	21	27	27	40	55	-	
1300V A			-	-	-	-	36	50	-	
1400V A			-	-	-	-	33	45	-	
1500V A			9	14	18	18	30	40	-	

# Technical Data

Data according to IEC 60947-3, VDE 0660

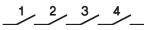



Main contacts	Type	LS16	LS25	LS32	LS38	LS40	LS55/LS65
<b>Rated operational current I<sub>e</sub></b>	500V A	1	1,25	1,5	x	x	2,5
<b>DC22B</b>	600V A	0,5	0,75	1	x	x	2,0
1 pole	800V A	0,3	0,4	0,5	x	x	1,5
A1	1000V A	0,15	0,2	0,25	x	x	1,0
	1200V A	-	-	-	x	x	x
	1500V A	-	-	-	x	x	x
2 poles in series	500V A	7	8	9	x	x	x
A2	600V A	5,5	6	6,5	x	x	x
	800V A	2	2,5	3	x	x	x
	1000V A	1	1,5	2	x	x	x
	1200V A	-	-	-	x	x	x
	1500V A	-	-	-	x	x	x
4 poles in series	500V A	16	25	32	x	x	x
A4	600V A	16	25	27,5	x	x	x
	800V A	11,5	12	12,5	x	x	x
	1000V A	8	9	10	x	x	x
	1200V A	-	-	-	x	x	x
	1500V A	-	-	-	x	x	x
<b>Rated conditional short-circuit current</b>	kA <sub>eff</sub>	5	5	5	5	10	10
Max. fuse size	gL (gG)	A 40	63	80	80	125	160
Mechanical life	x10 <sup>3</sup>	10	10	10	10	10	10
Rated short-time withstand current (1s)	I <sub>cw</sub> A2, A4, A6, A8 A2+2, A3+2, A4+2	A 800 A 1300	900 1500	1000 1700	1000 1700	A2, A4: 1200 A2+2: 2000	A2, A4: 1400 A2+2: 2400
Short circuit making capacity	I <sub>cm</sub> A2, A4, A6, A8 A2+2, A3+2, A4+2	A 800 A 1300	900 1500	1000 1700	1000 1700	A2, A4: 1200 A2+2: 2000	A2, A4: 1400 A2+2: 2400
<b>Maximum cable cross sections</b> (incl. jumper)		LSV-B1	LSV-B1	LSV-B1	LSV-B1	LSV-B2	LSV-B2
solid or stranded	mm <sup>2</sup>	4 - 16	4 - 16	4 - 16	4-16	2,5 - 25	2,5 - 25
flexible	mm <sup>2</sup>	4 - 10	4 - 10	4 - 10	4-10	2,5 - 16	2,5 - 16
flexible (+ multicore cable end)	mm <sup>2</sup>	4 - 10	4 - 10	4 - 10	4-10	1,5 - 16	1,5 - 16
Size of terminal screw		M4 Pz2	M4 Pz2	M4 Pz2	M4 Pz2	M5 Pz2	M5 Pz2
Tightening torque	Nm	1,8 - 2	1,8 - 2	1,8 - 2	1,8 - 2	2,5 - 2,8	2,5 - 2,8
2 cables per terminal without jumper LSV-B1 / LSV-B2							
solid or stranded	mm <sup>2</sup>	16+(1,5-2,5) / 10+(1,5-6) / 6+(1,5-10) / 4+(1,5-10)				16+(1,5-2,5) / 10+(1,5-10) / 6+(1,5-10) / 4+(1,5-10)	
flexible & flexible + multicore cable end	mm <sup>2</sup>	16+(1,5-2,5) / 10+(1,5-4) / 6+(1,5-6)				16+(1,5-6) / 10+(1,5-10) / 6+(1,5-16) / 4+(1,5-16)	
stranded	AWG	8+(16-12) / 10+(16-10) / 12+(16-8) 14+(16-8)				3+(18-10) / 4+(18-10) / 6+(18-8) 8+(18-8)	
solid	AWG	10+(16-12) / 12+(16-10) 14+(16-10)				10+(16-10) / 12+(16-10) / 14+(16-10) 12+(16-10)/14+(16-10)	
<b>Maximum ambient temperature</b>							
Operation	open °C	-40 to +65					
	enclosed °C	-40 to +45					
Storage	°C	-50 to +90					
<b>Power loss</b> per switch at I <sub>e</sub> max.		A	A	A		A	A
A2	(A)/W	(16)/ 1	(25)/ 2,3	(32)/ 3,7		(40)/ 4	(55)/ 7,5
A4	(A)/W	(16)/ 2	(25)/ 4,6	(32)/ 7,4		(40)/ 8	(55)/ 15
A6	(A)/W	(16)/ 3	(25)/ 6,9	(32)/ 11,1		(40)/ 12	(55)/ 22,5
A8	(A)/W	(16)/ 4	(25)/ 9,2	(32)/ 14,8		(40)/ 16	(55)/ 30
A2+2	(A)/W	(29)/1,5	(45)/ 3,7	(58)/ 6		(72)/ 6,5	(85)/ 9
A3+2	(A)/W	(29)/2,3	(45)/ 5,6	(58)/ 9		(72)/ 9,8	(85)/ 14
A4+2	(A)/W	(29)/3	(45)/ 7,4	(58)/ 12		(72)/ 13	(85)/ 18
<b>Contact resistance</b> per pole	mΩ	1,75	1,75	1,75		1,25	1,25

x pending





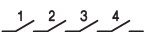
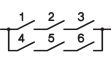
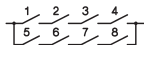

# Technical Data

Daten according to UL5081  File E359344 Category np.: NMSJ and UL508  File E332938, Category no.: NRNT2, NRNT8

Typ				LS16	LS25	LS32	LS38	LS40	LS55	LS65	
Ampere-Rating "General use"  1 Pole	DC	350V	A	4	5	6	6	7,1	10,0	10,0	
		500V	A	4	5	6	6	5,7	7,0	7,0	
		600V	A	4	5	6	6	5,0	5,8	5,8	
		700V	A	-	-	-	-	3,9	5,0	5,0	
		800V	A	-	-	-	-	3,2	4,4	4,4	
		900V	A	-	-	-	-	2,5	3,5	3,5	
		1000V	A	-	-	-	-	1,5	2,0	2,0	
		 2 Poles in series A2	350V	A	16	25	32	45	48	55	65
			500V	A	16	25	32	45	48	55	65
			600V	A	16	25	32	36	40	55	65
700V	A		-	-	-	-	32	46	50		
800V	A		-	-	-	-	26	37	40		
900V	A		-	-	-	-	20	28	32		
1000V	A		-	-	-	-	16	20	25		
 2 Poles in series + 2 Poles parallel A2+2	350V		A	29	45	58	58	72	85	85	
	500V		A	29	41	43	45	53	66	73	
	600V		A	21	30	33	36	42	55	65	
	700V	A	-	-	-	-	35	47	50		
	800V	A	-	-	-	-	30	40	40		
	900V	A	-	-	-	-	26	32	32		
	1000V	A	-	-	-	-	22	25	25		
	 4 Poles in series A4	350V	A	16	25	32	45	48	55	65	
		500V	A	16	25	32	45	48	55	65	
		600V	A	16	25	32	36	40	55	65	
700V		A	-	-	-	-	40	55	65		
800V		A	-	-	-	-	40	55	65		
900V		A	-	-	-	-	40	55	65		
1000V		A	-	-	-	-	40	55	65		
 3 Poles in series + 2 Poles parallel A3+2		350V	A	29	45	58	58	72	85	85	
		500V	A	29	41	50	50	56	80	85	
		600V	A	21	38	45	45	52	65	72	
	700V	A	-	-	-	-	46	58	66		
	800V	A	-	-	-	-	40	51	60		
	900V	A	-	-	-	-	36	45	54		
	1000V	A	-	-	-	-	33	42	48		
	 4 Poles in series + 2 Poles parallel A4+2	350V	A	29	45	58	58	80	85	85	
		500V	A	29	45	58	58	71	85	85	
		600V	A	29	45	50	50	65	85	85	
700V		A	-	-	-	-	58	76	85		
800V		A	-	-	-	-	51	71	76		
900V		A	-	-	-	-	45	67	73		
1000V		A	-	-	-	-	42	64	70		
AC-Rating "General use"		2 Poles in series  1 phase	600V	A	16	25	32	-	40	55	-
			277V	A	-	-	50	-	72	85	-
			+ 2 Poles parallel  3 phase	480V	A	-	-	32	-	40	55
	Fuse size (RK5) Industrial Control Switch			A	40	60	80	80	-	-	-
5kA / 600V	A	-	-	-	-	160	160	160			
5kA/1000V	A	-	-	-	-	160	160	160			
<b>Max. cable cross sections</b> incl. jumpers LSV-B1 / LSV-B2											
solid			AWG	12 - 10	12 - 10	12 - 10	12 - 10	16 - 10	16 - 10		
flexible or stranded			AWG	12 - 6	12 - 6	12 - 6	12 - 6	14 - 3	14 - 3		
flexible (+ multicore cable end)			AWG	12 - 6	12 - 6	12 - 6	12 - 6	16 - 4	16 - 4		
Size of terminal screw				M4 Pz2	M4 Pz2	M4 Pz2	M4 Pz2	M5 Pz2	M5 Pz2		
Tightening torque			Nm	1,8 - 2	1,8 - 2	1,8 - 2	1,8 - 2	2,5 - 2,8	2,5 - 2,8		
Protection class of terminals <sup>1)</sup>				IP20	IP20	IP20	IP20	IP20	IP20	IP20	

1) Protection class of the terminals with connected, insulated conductors.

## Approvals

Country	USA, UL5081	US, Canada UL508	Europe	China CCC	CB- Certificates	EAC
Type						
LS16	o	o	/	o	o	o
LS25	o	o	/	o	o	o
LS32	o	o	/	o	o	o
LS38	o	o	/	o	o	o
LS40, LS55	o	o	/	o	o	o
LS65	o	o	/	-	o	o

o In standard version approved

/ No testing required CE

x In test

- Not provided for test

## Technical Data

Example for maximum currents according to ambient temperatures and cable cross sections:

Switch **open** LS16..., 2 contacts in series (A2)

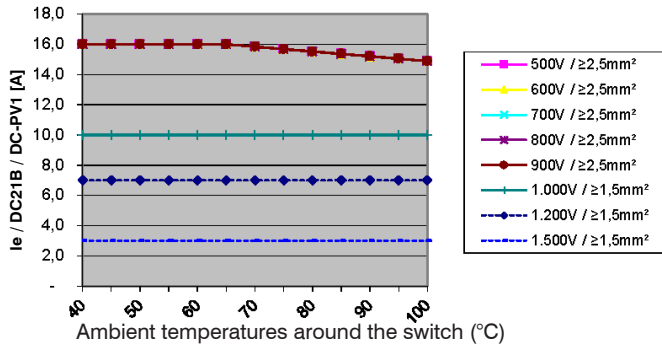

Switch **open** LS16 ..., 2 contacts in series + 2 parallel (A2+2)

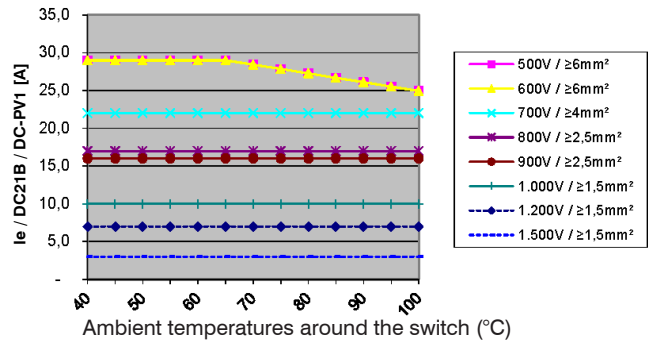

Switch **enclosed** LS16 PFL..., 2 contacts in series (A2)

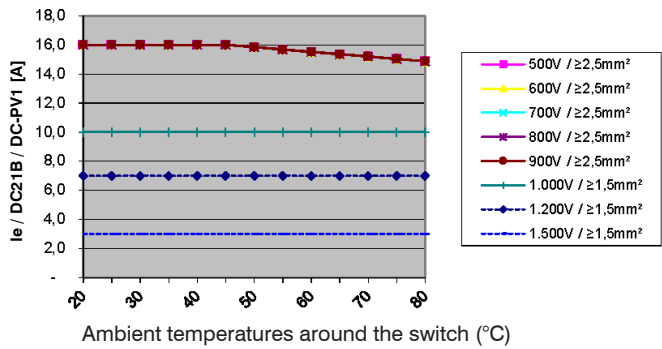

Switch **enclosed** LS16 PFL..., 2 contacts in series + 2 parallel (A2+2)

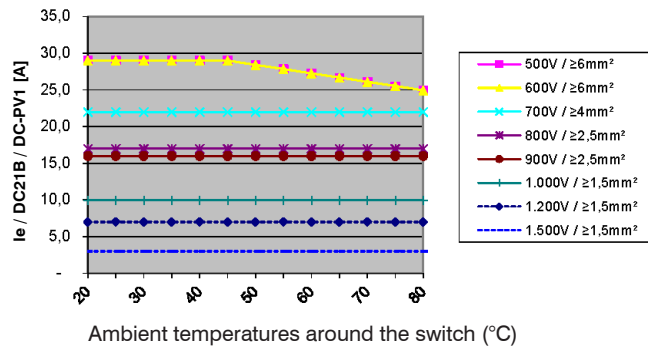

All data about maximum currents according to ambient temperatures and cable cross sections for switches LS16.. to LS65.. (open or enclosed) please find under ➡ [www.benedict.at](http://www.benedict.at) (Button "Customers").

## Dimensions

**LS16 E.., LS25 E.., LS32 E.., LS38E..**  
**..A2**

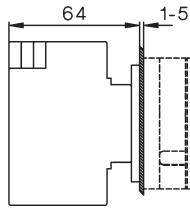
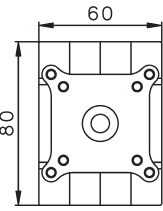
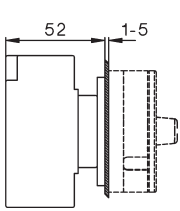

**LS16 E.., LS25 E.., LS32 E.., LS38 E**  
**..A6, ..A8, ..A3+2, ..A4+2**

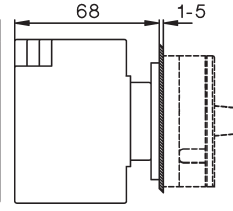
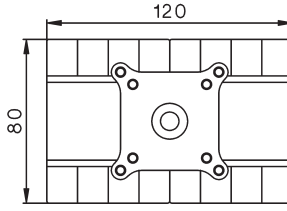

**LS... +VW"x"**  
 Extended Switch Shaft

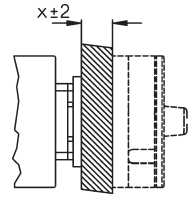

**LS40 E.., LS55 E.., LS65E..**  
**..A2, ..A2+2, ..A4.**

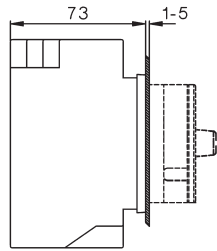
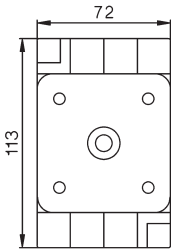

**LS40 E.., LS55 E.., LS65E..**  
**..A6, ..A8, ..A3+2, ..A4+2**

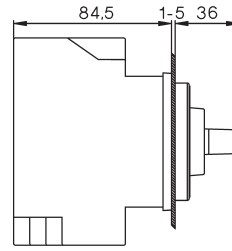
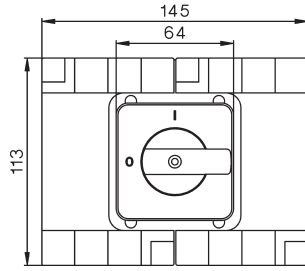

Mounting hole  
 Mounting screw:  
 S3631N M=1,2-1,4 Nm

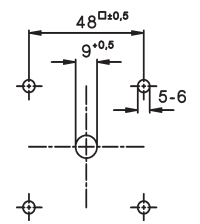

### Escutcheon plate 64<sup>□</sup>

Handle

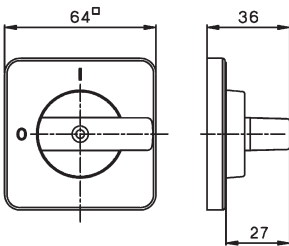

Padlock device SV1.

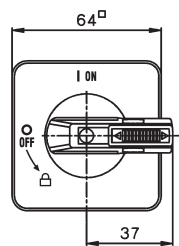

Padlock device SV4.

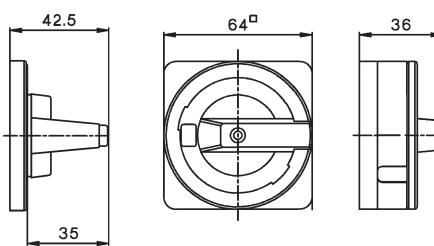

**LS16 Z.., LS25 Z.., LS32 Z.., LS38 Z..**  
**..A2**

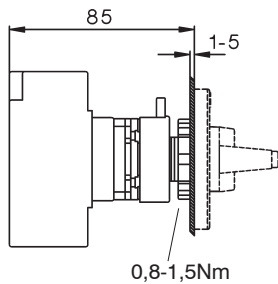
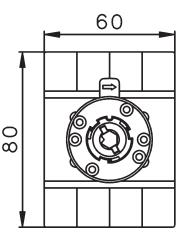

**..A2+2, ..A4.**

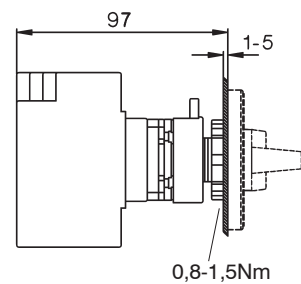
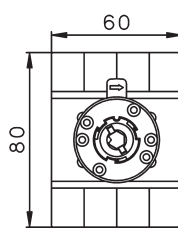

Mounting hole

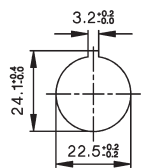

### Escutcheon plate 48<sup>□</sup>

Handle

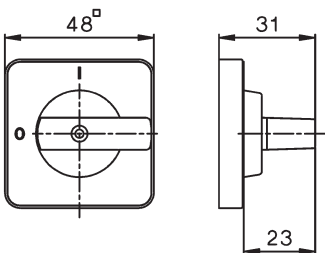

Padlock device SV1.

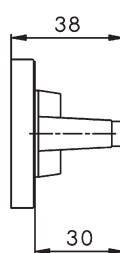
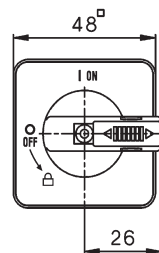

## Dimensions

**LS16 Z., LS25 Z., LS32 Z., LS38 Z.**  
**..A6, ..A8, ..A3+2, ..A4+2**

**LS.. ZO..**

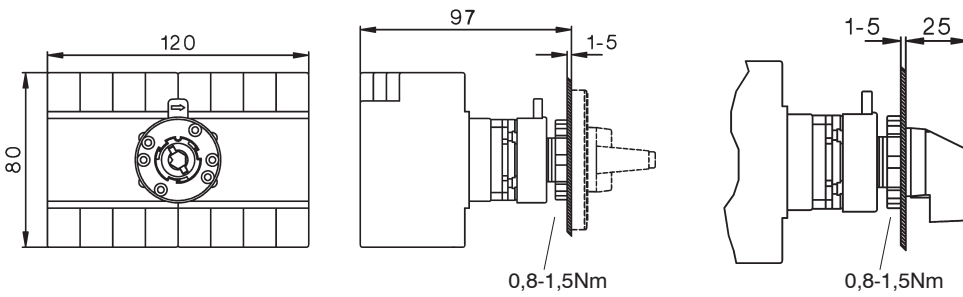

**LS16 VZV., LS25 VZV., LS32 VZV., LS38 VZV.**  
**..A2, ..A2+2, ..A4**

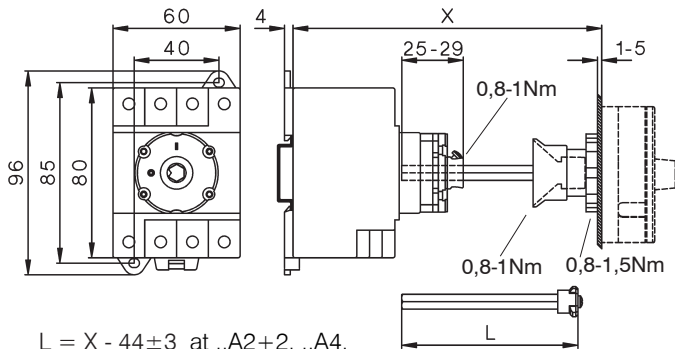

delivered with: ..A2+2, ..A4.

$X_{max.} = 194, L = 150$

( $X_{min.} = 89$ )

delivered with: ..A2

$X_{max.} = 182, L = 150$

( $X_{min.} = 77$ )

Bigger X-Dimensions on request

$L = X - 44 \pm 3$  at ..A2+2, ..A4.

$L = X - 32 \pm 3$  at ..A2

**LS16 VZV., LS25 VZV., LS32 VZV., LS38 VZV.**  
**..A6, ..A8, ..A3+2, ..A4+2**

Mounting hole

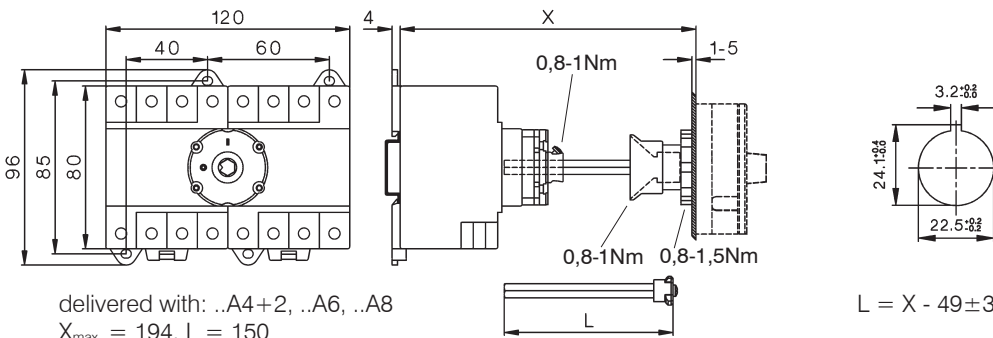

delivered with: ..A4+2, ..A6, ..A8

$X_{max.} = 194, L = 150$

( $X_{min.} = 95$ )

$L = X - 49 \pm 3$

**LS40 VZV., LS55 VZV., LS65 VZV.**  
**..A2, ..A2+2, ..A4.**

**LS40 VZV., LS55 VZV., LS65 VZV.**  
**..A6, ..A8, ..A3+2, ..A4+2**

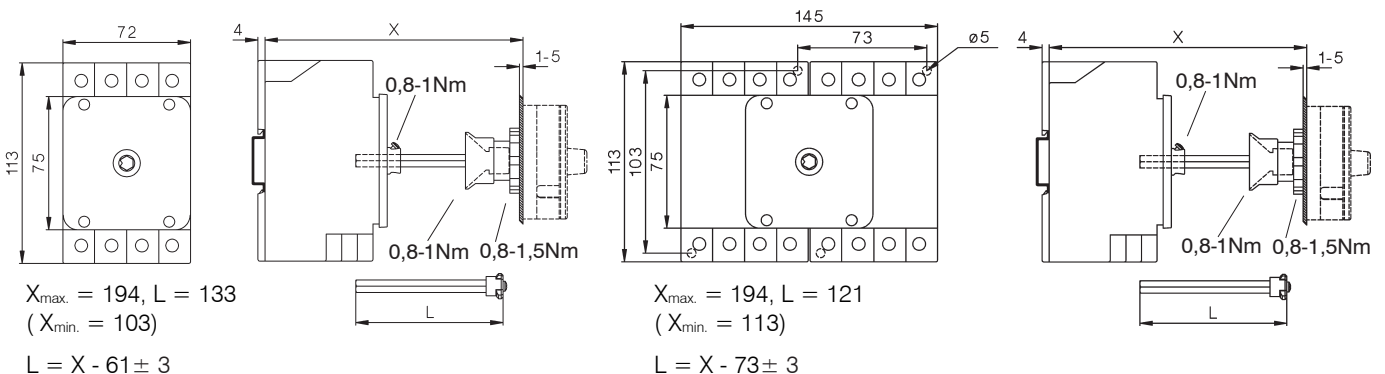

$X_{max.} = 194, L = 133$

( $X_{min.} = 103$ )

$L = X - 61 \pm 3$

$X_{max.} = 194, L = 121$

( $X_{min.} = 113$ )

$L = X - 73 \pm 3$

# Dimensions

**LS16 SMA..., LS25 SMA..., LS32 SMA..., LS38 SMA..  
..A2**

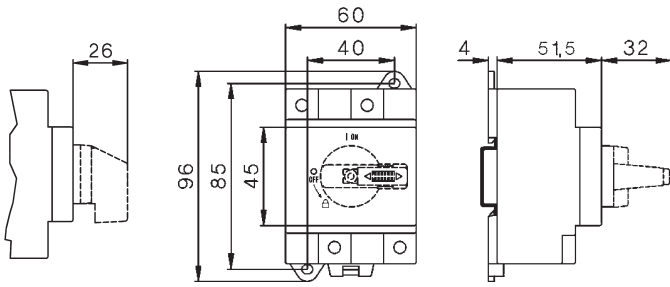

**..A2+2, ..A4**

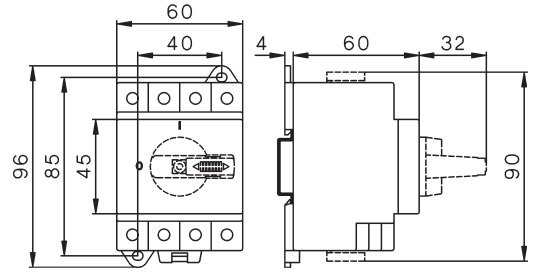

**LS40 SMA..., LS55 SMA..., LS65 SMA..  
..A2, ..A2+2, ..A4**

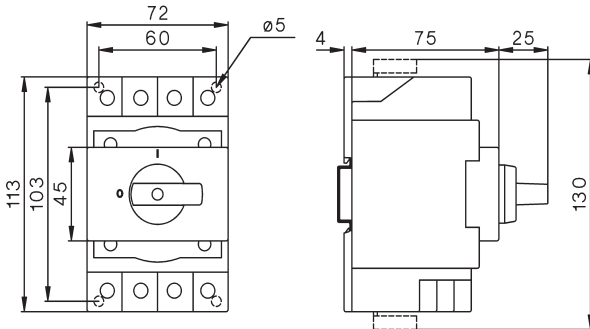

**LS40 SMA..., LS55 SMA..., LS65 SMA..  
..A6, ..A8, ..A3+2, ..A4+2**

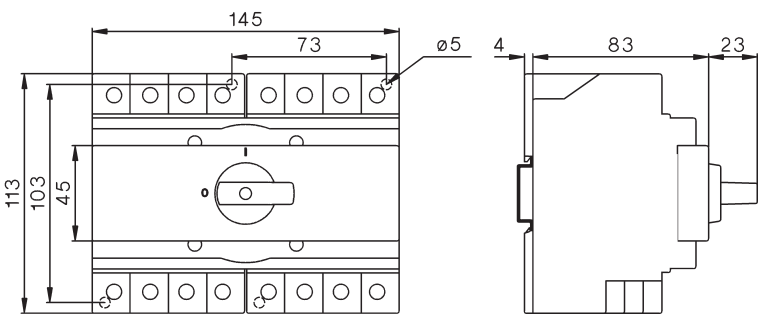

**LS16 SMA..., LS25 SMA..., LS32 SMA..., LS38 SMA..  
..A6, ..A8, ..A3+2, ..A4+2**

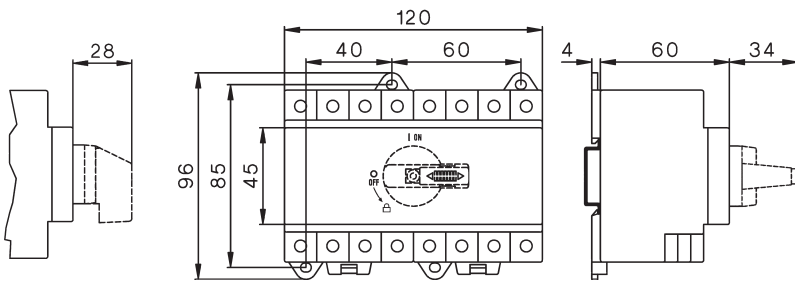

**LS.. SMAH1.. with low height handle  
A2 +SV1N**

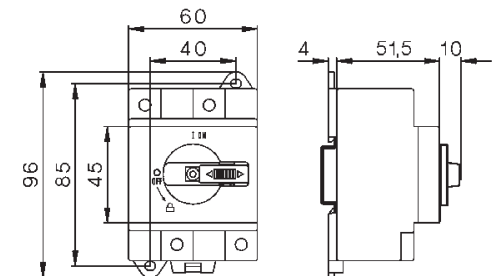

**LS16 SMAH1..., LS25 SMAH1..., LS32 SMAH1..., LS38 SMAH1.. with low height handle  
A2+2 +SV1N, A4 +SV1N**

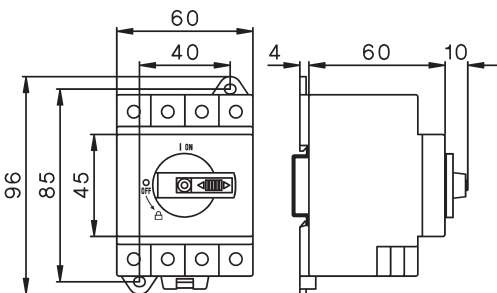

**A4+2 +SV1N, A6 +SV1N, A8 +SV1N**

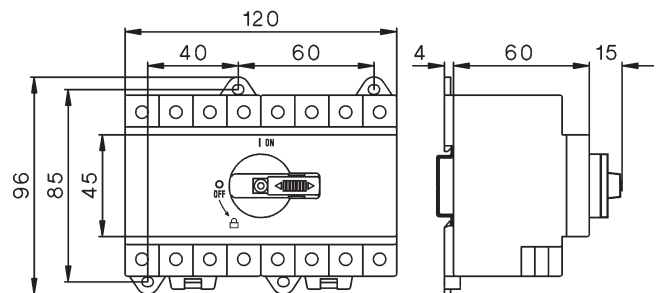

## Dimensions

LS16 PFL..., LS25 PFL..., LS32 PFL..., LS38 PFL..  
..A2, ..A2+2, ..A4.

Main-Switch (lockable)  
LS..PFLH4 A..

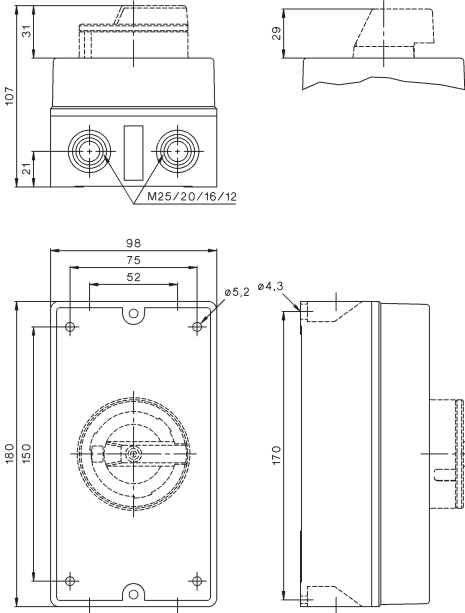

LS16 PFL..., LS25 PFL..., LS32 PFL..., LS38 PFL..  
..A2, ..A2+2, ..A4.  
+ M25

Main-Switch (lockable)  
LS..PFLH4 A..

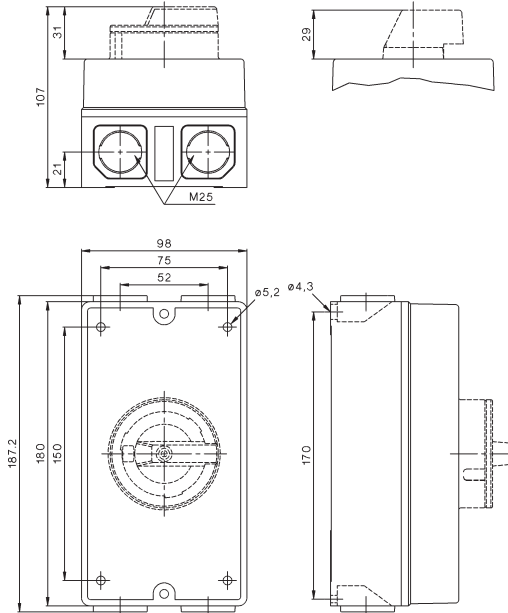

LS16 PFL..., LS25 PFL..., LS32 PFL..., LS38 PFL...,  
..A2, ..A4, ..A6, ..A8, ..A2+2, ..A3+2, ..A4+2  
LS40 PFL..., LS55 PFL..., LS65 PFL..  
..A6, ..A8, ..A3+2, ..A4+2

Main-Switch (lockable)  
LS..PFLH4 A..

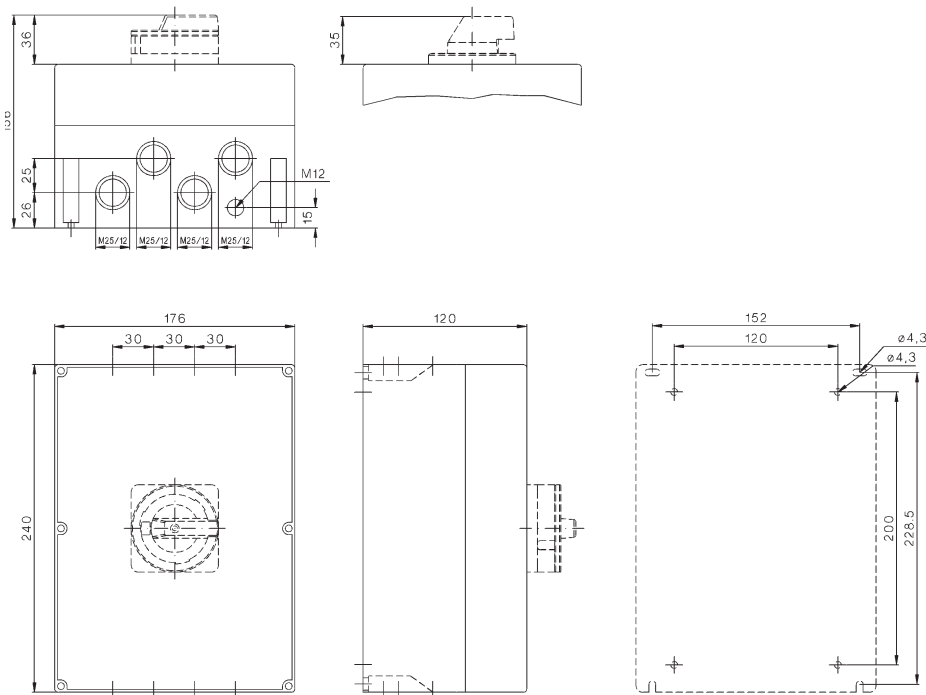

## Dimensions





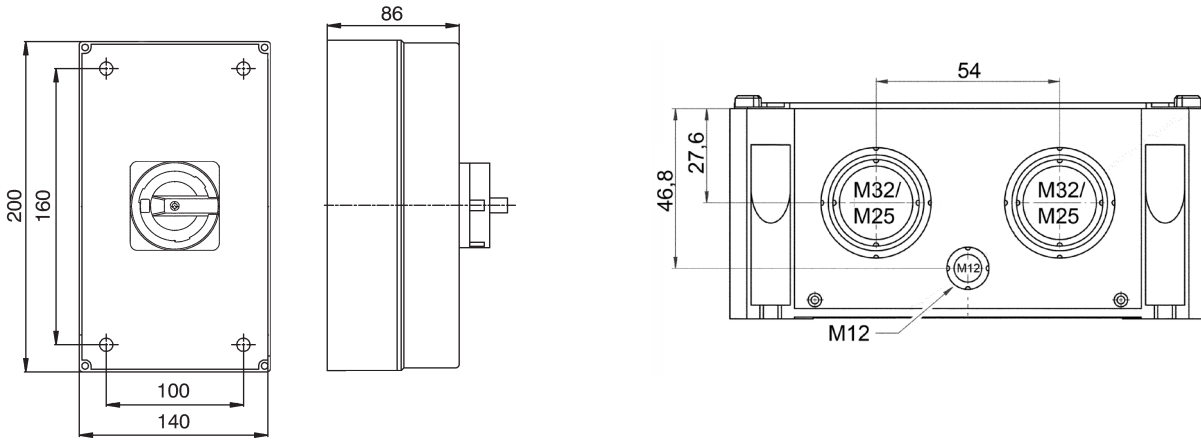



LS40 PFL..., LS55 PFL..., LS65 PFL..  
..A2, ..A4, ..A2+2

Main switch (lockable)  
LS..PFLH4 A.. +PF2 (small enclosure)



## Insulated jumpers LSV... for series- and parallel switching of contacts:

for switches	Type	Pack	Weight
LS16, LS25, LS32, LS38	LSV-B1-1	100	7,0 g/pcs.
LS16, LS25, LS32, LS38	LSV-B1-2	100	12,0 g/pcs.
LS40, LS55, LS65	LSV-B2-1	100	9,0 g/pcs.
LS40, LS55, LS65	LSV-B2-2	100	17,0 g/pcs.

Typ	LS16	LS25	LS32	LS38	LS40	LS55	LS65
A40 A4U A4B	2 x  LSV-B1-1 N		2 x  LSV-B1-2 N		2 x  LSV-B2-2 N		
A2+2	4 x  LSV-B1-1 N				4 x  LSV-B2-1 N		
A4+2	8 x  LSV-B1-1 N				8 x  LSV-B2-1 N		
	2 x  LSV-B1-2 N				2 x  LSV-B2-2 N		

Applications:

LS16-38 VZV.. A2+2

LS16-32 VZV.. A40

LS38 VZV.. A40

LS16-38 VZV.. A4+2

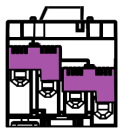

2x LSV-B1-1



4x LSV-B1-1

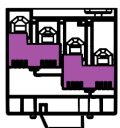
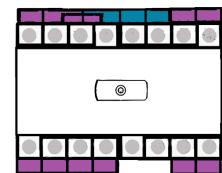
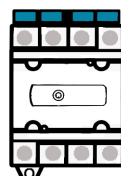
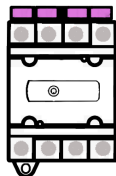
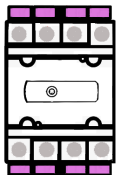

2x LSV-B1-1



2x LSV-B1-1

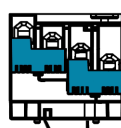

2x LSV-B1-2

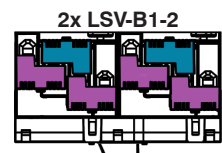

2x LSV-B1-2

4x LSV-B1-1

LS40-65 VZV.. A2+2

LS40-65 VZV.. A40

LS40-65 VZV.. A4+2



2x LSV-B2-1

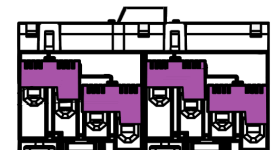

4x LSV-B2-1

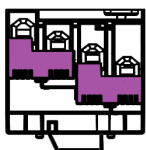
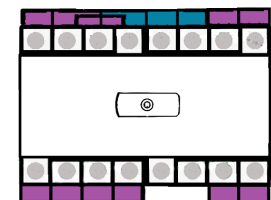
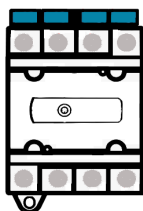
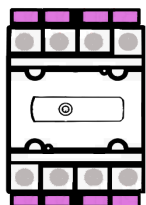

2x LSV-B2-1

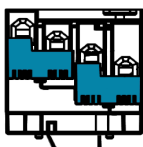

2x LSV-B2-2

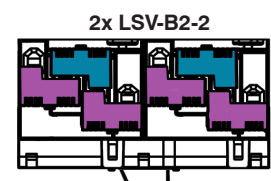

2x LSV-B2-2

4x LSV-B2-1

Further applications for switches LS16.. to LS65.. please find under [www.benedict.at](http://www.benedict.at) (Button "Certificates/Declarations").