

Operating instructions

C50 rack conveyor warewasher

(Original operating instructions)



Basic machine with single rinse and a pass-through direction of "left-right".
Optional machine versions can be found on page 8. The table system and accessories such as racks are not included in the scope of delivery of the machine.



Contents

1	About this manual	2
2	Proper use	2
3	Safety notes	3
4	Before working with the machine	5
5	Mode of operation	6
6	Overview	6
7	Curtain plan	7
8	Machine versions	8
9	Operating panel and display	9
10	Menu levels	10
11	PIN Menu	11
12	Rinse aid and detergent	13
13	Before switching on the machine	15
14	Switching on the machine	15
15	Washing	16
16	Exchanging the tank water	18
17	Malfunctions	19
18	Servicing and maintenance	21
19	Fast drainage programme	25
20	Decommissioning the machine for a period of disuse	25
21	Recommissioning the machine after a period of disuse	25
22	External dosing devices	26
23	Installing the machine and tables	28
24	Location of the connections on the machine	29
25	Water connection	29
26	Electrical connection	30
27	Technical data	33
28	Emissions	33





1 About this manual

This manual contains information and instructions for the safe operation and maintenance of your dishwasher.



Only use the warewasher after you have read and understood the operating instructions and the safety notes.

The following symbols are used in these instructions:

Symbol	Meaning
 Danger	Warning against potential serious or fatal injuries to persons if the described precautionary measures are not taken.
 Warning	Warning against potential minor injuries to persons or potential material damage if the described precautionary measures are not taken.
 Caution	Warning against defects in or destruction of the product if the described precautionary measures are not taken.
	Carefully read through the safety notes and operating instructions in this manual before working with this machine.
IMPORTANT	Important information is given here.
INFO	Useful information is given here.
➤	This symbol indicates instructions.
⇒	This symbol indicates results of your actions.
–	This symbol indicates itemizations.
▶	This symbol refers to a chapter with more detailed information.

Proper use

- This warewasher is a technical device for commercial use and is not intended for private use.
- Use the warewasher only for the washing of dishes such as plates, cups, cutlery and trays or for washing glasses of a gastronomic and related type.
- Always operate the machine as described in the operating instructions.
- Winterhalter Gastronom GmbH does not assume liability for any damage caused due to improper use of the warewasher.

Improper use

- The water in the warewasher may not be used as drinking water.
- Do not wash without a wash rack.
- Do not make changes, additions or reconstructions in the warewasher without the approval of the manufacturer.

3 Safety notes

General safety notes

- This machine can be used by children aged from 8 years and above and persons with reduced physical, sensory or mental capabilities, or lack of experience and knowledge, if they have been given supervision or instruction concerning use of the machine in a safe way and understand the hazards involved.
- Children shall not play with the machine.
- Cleaning and user maintenance shall not be made by children without supervision.
- Read through the safety notes and operating instructions in this manual carefully.
- Retain the operating instructions for future reference.
- Only use the warewasher after you have read and understood the operating instructions.
- Allow the Winterhalter Customer Service Department to provide information about the operation and functioning of the warewasher.
- Train the operating personnel as regards handling the machine and inform them about the safety notes. Repeat the training sessions at regular intervals to prevent accidents.
- Operate this machine only when it is in perfect condition.
- A damaged or leaking machine may endanger your safety. In case of defects, switch off the machine immediately. Do not switch the machine on until the defect has been rectified. Switch off the local mains disconnecter (main switch). Only then is the machine without power.
- Contact your installer or electrician if the on-site water or electricity supply is the cause of the malfunction.
- Contact an authorised service technician or your retailer if any other fault has occurred.
- Close the on-site water supply after the work is complete.

- Switch off the on-site mains disconnecter after the work is complete.

Electrical Safety

- The electrical safety of this machine is guaranteed only if it is connected to a correctly installed protective circuit and a residual current circuit breaker. It is crucial that this basic safety requirement is tested and, in case of doubt, that the house installation is checked by a qualified electrician.
Winterhalter cannot be held responsible for damage caused by a missing or broken protective conductor (e.g. electrical shock).
- Do not open any machine covers or machine parts if it requires tools. There is danger of shock.
- For your safety, test the on-site residual current circuit breaker (FI) regularly by pressing the test button.

Maintenance and repair work

- Maintenance work and repairs may only be performed by authorised Winterhalter service technicians. Improper maintenance or repairs may cause significant danger for the user, for which Winterhalter is not liable.
- Disconnect the machine from its power source during maintenance and repair work. Electricity consumers (heating element) are under voltage until the local mains disconnecter has been operated.
- Only original Winterhalter spare parts may be used for maintenance and repairs. If original spare parts are not used, the warranty is invalidated.
- If the mains cable of this machine is damaged, it must be replaced by the Winterhalter or its Customer Service or another qualified person in order to prevent hazards. The mains cable must be an oil-resistant, encased and flexible wire. The wire type H07RN-F is recommended.

4 Before working with the machine

- Have the machine set up by an authorised service technician or your dealer.
- Have the machine connected as per the locally applicable standards and the regulations of the authorised mechanics (water, waste water, electrical system).
- After connecting the water and the power properly, contact the relevant Winterhalter dealer or your dealer for the commissioning of the machine and for providing training in its operation. Have yourself and your operating personnel trained in the operation of the machine.

5 Mode of operation

After the machine is switched on, the boiler and the tank are filled and warmed up to the operating temperature. Once the operating temperatures are reached, the machine is ready for use. The wash racks are transported through the machine by means of push bars.

6 Overview

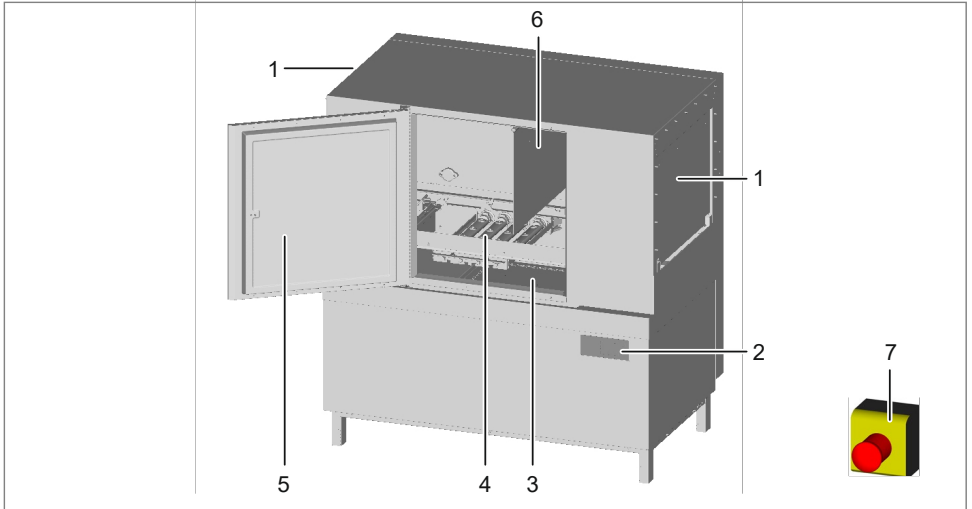

Figure: Basic machine with single rinse and a pass-through direction of “left-right”.
Optional versions can be found on page 8.

Item	Description
1	Long curtain (length: 520 mm)
2	Display
3	Strainer
4	Wash arms (top: 5; bottom: 4)
5	Door
6	Short curtain (length: 420 mm)
7	Emergency-stop button (optional)

INFO Machines with dual rinse additionally have a strainer and two wash arms in the rinse zone.
Machines with a pre-cleaning zone have 2 additional wash arms and a long curtain.

Emergency-stop button

Function

Pushing the emergency-stop button disconnects the control phase to the mainboard and to the frequency inverter. The rack conveyor is stopped and the machine is shut off. The machine is not disconnected from the mains network.

Position

The position of the emergency-stop button must be determined on-site. The emergency-stop button must be connected to the machine (see the circuit diagram).

7 Curtain plan

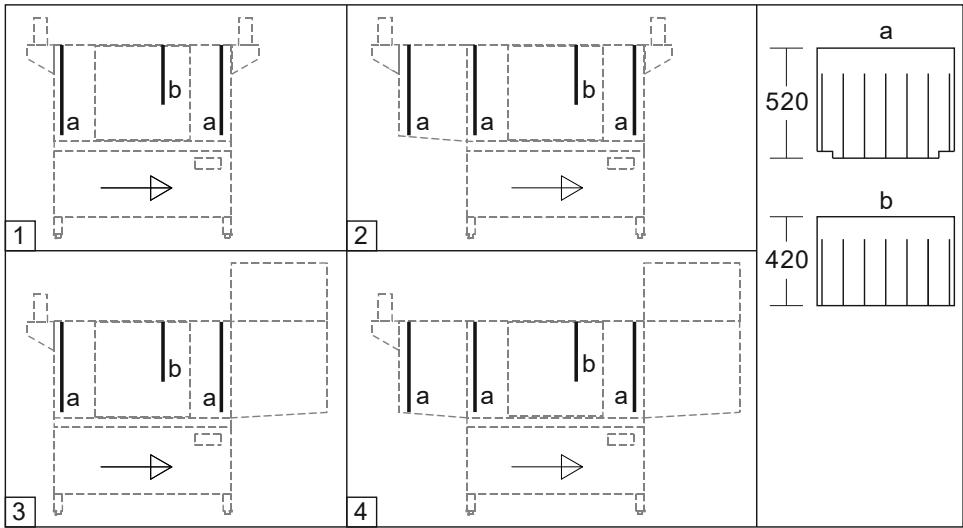

 The pass-through direction shown here is “left-right”.
 On machines with pass-through direction “right-left” the position of the curtains is mirror-inverted.

1	C50 (basic machine)
2	C50 with pre-cleaning zone
3	C50 with drying zone
4	C50 with pre-cleaning zone and drying zone

8 Machine versions

With single rinse

With dual rinse

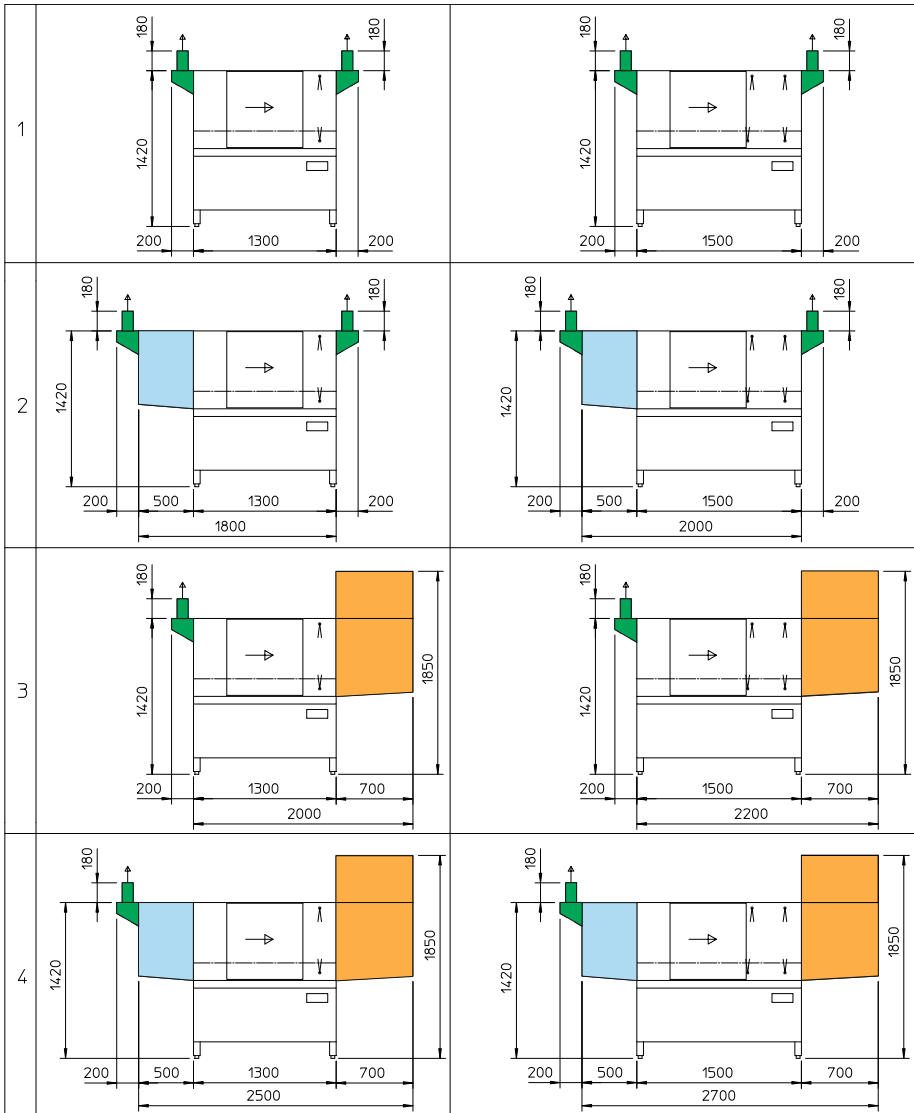

		Number of exhaust air vents (optional)
1	C50 (basic machine)	1 or 2
2	C50 with pre-cleaning zone	1 or 2
3	C50 with drying zone	1
4	C50 with pre-cleaning zone and drying zone	1

9 Operating panel and display

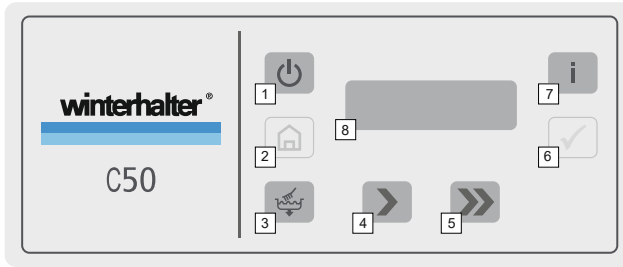

Item	Description
1	On/Off button
2	Home button (PIN Menu)
3	Drainage programme
4	Starting/stopping the rack conveyor <ul style="list-style-type: none"> – Briefly press: Standard programme Pictogram (>) lights up in the display. Press again: Stops the programme – Press and hold: Intensive programme Pictogram (>) flashes in the display. Press again: Stops the programme
5	Starting/stopping the rack conveyor <ul style="list-style-type: none"> – Briefly press: Rapid programme Pictogram (>>) lights up in the display. Press again: Stops the programme
6	Confirmation button
7	Info button
8	Display

Display colours during normal operation

Colour	Meaning
red	Machine is filling and heating up.
green	Machine is ready for use.
blue	Machine is washing. The rack conveyor is running.

Display colours in the event of an error

Colour	Meaning
yellow	Washing is still possible, depending on the error maybe only to a limited extent.
red	Washing is no longer possible. Machine stops.

10 Menu levels

The following levels are available:

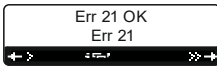
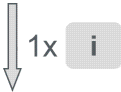
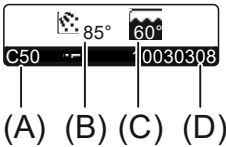

Main level

The preselected rack conveyor speed or error pictograms will appear in the display (► 17).

Info level

(A)	Machine name
(B)	Temperature in the boiler
(C)	Temperature in the main washing tank
(D)	Machine serial number

Error memory

All errors with an error code are saved in the error memory. The error that occurred last is displayed first.

You can go through the list using the ► and ►► buttons.

Display	Explanation
ERR xx	Malfunction
ERR xx OK	Malfunction resolved
ON ↑	Machine ON





Access to the PIN Menu

In the PIN menu you can programme the terminal strip for the connection of an external dosing device (► 22).





Further functions see (► 11).

11 PIN Menu

Explanation of the buttons

Button	Function
	Cursor left or reduce value
	Cursor right or increase value
	Confirm
	Back
	Briefly press: Back Press and hold: Jump to main level

Accessing the PIN Menu





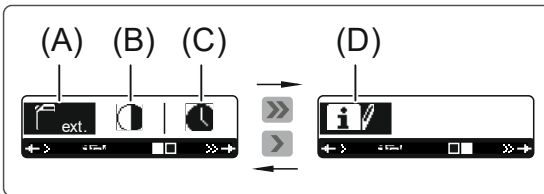

	<ul style="list-style-type: none"> ➤ Press the  button three times. <ul style="list-style-type: none"> ⇒ The PIN input mask is displayed. ➤ Enter PIN 1575. To do this, select the individual figures with the  or  button and confirm each figure with the  button.
--	--

Overview



























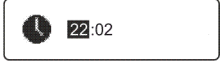

(A)	Parameters for external dosing devices (▶ 22)
(B)	Contrast
(C)	Date/time
(D)	Operating data (water consumption and operating hours)



Contrast



	<p>= Start screen</p> <ul style="list-style-type: none"> ➤ Confirm with the  button. <ul style="list-style-type: none"> ⇒ The whole display becomes black. ➤ Set the contrast with the  or  button. ➤ Confirm with the  button.
	

Date and time

	<p>= Start screen</p> <ul style="list-style-type: none"> ➤ Confirm with the  button. 				
	<ul style="list-style-type: none"> ⇒ The current date (YYYY-MM-DD) and time are shown. ➤ If date and time are correct, leave the menu by briefly pressing the  button. ➤ Otherwise press the  button. 				
	<ul style="list-style-type: none"> ⇒ The current date is shown. ➤ If necessary, change the date. The inverted part can be edited. Change the value by pressing the following buttons: 				
	<table border="1"> <tr> <td data-bbox="383 466 554 507">  +  </td> <td data-bbox="565 466 1019 507">Reduce / increase value</td> </tr> <tr> <td data-bbox="383 507 554 545">  </td> <td data-bbox="565 507 1019 545">Confirm + next part</td> </tr> </table>	 + 	Reduce / increase value		Confirm + next part
 + 	Reduce / increase value				
	Confirm + next part				
	<ul style="list-style-type: none"> ⇒ The current time is shown (24 h mode). ➤ If necessary, change the time. The inverted part can be edited. Change the value by pressing the following buttons: 				
	<table border="1"> <tr> <td data-bbox="383 689 554 730">  +  </td> <td data-bbox="565 689 1019 730">Reduce / increase value</td> </tr> <tr> <td data-bbox="383 730 554 769">  </td> <td data-bbox="565 730 1019 769">Confirm + next part</td> </tr> </table>	 + 	Reduce / increase value		Confirm + next part
 + 	Reduce / increase value				
	Confirm + next part				

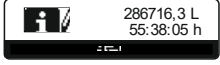
Operating data

	<p>= Start screen</p> <ul style="list-style-type: none"> ➤ Confirm with the  button.
	<p>The following data are shown:</p> <ul style="list-style-type: none"> - Total water consumption - Operating hours with activated rack conveyor - Total time when machine is switched on

You can go through the list using the  and  buttons.

12 Rinse aid and detergent



Danger

Possible risk of chemical burn

- Wear protective clothing, protective gloves and protective goggles when handling chemicals.
- When handling chemicals, observe the safety notes and the recommended dosage on the packaging.



Caution

- Use only products that are suitable for commercial warewashers.
- Do not use products that can create foam.
- Do not fill rinse aid in the container for detergent and vice versa.

Changing the chemical product



Caution

Possible risk of damage to the dosing device

- Do not mix different products.
- Crystallisation can destroy the dosing device and clog the hoses.

As a rule, a new product requires that the dosing device be rinsed with water and re-configured.

- To attain good wash results, assign the required work to an authorised service technician.

If this is not done, the Winterhalter Gastronom GmbH warranty and product liability will be void.

Rinse aid

A rinse aid is necessary to ensure that water on the dishes drains off after washing and dries off after a short while.

Detergent



Caution

- Do not use acidic detergents.
- Do not use any foaming products (e.g. hand wash) for treating the items to be washed as these will build up in the machine.

A detergent is necessary to ensure that the leftovers and dirt on the wash items are cleaned.

Dosing devices

Rinse aids and detergents must be dosed using external dosing devices. Dosing devices are not included in the scope of delivery of the machine.

Connection of external dosing devices: ► 22.

Suction tube with level control



Caution

- Only use the suction tube with sufficiently stable containers. Narrow and tall containers can tip if the suction tube is pulled.
- Do not place the suction tube for the rinse aid in the container with detergent or vice versa.
- Do not pull unnecessarily on the suction hose or main power cable, as this may lead to a defect.

As an option with your machine you may have one or more suction tubes with level control:



Colour of the cap	Colour of the hose	Container
blue	blue	Rinse aid
black	transparent	Detergent

Changing the container (same product)



Danger

Possible risk of chemical burn

Wear protective clothing, protective gloves and protective goggles when handling chemicals.



- Clean the suction tube under running water.
- Ensure that both vent holes (1) in the cap are open.
- Place the suction tube in the new container.
- Slide the cap downwards until the container opening is closed.

13 Before switching on the machine

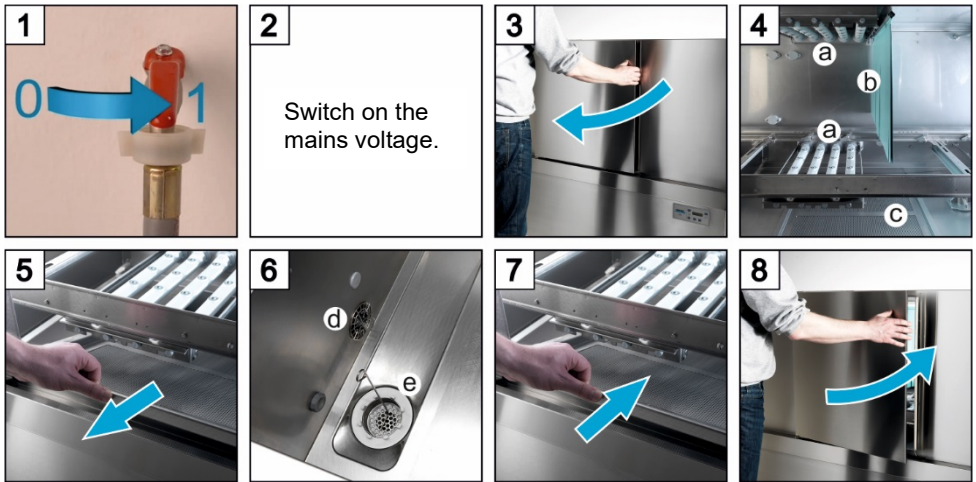

➤ Check, that the following parts are inserted:

- Wash arms (4a)
top: 5; bottom: 4
- Curtains (4b)
Follow the curtain plan (► 7)
- Strainer (4c)
- Pump inlet filter (6d)
- Drain filter (6e)

INFO Machines with dual rinse additionally have a strainer and two wash arms in the rinse zone.
Machines with a pre-cleaning zone have 2 additional wash arms and a long curtain.

IMPORTANT Ensure that there is always enough detergent and rinse aid available to achieve an optimum wash result at all times.

14 Switching on the machine

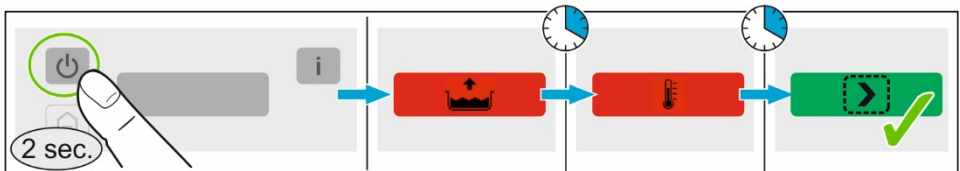

15 Washing



Warning

Possible risk of scalding from hot lye-mixed water

- Keep children away from the warewasher. The lye-mixed water is at a temperature of approx. 62 °C (HighTemp: 73 °C).
- Do not open the door while the machine is washing. There is a risk of the hot wash water spilling out. Stop the washing programme before doing so.

Possible risk of injury

- Arrange sharp, pointed utensils so that they do not cause injury.
- Do not reach into the inside of the machine either at the inlet or outlet end while washing.



Caution



- Do not use the warewasher to wash electrically heated devices or parts made of wood.
- Do not wash parts made of plastic if they are not heat and lye-resistant.
- Only wash parts made of aluminium such as pots, containers or trays with a specially suitable detergent, to avoid black discolourations.

Preparing the items being washed

- Remove larger traces of food and waste from the wash items.
- Pre-rinse the dishes with cold water.
- Drain off liquid residues.

Starting the rack conveyor

- Press the  or  buttons.

Button	Rack conveyor speed	Soiling of the dishes
	moderate (briefly press the button)	normal
	low (press and hold the button)	severe
	high	slight

- ⇒ The rack conveyor starts and the circulating pump and rinse switch on.

- Slide the wash rack into the machine.
Plate top oriented towards the front.

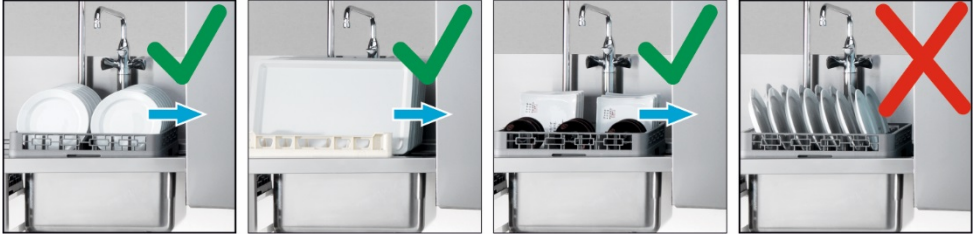

For machines with a corner inlet:

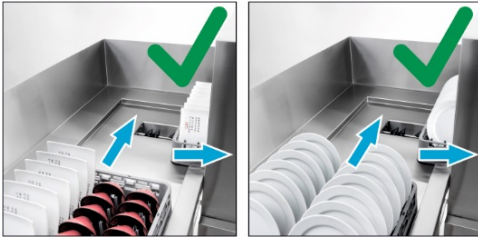

- Do not overfill the wash racks.



INFO If you wait longer than approx. 2 minutes to insert a rack, first the circulating pump and then the rinse shut off. The rack conveyor shuts off after approx. 7 minutes. The washing process restarts when the rack is inserted.

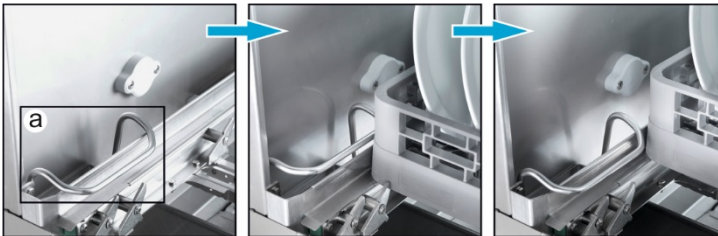

a: Rack switch

Removing the wash racks from the outlet table

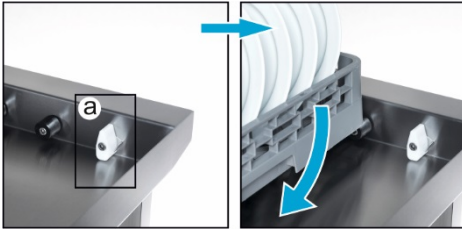

a: Table limit switch on the Winterhalter outlet table

- Remove the wash rack from the outlet table before the table limit switch is actuated (Image 2).

INFO The table limit switch stops the rack conveyor and prevents a blockage if the racks are not removed from the outlet table.

IMPORTANT The outlet table must be equipped with a table limit switch. The table limit switch must be connected to the machine (see circuit diagram).

Terminating the rack conveyor

- Press the button for the selected rack conveyor speed.

Wash breaks

Do not switch the machine off during wash breaks in order to prevent cooling off.

Switching the machine off

Switch off the machine at the end of the working day using the drainage programme (► 18), so that it is cleaned and emptied every day.

16 Exchanging the tank water

If the water in the tank is very dirty, it can be easily exchanged.

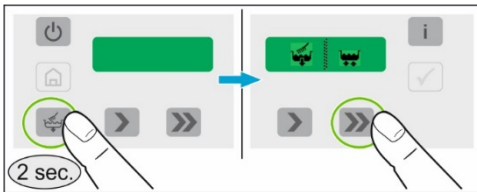

⇒ Tank of the machine is first completely emptied, then refilled and heated.

Terminating the tank water exchange



- Press the button.
 - ⇒ The tank of the machine is refilled and heated.

17 Malfunctions

Malfunctions are shown in the display in the form of pictograms. With some malfunctions washing is still possible, however, the wash result will be impaired. Therefore resolve any malfunction as soon as possible.



Category 1 malfunction

- Resolve the malfunction.
 - ⇒ Display turns green.
- Washing is then possible without restriction.



Category 2 malfunction

- Press the button.
- If the malfunction is still present, the display lights up yellow. Certain components are switched off to protect against further damage. Washing is possible to a limited extent after pressing the button.
- Read the error code and contact an authorised service technician for the repair.









Category 3 malfunction

- Read the error code and contact an authorised service technician for the repair.
- Washing is not possible without repair.

Pictogram	Cause/meaning	Remedy
	Lack of water or uncontrolled water supply	Open the on-site water supply.
		Have the dirt trap cleaned by a service technician or have a new dirt trap installed.
		Contact an authorised service technician.
	Door was opened at an inadmissible time (e.g. during washing)	Close the door.
	Detergent container is empty ¹	Change the detergent container.
	Rinse aid container is empty ¹	Change the rinse aid container.

¹ is only displayed, when a suction tube with level control is connected to the machine

Pictogram	Cause/meaning	Remedy
	Table limit switch actuated	Remove the wash rack from the outlet table.
	Rack conveyor is blocked	Remove the block (e.g. jammed dishes).
	Water drain is blocked or drain pump is defective	Contact an authorised service technician.
	Strainer in the tank is clogged. Machine goes into standby.	Remove, clean and re-insert the strainer. Press the  or  button to restart the rack conveyor.

Poor cleaning result

INFO The water quality affects the washing and drying performance. We therefore recommend from a total hardness of more than 3° dH (0.53 mmol/l) that the machine is supplied with softened water.

	Possible Cause	Remedy
The dishes do not get clean	No or low detergent dosing	Contact an authorised service technician to set the dosing amount.
		Check dosing hose (for kinks, breakage, ...) Replace the storage container if empty.
	Dishes incorrectly sorted	Do not stack dishes one over the other.
	Jets of the wash arms blocked	Remove the wash arms and clean the jets.
	Temperatures are too low	Check temperatures (► 10)
There is formation of layers on the dishes	In case of limescale deposits: The water is too hard	Check external water treatment.
	In case of starch residues: Excessively high temperatures during manual pre-cleaning (hand shower)	The temperature of the manual pre-wash should be a maximum of 30 °C

	Possible Cause	Remedy
The dishes do not dry on their own	No or low rinse aid dosing	Contact an authorised service technician to set the dosing amount. Check dosing hose (for kinks, breakage, ...) Replace the storage container if empty.
	Rinse temperature is too low	Contact an authorised service technician to set the temperature.

18 Servicing and maintenance

The following materials must **not** be used for cleaning:

- detergents containing chlorine or acid
- foaming products
- cleaning sponge or wire brush containing metal
- abrasives or abrasive cleaning agents



Warning

- Do not spray the machine and the surrounding area (panels, base) using a water hose, steam-jet air ejector or high-pressure cleaner.
- Ensure that the base of the machine is not flooded when cleaning the floor in order to prevent an uncontrolled inflow of water.



Warning

Wear protective clothing and protective gloves before touching parts in contact with wash water (curtains, filters, wash arms, etc.).



Caution

Ensure that there are no rusty foreign objects in the machine which could cause even the "stainless steel rust-free" material to start rusting. Rust particles can come from non-rust-free wash items, cleaners, damaged wire racks or non-rust-protected water lines.

Cleaning the strainer

➤ Regularly clean the strainer during the working day.



Additionally for machines with dual rinse

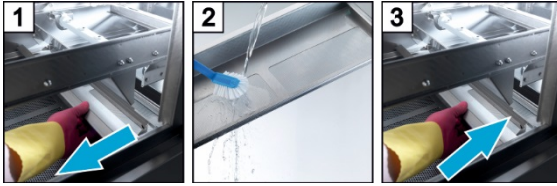

Cleaning the air baffle

INFO Only for machines with exhaust air vents

➤ Clean the air baffle at the end of the working day.

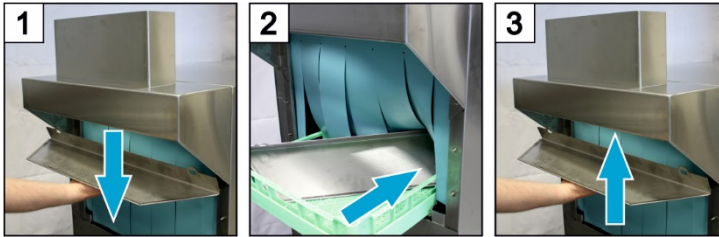

Drainage programme

➤ Switch off the machine daily using the drainage programme.

1

2

3

4

5

6

7

8

9

10

11

12

13

14

15

16

17

18

19

20

21

22

23 **IMPORTANT**
Check, that there is no water in the tank.

24

25

- Re-insert the filters and wash arms.
- Re-insert the curtains.
- Follow the curtain plan (▶ 7).

Additionally for machines with dual rinse



- Remove and clean the strainer and wash arms.
- Re-insert the strainer and wash arms after cleaning.
When inserting the wash arms, pay attention to the different jets.
5a: Wash arm in the rinse zone
5b: Wash arm in the main wash zone / pre-cleaning zone

Additionally for machines with pre-cleaning zone

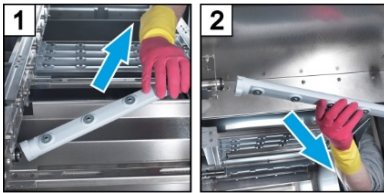

- Remove and clean wash arms.
- Re-insert the wash arms after cleaning.

Terminating the drainage programme



- Press the button.
⇒ The tank of the machine is refilled and heated.

Cleaning the outside of the machine

- Clean the operating panel and display with a moist cloth.
- Clean the external surfaces using a stainless steel cleaner and stainless steel polish.

After cleaning

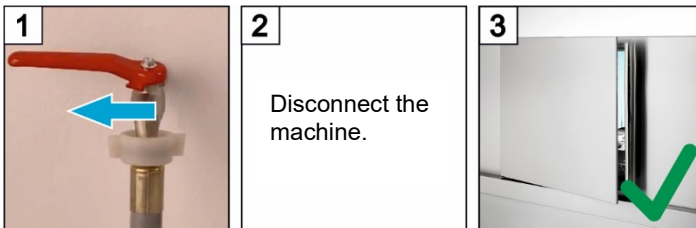

19 Fast drainage programme

Using the fast drainage programme the machine is only drained. As soon as the machine is drained, it switches off automatically.

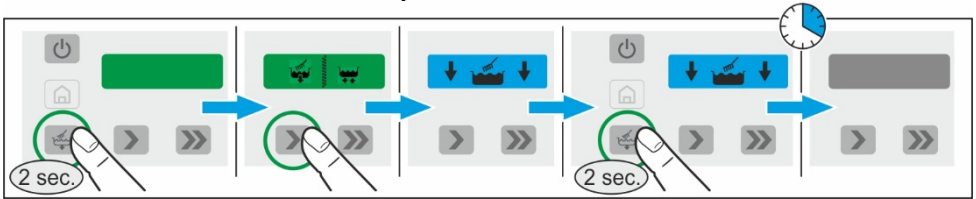

20 Decommissioning the machine for a period of disuse

If the machine needs to be out of operation for a long duration (holidays, seasonal business), proceed as follows:

- Empty the machine using the drainage programme (► 18).
- Clean the machine (► 18).
- Leave the door open.
- Close the on-site water supply.
- Switch off the local mains disconnector.
- Store detergent and rinse aid containers frost-free.

If the machine is in a place that is not frost-free:

- Instruct an authorised service technician to make the machine frost-resistant.

21 Recommissioning the machine after a period of disuse

After extended periods of disuse, proceed as follows:

- Open the on-site water supply.
- Reinstall detergent and rinse aid containers.
- Switch on the local mains disconnector.
- Switch on the machine.

If the machine was in a place that was not frost-free:

After extended periods of disuse, the machine must be completely climatised (at least 24 hours at 25 °C). If this requirement is met:

- Contact an authorised service technician to put the machine back into service.

22 External dosing devices



Danger

Danger to life. Live components.

Get the dosing devices installed and commissioned by an authorised service technician.

Terminals

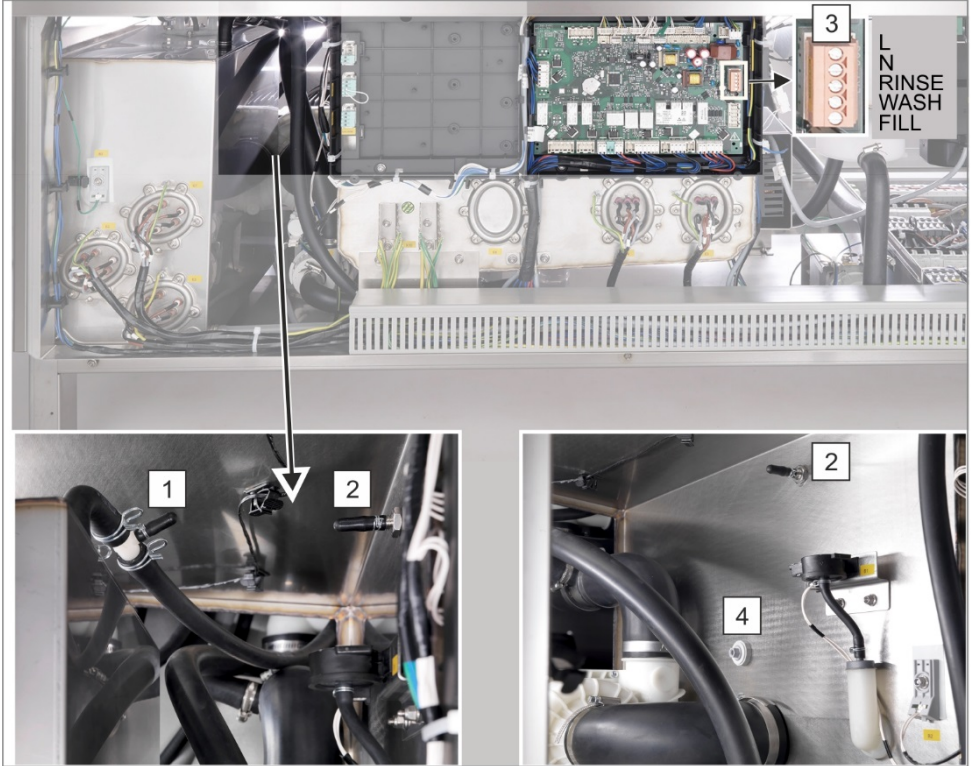

Item	Description
1	Rinse aid dosing point
2	Detergent dosing point
3	Transfer strip
4	Drill hole for conductivity electrode

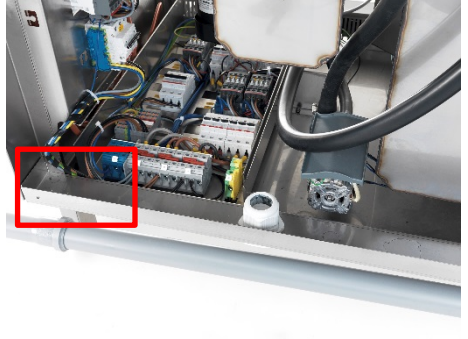
Left and right at the sides of the machine	Left and right at the rear of the machine
	
6 hose connectors for inserting hoses and cables	3 perforations for the installation of screwed cable glands

Electrical connection







When connecting an external dosing device to the control board, there must be no short circuit. The control board can be destroyed by a short circuit. Only connect external dosing devices with their own fuse protection.

IMPORTANT Maximum current consumption at the transfer strip: 0.5 A.



➤ Connect the external dosing device to the 5-pin plug.

Assignment of the transfer strip

Terminal	Signal designation			
L	phase 1 / continuous voltage			
N	neutral line / phase 2			









Terminal	Voltage is on	Condition	Restriction	Setting
Rinse (O18)	parallel to rinse pump (O12)	a)	c), d)	 ext. = 0
	parallel to solenoid valve (O7) – while the machine is filling – during rinsing	a)	c)	 ext. = 1
Wash (O20)	while the circulating pump is running	a)	c), d)	
Fill (O17)	while the machine is filling	a), b)		 ext. = 0
	parallel to solenoid valve (O7) – while the machine is filling – during rinsing	a)	c)	 ext. = 1

- a) door closed
- b) minimum water level in the tank
- c) not in the self-cleaning programme
- d) not while the machine is filling











 ext.	Rinse aid dosing device
 ext.	Detergent dosing device

Programming settings

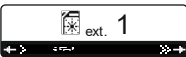
- Access the PIN Menu.

3x 		Enter PIN 1575. To do this, select the individual figures with the  and  buttons and confirm each figure with the  button.			
--	---	---	---	---	--

- Select settings for the detergent and rinse aid dosing device in the table on page 27.

	The setting for the detergent dosing device is displayed (number flashes). Confirm with the  button or select the value 0 with the  button and confirm with the  button.
	The setting is saved.
	The setting for the rinse aid dosing device is displayed (number flashes). Confirm with the  button or select the value 0 with the  button and confirm with the  button.
	The setting is saved.
	Press and hold the button to exit the menu.

23 Installing the machine and tables

Notes for the service technician or dealer authorised by Winterhalter:

- Observe the connection diagram for detailed information.
- The installation site must be frost-resistant so that the water systems do not freeze.

Installing the machine

INFO No gap is required between the wall and rear of machine.

- Install the machine horizontally with the help of spirit level.

Attaching tables

- Refer to the table connection drawing (on request).

24 Location of the connections on the machine

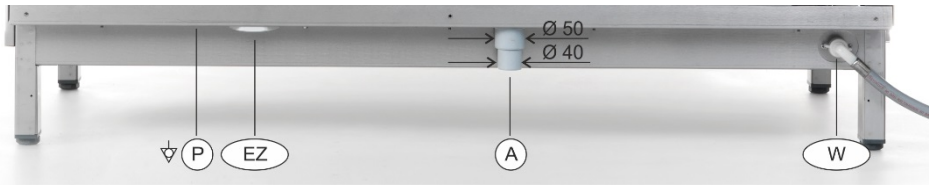

Rear view (independent of the pass-through direction)

EZ		Screwed cable gland for mains cable	
A		Waste water connection	Ø 40 mm / Ø 50 mm
W		Inlet water connection	G 3/4", external thread
P		Connection for on-site equipotential bonding system	

25 Water connection



Warning

The machine and any other relevant additional devices must be connected by an authorised specialist company in relation to local standards and regulations.

IMPORTANT Observe the connection diagram for detailed information.

Requirements for the on-site inlet water connection

Water quality	The inlet water must in microbiological aspects have the quality of drinking water
Inlet water temperature	10 - 60 °C
Water hardness	We recommend a maximum hardness of 3 °dH (3.8 °e / 5.34 °TH / 0.54 mmol/l) in order to prevent scaling in the machine.
Minimum flow pressure	150 kPa (1.5 bar)
Maximum inlet pressure (back pressure)	1000 kPa (10.0 bar)
Rate of flow	6 - 15 l/min The flow rate influences the tank filling time.

Requirements for the on-site water supply

- easily accessible
- not behind the machine
- 3/4" connector

Connecting the supply hose



Caution

- The hose may not be shortened or damaged.
- Old existing hoses may not be re-used.
- Do not bend the hose when laying it.

The supply hose and dirt trap are located in the machine.

INFO The dirt trap prevents particles from the water supply line entering the machine thus preventing extraneous rust on the cutlery and in the machine.

- Connect the supply hose to the machine.
- Connect the dirt trap to the on-site water supply.
- Connect the supply hose to the dirt trap.
- Open the water supply and test whether the connections are tight.

Waste water connection

- Connect the central water drain (A) to the drainage system in the building. The drain pipe in the building should have a diameter of at least 50 mm and a sufficient slope (min. 3°).
- The waste water connection in the building must be located at a max. height of 100 mm above the finished floor level. Alternatively, the waste water can be channeled into a floor drain.
- Install an odour trap into the drain pipe in the building.

26 Electrical connection



Danger

Danger to life. Live components.

- The machine and the relevant additional devices must be connected by an electrical company authorised by the relevant electricity supplier as per the locally applicable standards and regulations.
- When performing installation and maintenance work, unplug the machine from the power network. Check that there is no voltage.

IMPORTANT Observe the connection diagram for detailed information.

- The electrical safety of this machine is guaranteed only if it is connected to a correctly installed protective circuit. It is very important that this basic safety requirement is tested and in case of doubt the house installation is checked by a qualified electrician.
- The circuit diagram must be observed.
- The machine may only be operated at the voltages and frequencies specified on the rating plate.
- A mains disconnecter with all-pole separation from the network must be installed. The mains disconnecter switch must have a contact opening width of at least 3 mm, and must also be lockable in the neutral position. The installation site must be near the machine and easily accessible.
For Australia and New Zealand: the all-pole separation from the network must be in accordance with AS/NZS 3000 (AS/NZS 60335.1:2011/A3:2015).
- The electrical connection must be secured as a separately fused circuit with slow fuses or circuit breakers. The protection depends on the total power consumption of the machine. The total connected load is specified on the rating plate of the machine.

- We recommend to install a class B all-current sensitive residual current circuit breaker with a release current of 30 mA (DIN VDE 0664) in the electrical supply line.

Mains cable

- Select the cable cross section in accordance with the following table:

Standard

Mains supply	Drying zone	Total connected load	Current consumption	On-site fuse protection	Cable cross section
380 V-415 V, 3N~	without	43.7-51.6 kW	69.6-75.3 A	80 A	25 mm ²
380 V-415 V, 3N~	with	47.7-56.6 kW	75.0-81.4 A	100 A	35 mm ²
230 V, 3~	without	47.5 kW	122.7 A	125 A	50 mm ²
230 V, 3~	with	52.0 kW	136.5 A	160 A	70 mm ²

HighTemp

Mains supply	Drying zone	Total connected load	Current consumption	On-site fuse protection	Cable cross section
380 V-415 V, 3N~	without	51.9-61.4 kW	82.1-88.9 A	100 A	35 mm ²
380 V-415 V, 3N~	with	56.0-66.2 kW	87.5-95.0 A	100 A	35 mm ²
230 V, 3~	without	56.5 kW	145.3 A	160 A	70 mm ²
230 V, 3~	with	61.0 kW	159.1 A	160 A	70 mm ²

- The mains cable must be an oil-resistant, encased and flexible wire. We recommend the wire type H07RN-F.
- Pass the mains cable through the cable gland on the underside of the base plate.

- Connect the cable to the correct phases at the indicated connection terminals (N, L3, L2, L1, PE) so that the rotating field of all motors is clockwise.

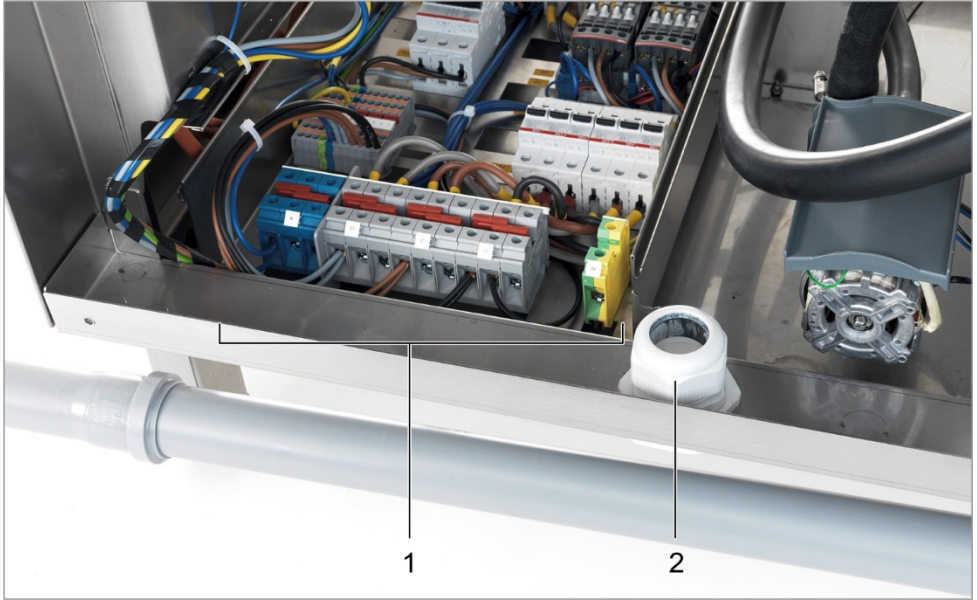

Item	Description
1	Connection terminals (N, L3, L2, L1, PE)
2	Cable gland for mains cable

INFO At 200 V or 230 V without a neutral conductor (N), the blue terminal is not available.

27 Technical data

General	
Minimum flow pressure	150 kPa (1.5 bar)
Maximum inlet pressure (back pressure)	1000 kPa (10.0 bar)
Inlet water temperature	10 – 60 °C
Voltage	see rating plate
Total connected load	
Fuse protection	

Operating conditions	
Operating temperature	0 - 40 °C
Relative humidity	< 95%
Storage temperature	> -10 °C
Maximum height of the installation location above sea level	3000 m

28 Emissions

Noise

Workplace-related emission sound pressure level $L_{pA} < 70$ dB

Measurement uncertainty: K(pA): 4 dB

Exhaust air

Adhere to the VDI Guideline 2052 when designing the ventilation system.

Recommended extraction volume per exhaust air vent* (depending on the environmental conditions): 350 - 700 m³/h

*) Optional

29 Disposal



Incorrect or negligent disposal can cause considerable environmental pollution and/or damage.

- For hazardous substances, please observe the disposal regulations listed in the safety data sheets.
- Disposal according to national regulations.

Winterhalter Gastronom GmbH
Commercial Dishwashing Systems

Winterhalterstrasse 2–12
88074 Meckenbeuren
Germany
Telephone +49 (0) 75 42/4 02-0

www.winterhalter.com
info@winterhalter.com